



Bentone STG120-146

Reservdelar och tillbehör
Spare parts and accessories
Ersatzteile und Zubehör
Pièces détachées et accessoires



Gäller från:
Valid from:
Gültig ab:
Valide du:

april 1997

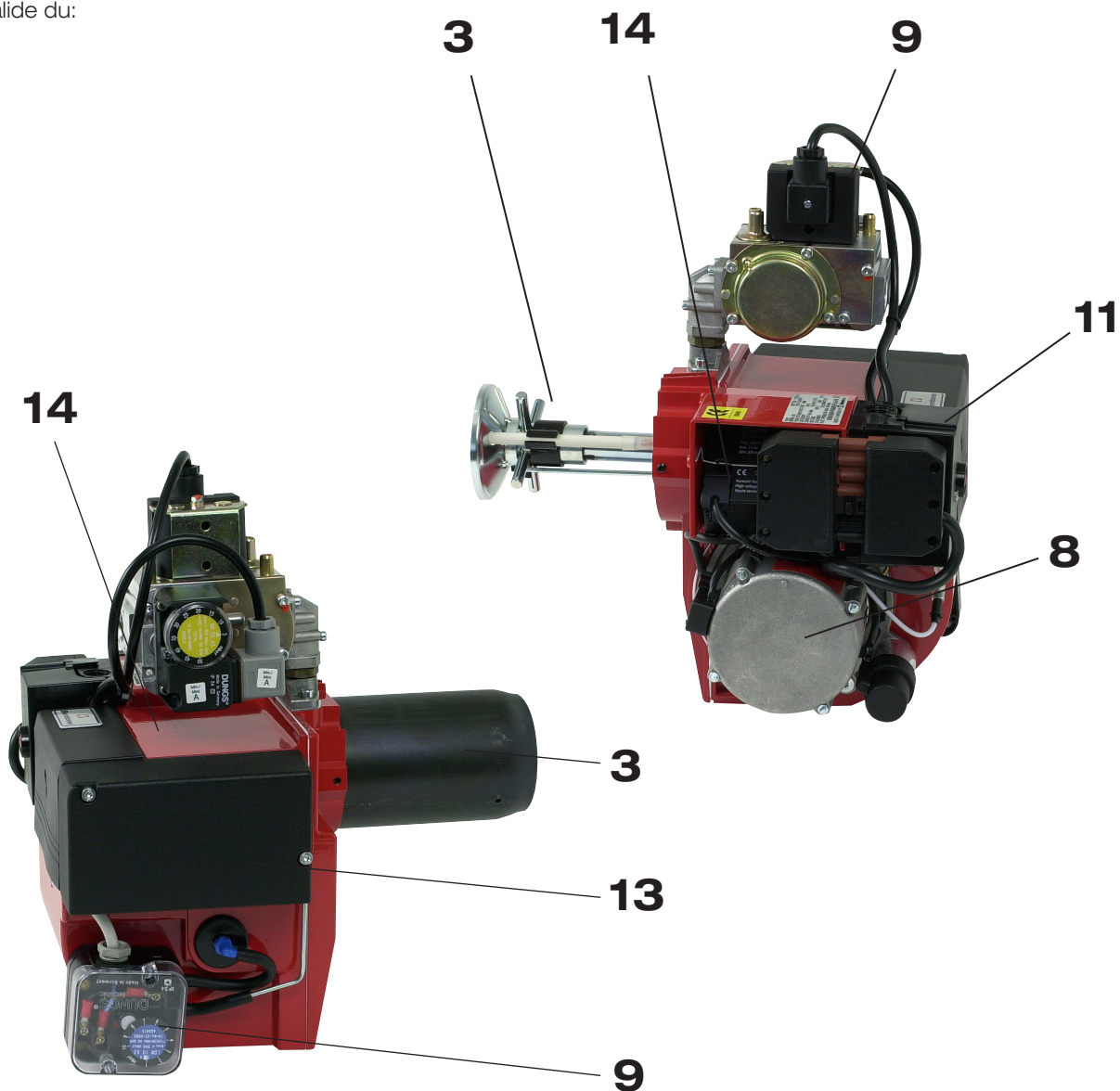

1. Brännarrör - Blast tube - Brennerrohr - Tube diffuseur	3
2. Insats • Nozzle Assembly • Düsenstock • Ligne Porte-Gicleur	4
3. Anslutningsfläns • Fixing flange • Anschlussflansch • Bridge de fixation	7
4. Motor • Motor • Motor • Moteur	8
5. Gaskomponenter • Gas components • Gaskomponenten • Composants de gaz	9
6. Eldningsautomat • Oil burner control • Feuerungsautomat • Contrôle du brûleur	11
7. Transformator • Transformer • Transformator • Transformateur	12
8. Luftreglering • Air regulation • Luftregelung • Régularisation à air	13
9. Fläkthus • Fan housing • Brennergehäuse • Carter du rotor	14

1. Brännarrör - Blast tube - Brennerrohr - Tube diffuseur



Brännarrör

Burner tube

Brennerrohr

Tube diffuseur

STG146

145 mm
245 mm

11751705
11751706



Brännarrör C

Burner tube

Brennerrohr

Tube diffuseur

11738515

108 mm



Brännarrör KA

Burner tube KA

Brennerrohr KA







Tube diffuseur KA

STG120











115 mm

11728410

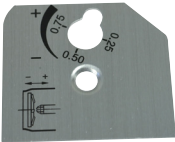
2. Insats • Nozzle Assembly • Düsenstock • Ligne Porte-Gicleur

	Insats kpl KA STG120	Inner assembly	Gasdüsenstock	Ligne porte-gicleur	11939701
	Insats kpl C	Inner assembly	Gasdüsenstock	Ligne porte-gicleur	119 398 01
	Insats kpl STG146	Inner assembly	Gasdüsenstock	Ligne portegicleur	11938501
	Bromsskiva KA STG120	Brake plate	Stauscheibe	Disque accroche-flamme	11916901
	Bromsskiva C	Brake plate	Stauscheibe	Disque accroche-flamme	11790901
	Bromsskiva STG146	Brake plate	Stauscheibe	Disque accroche-flamme	91941801
	Tändelektrod STG120 STG146	Ignition electrode	Zündelektrode	Electrode d'allumage	11534708 11534704
	Joniseringselektrod STG120 STG146	Ionisation electrode	Ionisations elektrode	Electrode d'ionisation	11534707 11534703
	Munstycke STG120 STG146	Nozzle	Düse	Gicleur	11786803 11796803
	O-ring Ø 17 x 1,6mm STG120-146 Ø 23,52 x 1,78mm STG146	O-ring	O-Ring	Rondelle	11316821 11316801

Insats • Nozzle Assembly • Düsenstock • Ligne Porte-Gicleur

	Klammer STG146	Bracket	Klammer	Crampon	11273802
	Klammer	Bracket	Klammer	Crampon	11490902
	Klammer	Bracket	Klammer	Crampon	11490903
	Elektrodhållare STG146	Electrode holder	Elektrodenhalter	Support d'électrode	11719602
	Täckplåt, insatsreglering STG120	Cover plate, nozzle assembly adjustment	Deckplatte, Düsenstock- einstellung	Plaque de recouvrement, ligne porte-gicleur	12051401
	Täckplåt, insatsreglering STG146	Cover plate, nozzle assembly adjustment	Deckplatte, Düsenstock- einstellung	Plaque de recouvrement, ligne porte-gicleur	12051402
	Skala, insatsreglering STG120 STG146	Scale, nozzle assembly adjustment	Skala, Düsenstock- einstellung	Echelle, ligne porte-gicleur	11888101 12071002
	Gavel	Front plate	Frontplatte	Plaque frontale	11906401
	Ställskruv STG120 STG146	Adjustment screw	Stellschraube	Vis de réglage	12071701 12071702
	Bussning	Bushing	Buchse	Douille	11847901

Insats • Nozzle Assembly • Düsenstock • Ligne Porte-Gicleur



Luftfördelare

Air distributor

Luftverteiler

Distributeur d'air

11485502



Stabiliseringsring,
insats

Stabilizing ring,
nozzle assembly

Stabilisierungsring,
Düsenstock

Anneau de
stabilisation,
ligne porte-gicleur

11754701

STG146

Axel,
elektrodhållare

Axle,
electrode holder

Achse,
Elektrodenhalter

Arbre, support
d'électrode

11925301

STG146



Dragstång

Pull rod

Zugstange

Tirant

STG146

130 mm

142 mm

11903501

11903503

STG120

110 mm

230 mm

11901801

11901802

Ställskruv

Adjustment screw

Stellschraube

Vis de réglage

11901901

3. Anslutningsfläns • Fixing flange • Anschlussflansch • Bride de fixation



Anslutningsfläns
STG120

Fixing flange

Anschlussflansch

Bride de fixation

11883001



Anslutningsfläns
STG120

Fixing flange

Anschlussflansch

Bride de fixation

11824601



Anslutningsfläns
STG146

Fixing flange

Anschlussflansch

Bride de fixation

12114601



Strypring
STG146

Reduction ring

Reduziererring

Anneau de réduction

11903801

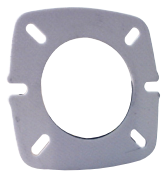

Packning

Gasket

Dichtung

Joint

11739801



Packning

Gasket

Dichtung

Joint

11883101



Packning
STG120

Gasket

Dichtung

Joint

11819101

4. Motor • Motor • Motor • Moteur

	Motor 125W, 1F, 230V, 50/60Hz, 4uF med kabel L=360 STG146	Motor with cable	Motor mit Kabel	Moteur avec Câble	12090001 92090001
	Motor 90W, 1F, 230V, 50/60Hz, 4uF med kabel L=360 STG120	Motor with cable	Motor mit Kabel	Moteur avec Câble	12090401 92090401
	Motor 90W, 1F, 230V, 50Hz, 3uF med kabel L=435 STG120	Motor with cable	Motor mit Kabel	Moteur avec Câble	12090501 92090501
	Fläns STG146	Flange	Flansch	Bride	11700902
	Kondensator 3uF 4uF	Capacitor	Kondensator	Condensateur	12093301 12093001
	Fläkthjul STG120 Ø146x52 STG146 Ø120x42	Fan wheel	Gebälserad	Rotor	11417601 11872601
	Kabel L=360 L=435	Cable	Kabel	Câble	12086602 12086601
	Packning STG146	Gasket	Dichtung	Joint	11874201
	O-ring, nitril 145,29 x 1,78 STG146	O-ring, nitril	O-ring, Nitril	Rondelle, nitril	11316842

5. Gaskomponenter • Gas components • Gaskomponenten • Composants de gaz

	Multiblock MB-DLE 403 407	MultiBloc	MultiBloc	MultiBloc	11563207 11567071
	Multiblock MB-VEF 407	MultiBloc	MultiBloc	MultiBloc	11851102
	Filter MBDLE 405/407 MBZRDLE 405/407 MBVEF 405/407	Filter	Filter	Filtre	11916411
	Multiblock GB-LD 055	MultiBloc	MultiBloc	MultiBloc	12034101
	Multiblock GVC 15	MultiBloc	MultiBloc	MultiBloc	12075401
	Fläns För MB 403	Flange	Flansch	Bride	11556701
	Fläns R $\frac{1}{2}$ plugg	Flange	Flansch	Bride	11566703
	Impulsfläns MB-VEF 407	Impulse Flange	Impulse Flansch	Bride Impulse	11968401
	Vinkelfläns R $\frac{1}{2}$ "	Angle Flange	Angle Flansch	Angle bride	11930702



Mellanfläns	Intermediate flange	Zwischenflansch	Bride intermédiaire	11909201
-------------	---------------------	-----------------	---------------------	----------



Tryckvakt	Pressure switch	Druckwächter	Pressostat	
LGW10A2				11531906
GW50A5				11531926





Magnetventil kpl. kontinuerlig fläkt	Solenoid valve cpl. continuous fan	Magnetventil kpl. kontinuerliches Gebläse	Electrovanne cpl. ventilation continue	11923002
---	---------------------------------------	---	---	----------





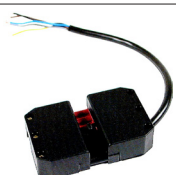

O-ring	O-ring,	O-ring, Nitril	Rondelle, nitril	
Nitril 15,54 x 2,62	Nitrile	Nitril	Nitrile	11316823
29,2 x 3				11316846

6. Eldningsautomat • Oil burner control • Feuerungsautomat • Contrôle du brûleur

	Reläbox LME11	Control box	Steuergerät	Boîte de contrôle	92070001
	Reläsocket LGB, LMG, LME	Relay base	Unterteil	Socle	91559600
	Kontaktton 7-pol hondel 7-pol handel	Plug-in-contact 7-pole female 7-pole male	Stecker und Buchsentteil Buchsentteil 7-polig Steckerteil 7-polig	Conecteur femelle, 7 polaire mâle, 7 polaire	91558501 11558500





7. Transformator • Transformer • Transformator • Transformateur

	Transformator	Transformer	Transformator	Transformateur	12064401
	Med kabel 250 mm	With cable	Mit Kabel	Avec câble	92064401
	Kabel 250 mm	Cable	Kabel	Câble	12062003
	Fästfjäder	Fixing spring	Befestigungs feder	Ressort de fixation	11855801
	Tänd/ Joniseringskabel 250mm. 350mm.	Ignition/ Ionisation cable	Zünd/ Jonisationskabel	Câble d'allumage/ ionisation	12068825 12068835
	Joniseringskabel	Ionisation cable	Jonisationskabel	Câbles d'ionisation	12118128

8. Luftreglering • Air regulation • Luftregelung • Régularisation à air

	Luftspjäll STG120 STG120	Air damper	Luftklappe	Volet d'air	11851001 11867501
	Luftregleringsplåt STG120 STG146	Air regulation plate	Luftteinstellplatte	Plaque de réglage d'air	11852201 11867401
	Ställskruv	Adjustment screw	Stellschraube	Vis de réglage	12070901
	Bussning	Bushing	Buchse	Douille	11847901
	Skala	Scale	Skala	Echelle	12071101
	Täckplåt STG120 STG146	Cover plate	Deckplatte	Plaque de recouvrement	11887001 11887401
	Slangnippel V4 x 1/8"	Hose nipple	Schlauchnippel	Raccord de tuyau flexible	11575301
	Förbindelserör, trycksond STG120 STG146	Connecting pipe, pressure probe	Verbindungsrohr, Drucksonde	Trompette, sonde de pression	11900801 11900802

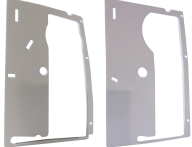
9. Fläkthus • Fan housing • Brennergehäuse • Carter du rotor

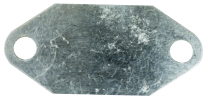
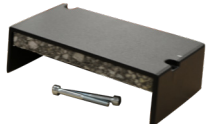
	Fläkthusdel, bakre	Fan housing rear part	Brennergehäuse hinterer Teil	Carter du rotor partie arrière	
	STG120 röd vit	red white	rot weiß	rouge blanc	1199110227 1199110211
	Fläkthusdel, främre	Fan housing front part	Brennergehäuse vorderer Teil	Carter du rotor partie frontale	
	STG120 röd vit	red white	rot weiß	rouge blanc	1189880227 1189880211
	Avskärningsvägg	Shielding arrangement	Abschirmung	Ecran de partition	
	STG120 STG146				11849601 11863201
	Packning	Gasket	Dichtung	Joint	
	STG120 STG146				11854401 11867001
	Täcklock	Cover plate	Deckplatte	Plaque de recouvrement	11850001
	Skruv	Screw	Schraube	Vis	11750702
	Lock	Cover	Deckel	Couvercle	11173106
	Ljuddämpare	Silencer	Schalldämpfer	Silencieux	
	STG120 STG146				91879302 1198490105



