

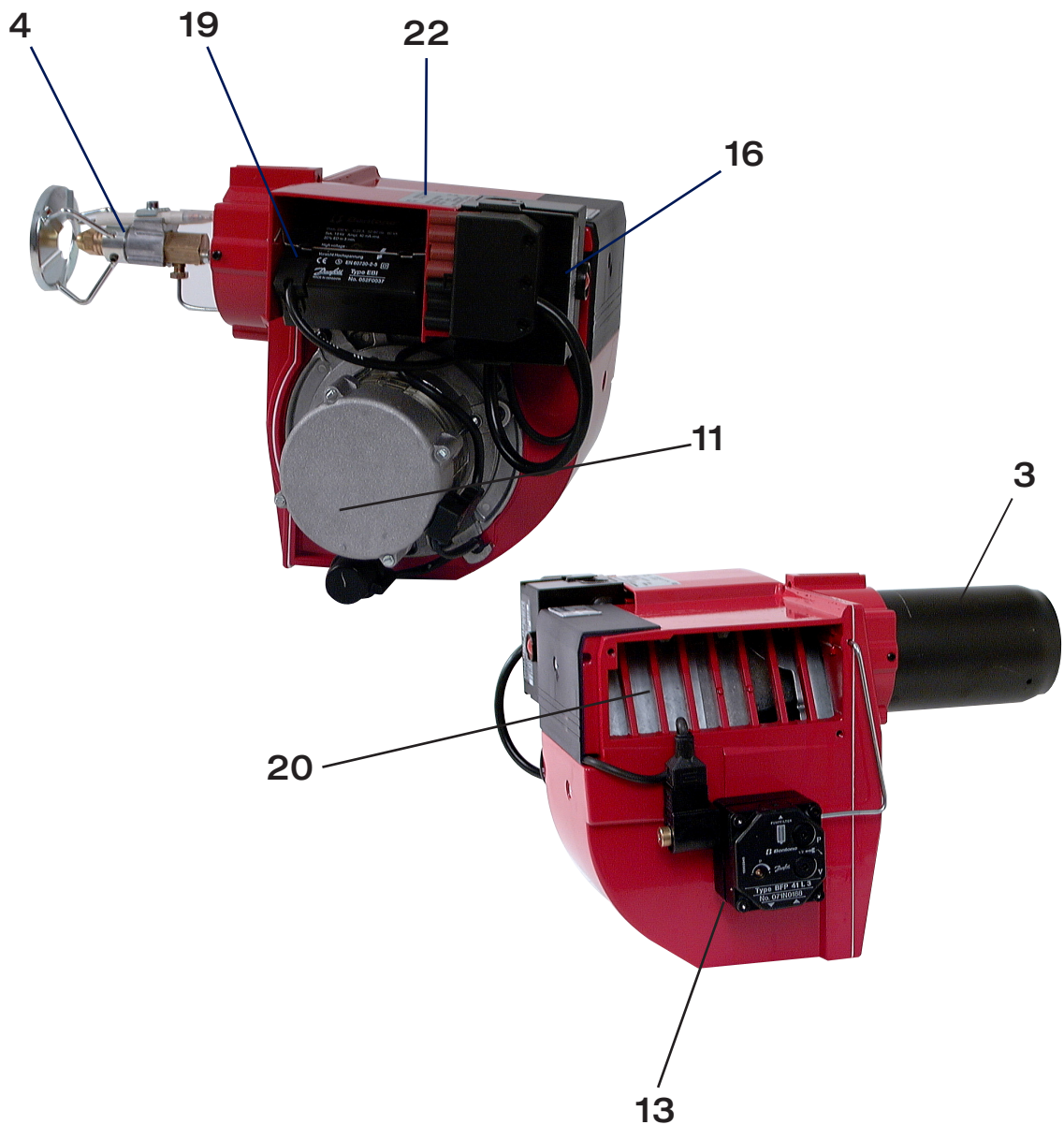





Providing sustainable energy solutions worldwide

Bentone ST 97-146









Reservdelar och tillbehör
Spare parts and accessories
Ersatzteile und Zubehör
Pièces détachées et accessoires



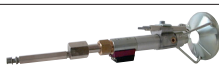





Reservdelar och tillbehör	1
Brännarrör • Blast tube • Brennerrohr • Tube diffuseur	3
Insats • Nozzle Assembly • Düsenstock • Ligne Porte-Gicleur	4
Anslutningsfläns • Fixing flange • Anschlussflansch • Bridge de fixation	9
Motor • Motor • Motor • Moteur	11
Pump • Pump • Pumpe • Pompe	13
Eldningsautomat • Oil burner control • Feuerungsautomat • Contrôle du brûleur	16
Transformator • Transformer • Transformator • Transformateur	19
Luftreglering • Air regulation • Luftregelung • Régularisation à air	20
Fläkthus • Fan housing • Brennergehäuse • Carter du rotor	22
Övrigt • Sundries • Verschiedenes • Divers	23

	Brännarrör PL ST97 - ST120 80 mm 10-4-24-10 10-5-16-8 10-8-10-6-19-10 127 mm 10-8-10-6-19-10	Blast tube	Brennerrohr	Tube diffuseur	11780201 11780305 11780401 11780402
	Brännarrör PL ST97 - ST120 80 mm 6-7-21,5-10 6-7-19-10 127 mm 6-7-19-10 157 mm 6-7-19-8 6-7-16-8	Blast tube	Brennerrohr	Tube diffuseur	11780103 11780105 11780106 11780111 11780109
	Brännarrör K, KA 94 mm 147 mm ST133, ST146 224 mm	Blast tube	Brennerrohr	Tube diffuseur	11728401 11728402 11728403
	Brännarrör E ST97 - ST120 87 mm 124 mm	Blast tube	Brennerrohr	Tube diffuseur	11934003 11934005
	Brännarrör FU ST97 - ST120 103 mm 133 mm	Blast tube	Brennerrohr	Tube diffuseur	11764301 11764304
	Brännarrör F, FV 127 mm ST97 - ST120	Blast tube	Brennerrohr	Tube diffuseur	11591401
	Brännarrör C 94 mm ST133, ST146 224 mm	Blast tube	Brennerrohr	Tube diffuseur	11738514 11738506
	Brännarrör E värmebeständigt ST97 - ST120 87 mm 215 mm	Blast tube heat resistant	Brennerrohr hitzebeständig	Tube diffuseur résistant à la chaleur	11934004 11934010
	Brännarrör ST146/2 263 mm 163 mm	Blast tube	Brennerrohr	Tube diffuseur	1192310305 1192310205





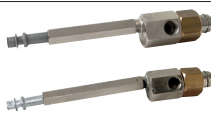



Insats • Nozzle Assembly • Düsenstock • Ligne Porte-Gicleur

	Insats För brännarrör	Nozzle assembly For burner tube	Düsenstock Für Brennerrohr	Ligne porte-gicleur Pour tube diffuseur	
	ST97 FUV 103 mm				11894301
	ST108 FV 127mm FUV 133 mm				11894301 11894302
	Insats ST133 - 146 För brännarrör	Nozzle assembly For burner tube	Düsenstock Für Brennerrohr	Ligne porte-gicleur Pour tube diffuseur	
	K 94 mm 147 mm				11906001 11906002
	KA 147 mm 224 mm				11906005 11906009
	Insats ST133 - 146 För brännarrör	Nozzle assembly For burner tube	Düsenstock Für Brennerrohr	Ligne porte-gicleur Pour tube diffuseur	
	KAV 94 mm 224 mm				11906104 11906106
	ST120 KAV 147 mm				11907505
	Insats ST120 För brännarrör	Nozzle assembly For burner tube	Düsenstock Für Brennerrohr	Ligne porte-gicleur Pour tube diffuseur	
	KA, C 94 mm 147 mm				11894501 11894502
	Insats ST120 För brännarrör	Nozzle assembly For burner tube	Düsenstock Für Brennerrohr	Ligne porte-gicleur Pour tube diffuseur	
	E, EM 87 mm				11861601
	E 124 mm 215 mm				11861602 11861604
	PL 80 mm 127 mm				11861601 11861602
	Insats ST97- 108 För brännarrör	Nozzle assembly For burner tube	Düsenstock Für Brennerrohr	Ligne porte-gicleur Pour tube diffuseur	
	PLV 127 mm				11894402
	Insats ST120 Förvärmare 127 mm	Nozzle assembly Preheater	Düsenstock Vorwärmer	Ligne porte-gicleur Péchauffeur	
					11894602

Insats • Nozzle Assembly • Düsenstock • Ligne Porte-Gicleur

	Insats ST146/2 För brännarrör	Nozzle assembly For burner tube	Düsenstock Für Brennerrohr	Ligne porte-gicleur Pour tube diffuseur	
	163 mm 263 mm				11906006 11906007
	Oljerör ST97 - 120 För brännarrör	Nozzle line For burner tube	Düsenrohr Für Brennerrohr	Canne porte-gicleur Pour tube diffuseur	
	E, EM 87 mm				12071314
	E 124 mm 212 mm				12071302 12071304
	Oljerör ST108 För brännarrör	Nozzle line For burner tube	Düsenrohr Für Brennerrohr	Canne porte-gicleur Pour tube diffuseur	
	FU 103 mm				12071302
	Oljerör ST97 - 108 För brännarrör	Nozzle line For burner tube	Düsenrohr Für Brennerrohr	Canne porte-gicleur Pour tube diffuseur	
	FUV 103 mm				12071401
	ST108 FUV 133 mm				12071407
	Oljerör För brännarrör	Nozzle line For burner tube	Düsenrohr Für Brennerrohr	Canne porte-gicleur Pour tube diffuseur	
	K, KA, C				
	ST97 - 120 94 mm				12071307
	ST133 - 146 94 mm 147 mm 224 mm				12071305 12071306 12071309
	Oljerör För brännarrör	Nozzle line For burner tube	Düsenrohr Für Brennerrohr	Canne porte-gicleur Pour tube diffuseur	
	KAV				
	ST97 - 120 147 mm				12071408
	ST133 - 146 94 mm 224 mm				12071405 12071403
	Oljerör ST97 - 108 För brännarrör	Nozzle line For burner tube	Düsenrohr Für Brennerrohr	Canne porte-gicleur Pour tube diffuseur	
	PL 80 mm 127 mm				12071314 12071302





Insats • Nozzle Assembly • Düsenstock • Ligne Porte-Gicleur

	Oljerör För brännarrör PLV	Nozzle line For burner tube	Düsenrohr Für Brennerrohr	Canne porte-gicleur Pour tube diffuseur	
	ST97 - 108 127 mm				12071401
	ST120 127 mm				12071403
	Oljerör För brännarrör	Nozzle line For burner tube	Düsenrohr Für Brennerrohr	Canne porte-gicleur Pour tube diffuseur	
	B146/2 163 mm 263 mm				12071306 12071308
	Fövärmare	Preheater	Vorwärmer	Réchauffeur	12086705
	Kabel, fövärmare 400 mm	Cable, preheater	Kabel, Vorwärmer	Cable, réchauffeur	11477706
	Elektrodhållare	Electrode holder	Elektrodenhalter	Porte-électrode	11598401
	Tändelektrod ST97 - 145	Ignition electrode	Zündelektrode	Electrode 'aiiumage	11593701
	Par	Pair of	Paar	1 Paire	91593701
	Tändelektrod ST146/2	Ignition electrode	Zündelektrode	Electrode 'aiiumage	11924301
	Par	Pair of	Paar	1 Paire	91924301
	Dubbelektrod ST97 - 120	Double electrode	Doppelelektrode	Electrode double	11886701
	Tändelektrodsats	ignition electrode set	Zündelektrode satz	Electrode 'aiiumage ensemble	12111901







Insats • Nozzle Assembly • Düsenstock • Ligne Porte-Gicleur

	Bromsskivaesats ST97 - 120 FU, FUV	Brake plate	Stauscheibe	Disque accroche-flamme	11591501
	Bromsskiva ST146/2	Brake plate	Stauscheibe	Disque accroche-flamme	11887102
	Bromsskiva ST97 - 120 FUV	Brake plate	Stauscheibe	Disque accroche-flamme	11591202
	Bromsskiva ST120 - 146 KA, KAV	Brake plate	Stauscheibe	Disque accroche-flamme	11885801
	Bromsskiva ST133 - 146 K, KV	Brake plate	Stauscheibe	Disque accroche-flamme	11731701
	Skala, insatsreglering ST97 - 146	Scale, nozzle assembly adjustment	Skala, Düsenstock- einstellung	Echelle, ligne porte-gicleur	12071001
	Skala, insatsreglering ST146/2	Scale, nozzle assembly adjustment	Skala, Düsenstock- einstellung	Echelle, ligne porte-gicleur	12071002
	Täckplåt, insatsreglering ST97 - 146	Cover plate, nozzle assembly adjustment	Deckplatte, Düsenstock- einstellung	Plaque de recouvrement, ligne porte-gicleur	12071001
	ST97 - 133				12056601
	Täckplåt, insatsreglering ST146/2	Cover plate, nozzle assembly adjustment	Deckplatte, Düsenstock- einstellung	Plaque de recouvrement, ligne porte-gicleur	12051402

Insats • Nozzle Assembly • Düsenstock • Ligne Porte-Gicleur

	Ställskruv, insats	Adjustment screw, nozzle assembly	Stellschraube, Düsenstock	Vis de réglage, ligne porte-gicleur	12070801
	Distansrör	Spacing tube	Abstandsrohr	Tube d' écartement	11741601
	Bussning	Bushing	Buchse	Douille	11847901
	O-ring, förvärmare	O-ring, preheater	O-ring, Vorwärmer	Joint torique, réchauffeur	11316802
	Låsring, förvärmare	Locking ring, preheater	Sicherungsring, Vorwärmer	Circlip, réchauffeur	11801802









Anslutningsfläns • Fixing flange • Anschlussflansch • Bride de fixation

	Anslutningsfläns	Fixing flange	Anschlussflansch	Bride de fixation	11883001
	Anslutningsfläns	Fixing flange	Anschlussflansch	Bride de fixation	11811601
	Anslutningsfläns	Fixing flange	Anschlussflansch	Bride de fixation	11854501
	Anslutningsfläns ST97 - 120	Fixing flange	Anschlussflansch	Bride de fixation	0439030834
	Anslutningsfläns ST97 - 120	Fixing flange	Anschlussflansch	Bride de fixation	11852501
	Anslutningsfläns ST133 - 146	Fixing flange	Anschlussflansch	Bride de fixation	11904001



Anslutningsfläns • Fixing flange • Anschlussflansch • Bridge de fixation







	Packning	Gasket	Dichtung	Joint	11854201
	Packning	Gasket	Dichtung	Joint	11819101
	Packning	Gasket	Dichtung	Joint	11854301
	Packning	Gasket	Dichtung	Joint	11883101
	Packning ST97 - 120	Gasket	Dichtung	Joint	0439012027
	Packning ST97 - 120	Gasket	Dichtung	Joint	11875603
	Packning ST133 - 146	Gasket	Dichtung	Joint	11739801
	Packning ST146/2	Gasket	Dichtung	Joint	11903801

	Motor 90W, 4µF 3µF	Motor	Motor	Moteur	92090401 92090501
	Fläkt hjul ST97 97 x 42 x 8 ST108 108 x 42 x 8 ST120 120 x 42 x 8	Fan wheel	Gebälserad	Rotor	11417603 11417604 11417601
	Drivkoppling	Drive coupling	Antriebskupplung	Accouplement d'entraînement	11407210
	O-ring 121,0 x 1,6	O-ring 121,0 x 1,6	O-Ring 121,0 x 1,6	Joint torique 121,0 x 1,6	11316851
	Kondensator 3µF 4µF	Capacitor	Kondensator	Condensateur	12093301 12093001
	Kabel	Cable	Kabel	Câble	11703404

	Motor 125W	Motor	Motor	Moteur	92090001
	Fläktjul ST133 133*52*8 ST146 146*52*8	Fan wheel	Gebläserad	Rotor	11867101 11872601
	Drivkoppling	Drive coupling	Antriebskupplung	Accouplement d'entraînement	11127823
	O-ring 121,0 x 1,6	O-ring	O-Ring	Joint torique	11316841
	Kondensator 3µF	Capacitor	Kondensator	Condensateur	12093301
	Kabel	Cable	Kabel	Câble	11703404
	Packing	Gasket	Dichtung	Joint	11874201
	Fläns	Flange	Flansch	Bride	11700902

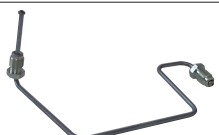

	Pump, BFP11L3 Med kabel	Pump With cable	Pumpe Mit Kabel	Pompe Avec câble	92074002
	Pump, BFP41L3 Med kabel	Pump With cable	Pumpe Mit Kabel	Pompe Avec câble	92074001
	Magnetventil, BFP Innerdel	Solenoid valve Inner part	Magnetventil Einsatz	Electrovanne Partie interieure	11597303 11774201
	Spole, BFP	Coil	Spule	Bobine	11597404
	Kabel, BFP 400 mm	Cable	Kabel	Câble	11597505
	Filter, BFP41L3	Filter	Filter	Filtre	11774901
	Packning, lock BFP	Gasket, cover	Dichtung, Deckel	Joint, couvercle	11981001

	Pump, AS47C-6P ST97 - 146	Pump	Pumpe	Pompe	12026432
	2-rörs Styckförpackning	2-pipe Single-piece package	2-Rohr Stückverpackung	2 tuyaux Emballage par pièces	82026432
	Med kabel	With cable	Mit Kabel	Avec câble	92026432
	Pump, AS47C-6M ST97 - 120	Pump	Pumpe	Pompe	12026431
	1-rörs Styckförpackning	1-pipe Single-piece package	1-Rohr Stückverpackung	1 tuyau Emballage par pièces	82026431
	Med kabel	With cable	Mit Kabel	avec câble	92026431
	Spole, AS47C	Coil	Spule	Bobine	91597101
	Magnetventil, AS47C	Solenoid valve	Magnetventil	Electrovanne	91597201
	Kabel, AS47C 400 mm	Cable	Kabel	Câble	11597505
	Magnetventil, 1/8" SL1, Suntec	Solenoid valve, 1/8" SL1, Suntec	Magnetventil, 1/8" SL1, Suntec	Electrovanne, 1/8" SL1, Suntec	12119401
	Kabel, Danf 900 mm	Cable	Kabel	Câble	11597506
	Filter, AS47C	Filter	Filter	Filtre	11457002
	Packing, lock AS47C-4P AS47C-5M	Gasket, cover	Dichtung, Deckel	Joint, couvercle	11456601
	Packing, lock AS47C-6P AS47C-6M	Gasket, cover	Dichtung, Deckel	Joint, couvercle	11456602





	Förbindelserör ST97 - 108 FU103mm PL 80 mm PL 127, 157 mm	Connecting pipe	Öldruckrohr	Trompette	11863801 11884501
	Förbindelserör ST120 E 215 mm K 147 mm	Connecting pipe	Öldruckrohr	Trompette	11881901 11881902
	Förbindelserör ST120 K 94 mm	Connecting pipe	Öldruckrohr	Trompette	11855101
	Förbindelserör K, KA, C 94 mm 147 mm ST133/ST146/2	Connecting pipe	Öldruckrohr	Trompette	11874801 11874802 11874804
	Förbindelserör FUV, PLV 127mm	Connecting pipe	Öldruckrohr	Trompette	11869502
	Nippel, manometer	Nipple, pressure gauge	Nippel, Manometer	Raccord, manomètre	11860701







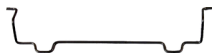

	Reläbox TF 832.3 Styckförpackning	Control box	Steuergerät Oberteil	Boite de contrôle	11781007 91781007
	Reläbox TF 834E.3 ST97 - 120 Styckförpackning	Control box	Steuergerät Oberteil	Boite de contrôle	11702704 91702704
	Reläsocket TF för kallstart ST97 - 120	Relay base for cold start	Steuergerät Unterteil für Kaltstart	Socle de raccordement pour démarrage à froid	11801204
	Reläsocket TF	Relay base	Steuergerät Unterteil	Socle de raccordement	91991001
	Fläns TF, fotomotstånd ST97 - 120	Flange, photoresistor	Flansch, Fotowiderstand	Bride, cellule photorésistante	39011302
	Fläns TF, fotomotstånd ST133 - 146	Flange, photoresistor	Flansch, Fotowiderstand	Bride, cellule photorésistante	39011303
	Fotomotstånd TF MZ770S	Photoresistor	Fotowiderstand	Cellule photorésistante	
	långt utförande kort utförande	long design short design	lange Ausführung kurze Ausführung	longue courte	11800301 11800303

	Reläbox LOA 24	Control box	Steuergerät Oberteil	Boîte de contrôle	11559504
	Styckförpackning	Single-piece package	Stückverpackung	Emballage par pièces	91559504
	Reläbox LMO14.113C2E	Control box LMO14.113C2E	Steuergerät LMO14.113C2E	Boîte de contrôle LMO14.113C2E	12000102
	Industriförpackning styckförpackning	Industrial package single-piece package	Industrie-verpackung stückverpackung	Emballage industriel emballage par pièces	92000102
	Reläsockel	Relay base	Steuergerät Unterteil	Socle de raccordement	91559600
	Fläns, fotomotstånd	Flange, photoresistor	Flansch, Fotowiderstand	Bride, cellule photorésistante	11776801
	Fotomotstånd QRB1B t.o.m serienummer ST108- 2499794 ST120- 2501093 ST133- 2499824 ST146- 2499866	Photoresistor QRB1B up to serial number ST108- 2499794 ST120- 2501093 ST133- 2499824 ST146- 2499866	Fotowiderstand QRB1B bis zur Seriennummer ST108- 2499794 ST120- 2501093 ST133- 2499824 ST146- 2499866	Cellule photorésistante, QRB1B jusqu'au numéro de série ST108- 2499794 ST120- 2501093 ST133- 2499824 ST146- 2499866	
	kort utförande	short design	kurze Ausführung	courte	91240905
	långt utförande	long design	lange Ausführung	longue	91240907
	Fotomotstånd till brännare med LOA från serienummer ST108- 2499795 ST120- 2501094 ST133- 2499825 ST146- 2499867 QRB1 340mm	Photoresistor for burners with LOA from serialnumber ST108- 2499795 ST120- 2501094 ST133- 2499825 ST146- 2499867 QRB1 340mm	Fotowiderstand für Brenner mit LOA von der Seriennummer ST108- 2499795 ST120- 2501094 ST133- 2499825 ST146- 2499867 QRB1 340mm	Cellule photorésistante pour les brûleurs avec LOA à partir du numéro de série ST108- 2499795 ST120- 2501094 ST133- 2499825 ST146- 2499867 QRB1 340mm	11992402





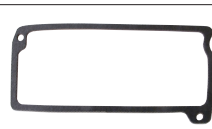

	<p>Fotomotstånd till brännare med LOA från serienummer ST108- 2499795 ST120- 2501094 ST133- 2499825 ST146- 2499867 QRB1 305mm</p>	<p>Photoresistor for burners with LOA from serialnumber ST108- 2499795 ST120- 2501094 ST133- 2499825 ST146- 2499867 QRB1 305mm</p>	<p>Fotowiderstand für Brenner mit LOA von der Seriennummer ST108- 2499795 ST120- 2501094 ST133- 2499825 ST146- 2499867 QRB1 305mm</p>	<p>Cellule photorésistante pour les brûleurs avec LOA à partir du numéro de série ST108- 2499795 ST120- 2501094 ST133- 2499825 ST146- 2499867 QRB1 305mm</p>	12070701
	<p>Flamdetektor till brännare med LMO/LMV från serienummer ST108- 2499795 ST120- 2501094 ST133- 2499825 ST146- 2499867</p>	<p>Flame detector for burners with LMO/LMV from serialnumber ST108- 2499795 ST120- 2501094 ST133- 2499825 ST146- 2499867</p>	<p>Flammendetektor für Brenner mit LMO/LMV von der Seriennummer ST108- 2499795 ST120- 2501094 ST133- 2499825 ST146- 2499867</p>	<p>Détecteur de flamme pour les brûleurs avec LMO/LMV à partir du numéro de série ST108- 2499795 ST120- 2501094 ST133- 2499825 ST146- 2499867 QRB4B-B036B40 L=250</p>	12119641
	<p>Packning, fotomotstånd</p>	<p>Gasket, photoresistor</p>	<p>Dichtung, Fotowiderstand</p>	<p>Joint, cellule photorésistante</p>	11856001







Transformator • Transformer • Transformator • Transformateur

	Kontaktblock, 7-pol med kåpa och kabel 370 mm	Plug-in contact, female 7-pole with cover and cable	Buchsenteil 7-polig mit Kasten und Kabel	Prise "européenne", femelle 7-polaire avec Capot et câble	91558608
	Utan kabel	Without cable	ohne Kabel	sans câble	91558501
	Kontaktblock, 7-pol	Plug-in contact, male 7-pole	Steckerteil 7-polig	Prise "européenne", mâle 7-polaire	11558500
	Kabelgenomföring	Cable inlet	Kabeldurchführung	Douille de passage câble	11810001
	Transformator Danfoss EBI	Transformer Danfoss EBI	Transformator Danfoss EBI	Transformateur Danfoss EBI	12064301
	Styckförpackning	Single piece package	Stückverpackung	Emballage par pièce	92064301
	Kabelgenomföring	Cable inlet	Kabeldurchführung	Douille de Câble H.T.	11990901

	Fästhjäder, transformator	Fixing spring, transformer	Befestigungsfeder, Transformator	Ressort de fixation, transformateur	11855801
	Tändkabelpar L=300 L=400	Pair of ignition cable	Zündkabelpaar	Câble H.T. 1 paire	12068730 12068740
	Kabel, transformator 300 mm 500 mm	Cable, transformer	Kabel, Transformator	Câble, transformateur	12062005 12062004
	Anslutningsstos ST97 - ST120	Connecting piece	Anschluss-Stück	Pièce de raccordement	91859104
	Anslutningsstos front entry ST97 - ST120	Connection piece front entry	Anschluss-Stück front entry	Pièce de raccordement. front entry	91859107
	Anslutningsstos ST133 - ST146	Connecting piece	Anschluss-Stück	Pièce de raccordement	91859105
	Ljuddämpare, Med ram för självstängande luftspjäll ST97 - ST120	Silencer, With frame for automatic air damper:	Schalldämpfer, Mit Rahmen für Luft- ansaugvorrichtung:	Silencieux, Avec cadre pour clapet d'air automatique:	1187490105 918 838 02
	Ljuddämpare, ST133 - ST146	Silencer,	Schalldämpfer,	Silencieux,	1198490105
	Packning, anslutningsstos ST97 - ST120	Gasket, connecting piece	Dichtung, Anschluss-Stück	Joint, Pièce de raccordement	11854101
	Packning, anslutningsstos ST133 - ST146	Gasket, connecting piece	Dichtung, Anschluss-Stück	Joint, Pièce de raccordement	11905701

	Luftregleringsplåt ST97 - ST120	Air regulation plate	Lufteinstellplatte	Plaque de réglage d'air	11852201
	Luftregleringsplåt ST133 - ST146	Air regulation plate	Lufteinstellplatte	Plaque de réglage d'air	11867401
	Luftspjäll ST97 - ST120	Air damper	Luftklappe	Volet d'air	11851001
	Luftspjäll ST133 - ST146	Air damper	Luftklappe	Volet d'air	11867501
	Täckplåt, luftreglering ST97 - ST120	Cover plate, air regulation	Deckplatte, Lufteinstellung	Plaque de recouvrement, réglage d'air	11887001
	Täckplåt, luftreglering ST133 - ST146	Cover plate, air regulation	Deckplatte, Lufteinstellung	Plaque de recouvrement, réglage d'air	11887401
	Bussning	Bushing	Buchse	Douille	11847901

	Skala, luftreglering	Scale air regulation	Skala, Lufteinstellung	Echelle, réglage d'air	11887801
	Ställskruv, luftreglering	Adjustment screw, air regulation	Stellschraube, Lufteinstellung	Vis de réglage, réglage d'air	11848501
	Täcklock	Cover plate	Deckplatte	Plaque de recouvrement	11850001
	Skruv	Screw	Schraube	Vis	11750702
	Fläkthusdel, bakre ST97 - 120 röd	Fan housing, rear part red	Brennergehäuse, hinterer Teil rot	Carter du rotor, partie arrière rouge	1206300127
	Fläkthusdel, främre ST120 röd omålad KA	Fan housing, front part red non-lacquered KA	Brennergehäuse, vorderer Teil rot nicht lackiert KA	Carter du rotor, partie frontale rouge non-lacqué KA	1184950227 11849502 1188840227
	Fläkthusdel, Främre ST97 - 108 röd omålad	Fan housing, front part red non-lacquered	Brennergehäuse, vorderer Teil rot nicht lackiert	Carter du rotor, partie frontale rouge non-lacqué	1185690227 11856902

	Fläkthusdel bakre, Röd Omålad	Fan housing rear part, Red Non-lacquered	Brennergehäuse hinterer Teil, Rot Nicht lackiert	Carter du rotor partie arrière' Rouge Non-lacqué	1207200127 12072001
	ST133 - 146				
	Fläkthusdel främre, Röd Omålad	Fan housing front part, Red Non-lacquered	Brennergehäuse vorderer Teil, Rot Nicht lackiert	Carter du rotor partie frontale, Rouge Non-lacqué	1186310227 11863102
	ST133 - 146				
	Avskärningsvägg, fläkthus ST 120 ST97 - 108	Shielding arrangement, fan housing	Abschirmung, Brennergehäuse	Ecran de partition, carter du rotor	11849601 11860801
	Avskärningsvägg, fläkthus ST133 - 146	Shielding arrangement, fan housing	Abschirmung, Brennergehäuse	Ecran de partition, carter du rotor	11863201
	Oljeslang komp. med nipplar L=900	Flexible pipe complete with nipple L=900	Ölschlauch komplett mit Nipple L=900	Flexible complet avec raccord L=900	01760010
	Oljeslang L=900	Flexible pipe L=900	Ölschlauch L=900	Flexible L=900	12110014
	Nippel G1/4x1/4	nipple G1/4x1/4	Nipple G1/4x1/4	raccord G1/4x1/4	11757401
	Nippel G1/4xR3/8	nipple G1/4xR3/8	Nipple G1/4xR3/8	raccord G1/4xR3/8	11246002
	Nippel G1/4xR1/2 Kopparpackning	nipple G1/4xR1/2 Copper gasket	Nipple G1/4xR1/2 Kupferdichtung	raccord G1/4xR1/2 Joint en cuivre	11246003 11021210
	Oljeslang komp. med nippel L=900	Flexible pipe complete with nipple L=900	Ölschlauch komplett mit Nipple L=900	Flexible complet avec raccord L=900	01760026
	Oljeslang L=900	Flexible pipe L=900	Ölschlauch L=900	Flexible L=900	12110014
	nippel G1/4xR1/4 L=900	nipple G1/4xR1/4 L=900	Nipple G1/4xR1/4 L=900	raccord G1/4xR1/4 L=900	11246001

