

TOSHIBA

FILE NO. A05-011

SERVICE MANUAL

AIR-CONDITIONER

SPLIT TYPE

RAS-B10GKVP-E, RAS-B13GKVP-E, RAS-B16GKVP-E
RAS-4M27GAV-E

RAS-M10GKCVP-E, RAS-M13GKCVP-E, RAS-M16GKCVP-E
RAS-4M27GACV-E

RAS-B10GKVP-E, RAS-B13GKVP-E, RAS-B16GKVP-E
RAS-3M26GAV-E

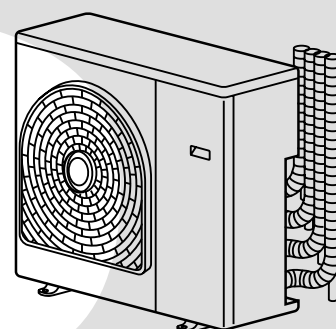
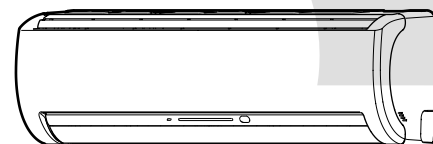

PRINTED IN JAPAN, Dec., 2005 

CONTENTS

1. SAFETY PRECAUTIONS	3
2. SPECIFICATIONS	5
3. REFRIGERANT R410A	24
4. CONSTRUCTION VIEWS	32
5. WIRING DIAGRAM	34
6. SPECIFICATIONS OF ELECTRICAL PARTS	36
7. REFRIGERANT CYCLE DIAGRAM	37
8. CONTROL BLOCK DIAGRAM	45
9. OPERATION DESCRIPTION	48
10. INSTALLATION PROCEDURE	72
11. HOW TO DIAGNOSE THE TROUBLE	87
12. HOW TO REPLACE THE MAIN PARTS	107
13. EXPLODED VIEWS AND PARTS LIST	123

1. SAFETY PRECAUTIONS

For general public use

Power supply cord of outdoor unit shall be more than 1.5 mm² (H07RN-F or 245IEC66) polychloroprene sheathed flexible cord.

- Read this "SAFETY PRECAUTIONS" carefully before servicing.
- The precautions described below include the important items regarding safety. Observe them without fail.
- After the servicing work, perform a trial operation to check for any problem.
- Turn off the main power supply switch (or breaker) before the unit maintenance.

CAUTION

New Refrigerant Air Conditioner Installation

- **THIS AIR CONDITIONER ADOPTS THE NEW HFC REFRIGERANT (R410A) WHICH DOES NOT DESTROY OZONE LAYER.**

R410A refrigerant is apt to be affected by impurities such as water, oxidizing membrane, and oils because the working pressure of R410A refrigerant is approx. 1.6 times of refrigerant R22. Accompanied with the adoption of the new refrigerant, the refrigeration machine oil has also been changed. Therefore, during installation work, be sure that water, dust, former refrigerant, or refrigeration machine oil does not enter into the new type refrigerant R410A air conditioner circuit.

To prevent mixing of refrigerant or refrigerating machine oil, the sizes of connecting sections of charging port on main unit and installation tools are different from those used for the conventional refrigerant units.

Accordingly, special tools are required for the new refrigerant (R410A) units. For connecting pipes, use new and clean piping materials with high pressure fittings made for R410A only, so that water and/or dust does not enter. Moreover, do not use the existing piping because there are some problems with pressure fittings and possible impurities in existing piping.

CAUTION

TO DISCONNECT THE APPLIANCE FROM THE MAIN POWER SUPPLY

This appliance must be connected to the main power supply by a circuit breaker or a switch with a contact separation of at least 3 mm.

The installation fuse (25A D type ) must be used for the power supply line of this air conditioner.

DANGER

- **ASK AN AUTHORIZED DEALER OR QUALIFIED INSTALLATION PROFESSIONAL TO INSTALL/MAINTAIN THE AIR CONDITIONER.**

INAPPROPRIATE SERVICING MAY RESULT IN WATER LEAKAGE, ELECTRIC SHOCK OR FIRE.

- **TURN OFF MAIN POWER SUPPLY BEFORE ATTEMPTING ANY ELECTRICAL WORK. MAKE SURE ALL POWER SWITCHES ARE OFF. FAILURE TO DO SO MAY CAUSE ELECTRIC SHOCK.**



DANGER: HIGH VOLTAGE

The high voltage circuit is incorporated.

Be careful to do the check service, as the electric shock may be caused in case of touching parts on the P.C. board by hand.

- **CORRECTLY CONNECT THE CONNECTING CABLE. IF THE CONNECTING CABLE IS INCORRECTLY CONNECTED, ELECTRIC PARTS MAY BE DAMAGED.**
- **CHECK THAT THE EARTH WIRE IS NOT BROKEN OR DISCONNECTED BEFORE SERVICE AND INSTALLATION. FAILURE TO DO SO MAY CAUSE ELECTRIC SHOCK.**

- DO NOT INSTALL NEAR CONCENTRATIONS OF COMBUSTIBLE GAS OR GAS VAPORS. FAILURE TO FOLLOW THIS INSTRUCTION CAN RESULT IN FIRE OR EXPLOSION.
- TO PREVENT THE INDOOR UNIT FROM OVERHEATING AND CAUSING A FIRE HAZARD, PLACE THE UNIT WELL AWAY (MORE THAN 2 M) FROM HEAT SOURCES SUCH AS RADIATORS, HEAT RESISTORS, FURNACE, STOVES, ETC.
- WHEN MOVING THE AIR-CONDITIONER FOR INSTALLATION IN ANOTHER PLACE, BE VERY CAREFUL NOT TO ALLOW THE SPECIFIED REFRIGERANT (R410A) TO BECOME MIXED WITH ANY OTHER GASEOUS BODY INTO THE REFRIGERATION CIRCUIT. IF AIR OR ANY OTHER GAS IS MIXED IN THE REFRIGERANT, THE GAS PRESSURE IN THE REFRIGERATION CIRCUIT WILL BECOME ABNORMALLY HIGH AND IT MAY RESULT IN THE PIPE BURSTING AND POSSIBLE PERSONNEL INJURIES.
- IN THE EVENT THAT THE REFRIGERANT GAS LEAKS OUT OF THE PIPE DURING THE SERVICE WORK AND THE INSTALLATION WORK, IMMEDIATELY LET FRESH AIR INTO THE ROOM. IF THE REFRIGERANT GAS IS HEATED, SUCH AS BY FIRE, GENERATION OF POISONOUS GAS MAY RESULT.

WARNING

- **Never modify this unit by removing any of the safety guards or bypass any of the safety interlock switches.**
- **Do not install in a place which cannot bear the weight of the unit. Personal injury and property damage can result if the unit falls.**
- **After the installation work, confirm that refrigerant gas does not leak.**
If refrigerant gas leaks into the room and flows near a fire source such as a cooking range, noxious gas may generate.
- **The electrical work must be performed by a qualified electrician in accordance with the Installation Manual. Make sure the air conditioner uses an exclusive circuit.**
An insufficient circuit capacity or inappropriate installation may cause fire.
- **When wiring, use the specified cables and connect the terminals securely to prevent external forces applied to the cable from affecting the terminals.**
- **Be sure to provide grounding.**
Do not connect ground wires to gas pipes, water pipes, lightning rods or ground wires for telephone cables.
- **Conform to the regulations of the local electric company when wiring the power supply.**
Inappropriate grounding may cause electric shock.

CAUTION

- Exposure of unit to water or other moisture before installation may result in an electrical short.
Do not store in a wet basement or expose to rain or water.
- Do not install in a place that can increase the vibration of the unit. Do not install in a place that can amplify the noise level of the unit or where noise or discharged air might disturb neighbors.
- To avoid personal injury, be careful when handling parts with sharp edges.
- **Perform the specified installation work to guard against an earthquake.**
If the air conditioner is not installed appropriately, accidents may occur due to the falling unit.

For Reference:

If a heating operation would be continuously performed for a long time under the condition that the outdoor temperature is 0°C or lower, drainage of defrosted water may be difficult due to freezing of the bottom plate, resulting in a trouble of the cabinet or fan.

It is recommended to procure an antifreeze heater locally for a safe installation of the air conditioner.

For details, contact the dealer.

2. SPECIFICATIONS

The indoor and outdoor units that can be used in combination are shown in the tables below.

Table of models that can be connected

Type	Outdoor unit	Indoor unit		
Heat pump	RAS-3M26GAV-E RAS-4M27GAV-E	RAS-B10GKVP-E	RAS-B13GKVP-E	RAS-B16GKVP-E
		RAS-M10GKV-E	RAS-M13GKV-E	RAS-M16GKV-E
		RAS-M10GDV-E	RAS-M13GDV-E	RAS-M16GDV-E
Cooling-only	RAS-4M27GACV-E	RAS-M10GKCV-E	RAS-M13GKCV-E	RAS-M16GKCV-E
		RAS-M10GKCV-E	RAS-M13GKCV-E	RAS-M16GKCV-E
		RAS-M10GDCV-E	RAS-M13GDCV-E	RAS-M16GDCV-E

Table of models that can be used in combination

Type	Outdoor unit	Combinations of indoor unit models that can be connected
Heat pump	RAS-3M26GAV-E	Refer to page 17 to 22
	RAS-4M27GAV-E	Refer to page 8 to 13
Cooling-only	RAS-3M26GACV-E	Refer to page 14 to 16

NOTES

A 1-room connection is not an option for the indoor units (you cannot connect only one indoor unit).
Be sure to connect indoor units in two rooms or more.

The contents noted in this service manual limit the indoor units to the RAS-B10GKVP-E, RAS-B13GKVP-E, RAS-B16GKVP-E, RAS-M10GKCV-E, RAS-M13GKCV-E and RAS-M16GKCV-E.

For other indoor units that can also be used in combination, see the service manual of each indoor unit.

Indoor unit		File No.
RAS-M10GDV-E	RAS-M10GDCV-E	A05-010
RAS-M13GDV-E	RAS-M13GDCV-E	
RAS-M16GDV-E	RAS-M16GDCV-E	
RAS-M10GKV-E	RAS-M10GKCV-E	TBA
RAS-M13GKV-E	RAS-M13GKCV-E	
RAS-M16GKV-E	RAS-M16GKCV-E	

2-1. Specifications

<Heat Pump Models>

RAS-B10GKVP-E, RAS-B13GKVP-E, RAS-B16GKVP-E / RAS-4M27GAV-E, RAS-3M26GAV-E

Unit model		RAS-B10GKVP-E, RAS-B13GKVP-E, RAS-B16GKVP-E				
		RAS-4M27GAV-E		RAS-3M26GAV-E		
Cooling capacity	(kW)	8.0		7.5		
Cooling capacity range	(kW)	1.4 – 9.2		1.4 – 8.9		
Heating capacity	(kW)	9.0		9.0		
Heating capacity range	(kW)	0.8 – 11.0		0.8 – 10.8		
Power supply		220–240 V, 1 Ph, 50Hz / 220 V, 1 Ph, 60Hz				
Electric characteristics	Indoor	Unit model	RAS-B10GKVP-E	RAS-B13GKVP-E	RAS-B16GKVP-E	
		Running current (A)	0.15	0.15	0.15	
		Power consumption (W)	30	30	30	
		Power factor (%)	91/87/83	91/87/83	91/87/83	
	Outdoor	Unit model	RAS-4M27GAV-E		RAS-3M26GAV-E	
		Operation mode	Cooling	Heating	Cooling	Heating
		Running current (A)	11.60/11.09/10.63	10.44/9.98/9.57	10.44/9.98/9.57	11.83/11.31/10.84
		Power consumption (W)	2500	2250	2250	2550
		Power factor (%)	98	98	98	98
		Starting current (A)	11.60/11.09/10.63		11.83/11.31/10.84	
COP (Cooling/Heating)		3.20/4.00		3.33/3.53		
Operating noise	Indoor (Cooling/Heating)	Unit model	RAS-B10GKVP-E	RAS-B13GKVP-E	RAS-B16GKVP-E	
		High (dB•A)	42/43	43/44	45/45	
		Medium (dB•A)	33/34	34/35	36/36	
	Outdoor (Cooling/Heating)	Unit model	RAS-4M27GAV-E		RAS-3M26GAV-E	
		Full indoor units operating (dB•A)	48/48		48/48	
Indoor unit	Unit model	RAS-B10GKVP-E	RAS-B13GKVP-E	RAS-B16GKVP-E		
	Dimension	Height (mm)	250	250	250	
		Width (mm)	790	790	790	
		Depth (mm)	215	215	215	
	Net weight (kg)	9	9	9		
	Fan motor output (W)	30	30	30		
Air flow rate (Cooling/Heating) (m³/h)	550/610	560/640	640/660			
Outdoor unit	Unit model	RAS-4M27GAV-E		RAS-3M26GAV-E		
	Dimension	Height (mm)	795	795		
		Width (mm)	900	900		
		Depth (mm)	320	320		
	Net weight (kg)	65	64			
	Compressor	Motor output (W)	2000			
		Type	Twin rotary type with DC-inverter variable speed control			
		Model	DA220A2F-20L			
Fan motor output (W)	60					
Air flow rate (m³/h)	High : 3000, Medium : 2800					
Type	Flare connection					
Piping connection	Indoor unit	Unit model	RAS-B10GKVP-E	RAS-B13GKVP-E	RAS-B16GKVP-E	
		Liquid side/Gas side	Ø6.35/ Ø9.52	Ø6.35/ Ø9.52	Ø6.35/ Ø12.7	
	Outdoor unit	Unit model	RAS-4M27GAV-E		RAS-3M26GAV-E	
		A unit liquid side/Gas side	Ø6.35/ Ø12.7		Ø6.35/ Ø12.7	
		B unit liquid side/Gas side	Ø6.35/ Ø9.52		Ø6.35/ Ø9.52	
		C unit liquid side/Gas side	Ø6.35/ Ø9.52		Ø6.35/ Ø9.52	
	D unit liquid side/Gas side	Ø6.35/ Ø9.52		—		
	Maximum length (per unit) (m)	25			25	
	Maximum length (total) (m)	70			50	
	Maximum chargeless length (m)	70			50	
Maximum height difference (m)	15			15		
Name of refrigerant	R410A					
Weight (kg)	2.4					
Wiring connection	Power supply	3 Wires : includes earth				
	Interconnection	4 Wires : includes earth				
Usable temperature range	Indoor (Cooling/Heating) (°C)	21 to 32/0 to 28				
	Outdoor (Cooling/Heating) (°C)	10 to 43/–5 to 24				
Accessory	Indoor unit	Unit model	RAS-B10GKVP-E	RAS-B13GKVP-E	RAS-B16GKVP-E	
		Installation plate	1	1	1	
		Wireless remote controller	1	1	1	
		Batteries	2	2	2	
		Remote controller holder	1	1	1	
		Zeolite-plus filter	1	1	1	
		Plasma pure filter	1	1	1	
		Remote controller holder mounting screw	2 (Ø3.1 × 16L)	2 (Ø3.1 × 16L)	2 (Ø3.1 × 16L)	
		Owner's manual	1	1	1	
		Mounting screw	6 (Ø4 × 25L)	6 (Ø4 × 25L)	6 (Ø4 × 25L)	
	Installation manual	1	1	1		
	Outdoor unit	Unit model	RAS-4M27GAV-E		RAS-3M26GAV-E	
		Installation manual	1		1	
		Specifications	1		1	

- For performance when each indoor unit is combined with other unit, refer to the separate table.
- The specifications may be subject to change without notice for purpose of improvement.

<Cooling Only Models>

RAS-M10GKCV-E, RAS-M13GKCV-E, RAS-M16GKCV-E / RAS-4M27GACV-E

Unit model	Indoor	RAS-M10GKCV-E, RAS-M13GKCV-E, RAS-M16GKCV-E				
	Outdoor	RAS-4M27GACV-E				
Cooling capacity	(kW)	8.0				
Cooling capacity range	(kW)	1.4 – 9.2				
Heating capacity	(kW)	—				
Heating capacity range	(kW)	—				
Power supply		220–240 V, 1 Ph, 50Hz / 220 V, 1 Ph, 60Hz				
Electric characteristics	Indoor	Unit model	RAS-M10GKCV-E	RAS-M13GKCV-E	RAS-M16GKCV-E	
		Running current (A)	0.15	0.15	0.15	
		Power consumption (W)	30	30	30	
		Power factor (%)	91/87/83	91/87/83	91/87/83	
	Outdoor	Unit model	RAS-4M27GACV-E			
		Running current (A)	11.60/11.09/10.63			
		Power consumption (W)	2500			
		Power factor (%)	98			
		Starting current (A)	11.60/11.09/10.63			
COP			3.20			
Operating noise	Indoor	Unit model	RAS-M10GKCV-E	RAS-M13GKCV-E	RAS-M16GKCV-E	
		High (dB•A)	42	43	45	
		Medium (dB•A)	33	34	36	
	Outdoor	Unit model	RAS-4M27GACV-E			
		Full indoor units operating (dB•A)	48			
Indoor unit	Unit model	RAS-M10GKCV-E	RAS-M13GKCV-E	RAS-M16GKCV-E		
	Dimension	Height (mm)	250	250	250	
		Width (mm)	790	790	790	
		Depth (mm)	215	215	215	
	Net weight (kg)	9	9	9		
	Fan motor output (W)	30	30	30		
	Air flow rate (m ³ /h)	550	560	640		
Outdoor unit	Unit model	RAS-4M27GACV-E				
	Dimension	Height (mm)	795			
		Width (mm)	900			
		Depth (mm)	320			
	Net weight (kg)	63				
	Compressor	Motor output (W)	2000			
		Type	Twin rotary type with DC-inverter variable speed control			
		Model	DA220A2F-20L			
	Fan motor output (W)	60				
Air flow rate (m ³ /h)	High : 3000, Medium : 2800					
Type	Flare connection					
Piping connection	Indoor unit	Unit model	RAS-M10GKCV-E	RAS-M13GKCV-E	RAS-M16GKCV-E	
		Liquid side/Gas side	Ø6.35/ Ø9.52	Ø6.35/ Ø9.52	Ø6.35/ Ø12.7	
	Outdoor unit	Unit model	RAS-4M27GACV-E			
		A unit liquid side/Gas side	Ø6.35/ Ø12.7			
		B unit liquid side/Gas side	Ø6.35/ Ø9.52			
		C unit liquid side/Gas side	Ø6.35/ Ø9.52			
		D unit liquid side/Gas side	Ø6.35/ Ø9.52			
	Maximum length (per unit) (m)	25				
	Maximum length (total) (m)	70				
	Maximum chargeless length (m)	70				
Maximum height difference (m)	15					
Name of refrigerant	R410A					
Weight (kg)	2.2					
Wiring connection	Power supply	3 Wires : includes earth				
	Interconnection	4 Wires : includes earth				
Usable temperature range	Indoor (°C)	21 to 32				
	Outdoor (°C)	10 to 43				
Accessory	Indoor unit	Unit model	RAS-M10GKCV-E	RAS-M13GKCV-E	RAS-M16GKCV-E	
		Installation plate	1	1	1	
		Wireless remote controller	1	1	1	
		Batteries	2	2	2	
		Remote controller holder	1	1	1	
		Zeolite-plus filter	1	1	1	
		Plasma pure filter	1	1	1	
		Remote controller holder mounting screw	2 (Ø3.1 x 16L)	2 (Ø3.1 x 16L)	2 (Ø3.1 x 16L)	
		Owner's manual	1	1	1	
		Mounting screw	6 (Ø4 x 25L)	6 (Ø4 x 25L)	6 (Ø4 x 25L)	
	Installation manual	1	1	1		
	Outdoor unit	Unit model	RAS-4M27GACV-E			
		Installation manual	1			
		Specifications	1			

- For performance when each indoor unit is combined with other unit, refer to the separate table.
- The specifications may be subject to change without notice for purpose of improvement.

2-2. Specifications of Performance When Each Indoor Unit is Combined with Other Unit

Outdoor Unit : RAS-4M27GAV-E

<Cooling/220V>

Power supply (V)	Operating status	Indoor unit				Unit capacity (kW)				Cooling capacity (kW)	Power consumption (W)	Operating current (A)	Outdoor noise (dB)
		A	B	C	D	A	B	C	D				
220	1 unit	10	-	-	-	2.7	-	-	-	2.7 (1.4 to 3.2)	750 (640 to 950)	3.87 (3.68 to 4.64)	48
		13	-	-	-	3.7	-	-	-	3.7 (1.4 to 4.4)	1200 (640 to 1520)	5.74 (3.68 to 7.20)	48
		16	-	-	-	4.5	-	-	-	4.5 (1.4 to 5.0)	1650 (640 to 2000)	7.81 (3.68 to 9.28)	48
	2 units	10	10	-	-	2.70	2.70	-	-	5.4 (2.5 to 6.3)	1530 (640 to 2040)	7.10 (3.64 to 9.46)	48
		13	10	-	-	3.41	2.49	-	-	5.9 (2.7 to 6.6)	1810 (660 to 2220)	8.40 (3.75 to 10.30)	48
		16	10	-	-	3.94	2.36	-	-	6.3 (2.9 to 6.9)	2040 (670 to 2400)	9.46 (3.81 to 11.13)	48
		13	13	-	-	3.15	3.15	-	-	6.3 (2.9 to 6.9)	2040 (670 to 2400)	9.46 (3.81 to 11.13)	48
		16	13	-	-	3.73	3.07	-	-	6.8 (3.0 to 7.2)	2320 (690 to 2570)	10.76 (3.92 to 11.92)	48
		16	16	-	-	3.60	3.60	-	-	7.2 (3.2 to 7.5)	2550 (700 to 2750)	11.83 (3.98 to 12.76)	48
	3 units	10	10	10	-	2.53	2.53	2.53	-	7.6 (3.8 to 8.2)	2400 (950 to 2720)	11.13 (4.80 to 12.62)	48
		13	10	10	-	3.13	2.28	2.28	-	7.7 (3.9 to 8.3)	2410 (960 to 2740)	11.18 (4.85 to 12.71)	48
		16	10	10	-	3.50	2.10	2.10	-	7.7 (4.0 to 8.5)	2410 (960 to 2790)	11.18 (4.85 to 12.94)	48
		13	13	10	-	2.82	2.82	2.06	-	7.7 (4.0 to 8.5)	2410 (960 to 2790)	11.18 (4.85 to 12.94)	48
		16	13	10	-	3.22	2.65	1.93	-	7.8 (4.1 to 8.6)	2430 (970 to 2810)	11.27 (4.90 to 13.03)	48
		13	13	13	-	2.60	2.60	2.60	-	7.8 (4.1 to 8.6)	2430 (970 to 2810)	11.27 (4.90 to 13.03)	48
		16	16	10	-	3.04	3.04	1.82	-	7.9 (4.1 to 8.7)	2440 (970 to 2830)	11.32 (4.90 to 13.13)	48
		16	13	13	-	2.99	2.46	2.46	-	7.9 (4.1 to 8.7)	2440 (970 to 2830)	11.32 (4.90 to 13.13)	48
		16	16	13	-	2.80	2.80	2.30	-	7.9 (4.2 to 8.9)	2440 (970 to 2880)	11.32 (4.90 to 13.36)	48
		16	16	16	-	2.67	2.67	2.67	-	8.0 (4.3 to 9.0)	2450 (980 to 2900)	11.36 (4.95 to 13.45)	48
	4 units	10	10	10	10	1.98	1.98	1.98	1.98	7.9 (4.0 to 8.7)	2450 (930 to 2800)	11.36 (4.70 to 12.99)	48
		13	10	10	10	2.48	1.81	1.81	1.81	7.9 (4.1 to 8.8)	2450 (940 to 2820)	11.36 (4.75 to 13.08)	48
		16	10	10	10	2.86	1.71	1.71	1.71	8.0 (4.1 to 9.0)	2500 (940 to 2860)	11.60 (4.75 to 13.27)	48
		13	13	10	10	2.31	2.31	1.69	1.69	8.0 (4.1 to 9.0)	2500 (940 to 2860)	11.60 (4.75 to 13.27)	48
		16	13	10	10	2.65	2.18	1.59	1.59	8.0 (4.2 to 9.1)	2500 (950 to 2880)	11.60 (4.80 to 13.36)	48
		13	13	13	10	2.14	2.14	2.14	1.57	8.0 (4.2 to 9.1)	2500 (950 to 2880)	11.60 (4.80 to 13.36)	48
		16	13	13	10	2.47	2.03	2.03	1.48	8.0 (4.2 to 9.2)	2500 (950 to 2900)	11.60 (4.80 to 13.45)	48
		13	13	13	13	2.00	2.00	2.00	2.00	8.0 (4.2 to 9.2)	2500 (950 to 2900)	11.60 (4.80 to 13.45)	48
16		16	10	10	2.50	2.50	1.50	1.50	8.0 (4.2 to 9.2)	2500 (950 to 2900)	11.60 (4.80 to 13.45)	48	

- The above specification values are those under the conditions that the indoor DB/WB=27/19°C and the outdoor DB/WB=35/-°C.

Outdoor Unit : RAS-4M27GAV-E

<Cooling/230V>

Power supply (V)	Operating status	Indoor unit				Unit capacity (kW)				Cooling capacity (kW)	Power consumption (W)	Operating current (A)	Outdoor noise (dB)
		A	B	C	D	A	B	C	D				
230	1 unit	10	-	-	-	2.7	-	-	-	2.7 (1.4 to 3.2)	750 (640 to 950)	3.71 (3.52 to 4.44)	48
		13	-	-	-	3.7	-	-	-	3.7 (1.4 to 4.4)	1200 (640 to 1520)	5.49 (3.52 to 6.88)	48
		16	-	-	-	4.5	-	-	-	4.5 (1.4 to 5.0)	1650 (640 to 2000)	7.47 (3.52 to 8.87)	48
	2 units	10	10	-	-	2.70	2.70	-	-	5.4 (2.5 to 6.3)	1530 (640 to 2040)	6.79 (3.48 to 9.05)	48
		13	10	-	-	3.41	2.49	-	-	5.9 (2.7 to 6.6)	1810 (660 to 2220)	8.03 (3.59 to 9.85)	48
		16	10	-	-	3.94	2.36	-	-	6.3 (2.9 to 6.9)	2040 (670 to 2400)	9.05 (3.64 to 10.65)	48
		13	13	-	-	3.15	3.15	-	-	6.3 (2.9 to 6.9)	2040 (670 to 2400)	9.05 (3.64 to 10.65)	48
		16	13	-	-	3.73	3.07	-	-	6.8 (3.0 to 7.2)	2320 (690 to 2570)	10.29 (3.75 to 11.40)	48
		16	16	-	-	3.60	3.60	-	-	7.2 (3.2 to 7.5)	2550 (700 to 2750)	11.31 (3.80 to 12.20)	48
	3 units	10	10	10	-	2.53	2.53	2.53	-	7.6 (3.8 to 8.2)	2400 (950 to 2720)	10.65 (4.59 to 12.07)	48
		13	10	10	-	3.13	2.28	2.28	-	7.7 (3.9 to 8.3)	2410 (960 to 2740)	10.69 (4.64 to 12.16)	48
		16	10	10	-	3.50	2.10	2.10	-	7.7 (4.0 to 8.5)	2410 (960 to 2790)	10.69 (4.64 to 12.38)	48
		13	13	10	-	2.82	2.82	2.06	-	7.7 (4.0 to 8.5)	2410 (960 to 2790)	10.69 (4.64 to 12.38)	48
		16	13	10	-	3.22	2.65	1.93	-	7.8 (4.1 to 8.6)	2430 (970 to 2810)	10.78 (4.69 to 12.47)	48
		13	13	13	-	2.60	2.60	2.60	-	7.8 (4.1 to 8.6)	2430 (970 to 2810)	10.78 (4.69 to 12.47)	48
		16	16	10	-	3.04	3.04	1.82	-	7.9 (4.1 to 8.7)	2440 (970 to 2830)	10.83 (4.69 to 12.56)	48
		16	13	13	-	2.99	2.46	2.46	-	7.9 (4.1 to 8.7)	2440 (970 to 2830)	10.83 (4.69 to 12.56)	48
		16	16	13	-	2.80	2.80	2.30	-	7.9 (4.2 to 8.9)	2440 (970 to 2880)	10.83 (4.69 to 12.78)	48
		16	16	16	-	2.67	2.67	2.67	-	8.0 (4.3 to 9.0)	2450 (980 to 2900)	10.87 (4.73 to 12.87)	48
	4 units	10	10	10	10	1.98	1.98	1.98	1.98	7.9 (4.0 to 8.7)	2450 (930 to 2800)	10.87 (4.49 to 12.42)	48
		13	10	10	10	2.48	1.81	1.81	1.81	7.9 (4.1 to 8.8)	2450 (940 to 2820)	10.87 (4.54 to 12.51)	48
		16	10	10	10	2.86	1.71	1.71	1.71	8.0 (4.1 to 9.0)	2500 (940 to 2860)	11.09 (4.54 to 12.69)	48
		13	13	10	10	2.31	2.31	1.69	1.69	8.0 (4.1 to 9.0)	2500 (940 to 2860)	11.09 (4.54 to 12.69)	48
		16	13	10	10	2.65	2.18	1.59	1.59	8.0 (4.2 to 9.1)	2500 (950 to 2880)	11.09 (4.59 to 12.78)	48
		13	13	13	10	2.14	2.14	2.14	1.57	8.0 (4.2 to 9.1)	2500 (950 to 2880)	11.09 (4.59 to 12.78)	48
		16	13	13	10	2.47	2.03	2.03	1.48	8.0 (4.2 to 9.2)	2500 (950 to 2900)	11.09 (4.59 to 12.87)	48
		13	13	13	13	2.00	2.00	2.00	2.00	8.0 (4.2 to 9.2)	2500 (950 to 2900)	11.09 (4.59 to 12.87)	48
16		16	10	10	2.50	2.50	1.50	1.50	8.0 (4.2 to 9.2)	2500 (950 to 2900)	11.09 (4.59 to 12.87)	48	

• The above specification values are those under the conditions that the indoor DB/WB=27/19°C and the outdoor DB/WB=35/-°C.

Outdoor Unit : RAS-4M27GAV-E

<Cooling/240V>

Power supply (V)	Operating status	Indoor unit				Unit capacity (kW)				Cooling capacity (kW)	Power consumption (W)	Operating current (A)	Outdoor noise (dB)
		A	B	C	D	A	B	C	D				
240	1 unit	10	-	-	-	2.7	-	-	-	2.7 (1.4 to 3.2)	750 (640 to 950)	3.55 (3.38 to 4.26)	48
		13	-	-	-	3.7	-	-	-	3.7 (1.4 to 4.4)	1200 (640 to 1520)	5.26 (3.38 to 6.60)	48
		16	-	-	-	4.5	-	-	-	4.5 (1.4 to 5.0)	1650 (640 to 2000)	7.16 (3.38 to 8.50)	48
	2 units	10	10	-	-	2.70	2.70	-	-	5.4 (2.5 to 6.3)	1530 (640 to 2040)	6.51 (3.33 to 8.67)	48
		13	10	-	-	3.41	2.49	-	-	5.9 (2.7 to 6.6)	1810 (660 to 2220)	7.70 (3.44 to 9.44)	48
		16	10	-	-	3.94	2.36	-	-	6.3 (2.9 to 6.9)	2040 (670 to 2400)	8.67 (3.49 to 10.20)	48
		13	13	-	-	3.15	3.15	-	-	6.3 (2.9 to 6.9)	2040 (670 to 2400)	8.67 (3.49 to 10.20)	48
		16	13	-	-	3.73	3.07	-	-	6.8 (3.0 to 7.2)	2320 (690 to 2570)	9.86 (3.59 to 10.93)	48
		16	16	-	-	3.60	3.60	-	-	7.2 (3.2 to 7.5)	2550 (700 to 2750)	10.84 (3.65 to 11.69)	48
	3 units	10	10	10	-	2.53	2.53	2.53	-	7.6 (3.8 to 8.2)	2400 (950 to 2720)	10.20 (4.40 to 11.56)	48
		13	10	10	-	3.13	2.28	2.28	-	7.7 (3.9 to 8.3)	2410 (960 to 2740)	10.25 (4.44 to 11.65)	48
		16	10	10	-	3.50	2.10	2.10	-	7.7 (4.0 to 8.5)	2410 (960 to 2790)	10.25 (4.44 to 11.86)	48
		13	13	10	-	2.82	2.82	2.06	-	7.7 (4.0 to 8.5)	2410 (960 to 2790)	10.25 (4.44 to 11.86)	48
		16	13	10	-	3.22	2.65	1.93	-	7.8 (4.1 to 8.6)	2430 (970 to 2810)	10.33 (4.49 to 11.95)	48
		13	13	13	-	2.60	2.60	2.60	-	7.8 (4.1 to 8.6)	2430 (970 to 2810)	10.33 (4.49 to 11.95)	48
		16	16	10	-	3.04	3.04	1.82	-	7.9 (4.1 to 8.7)	2440 (970 to 2830)	10.37 (4.49 to 12.03)	48
		16	13	13	-	2.99	2.46	2.46	-	7.9 (4.1 to 8.7)	2440 (970 to 2830)	10.37 (4.49 to 12.03)	48
		16	16	13	-	2.80	2.80	2.30	-	7.9 (4.2 to 8.9)	2440 (970 to 2880)	10.37 (4.49 to 12.24)	48
		16	16	16	-	2.67	2.67	2.67	-	8.0 (4.3 to 9.0)	2450 (980 to 2900)	10.42 (4.54 to 12.33)	48
	4 units	10	10	10	10	1.98	1.98	1.98	1.98	7.9 (4.0 to 8.7)	2450 (930 to 2800)	10.42 (4.31 to 11.90)	48
		13	10	10	10	2.48	1.81	1.81	1.81	7.9 (4.1 to 8.8)	2450 (940 to 2820)	10.42 (4.35 to 11.99)	48
		16	10	10	10	2.86	1.71	1.71	1.71	8.0 (4.1 to 9.0)	2500 (940 to 2860)	10.63 (4.35 to 12.16)	48
		13	13	10	10	2.31	2.31	1.69	1.69	8.0 (4.1 to 9.0)	2500 (940 to 2860)	10.63 (4.35 to 12.16)	48
		16	13	10	10	2.65	2.18	1.59	1.59	8.0 (4.2 to 9.1)	2500 (950 to 2880)	10.63 (4.40 to 12.24)	48
13		13	13	10	2.14	2.14	2.14	1.57	8.0 (4.2 to 9.1)	2500 (950 to 2880)	10.63 (4.40 to 12.24)	48	
16		13	13	10	2.47	2.03	2.03	1.48	8.0 (4.2 to 9.2)	2500 (950 to 2900)	10.63 (4.40 to 12.33)	48	
13		13	13	13	2.00	2.00	2.00	2.00	8.0 (4.2 to 9.2)	2500 (950 to 2900)	10.63 (4.40 to 12.33)	48	
16		16	10	10	2.50	2.50	1.50	1.50	8.0 (4.2 to 9.2)	2500 (950 to 2900)	10.63 (4.40 to 12.33)	48	

• The above specification values are those under the conditions that the indoor DB/WB=27/19°C and the outdoor DB/WB=35/-°C.

Outdoor Unit : RAS-4M27GAV-E

<Heating/220V>

Power supply (V)	Operating status	Indoor unit				Unit capacity (kW)				Heating capacity (kW)	Power consumption (W)	Operating current (A)	Outdoor noise (dB)
		A	B	C	D	A	B	C	D				
220	1 unit	10	-	-	-	4.0	-	-	-	4.0 (0.8 to 5.2)	1450 (300 to 1980)	6.73 (1.87 to 9.18)	48
		13	-	-	-	5.0	-	-	-	5.0 (0.8 to 6.5)	2050 (310 to 2750)	9.51 (1.93 to 12.76)	48
		16	-	-	-	5.5	-	-	-	5.5 (0.8 to 6.9)	2400 (310 to 3000)	11.13 (1.93 to 13.91)	48
	2 units	10	10	-	-	3.60	3.60	-	-	7.2 (1.5 to 10.0)	2100 (320 to 3200)	9.74 (1.94 to 14.84)	48
		13	10	-	-	4.22	3.38	-	-	7.6 (1.5 to 10.1)	2320 (320 to 3210)	10.76 (1.94 to 14.89)	48
		16	10	-	-	4.57	3.33	-	-	7.9 (1.5 to 10.1)	2480 (320 to 3230)	11.50 (1.94 to 14.98)	48
		13	13	-	-	3.95	3.95	-	-	7.9 (1.5 to 10.1)	2480 (320 to 3230)	11.50 (1.94 to 14.98)	48
		16	13	-	-	4.35	3.95	-	-	8.3 (1.5 to 10.2)	2700 (320 to 3240)	12.52 (1.94 to 15.03)	48
		16	16	-	-	4.30	4.30	-	-	8.6 (1.5 to 10.2)	2860 (320 to 3250)	13.27 (1.94 to 15.07)	48
	3 units	10	10	10	-	2.87	2.87	2.87	-	8.6 (2.0 to 10.4)	2300 (380 to 2750)	10.67 (2.16 to 12.76)	48
		13	10	10	-	3.35	2.68	2.68	-	8.7 (2.0 to 10.5)	2350 (380 to 2760)	10.90 (2.16 to 12.80)	48
		16	10	10	-	3.54	2.58	2.58	-	8.7 (2.0 to 10.5)	2350 (380 to 2760)	10.90 (2.16 to 12.80)	48
		13	13	10	-	3.11	3.11	2.49	-	8.7 (2.0 to 10.5)	2350 (380 to 2760)	10.90 (2.16 to 12.80)	48
		16	13	10	-	3.34	3.03	2.43	-	8.8 (2.0 to 10.6)	2400 (380 to 2780)	11.13 (2.16 to 12.89)	48
		13	13	13	-	2.93	2.93	2.93	-	8.8 (2.0 to 10.6)	2400 (380 to 2780)	11.13 (2.16 to 12.89)	48
		16	16	10	-	3.26	3.26	2.37	-	8.9 (2.0 to 10.7)	2450 (380 to 2790)	11.36 (2.16 to 12.94)	48
		16	13	13	-	3.16	2.87	2.87	-	8.9 (2.0 to 10.7)	2450 (380 to 2790)	11.36 (2.16 to 12.94)	48
		16	16	13	-	3.06	3.06	2.78	-	8.9 (2.0 to 10.7)	2450 (380 to 2790)	11.36 (2.16 to 12.94)	48
		16	16	16	-	3.00	3.00	3.00	-	9.0 (2.0 to 10.8)	2500 (380 to 2800)	11.60 (2.16 to 12.99)	48
	4 units	10	10	10	10	2.23	2.23	2.23	2.23	8.9 (2.2 to 10.8)	2100 (450 to 2810)	9.74 (2.56 to 13.03)	48
		13	10	10	10	2.62	2.09	2.09	2.09	8.9 (2.2 to 10.9)	2100 (460 to 2830)	9.74 (2.61 to 13.13)	48
16		10	10	10	2.83	2.06	2.06	2.06	9.0 (2.2 to 10.9)	2250 (460 to 2830)	10.44 (2.61 to 13.13)	48	
13		13	10	10	2.50	2.50	2.00	2.00	9.0 (2.2 to 10.9)	2250 (470 to 2830)	10.44 (2.67 to 13.13)	48	
16		13	10	10	2.68	2.43	1.95	1.95	9.0 (2.2 to 11.0)	2250 (480 to 2850)	10.44 (2.73 to 13.22)	48	
13		13	13	10	2.37	2.37	2.37	1.89	9.0 (2.2 to 11.0)	2250 (480 to 2850)	10.44 (2.73 to 13.22)	48	
16		13	13	10	2.54	2.31	2.31	1.85	9.0 (2.2 to 11.0)	2250 (490 to 2850)	10.44 (2.78 to 13.22)	48	
13		13	13	13	2.25	2.25	2.25	2.25	9.0 (2.2 to 11.0)	2250 (490 to 2850)	10.44 (2.78 to 13.22)	48	
16		16	10	10	2.61	2.61	1.89	1.89	9.0 (2.2 to 11.0)	2250 (500 to 2850)	10.44 (2.84 to 13.22)	48	

• The above specification values are those under the conditions that the indoor DB/WB=20/-°C and the outdoor DB/WB=7/6°C.

Outdoor Unit : RAS-4M27GAV-E

<Heating/230V>

Power supply (V)	Operating status	Indoor unit				Unit capacity (kW)				Heating capacity (kW)	Power consumption (W)	Operating current (A)	Outdoor noise (dB)
		A	B	C	D	A	B	C	D				
230	1 unit	10	-	-	-	4.0	-	-	-	4.0 (0.8 to 5.2)	1450 (300 to 1980)	6.43 (1.79 to 8.78)	48
		13	-	-	-	5.0	-	-	-	5.0 (0.8 to 6.5)	2050 (310 to 2750)	9.09 (1.85 to 12.20)	48
		16	-	-	-	5.5	-	-	-	5.5 (0.8 to 6.9)	2400 (310 to 3000)	10.65 (1.85 to 13.31)	48
	2 units	10	10	-	-	3.60	3.60	-	-	7.2 (1.5 to 10.0)	2100 (320 to 3200)	9.32 (1.86 to 14.20)	48
		13	10	-	-	4.22	3.38	-	-	7.6 (1.5 to 10.1)	2320 (320 to 3210)	10.29 (1.86 to 14.24)	48
		16	10	-	-	4.57	3.33	-	-	7.9 (1.5 to 10.1)	2480 (320 to 3230)	11.00 (1.86 to 14.33)	48
		13	13	-	-	3.95	3.95	-	-	7.9 (1.5 to 10.1)	2480 (320 to 3230)	11.00 (1.86 to 14.33)	48
		16	13	-	-	4.35	3.95	-	-	8.3 (1.5 to 10.2)	2700 (320 to 3240)	11.98 (1.86 to 14.37)	48
		16	16	-	-	4.30	4.30	-	-	8.6 (1.5 to 10.2)	2860 (320 to 3250)	12.69 (1.86 to 14.42)	48
	3 units	10	10	10	-	2.87	2.87	2.87	-	8.6 (2.0 to 10.4)	2300 (380 to 2750)	10.20 (2.07 to 12.20)	48
		13	10	10	-	3.35	2.68	2.68	-	8.7 (2.0 to 10.5)	2350 (380 to 2760)	10.43 (2.07 to 12.24)	48
		16	10	10	-	3.54	2.58	2.58	-	8.7 (2.0 to 10.5)	2350 (380 to 2760)	10.43 (2.07 to 12.24)	48
		13	13	10	-	3.11	3.11	2.49	-	8.7 (2.0 to 10.5)	2350 (380 to 2760)	10.43 (2.07 to 12.24)	48
		16	13	10	-	3.34	3.03	2.43	-	8.8 (2.0 to 10.6)	2400 (380 to 2780)	10.65 (2.07 to 12.33)	48
		13	13	13	-	2.93	2.93	2.93	-	8.8 (2.0 to 10.6)	2400 (380 to 2780)	10.65 (2.07 to 12.33)	48
		16	16	10	-	3.26	3.26	2.37	-	8.9 (2.0 to 10.7)	2450 (380 to 2790)	10.87 (2.07 to 12.38)	48
		16	13	13	-	3.16	2.87	2.87	-	8.9 (2.0 to 10.7)	2450 (380 to 2790)	10.87 (2.07 to 12.38)	48
		16	16	13	-	3.06	3.06	2.78	-	8.9 (2.0 to 10.7)	2450 (380 to 2790)	10.87 (2.07 to 12.38)	48
		16	16	16	-	3.00	3.00	3.00	-	9.0 (2.0 to 10.8)	2500 (380 to 2800)	11.09 (2.07 to 12.42)	48
	4 units	10	10	10	10	2.23	2.23	2.23	2.23	8.9 (2.2 to 10.8)	2100 (450 to 2810)	9.32 (2.45 to 12.47)	48
		13	10	10	10	2.62	2.09	2.09	2.09	8.9 (2.2 to 10.9)	2100 (460 to 2830)	9.32 (2.50 to 12.56)	48
16		10	10	10	2.83	2.06	2.06	2.06	9.0 (2.2 to 10.9)	2250 (460 to 2830)	9.98 (2.50 to 12.56)	48	
13		13	10	10	2.50	2.50	2.00	2.00	9.0 (2.2 to 10.9)	2250 (470 to 2830)	9.98 (2.55 to 12.56)	48	
16		13	10	10	2.68	2.43	1.95	1.95	9.0 (2.2 to 11.0)	2250 (480 to 2850)	9.98 (2.61 to 12.64)	48	
13		13	13	10	2.37	2.37	2.37	1.89	9.0 (2.2 to 11.0)	2250 (480 to 2850)	9.98 (2.61 to 12.64)	48	
16		13	13	10	2.54	2.31	2.31	1.85	9.0 (2.2 to 11.0)	2250 (490 to 2850)	9.98 (2.66 to 12.64)	48	
13		13	13	13	2.25	2.25	2.25	2.25	9.0 (2.2 to 11.0)	2250 (490 to 2850)	9.98 (2.66 to 12.64)	48	
16		16	10	10	2.61	2.61	1.89	1.89	9.0 (2.2 to 11.0)	2250 (500 to 2850)	9.98 (2.72 to 12.64)	48	

• The above specification values are those under the conditions that the indoor DB/WB=20/-°C and the outdoor DB/WB=7/6°C.

Outdoor Unit : RAS-4M27GAV-E

<Heating/240V>

Power supply (V)	Operating status	Indoor unit				Unit capacity (kW)				Heating capacity (kW)	Power consumption (W)	Operating current (A)	Outdoor noise (dB)
		A	B	C	D	A	B	C	D				
240	1 unit	10	-	-	-	4.0	-	-	-	4.0 (0.8 to 5.2)	1450 (300 to 1980)	6.16 (1.71 to 8.42)	48
		13	-	-	-	5.0	-	-	-	5.0 (0.8 to 6.5)	2050 (310 to 2750)	8.72 (1.77 to 11.69)	48
		16	-	-	-	5.5	-	-	-	5.5 (0.8 to 6.9)	2400 (310 to 3000)	10.20 (1.77 to 12.76)	48
	2 units	10	10	-	-	3.60	3.60	-	-	7.2 (1.5 to 10.0)	2100 (320 to 3200)	8.93 (1.78 to 13.61)	48
		13	10	-	-	4.22	3.38	-	-	7.6 (1.5 to 10.1)	2320 (320 to 3210)	9.86 (1.78 to 13.65)	48
		16	10	-	-	4.57	3.33	-	-	7.9 (1.5 to 10.1)	2480 (320 to 3230)	10.54 (1.78 to 13.73)	48
		13	13	-	-	3.95	3.95	-	-	7.9 (1.5 to 10.1)	2480 (320 to 3230)	10.54 (1.78 to 13.73)	48
		16	13	-	-	4.35	3.95	-	-	8.3 (1.5 to 10.2)	2700 (320 to 3240)	11.48 (1.78 to 13.78)	48
		16	16	-	-	4.30	4.30	-	-	8.6 (1.5 to 10.2)	2860 (320 to 3250)	12.16 (1.78 to 13.82)	48
	3 units	10	10	10	-	2.87	2.87	2.87	-	8.6 (2.0 to 10.4)	2300 (380 to 2750)	9.78 (1.98 to 11.69)	48
		13	10	10	-	3.35	2.68	2.68	-	8.7 (2.0 to 10.5)	2350 (380 to 2760)	9.99 (1.98 to 11.73)	48
		16	10	10	-	3.54	2.58	2.58	-	8.7 (2.0 to 10.5)	2350 (380 to 2760)	9.99 (1.98 to 11.73)	48
		13	13	10	-	3.11	3.11	2.49	-	8.7 (2.0 to 10.5)	2350 (380 to 2760)	9.99 (1.98 to 11.73)	48
		16	13	10	-	3.34	3.03	2.43	-	8.8 (2.0 to 10.6)	2400 (380 to 2780)	10.20 (1.98 to 11.82)	48
		13	13	13	-	2.93	2.93	2.93	-	8.8 (2.0 to 10.6)	2400 (380 to 2780)	10.20 (1.98 to 11.82)	48
		16	16	10	-	3.26	3.26	2.37	-	8.9 (2.0 to 10.7)	2450 (380 to 2790)	10.42 (1.98 to 11.86)	48
		16	13	13	-	3.16	2.87	2.87	-	8.9 (2.0 to 10.7)	2450 (380 to 2790)	10.42 (1.98 to 11.86)	48
		16	16	13	-	3.06	3.06	2.78	-	8.9 (2.0 to 10.7)	2450 (380 to 2790)	10.42 (1.98 to 11.86)	48
		16	16	16	-	3.00	3.00	3.00	-	9.0 (2.0 to 10.8)	2500 (380 to 2800)	10.63 (1.98 to 11.90)	48
	4 units	10	10	10	10	2.23	2.23	2.23	2.23	8.9 (2.2 to 10.8)	2100 (450 to 2810)	8.93 (2.34 to 11.95)	48
		13	10	10	10	2.62	2.09	2.09	2.09	8.9 (2.2 to 10.9)	2100 (460 to 2830)	8.93 (2.40 to 12.03)	48
		16	10	10	10	2.83	2.06	2.06	2.06	9.0 (2.2 to 10.9)	2250 (460 to 2830)	9.57 (2.40 to 12.03)	48
		13	13	10	10	2.50	2.50	2.00	2.00	9.0 (2.2 to 10.9)	2250 (470 to 2830)	9.57 (2.45 to 12.03)	48
		16	13	10	10	2.68	2.43	1.95	1.95	9.0 (2.2 to 11.0)	2250 (480 to 2850)	9.57 (2.50 to 12.12)	48
13		13	13	10	2.37	2.37	2.37	1.89	9.0 (2.2 to 11.0)	2250 (480 to 2850)	9.57 (2.50 to 12.12)	48	
16		13	13	10	2.54	2.31	2.31	1.85	9.0 (2.2 to 11.0)	2250 (490 to 2850)	9.57 (2.55 to 12.12)	48	
13		13	13	13	2.25	2.25	2.25	2.25	9.0 (2.2 to 11.0)	2250 (490 to 2850)	9.57 (2.55 to 12.12)	48	
16		16	10	10	2.61	2.61	1.89	1.89	9.0 (2.2 to 11.0)	2250 (500 to 2850)	9.57 (2.60 to 12.12)	48	

• The above specification values are those under the conditions that the indoor DB/WB=20/-°C and the outdoor DB/WB=7/6°C.

Outdoor Unit : RAS-4M27GACV-E

<Cooling/220V>

Power supply (V)	Operating status	Indoor unit				Unit capacity (kW)				Cooling capacity (kW)	Power consumption (W)	Operating current (A)	Outdoor noise (dB)
		A	B	C	D	A	B	C	D				
220	1 unit	10	-	-	-	2.7	-	-	-	2.7 (1.4 to 3.2)	750 (640 to 950)	3.87 (3.68 to 4.64)	48
		13	-	-	-	3.7	-	-	-	3.7 (1.4 to 4.4)	1200 (640 to 1520)	5.74 (3.68 to 7.20)	48
		16	-	-	-	4.5	-	-	-	4.5 (1.4 to 5.0)	1650 (640 to 2000)	7.81 (3.68 to 9.28)	48
	2 units	10	10	-	-	2.70	2.70	-	-	5.4 (2.5 to 6.3)	1530 (640 to 2040)	7.10 (3.64 to 9.46)	48
		13	10	-	-	3.41	2.49	-	-	5.9 (2.7 to 6.6)	1810 (660 to 2220)	8.40 (3.75 to 10.30)	48
		16	10	-	-	3.94	2.36	-	-	6.3 (2.9 to 6.9)	2040 (670 to 2400)	9.46 (3.81 to 11.13)	48
		13	13	-	-	3.15	3.15	-	-	6.3 (2.9 to 6.9)	2040 (670 to 2400)	9.46 (3.81 to 11.13)	48
		16	13	-	-	3.73	3.07	-	-	6.8 (3.0 to 7.2)	2320 (690 to 2570)	10.76 (3.92 to 11.92)	48
		16	16	-	-	3.60	3.60	-	-	7.2 (3.2 to 7.5)	2550 (700 to 2750)	11.83 (3.98 to 12.76)	48
	3 units	10	10	10	-	2.53	2.53	2.53	-	7.6 (3.8 to 8.2)	2400 (950 to 2720)	11.13 (4.80 to 12.62)	48
		13	10	10	-	3.13	2.28	2.28	-	7.7 (3.9 to 8.3)	2410 (960 to 2740)	11.18 (4.85 to 12.71)	48
		16	10	10	-	3.50	2.10	2.10	-	7.7 (4.0 to 8.5)	2410 (960 to 2790)	11.18 (4.85 to 12.94)	48
		13	13	10	-	2.82	2.82	2.06	-	7.7 (4.0 to 8.5)	2410 (960 to 2790)	11.18 (4.85 to 12.94)	48
		16	13	10	-	3.22	2.65	1.93	-	7.8 (4.1 to 8.6)	2430 (970 to 2810)	11.27 (4.90 to 13.03)	48
		13	13	13	-	2.60	2.60	2.60	-	7.8 (4.1 to 8.6)	2430 (970 to 2810)	11.27 (4.90 to 13.03)	48
		16	16	10	-	3.04	3.04	1.82	-	7.9 (4.1 to 8.7)	2440 (970 to 2830)	11.32 (4.90 to 13.13)	48
		16	13	13	-	2.99	2.46	2.46	-	7.9 (4.1 to 8.7)	2440 (970 to 2830)	11.32 (4.90 to 13.13)	48
		16	16	13	-	2.80	2.80	2.30	-	7.9 (4.2 to 8.9)	2440 (970 to 2880)	11.32 (4.90 to 13.36)	48
		16	16	16	-	2.67	2.67	2.67	-	8.0 (4.3 to 9.0)	2450 (980 to 2900)	11.36 (4.95 to 13.45)	48
	4 units	10	10	10	10	1.98	1.98	1.98	1.98	7.9 (4.0 to 8.7)	2450 (930 to 2800)	11.36 (4.70 to 12.99)	48
		13	10	10	10	2.48	1.81	1.81	1.81	7.9 (4.1 to 8.8)	2450 (940 to 2820)	11.36 (4.75 to 13.08)	48
16		10	10	10	2.86	1.71	1.71	1.71	8.0 (4.1 to 9.0)	2500 (940 to 2860)	11.60 (4.75 to 13.27)	48	
13		13	10	10	2.31	2.31	1.69	1.69	8.0 (4.1 to 9.0)	2500 (940 to 2860)	11.60 (4.75 to 13.27)	48	
16		13	10	10	2.65	2.18	1.59	1.59	8.0 (4.2 to 9.1)	2500 (950 to 2880)	11.60 (4.80 to 13.36)	48	
13		13	13	10	2.14	2.14	2.14	1.57	8.0 (4.2 to 9.1)	2500 (950 to 2880)	11.60 (4.80 to 13.36)	48	
16		13	13	10	2.47	2.03	2.03	1.48	8.0 (4.2 to 9.2)	2500 (950 to 2900)	11.60 (4.80 to 13.45)	48	
13		13	13	13	2.00	2.00	2.00	2.00	8.0 (4.2 to 9.2)	2500 (950 to 2900)	11.60 (4.80 to 13.45)	48	
16		16	10	10	2.50	2.50	1.50	1.50	8.0 (4.2 to 9.2)	2500 (950 to 2900)	11.60 (4.80 to 13.45)	48	

• The above specification values are those under the conditions that the indoor DB/WB=27/19°C and the outdoor DB/WB=35/-°C.

Outdoor Unit : RAS-4M27GACV-E

<Cooling/230V>

Power supply (V)	Operating status	Indoor unit				Unit capacity (kW)				Cooling capacity (kW)	Power consumption (W)	Operating current (A)	Outdoor noise (dB)
		A	B	C	D	A	B	C	D				
230	1 unit	10	-	-	-	2.7	-	-	-	2.7 (1.4 to 3.2)	750 (640 to 950)	3.71 (3.52 to 4.44)	48
		13	-	-	-	3.7	-	-	-	3.7 (1.4 to 4.4)	1200 (640 to 1520)	5.49 (3.52 to 6.88)	48
		16	-	-	-	4.5	-	-	-	4.5 (1.4 to 5.0)	1650 (640 to 2000)	7.47 (3.52 to 8.87)	48
	2 units	10	10	-	-	2.70	2.70	-	-	5.4 (2.5 to 6.3)	1530 (640 to 2040)	6.79 (3.48 to 9.05)	48
		13	10	-	-	3.41	2.49	-	-	5.9 (2.7 to 6.6)	1810 (660 to 2220)	8.03 (3.59 to 9.85)	48
		16	10	-	-	3.94	2.36	-	-	6.3 (2.9 to 6.9)	2040 (670 to 2400)	9.05 (3.64 to 10.65)	48
		13	13	-	-	3.15	3.15	-	-	6.3 (2.9 to 6.9)	2040 (670 to 2400)	9.05 (3.64 to 10.65)	48
		16	13	-	-	3.73	3.07	-	-	6.8 (3.0 to 7.2)	2320 (690 to 2570)	10.29 (3.75 to 11.40)	48
		16	16	-	-	3.60	3.60	-	-	7.2 (3.2 to 7.5)	2550 (700 to 2750)	11.31 (3.80 to 12.20)	48
	3 units	10	10	10	-	2.53	2.53	2.53	-	7.6 (3.8 to 8.2)	2400 (950 to 2720)	10.65 (4.59 to 12.07)	48
		13	10	10	-	3.13	2.28	2.28	-	7.7 (3.9 to 8.3)	2410 (960 to 2740)	10.69 (4.64 to 12.16)	48
		16	10	10	-	3.50	2.10	2.10	-	7.7 (4.0 to 8.5)	2410 (960 to 2790)	10.69 (4.64 to 12.38)	48
		13	13	10	-	2.82	2.82	2.06	-	7.7 (4.0 to 8.5)	2410 (960 to 2790)	10.69 (4.64 to 12.38)	48
		16	13	10	-	3.22	2.65	1.93	-	7.8 (4.1 to 8.6)	2430 (970 to 2810)	10.78 (4.69 to 12.47)	48
		13	13	13	-	2.60	2.60	2.60	-	7.8 (4.1 to 8.6)	2430 (970 to 2810)	10.78 (4.69 to 12.47)	48
		16	16	10	-	3.04	3.04	1.82	-	7.9 (4.1 to 8.7)	2440 (970 to 2830)	10.83 (4.69 to 12.56)	48
		16	13	13	-	2.99	2.46	2.46	-	7.9 (4.1 to 8.7)	2440 (970 to 2830)	10.83 (4.69 to 12.56)	48
		16	16	13	-	2.80	2.80	2.30	-	7.9 (4.2 to 8.9)	2440 (970 to 2880)	10.83 (4.69 to 12.78)	48
		16	16	16	-	2.67	2.67	2.67	-	8.0 (4.3 to 9.0)	2450 (980 to 2900)	10.87 (4.73 to 12.87)	48
	4 units	10	10	10	10	1.98	1.98	1.98	1.98	7.9 (4.0 to 8.7)	2450 (930 to 2800)	10.87 (4.49 to 12.42)	48
		13	10	10	10	2.48	1.81	1.81	1.81	7.9 (4.1 to 8.8)	2450 (940 to 2820)	10.87 (4.54 to 12.51)	48
		16	10	10	10	2.86	1.71	1.71	1.71	8.0 (4.1 to 9.0)	2500 (940 to 2860)	11.09 (4.54 to 12.69)	48
		13	13	10	10	2.31	2.31	1.69	1.69	8.0 (4.1 to 9.0)	2500 (940 to 2860)	11.09 (4.54 to 12.69)	48
		16	13	10	10	2.65	2.18	1.59	1.59	8.0 (4.2 to 9.1)	2500 (950 to 2880)	11.09 (4.59 to 12.78)	48
13		13	13	10	2.14	2.14	2.14	1.57	8.0 (4.2 to 9.1)	2500 (950 to 2880)	11.09 (4.59 to 12.78)	48	
16		13	13	10	2.47	2.03	2.03	1.48	8.0 (4.2 to 9.2)	2500 (950 to 2900)	11.09 (4.59 to 12.87)	48	
13		13	13	13	2.00	2.00	2.00	2.00	8.0 (4.2 to 9.2)	2500 (950 to 2900)	11.09 (4.59 to 12.87)	48	
16		16	10	10	2.50	2.50	1.50	1.50	8.0 (4.2 to 9.2)	2500 (950 to 2900)	11.09 (4.59 to 12.87)	48	

• The above specification values are those under the conditions that the indoor DB/WB=27/19°C and the outdoor DB/WB=35/-°C.

Outdoor Unit : RAS-4M27GACV-E

<Cooling/240V>

Power supply (V)	Operating status	Indoor unit				Unit capacity (kW)				Cooling capacity (kW)	Power consumption (W)	Operating current (A)	Outdoor noise (dB)
		A	B	C	D	A	B	C	D				
240	1 unit	10	-	-	-	2.7	-	-	-	2.7 (1.4 to 3.2)	750 (640 to 950)	3.55 (3.38 to 4.26)	48
		13	-	-	-	3.7	-	-	-	3.7 (1.4 to 4.4)	1200 (640 to 1520)	5.26 (3.38 to 6.60)	48
		16	-	-	-	4.5	-	-	-	4.5 (1.4 to 5.0)	1650 (640 to 2000)	7.16 (3.38 to 8.50)	48
	2 units	10	10	-	-	2.70	2.70	-	-	5.4 (2.5 to 6.3)	1530 (640 to 2040)	6.51 (3.33 to 8.67)	48
		13	10	-	-	3.41	2.49	-	-	5.9 (2.7 to 6.6)	1810 (660 to 2220)	7.70 (3.44 to 9.44)	48
		16	10	-	-	3.94	2.36	-	-	6.3 (2.9 to 6.9)	2040 (670 to 2400)	8.67 (3.49 to 10.20)	48
		13	13	-	-	3.15	3.15	-	-	6.3 (2.9 to 6.9)	2040 (670 to 2400)	8.67 (3.49 to 10.20)	48
		16	13	-	-	3.73	3.07	-	-	6.8 (3.0 to 7.2)	2320 (690 to 2570)	9.86 (3.59 to 10.93)	48
		16	16	-	-	3.60	3.60	-	-	7.2 (3.2 to 7.5)	2550 (700 to 2750)	10.84 (3.65 to 11.69)	48
	3 units	10	10	10	-	2.53	2.53	2.53	-	7.6 (3.8 to 8.2)	2400 (950 to 2720)	10.20 (4.40 to 11.56)	48
		13	10	10	-	3.13	2.28	2.28	-	7.7 (3.9 to 8.3)	2410 (960 to 2740)	10.25 (4.44 to 11.65)	48
		16	10	10	-	3.50	2.10	2.10	-	7.7 (4.0 to 8.5)	2410 (960 to 2790)	10.25 (4.44 to 11.86)	48
		13	13	10	-	2.82	2.82	2.06	-	7.7 (4.0 to 8.5)	2410 (960 to 2790)	10.25 (4.44 to 11.86)	48
		16	13	10	-	3.22	2.65	1.93	-	7.8 (4.1 to 8.6)	2430 (970 to 2810)	10.33 (4.49 to 11.95)	48
		13	13	13	-	2.60	2.60	2.60	-	7.8 (4.1 to 8.6)	2430 (970 to 2810)	10.33 (4.49 to 11.95)	48
		16	16	10	-	3.04	3.04	1.82	-	7.9 (4.1 to 8.7)	2440 (970 to 2830)	10.37 (4.49 to 12.03)	48
		16	13	13	-	2.99	2.46	2.46	-	7.9 (4.1 to 8.7)	2440 (970 to 2830)	10.37 (4.49 to 12.03)	48
		16	16	13	-	2.80	2.80	2.30	-	7.9 (4.2 to 8.9)	2440 (970 to 2880)	10.37 (4.49 to 12.24)	48
		16	16	16	-	2.67	2.67	2.67	-	8.0 (4.3 to 9.0)	2450 (980 to 2900)	10.42 (4.54 to 12.33)	48
	4 units	10	10	10	10	1.98	1.98	1.98	1.98	7.9 (4.0 to 8.7)	2450 (930 to 2800)	10.42 (4.31 to 11.90)	48
		13	10	10	10	2.48	1.81	1.81	1.81	7.9 (4.1 to 8.8)	2450 (940 to 2820)	10.42 (4.35 to 11.99)	48
		16	10	10	10	2.86	1.71	1.71	1.71	8.0 (4.1 to 9.0)	2500 (940 to 2860)	10.63 (4.35 to 12.16)	48
		13	13	10	10	2.31	2.31	1.69	1.69	8.0 (4.1 to 9.0)	2500 (940 to 2860)	10.63 (4.35 to 12.16)	48
		16	13	10	10	2.65	2.18	1.59	1.59	8.0 (4.2 to 9.1)	2500 (950 to 2880)	10.63 (4.40 to 12.24)	48
13		13	13	10	2.14	2.14	2.14	1.57	8.0 (4.2 to 9.1)	2500 (950 to 2880)	10.63 (4.40 to 12.24)	48	
16		13	13	10	2.47	2.03	2.03	1.48	8.0 (4.2 to 9.2)	2500 (950 to 2900)	10.63 (4.40 to 12.33)	48	
13		13	13	13	2.00	2.00	2.00	2.00	8.0 (4.2 to 9.2)	2500 (950 to 2900)	10.63 (4.40 to 12.33)	48	
16		16	10	10	2.50	2.50	1.50	1.50	8.0 (4.2 to 9.2)	2500 (950 to 2900)	10.63 (4.40 to 12.33)	48	

• The above specification values are those under the conditions that the indoor DB/WB=27/19°C and the outdoor DB/WB=35/-°C.

Outdoor Unit : RAS-3M26GAV-E

<Cooling/220V>

Power supply (V)	Operating status	Indoor unit			Unit capacity (kW)			Cooling capacity (kW)	Power consumption (W)	Operating current (A)	Outdoor noise (dB)
		A	B	C	A	B	C				
220	1 unit	10	-	-	2.7	-	-	2.7 (1.4 to 3.2)	750 (640 to 950)	3.87 (3.68 to 4.64)	48
		13	-	-	3.7	-	-	3.7 (1.4 to 4.4)	1200 (640 to 1520)	5.74 (3.68 to 7.20)	48
		16	-	-	4.5	-	-	4.5 (1.4 to 5.0)	1650 (640 to 2000)	7.81 (3.68 to 9.28)	48
	2 units	10	10	-	2.70	2.70	-	5.4 (2.5 to 6.3)	1530 (640 to 2040)	7.10 (3.64 to 9.46)	48
		13	10	-	3.41	2.49	-	5.9 (2.7 to 6.6)	1810 (660 to 2220)	8.40 (3.75 to 10.30)	48
		16	10	-	3.94	2.36	-	6.3 (2.9 to 6.9)	2040 (670 to 2400)	9.46 (3.81 to 11.13)	48
		13	13	-	3.15	3.15	-	6.3 (2.9 to 6.9)	2040 (670 to 2400)	9.46 (3.81 to 11.13)	48
		16	13	-	3.73	3.07	-	6.8 (3.0 to 7.2)	2320 (690 to 2570)	10.76 (3.92 to 11.92)	48
		16	16	-	3.60	3.60	-	7.2 (3.2 to 7.5)	2550 (700 to 2750)	11.83 (3.98 to 12.76)	48
	3 units	10	10	10	2.47	2.47	2.47	7.4 (3.8 to 8.2)	2230 (950 to 2720)	10.34 (4.80 to 12.62)	48
		13	10	10	3.01	2.20	2.20	7.4 (3.9 to 8.3)	2230 (950 to 2750)	10.34 (4.80 to 12.76)	48
		16	10	10	3.36	2.02	2.02	7.4 (4.0 to 8.5)	2230 (950 to 2820)	10.34 (4.80 to 13.08)	48
		13	13	10	2.71	2.71	1.98	7.4 (4.0 to 8.5)	2230 (950 to 2820)	10.34 (4.80 to 13.08)	48
		16	13	10	3.10	2.55	1.86	7.5 (4.0 to 8.6)	2250 (980 to 2850)	10.44 (4.95 to 13.22)	48
		13	13	13	2.50	2.50	2.50	7.5 (4.0 to 8.6)	2250 (980 to 2850)	10.44 (4.95 to 13.22)	48
16		16	10	2.88	2.88	1.73	7.5 (4.1 to 8.8)	2250 (980 to 2920)	10.44 (4.95 to 13.54)	48	
16		13	13	2.84	2.33	2.33	7.5 (4.1 to 8.8)	2250 (980 to 2920)	10.44 (4.95 to 13.54)	48	
16		16	13	2.66	2.66	2.19	7.5 (4.2 to 8.9)	2250 (980 to 2950)	10.44 (4.95 to 13.68)	48	

- The above specification values are those under the conditions that the indoor DB/WB=27/19°C and the outdoor DB/WB=35/-°C.

Outdoor Unit : RAS-3M26GAV-E

<Cooling/230V>

Power supply (V)	Operating status	Indoor unit			Unit capacity (kW)			Cooling capacity (kW)	Power consumption (W)	Operating current (A)	Outdoor noise (dB)
		A	B	C	A	B	C				
230	1 unit	10	-	-	2.7	-	-	2.7 (1.4 to 3.2)	750 (640 to 950)	3.71 (3.52 to 4.44)	48
		13	-	-	3.7	-	-	3.7 (1.4 to 4.4)	1200 (640 to 1520)	5.49 (3.52 to 6.88)	48
		16	-	-	4.5	-	-	4.5 (1.4 to 5.0)	1650 (640 to 2000)	7.47 (3.52 to 8.87)	48
	2 units	10	10	-	2.70	2.70	-	5.4 (2.5 to 6.3)	1530 (640 to 2040)	6.79 (3.48 to 9.05)	48
		13	10	-	3.41	2.49	-	5.9 (2.7 to 6.6)	1810 (660 to 2220)	8.03 (3.59 to 9.85)	48
		16	10	-	3.94	2.36	-	6.3 (2.9 to 6.9)	2040 (670 to 2400)	9.05 (3.64 to 10.65)	48
		13	13	-	3.15	3.15	-	6.3 (2.9 to 6.9)	2040 (670 to 2400)	9.05 (3.64 to 10.65)	48
		16	13	-	3.73	3.07	-	6.8 (3.0 to 7.2)	2320 (690 to 2570)	10.29 (3.75 to 11.40)	48
		16	16	-	3.60	3.60	-	7.2 (3.2 to 7.5)	2550 (700 to 2750)	11.31 (3.80 to 12.20)	48
	3 units	10	10	10	2.47	2.47	2.47	7.4 (3.8 to 8.2)	2230 (950 to 2720)	9.89 (4.59 to 12.07)	48
		13	10	10	3.01	2.20	2.20	7.4 (3.9 to 8.3)	2230 (950 to 2750)	9.89 (4.59 to 12.20)	48
		16	10	10	3.36	2.02	2.02	7.4 (4.0 to 8.5)	2230 (950 to 2820)	9.89 (4.59 to 12.51)	48
		13	13	10	2.71	2.71	1.98	7.4 (4.0 to 8.5)	2230 (950 to 2820)	9.89 (4.59 to 12.51)	48
		16	13	10	3.10	2.55	1.86	7.5 (4.0 to 8.6)	2250 (980 to 2850)	9.98 (4.73 to 12.64)	48
		13	13	13	2.50	2.50	2.50	7.5 (4.0 to 8.6)	2250 (980 to 2850)	9.98 (4.73 to 12.64)	48
16		16	10	2.88	2.88	1.73	7.5 (4.1 to 8.8)	2250 (980 to 2920)	9.98 (4.73 to 12.95)	48	
16		13	13	2.84	2.33	2.33	7.5 (4.1 to 8.8)	2250 (980 to 2920)	9.98 (4.73 to 12.95)	48	
16		16	13	2.66	2.66	2.19	7.5 (4.2 to 8.9)	2250 (980 to 2950)	9.98 (4.73 to 13.09)	48	

- The above specification values are those under the conditions that the indoor DB/WB=27/19°C and the outdoor DB/WB=35/-°C.

Outdoor Unit : RAS-3M26GAV-E

<Cooling/240V>

Power supply (V)	Operating status	Indoor unit			Unit capacity (kW)			Cooling capacity (kW)	Power consumption (W)	Operating current (A)	Outdoor noise (dB)
		A	B	C	A	B	C				
240	1 unit	10	-	-	2.7	-	-	2.7 (1.4 to 3.2)	750 (640 to 950)	3.55 (3.38 to 4.26)	48
		13	-	-	3.7	-	-	3.7 (1.4 to 4.4)	1200 (640 to 1520)	5.26 (3.38 to 6.60)	48
		16	-	-	4.5	-	-	4.5 (1.4 to 5.0)	1650 (640 to 2000)	7.16 (3.38 to 8.50)	48
	2 units	10	10	-	2.70	2.70	-	5.4 (2.5 to 6.3)	1530 (640 to 2040)	6.51 (3.33 to 8.67)	48
		13	10	-	3.41	2.49	-	5.9 (2.7 to 6.6)	1810 (660 to 2220)	7.70 (3.44 to 9.44)	48
		16	10	-	3.94	2.36	-	6.3 (2.9 to 6.9)	2040 (670 to 2400)	8.67 (3.49 to 10.20)	48
		13	13	-	3.15	3.15	-	6.3 (2.9 to 6.9)	2040 (670 to 2400)	8.67 (3.49 to 10.20)	48
		16	13	-	3.73	3.07	-	6.8 (3.0 to 7.2)	2320 (690 to 2570)	9.86 (3.59 to 10.93)	48
		16	16	-	3.60	3.60	-	7.2 (3.2 to 7.5)	2550 (700 to 2750)	10.84 (3.65 to 11.69)	48
	3 units	10	10	10	2.47	2.47	2.47	7.4 (3.8 to 8.2)	2230 (950 to 2720)	9.48 (4.40 to 11.56)	48
		13	10	10	3.01	2.20	2.20	7.4 (3.9 to 8.3)	2230 (950 to 2750)	9.48 (4.40 to 11.69)	48
		16	10	10	3.36	2.02	2.02	7.4 (4.0 to 8.5)	2230 (950 to 2820)	9.48 (4.40 to 11.99)	48
		13	13	10	2.71	2.71	1.98	7.4 (4.0 to 8.5)	2230 (950 to 2820)	9.48 (4.40 to 11.99)	48
		16	13	10	3.10	2.55	1.86	7.5 (4.0 to 8.6)	2250 (980 to 2850)	9.57 (4.54 to 12.12)	48
		13	13	13	2.50	2.50	2.50	7.5 (4.0 to 8.6)	2250 (980 to 2850)	9.57 (4.54 to 12.12)	48
16		16	10	2.88	2.88	1.73	7.5 (4.1 to 8.8)	2250 (980 to 2920)	9.57 (4.54 to 12.41)	48	
16		13	13	2.84	2.33	2.33	7.5 (4.1 to 8.8)	2250 (980 to 2920)	9.57 (4.54 to 12.41)	48	
16		16	13	2.66	2.66	2.19	7.5 (4.2 to 8.9)	2250 (980 to 2950)	9.57 (4.54 to 12.54)	48	

- The above specification values are those under the conditions that the indoor DB/WB=27/19°C and the outdoor DB/WB=35/-°C.

Outdoor Unit : RAS-3M26GAV-E

<Heating/220V>

Power supply (V)	Operating status	Indoor unit			Unit capacity (kW)			Heating capacity (kW)	Power consumption (W)	Operating current (A)	Outdoor noise (dB)
		A	B	C	A	B	C				
220	1 unit	10	-	-	4.0	-	-	4.0 (0.8 to 5.2)	1500 (300 to 1980)	6.96 (1.87 to 9.18)	48
		13	-	-	5.0	-	-	5.0 (0.8 to 6.5)	2050 (310 to 2750)	9.51 (1.93 to 12.76)	48
		16	-	-	5.5	-	-	5.5 (0.8 to 6.9)	2400 (310 to 3000)	11.13 (1.93 to 13.91)	48
	2 units	10	10	-	3.60	3.60	-	7.2 (1.5 to 10.0)	2050 (320 to 3200)	9.51 (1.94 to 14.84)	48
		13	10	-	4.22	3.38	-	7.6 (1.5 to 10.1)	2240 (320 to 3210)	10.39 (1.94 to 14.89)	48
		16	10	-	4.57	3.33	-	7.9 (1.5 to 10.1)	2380 (320 to 3230)	11.04 (1.94 to 14.98)	48
		13	13	-	3.95	3.95	-	7.9 (1.5 to 10.1)	2380 (320 to 3230)	11.04 (1.94 to 14.98)	48
		16	13	-	4.35	3.95	-	8.3 (1.5 to 10.2)	2560 (320 to 3240)	11.87 (1.94 to 15.03)	48
		16	16	-	4.30	4.30	-	8.6 (1.5 to 10.2)	2700 (320 to 3250)	12.52 (1.94 to 15.07)	48
	3 units	10	10	10	2.87	2.87	2.87	8.6 (2.0 to 10.4)	2300 (380 to 2750)	10.67 (2.16 to 12.76)	48
		13	10	10	3.35	2.68	2.68	8.7 (2.0 to 10.5)	2360 (380 to 2760)	10.95 (2.16 to 12.80)	48
		16	10	10	3.59	2.61	2.61	8.8 (2.0 to 10.6)	2430 (380 to 2780)	11.27 (2.16 to 12.89)	48
		13	13	10	3.14	3.14	2.51	8.8 (2.0 to 10.6)	2430 (380 to 2780)	11.27 (2.16 to 12.89)	48
		16	13	10	3.34	3.03	2.43	8.8 (2.0 to 10.6)	2430 (380 to 2780)	11.27 (2.16 to 12.89)	48
		13	13	13	2.93	2.93	2.93	8.8 (2.0 to 10.6)	2430 (380 to 2780)	11.27 (2.16 to 12.89)	48
16		16	10	3.26	3.26	2.37	8.9 (2.0 to 10.7)	2490 (380 to 2790)	11.55 (2.16 to 12.94)	48	
16		13	13	3.16	2.87	2.87	8.9 (2.0 to 10.7)	2490 (380 to 2790)	11.55 (2.16 to 12.94)	48	
16		16	13	3.09	3.09	2.81	9.0 (2.0 to 10.8)	2550 (380 to 2800)	11.83 (2.16 to 12.99)	48	

- The above specification values are those under the conditions that the indoor DB/WB=20/-°C and the outdoor DB/WB=7/6°C.

Outdoor Unit : RAS-3M26GAV-E

<Heating/230V>

Power supply (V)	Operating status	Indoor unit			Unit capacity (kW)			Heating capacity (kW)	Power consumption (W)	Operating current (A)	Outdoor noise (dB)
		A	B	C	A	B	C				
230	1 unit	10	-	-	4.0	-	-	4.0 (0.8 to 5.2)	1500 (300 to 1980)	6.65 (1.79 to 8.78)	48
		13	-	-	5.0	-	-	5.0 (0.8 to 6.5)	2050 (310 to 2750)	9.09 (1.85 to 12.20)	48
		16	-	-	5.5	-	-	5.5 (0.8 to 6.9)	2400 (310 to 3000)	10.65 (1.85 to 13.31)	48
	2 units	10	10	-	3.60	3.60	-	7.2 (1.5 to 10.0)	2050 (320 to 3200)	9.09 (1.86 to 14.20)	48
		13	10	-	4.22	3.38	-	7.6 (1.5 to 10.1)	2240 (320 to 3210)	9.94 (1.86 to 14.24)	48
		16	10	-	4.57	3.33	-	7.9 (1.5 to 10.1)	2380 (320 to 3230)	10.56 (1.86 to 14.33)	48
		13	13	-	3.95	3.95	-	7.9 (1.5 to 10.1)	2380 (320 to 3230)	10.56 (1.86 to 14.33)	48
		16	13	-	4.35	3.95	-	8.3 (1.5 to 10.2)	2560 (320 to 3240)	11.36 (1.86 to 14.37)	48
		16	16	-	4.30	4.30	-	8.6 (1.5 to 10.2)	2700 (320 to 3250)	11.98 (1.86 to 14.42)	48
	3 units	10	10	10	2.87	2.87	2.87	8.6 (2.0 to 10.4)	2300 (380 to 2750)	10.20 (2.07 to 12.20)	48
		13	10	10	3.35	2.68	2.68	8.7 (2.0 to 10.5)	2360 (380 to 2760)	10.47 (2.07 to 12.24)	48
		16	10	10	3.59	2.61	2.61	8.8 (2.0 to 10.6)	2430 (380 to 2780)	10.78 (2.07 to 12.33)	48
		13	13	10	3.14	3.14	2.51	8.8 (2.0 to 10.6)	2430 (380 to 2780)	10.78 (2.07 to 12.33)	48
		16	13	10	3.34	3.03	2.43	8.8 (2.0 to 10.6)	2430 (380 to 2780)	10.78 (2.07 to 12.33)	48
		13	13	13	2.93	2.93	2.93	8.8 (2.0 to 10.6)	2430 (380 to 2780)	10.78 (2.07 to 12.33)	48
		16	16	10	3.26	3.26	2.37	8.9 (2.0 to 10.7)	2490 (380 to 2790)	11.05 (2.07 to 12.38)	48
		16	13	13	3.16	2.87	2.87	8.9 (2.0 to 10.7)	2490 (380 to 2790)	11.05 (2.07 to 12.38)	48
		16	16	13	3.09	3.09	2.81	9.0 (2.0 to 10.8)	2550 (380 to 2800)	11.31 (2.07 to 12.42)	48

- The above specification values are those under the conditions that the indoor DB/WB=20/-°C and the outdoor DB/WB=7/6°C.

Outdoor Unit : RAS-3M26GAV-E

<Heating/240V>

Power supply (V)	Operating status	Indoor unit			Unit capacity (kW)			Heating capacity (kW)	Power consumption (W)	Operating current (A)	Outdoor noise (dB)
		A	B	C	A	B	C				
240	1 unit	10	-	-	4.0	-	-	4.0 (0.8 to 5.2)	1500 (300 to 1980)	6.38 (1.71 to 8.42)	48
		13	-	-	5.0	-	-	5.0 (0.8 to 6.5)	2050 (310 to 2750)	8.72 (1.77 to 11.69)	48
		16	-	-	5.5	-	-	5.5 (0.8 to 6.9)	2400 (310 to 3000)	10.20 (1.77 to 12.76)	48
	2 units	10	10	-	3.60	3.60	-	7.2 (1.5 to 10.0)	2050 (320 to 3200)	8.72 (1.78 to 13.61)	48
		13	10	-	4.22	3.38	-	7.6 (1.5 to 10.1)	2240 (320 to 3210)	9.52 (1.78 to 13.65)	48
		16	10	-	4.57	3.33	-	7.9 (1.5 to 10.1)	2380 (320 to 3230)	10.12 (1.78 to 13.73)	48
		13	13	-	3.95	3.95	-	7.9 (1.5 to 10.1)	2380 (320 to 3230)	10.12 (1.78 to 13.73)	48
		16	13	-	4.35	3.95	-	8.3 (1.5 to 10.2)	2560 (320 to 3240)	10.88 (1.78 to 13.78)	48
		16	16	-	4.30	4.30	-	8.6 (1.5 to 10.2)	2700 (320 to 3250)	11.48 (1.78 to 13.82)	48
	3 units	10	10	10	2.87	2.87	2.87	8.6 (2.0 to 10.4)	2300 (380 to 2750)	9.78 (1.98 to 11.69)	48
		13	10	10	3.35	2.68	2.68	8.7 (2.0 to 10.5)	2360 (380 to 2760)	10.03 (1.98 to 11.73)	48
		16	10	10	3.59	2.61	2.61	8.8 (2.0 to 10.6)	2430 (380 to 2780)	10.33 (1.98 to 11.82)	48
		13	13	10	3.14	3.14	2.51	8.8 (2.0 to 10.6)	2430 (380 to 2780)	10.33 (1.98 to 11.82)	48
		16	13	10	3.34	3.03	2.43	8.8 (2.0 to 10.6)	2430 (380 to 2780)	10.33 (1.98 to 11.82)	48
		13	13	13	2.93	2.93	2.93	8.8 (2.0 to 10.6)	2430 (380 to 2780)	10.33 (1.98 to 11.82)	48
16		16	10	3.26	3.26	2.37	8.9 (2.0 to 10.7)	2490 (380 to 2790)	10.59 (1.98 to 11.86)	48	
16		13	13	3.16	2.87	2.87	8.9 (2.0 to 10.7)	2490 (380 to 2790)	10.59 (1.98 to 11.86)	48	
16		16	13	3.09	3.09	2.81	9.0 (2.0 to 10.8)	2550 (380 to 2800)	10.84 (1.98 to 11.90)	48	

- The above specification values are those under the conditions that the indoor DB/WB=20/-°C and the outdoor DB/WB=7/6°C.

2-2-1. Operation Characteristic Curve

<Cooling>

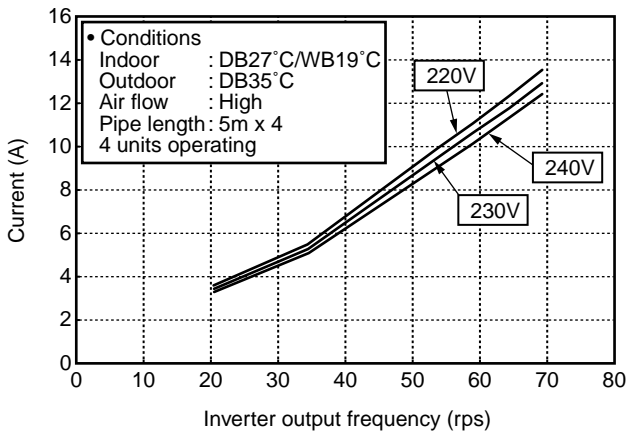

<Heating>

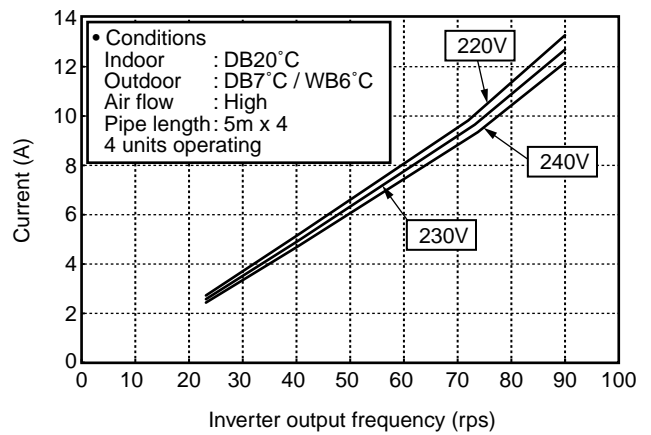

2-2-2. Capacity Variation Ratio According to Outdoor Temperature

<Cooling>

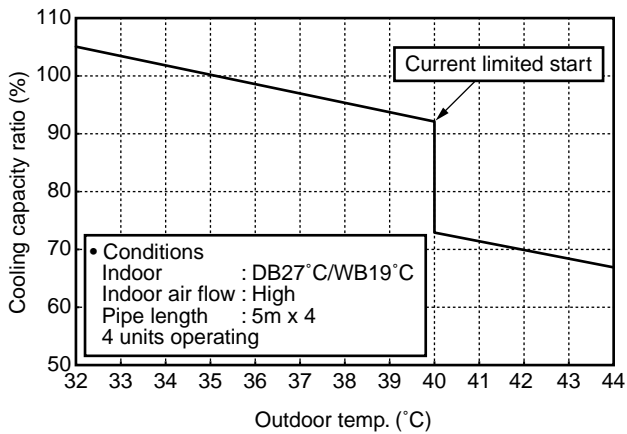

<Heating>

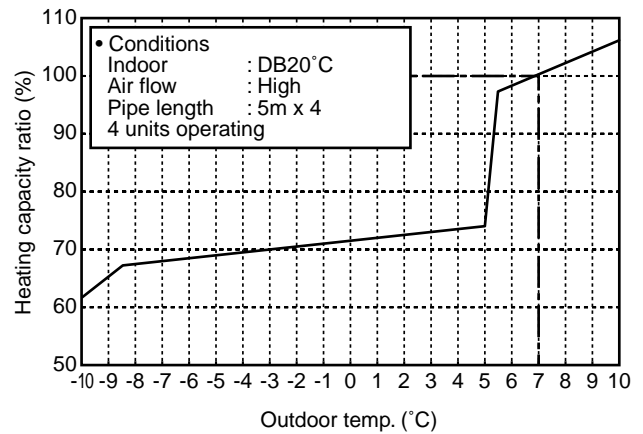

2-2-3. Capacity Variation Ratio According to Pipe Length

<Cooling>

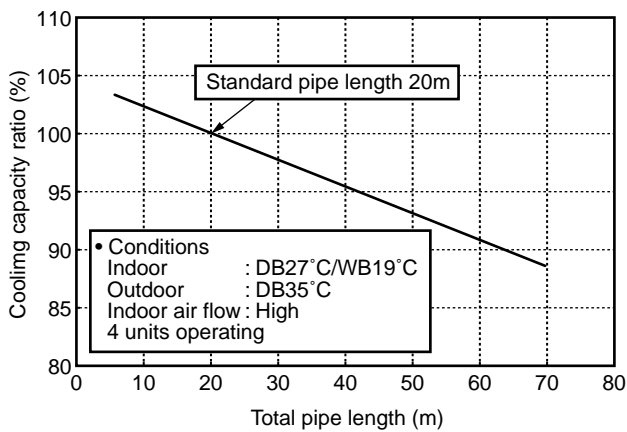

<Heating>

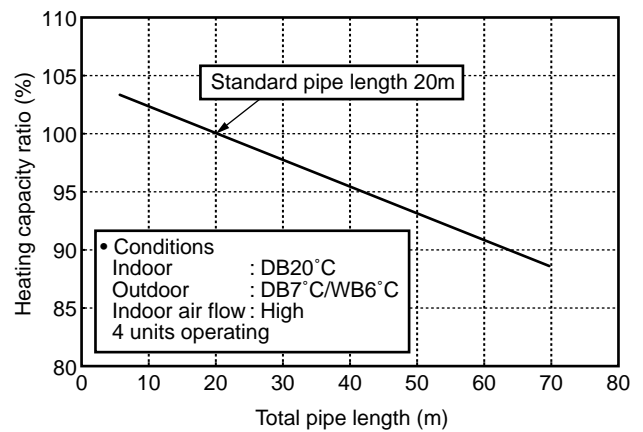

3. REFRIGERANT R410A

This air conditioner adopts the new refrigerant HFC (R410A) which does not damage the ozone layer.

The working pressure of the new refrigerant R410A is 1.6 times higher than conventional refrigerant (R22). The refrigerating oil is also changed in accordance with change of refrigerant, so be careful that water, dust, and existing refrigerant or refrigerating oil are not entered in the refrigerant cycle of the air conditioner using the new refrigerant during installation work or servicing time.

The next section describes the precautions for air conditioner using the new refrigerant. Conforming to contents of the next section together with the general cautions included in this manual, perform the correct and safe work.

3-1. Safety During Installation/Serviceing

As R410A's pressure is about 1.6 times higher than that of R22, improper installation/serviceing may cause a serious trouble. By using tools and materials exclusive for R410A, it is necessary to carry out installation/serviceing safely while taking the following precautions into consideration.

1. Never use refrigerant other than R410A in an air conditioner which is designed to operate with R410A.
If other refrigerant than R410A is mixed, pressure in the refrigeration cycle becomes abnormally high, and it may cause personal injury, etc. by a rupture.
2. Confirm the used refrigerant name, and use tools and materials exclusive for the refrigerant R410A.
The refrigerant name R410A is indicated on the visible place of the outdoor unit of the air conditioner using R410A as refrigerant. To prevent mischarging, the diameter of the service port differs from that of R22.
3. If a refrigeration gas leakage occurs during installation/serviceing, be sure to ventilate fully.
If the refrigerant gas comes into contact with fire, a poisonous gas may occur.
4. When installing or removing an air conditioner, do not allow air or moisture to remain in the refrigeration cycle. Otherwise, pressure in the refrigeration cycle may become abnormally high so that a rupture or personal injury may be caused.
5. After completion of installation work, check to make sure that there is no refrigeration gas leakage.
If the refrigerant gas leaks into the room, coming into contact with fire in the fan-driven heater, space heater, etc., a poisonous gas may occur.

6. When an air conditioning system charged with a large volume of refrigerant is installed in a small room, it is necessary to exercise care so that, even when refrigerant leaks, its concentration does not exceed the marginal level.

If the refrigerant gas leakage occurs and its concentration exceeds the marginal level, an oxygen starvation accident may result.

7. Be sure to carry out installation or removal according to the installation manual.
Improper installation may cause refrigeration trouble, water leakage, electric shock, fire, etc.
8. Unauthorized modifications to the air conditioner may be dangerous. If a breakdown occurs please call a qualified air conditioner technician or electrician.
Improper repair may result in water leakage, electric shock and fire, etc.

3-2. Refrigerant Piping Installation

3-2-1. Piping Materials and Joints Used

For the refrigerant piping installation, copper pipes and joints are mainly used. Copper pipes and joints suitable for the refrigerant must be chosen and installed. Furthermore, it is necessary to use clean copper pipes and joints whose interior surfaces are less affected by contaminants.

1. Copper Pipes

It is necessary to use seamless copper pipes which are made of either copper or copper alloy and it is desirable that the amount of residual oil is less than 40 mg/10 m. Do not use copper pipes having a collapsed, deformed or discolored portion (especially on the interior surface).

Otherwise, the expansion valve or capillary tube may become blocked with contaminants.

As an air conditioner using R410A incurs pressure higher than when using R22, it is necessary to choose adequate materials.

Thicknesses of copper pipes used with R410A are as shown in Table 3-2-1. Never use copper pipes thinner than 0.8 mm even when it is available on the market.

Table 3-2-1 Thicknesses of annealed copper pipes

		Thickness (mm)	
Nominal diameter	Outer diameter (mm)	R410A	R22
1/4	6.35	0.80	0.80
3/8	9.52	0.80	0.80
1/2	12.70	0.80	0.80
5/8	15.88	1.00	1.00

2. Joints

For copper pipes, flare joints or socket joints are used. Prior to use, be sure to remove all contaminants.

a) Flare Joints

Flare joints used to connect the copper pipes cannot be used for pipings whose outer diameter exceeds 20 mm. In such a case, socket joints can be used.

Sizes of flare pipe ends, flare joint ends and flare nuts are as shown in Tables 3-2-3 to 3-2-6 below.

b) Socket Joints

Socket joints are such that they are brazed for connections, and used mainly for thick pipings whose diameter is larger than 20 mm.

Thicknesses of socket joints are as shown in Table 3-2-2.

Table 3-2-2 Minimum thicknesses of socket joints

Nominal diameter	Reference outer diameter of copper pipe jointed (mm)	Minimum joint thickness (mm)
1/4	6.35	0.50
3/8	9.52	0.60
1/2	12.70	0.70
5/8	15.88	0.80

3-2-2. Processing of Piping Materials

When performing the refrigerant piping installation, care should be taken to ensure that water or dust does not enter the pipe interior, that no other oil than lubricating oils used in the installed air-water heat pump is used, and that refrigerant does not leak. When using lubricating oils in the piping processing, use such lubricating oils whose water content has been removed. When stored, be sure to seal the container with an airtight cap or any other cover.

1. Flare processing procedures and precautions

a) Cutting the Pipe

By means of a pipe cutter, slowly cut the pipe so that it is not deformed.

b) Removing Burrs and Chips

If the flared section has chips or burrs, refrigerant leakage may occur.

Carefully remove all burrs and clean the cut surface before installation.

c) Insertion of Flare Nut

d) Flare Processing

Make certain that a clamp bar and copper pipe have been cleaned.

By means of the clamp bar, perform the flare processing correctly.

Use either a flare tool for R410A or conventional flare tool.

Flare processing dimensions differ according to the type of flare tool. When using a conventional flare tool, be sure to secure "dimension A" by using a gauge for size adjustment.

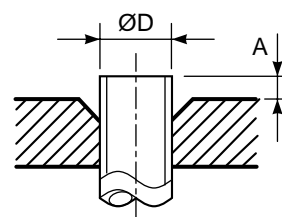

Fig. 3-2-1 Flare processing dimensions

Table 3-2-3 Dimensions related to flare processing for R410A

Nominal diameter	Outer diameter (mm)	Thickness (mm)	A (mm)		
			Flare tool for R410A clutch type	Conventional flare tool	
				Clutch type	Wing nut type
1/4	6.35	0.8	0 to 0.5	1.0 to 1.5	1.5 to 2.0
3/8	9.52	0.8	0 to 0.5	1.0 to 1.5	1.5 to 2.0
1/2	12.70	0.8	0 to 0.5	1.0 to 1.5	2.0 to 2.5
5/8	15.88	1.0	0 to 0.5	1.0 to 1.5	2.0 to 2.5

Table 3-2-4 Dimensions related to flare processing for R22

Nominal diameter	Outer diameter (mm)	Thickness (mm)	A (mm)		
			Flare tool for R22 clutch type	Conventional flare tool	
				Clutch type	Wing nut type
1/4	6.35	0.8	0 to 0.5	0.5 to 1.0	1.0 to 1.5
3/8	9.52	0.8	0 to 0.5	0.5 to 1.0	1.0 to 1.5
1/2	12.70	0.8	0 to 0.5	0.5 to 1.0	1.5 to 2.0
5/8	15.88	1.0	0 to 0.5	0.5 to 1.0	1.5 to 2.0

Table 3-2-5 Flare and flare nut dimensions for R410A

Nominal diameter	Outer diameter (mm)	Thickness (mm)	Dimension (mm)				Flare nut width (mm)
			A	B	C	D	
1/4	6.35	0.8	9.1	9.2	6.5	13	17
3/8	9.52	0.8	13.2	13.5	9.7	20	22
1/2	12.70	0.8	16.6	16.0	12.9	23	26
5/8	15.88	1.0	19.7	19.0	16.0	25	29

Table 3-2-6 Flare and flare nut dimensions for R22

Nominal diameter	Outer diameter (mm)	Thickness (mm)	Dimension (mm)				Flare nut width (mm)
			A	B	C	D	
1/4	6.35	0.8	9.0	9.2	6.5	13	17
3/8	9.52	0.8	13.0	13.5	9.7	20	22
1/2	12.70	0.8	16.2	16.0	12.9	20	24
5/8	15.88	1.0	19.7	19.0	16.0	23	27
3/4	19.05	1.0	23.3	24.0	19.2	34	36

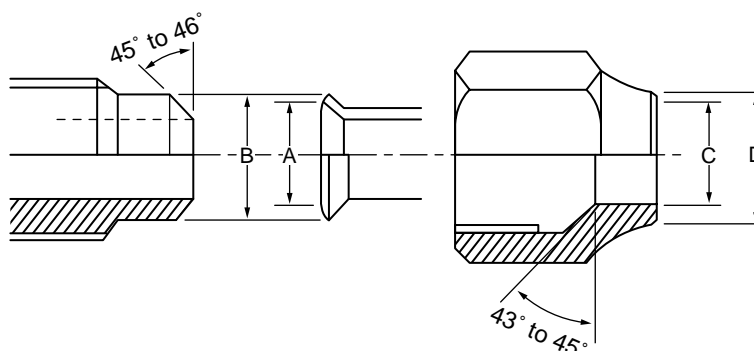

Fig. 3-2-2 Relations between flare nut and flare seal surface

2. Flare Connecting Procedures and Precautions

- Make sure that the flare and union portions do not have any scar or dust, etc.
- Correctly align the processed flare surface with the union axis.
- Tighten the flare with designated torque by means of a torque wrench. The tightening torque for R410A is the same as that for conventional R22. Incidentally, when the torque is weak, the gas leakage may occur. When it is strong, the flare nut may crack and may be made non-removable. When choosing the tightening torque, comply with values designated by manufacturers. Table 3-2-7 shows reference values.

NOTE :

When applying oil to the flare surface, be sure to use oil designated by the manufacturer. If any other oil is used, the lubricating oils may deteriorate and cause the compressor to burn out.

Table 3-2-7 Tightening torque of flare for R410A [Reference values]

Nominal diameter	Outer diameter (mm)	Tightening torque N•m (kgf•cm)	Tightening torque of torque wrenches available on the market N•m (kgf•cm)
1/4	6.35	14 to 18 (140 to 180)	16 (160), 18 (180)
3/8	9.52	33 to 42 (330 to 420)	42 (420)
1/2	12.70	50 to 62 (500 to 620)	55 (550)
5/8	15.88	63 to 77 (630 to 770)	65 (650)

3-3. Tools

3-3-1. Required Tools

The service port diameter of packed valve of the outdoor unit in the air-water heat pump using R410A is changed to prevent mixing of other refrigerant. To reinforce the pressure-resisting strength, flare processing dimensions and opposite side dimension of flare nut (For Ø12.7 copper pipe) of the refrigerant piping are lengthened.

The used refrigerating oil is changed, and mixing of oil may cause a trouble such as generation of sludge, clogging of capillary, etc. Accordingly, the tools to be used are classified into the following three types.

1. Tools exclusive for R410A (Those which cannot be used for conventional refrigerant (R22))
2. Tools exclusive for R410A, but can be also used for conventional refrigerant (R22)
3. Tools commonly used for R410A and for conventional refrigerant (R22)

The table below shows the tools exclusive for R410A and their interchangeability.

Tools exclusive for R410A (The following tools for R410A are required.)

Tools whose specifications are changed for R410A and their interchangeability

No.	Used tool	Usage	R410A air-water heat pump installation		Conventional air-water heat pump installation
			Existence of new equipment for R410A	Whether conventional equipment can be used	Whether new equipment can be used with conventional refrigerant
1	Flare tool	Pipe flaring	Yes	*(Note 1)	○
2	Copper pipe gauge for adjusting projection margin	Flaring by conventional flare tool	Yes	*(Note 1)	*(Note 1)
3	Torque wrench (For Ø12.7)	Connection of flare nut	Yes	✗	✗
4	Gauge manifold	Evacuating, refrigerant charge, run check, etc.	Yes	✗	✗
5	Charge hose				
6	Vacuum pump adapter	Vacuum evacuating	Yes	✗	○
7	Electronic balance for refrigerant charging	Refrigerant charge	Yes	✗	○
8	Refrigerant cylinder	Refrigerant charge	Yes	✗	✗
9	Leakage detector	Gas leakage check	Yes	✗	○
10	Charging cylinder	Refrigerant charge	(Note 2)	✗	✗

(Note 1) When flaring is carried out for R410A using the conventional flare tools, adjustment of projection margin is necessary. For this adjustment, a copper pipe gauge, etc. are necessary.

(Note 2) Charging cylinder for R410A is being currently developed.

General tools (Conventional tools can be used.)

In addition to the above exclusive tools, the following equipments which serve also for R22 are necessary as the general tools.

- | | | |
|---|-----------------------------|--|
| 1. Vacuum pump
Use vacuum pump by attaching vacuum pump adapter. | 4. Reamer | 9. Hole core drill (Ø65) |
| 2. Torque wrench (For Ø6.35, Ø9.52) | 5. Pipe bender | 10. Hexagon wrench (Opposite side 4mm) |
| 3. Pipe cutter | 6. Level vial | 11. Tape measure |
| | 7. Screwdriver (+, -) | 12. Metal saw |
| | 8. Spanner or Monkey wrench | |

Also prepare the following equipments for other installation method and run check.

- | | |
|----------------|---------------------------------|
| 1. Clamp meter | 3. Insulation resistance tester |
| 2. Thermometer | 4. Electroscop |

3-4. Recharging of Refrigerant

When it is necessary to recharge refrigerant, charge the specified amount of new refrigerant according to the following steps.

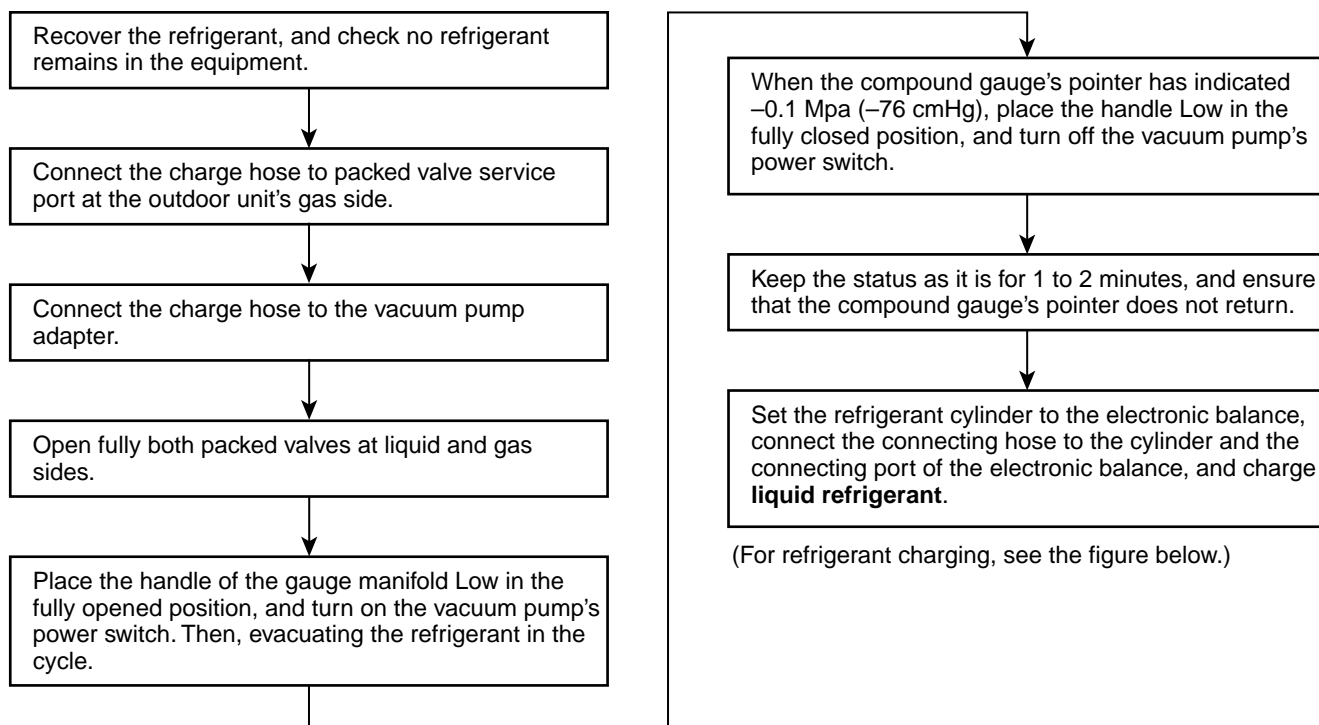

1. Never charge refrigerant exceeding the specified amount.
2. If the specified amount of refrigerant cannot be charged, charge refrigerant **bit by bit** in COOL mode.
3. Do not carry out additional charging.

When additional charging is carried out if refrigerant leaks, the refrigerant composition changes in the refrigeration cycle, that is characteristics of the air conditioner changes, refrigerant exceeding the specified amount is charged, and working pressure in the refrigeration cycle becomes abnormally high pressure, and may cause a rupture or personal injury.

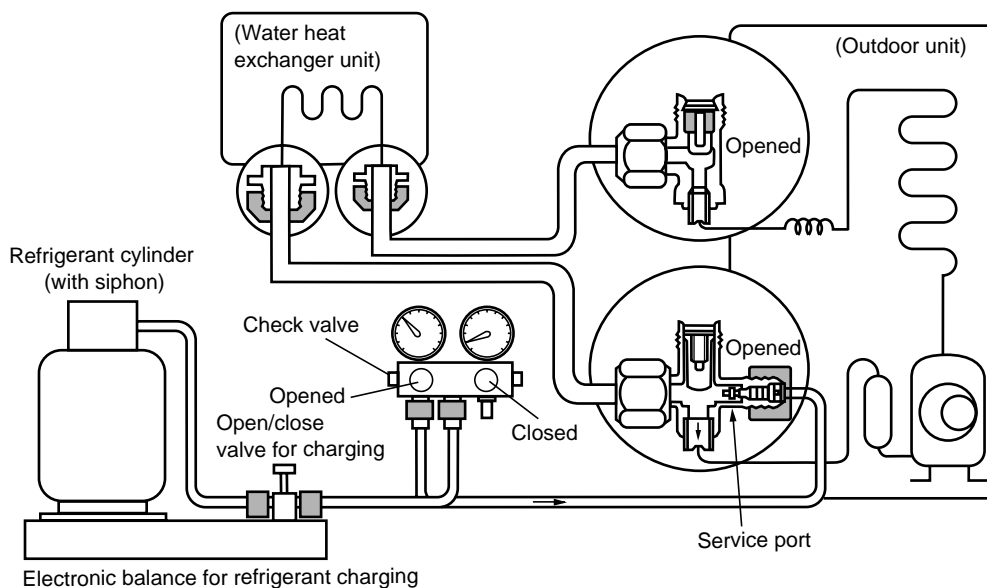
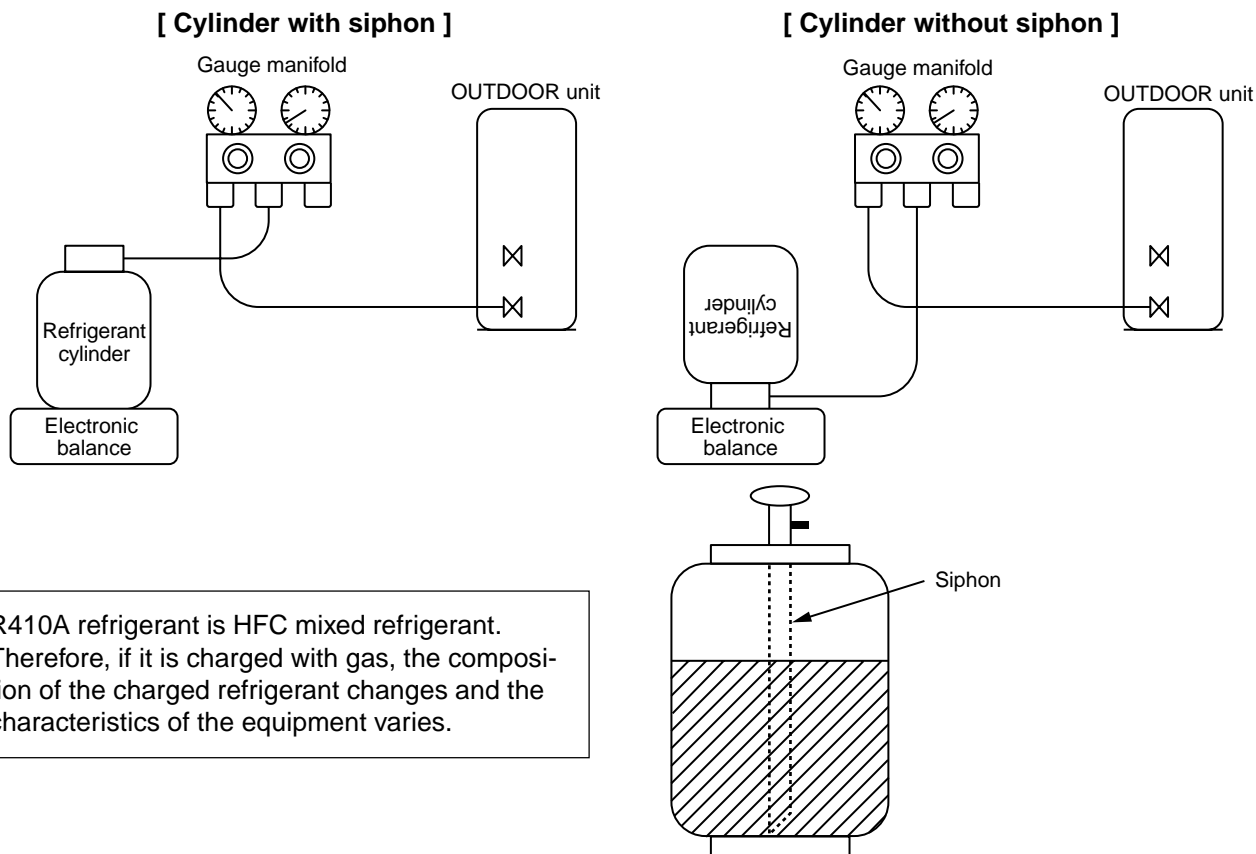

Fig. 3-4-1 Configuration of refrigerant charging

1. Be sure to make setting so that **liquid** can be charged.
2. When using a cylinder equipped with a siphon, liquid can be charged without turning it upside down.

It is necessary for charging refrigerant under condition of liquid because R410A is mixed type of refrigerant. Accordingly, when charging refrigerant from the refrigerant cylinder to the equipment, charge it turning the cylinder upside down if cylinder is not equipped with siphon.



R410A refrigerant is HFC mixed refrigerant. Therefore, if it is charged with gas, the composition of the charged refrigerant changes and the characteristics of the equipment varies.

Fig. 3-4-2

3-5. Brazing of Pipes

3-5-1. Materials for Brazing

1. Silver brazing filler

Silver brazing filler is an alloy mainly composed of silver and copper. It is used to join iron, copper or copper alloy, and is relatively expensive though it excels in solderability.

2. Phosphor bronze brazing filler

Phosphor bronze brazing filler is generally used to join copper or copper alloy.

3. Low temperature brazing filler

Low temperature brazing filler is generally called solder, and is an alloy of tin and lead. Since it is weak in adhesive strength, do not use it for refrigerant pipes.

1. Phosphor bronze brazing filler tends to react with sulfur and produce a fragile compound water solution, which may cause a gas leakage. Therefore, use any other type of brazing filler at a hot spring resort, etc., and coat the surface with a paint.
2. When performing brazing again at time of servicing, use the same type of brazing filler.

3-5-2. Flux

1. Reason why flux is necessary

- By removing the oxide film and any foreign matter on the metal surface, it assists the flow of brazing filler.
- In the brazing process, it prevents the metal surface from being oxidized.
- By reducing the brazing filler's surface tension, the brazing filler adheres better to the treated metal.

2. Characteristics required for flux

- Activated temperature of flux coincides with the brazing temperature.
- Due to a wide effective temperature range, flux is hard to carbonize.
- It is easy to remove slag after brazing.
- The corrosive action to the treated metal and brazing filler is minimum.
- It excels in coating performance and is harmless to the human body.

As the flux works in a complicated manner as described above, it is necessary to select an adequate type of flux according to the type and shape of treated metal, type of brazing filler and brazing method, etc.

3. Types of flux

• Noncorrosive flux

Generally, it is a compound of borax and boric acid.

It is effective in case where the brazing temperature is higher than 800°C.

• Activated flux

Most of fluxes generally used for silver brazing are this type.

It features an increased oxide film removing capability due to the addition of compounds such as potassium fluoride, potassium chloride and sodium fluoride to the borax-boric acid compound.

4. Piping materials for brazing and used brazing filler/flux

Piping material	Used brazing filler	Used flux
Copper - Copper	Phosphor copper	Do not use
Copper - Iron	Silver	Paste flux
Iron - Iron	Silver	Vapor flux

1. Do not enter flux into the refrigeration cycle.
2. When chlorine contained in the flux remains within the pipe, the lubricating oil deteriorates. Therefore, use a flux which does not contain chlorine.
3. When adding water to the flux, use water which does not contain chlorine (e.g. distilled water or ion-exchange water).
4. Remove the flux after brazing.

3-5-3. Brazing

As brazing work requires sophisticated techniques, experiences based upon a theoretical knowledge, it must be performed by a person qualified.

In order to prevent the oxide film from occurring in the pipe interior during brazing, it is effective to proceed with brazing while letting dry Nitrogen gas (N₂) flow.

Never use gas other than Nitrogen gas.

1. Brazing method to prevent oxidation

- 1) Attach a reducing valve and a flow-meter to the Nitrogen gas cylinder.
- 2) Use a copper pipe to direct the piping material, and attach a flow-meter to the cylinder.
- 3) Apply a seal onto the clearance between the piping material and inserted copper pipe for Nitrogen in order to prevent backflow of the Nitrogen gas.
- 4) When the Nitrogen gas is flowing, be sure to keep the piping end open.
- 5) Adjust the flow rate of Nitrogen gas so that it is lower than 0.05 m³/Hr or 0.02 MPa (0.2kgf/cm²) by means of the reducing valve.
- 6) After performing the steps above, keep the Nitrogen gas flowing until the pipe cools down to a certain extent (temperature at which pipes are touchable with hands).
- 7) Remove the flux completely after brazing.

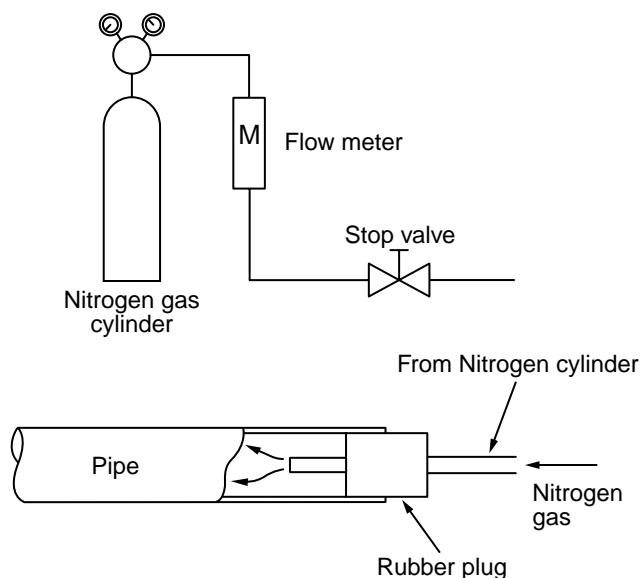
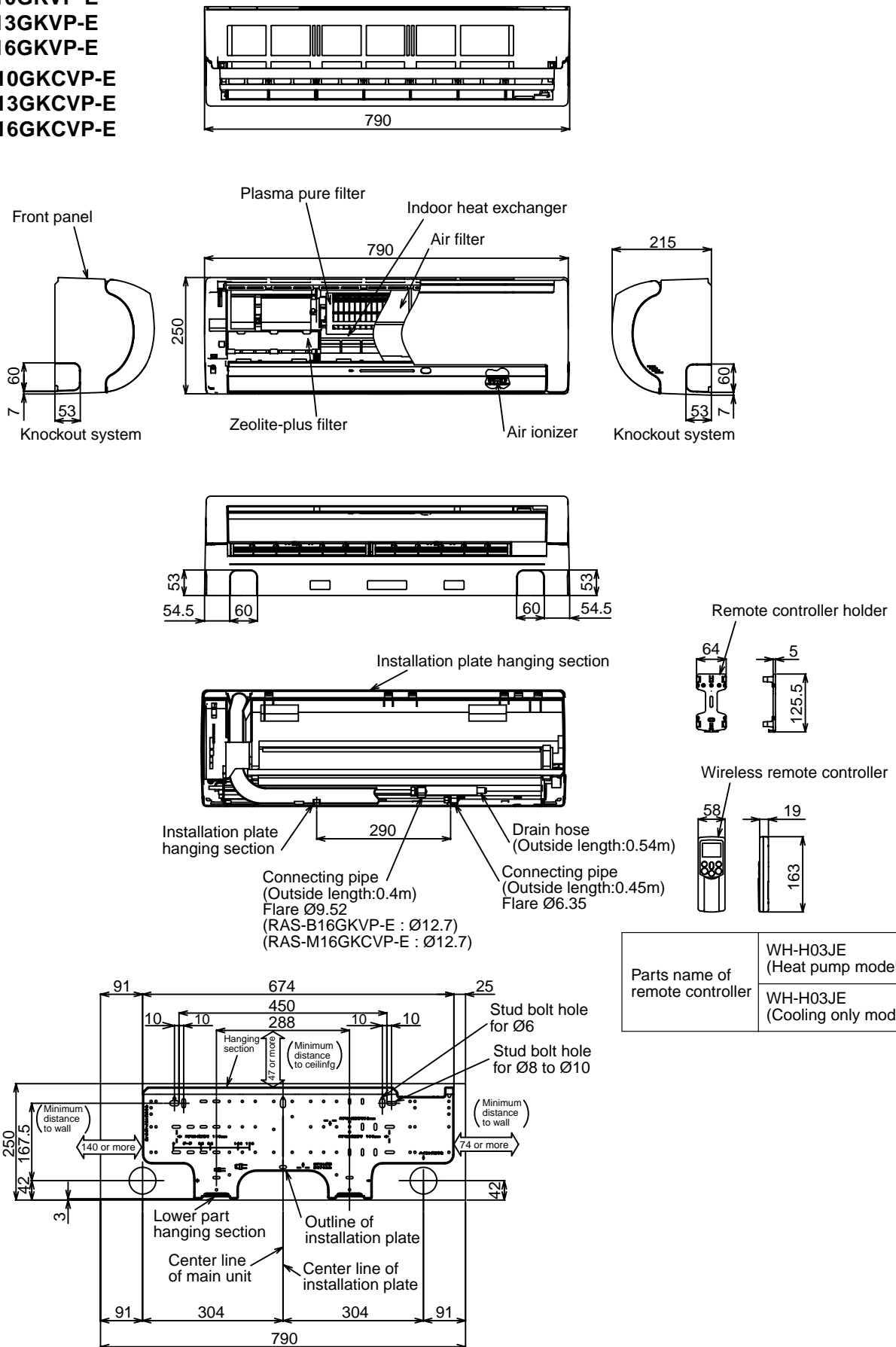

Fig. 3-5-1 Prevention of oxidation during brazing

4. CONSTRUCTION VIEWS

4-1. Indoor Unit

RAS-B10GKVP-E
 RAS-B13GKVP-E
 RAS-B16GKVP-E
 RAS-M10GKVP-E
 RAS-M13GKVP-E
 RAS-M16GKVP-E



4-2. Outdoor Unit

RAS-4M27GAV-E, RAS-4M27GACV-E, RAS-3M26GAV-E

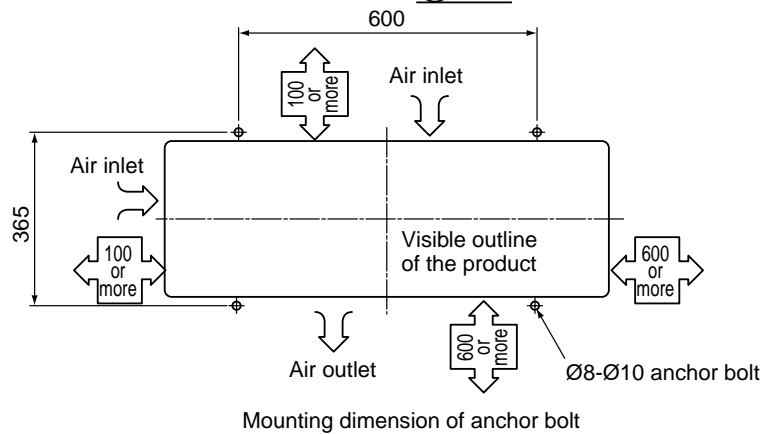
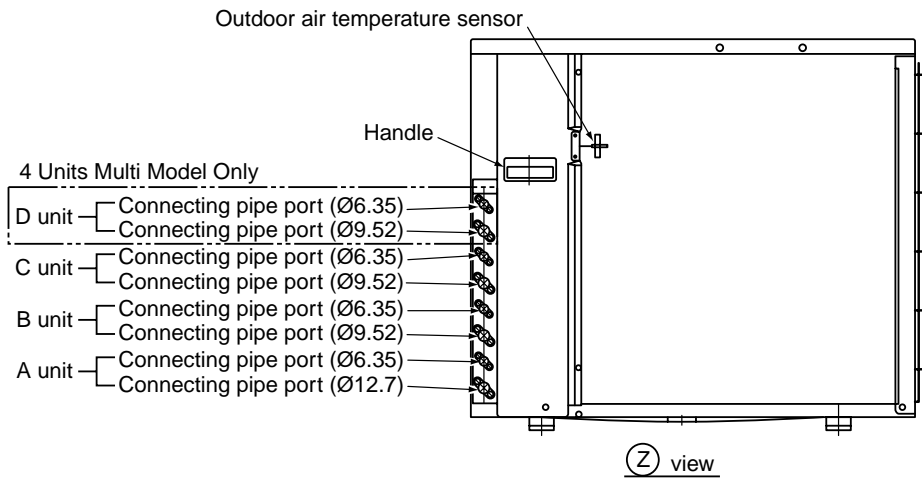
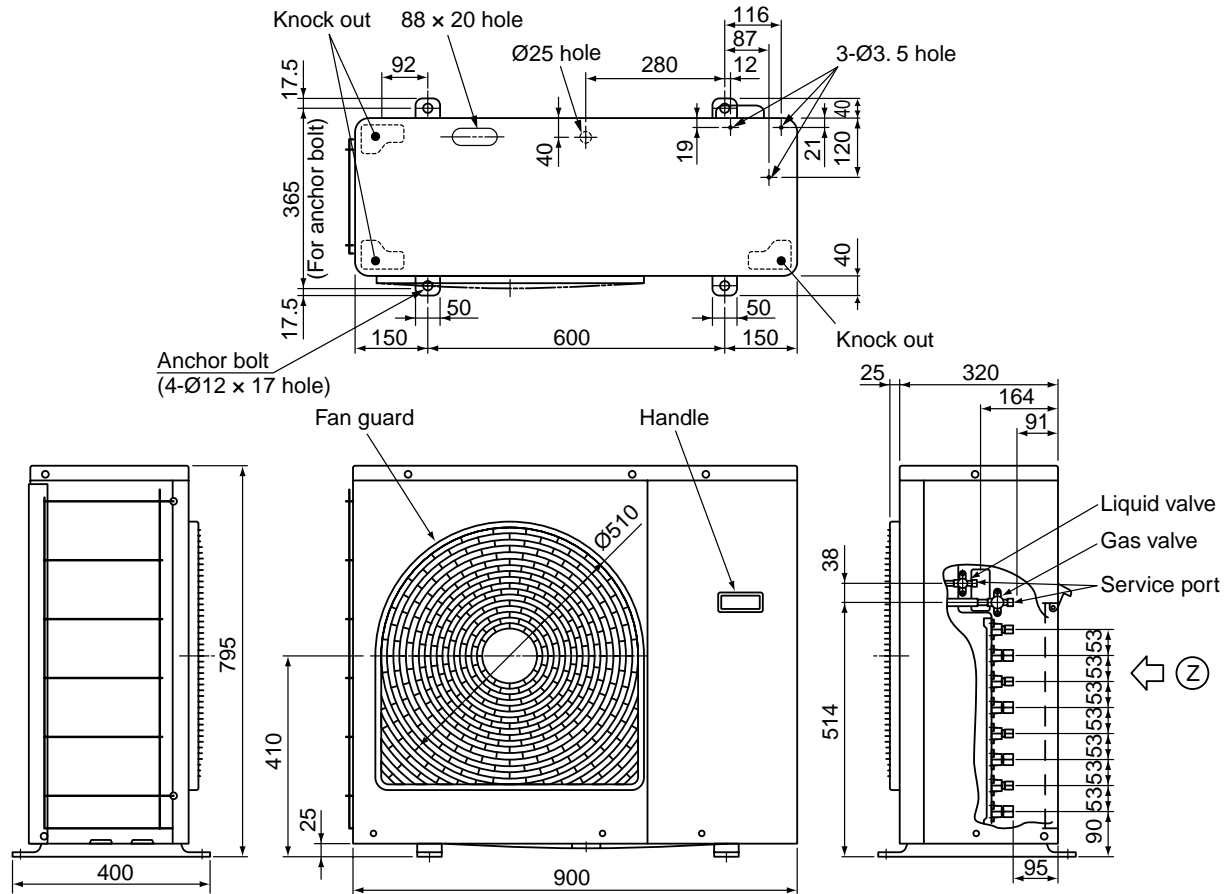

5. WIRING DIAGRAM

5-1. Indoor Unit

RAS-B10GKVP-E, RAS-B13GKVP-E, RAS-B16GKVP-E (Heat pump models)
 RAS-M10GKVP-E, RAS-M13GKVP-E, RAS-M16GKVP-E (Cooling only models)

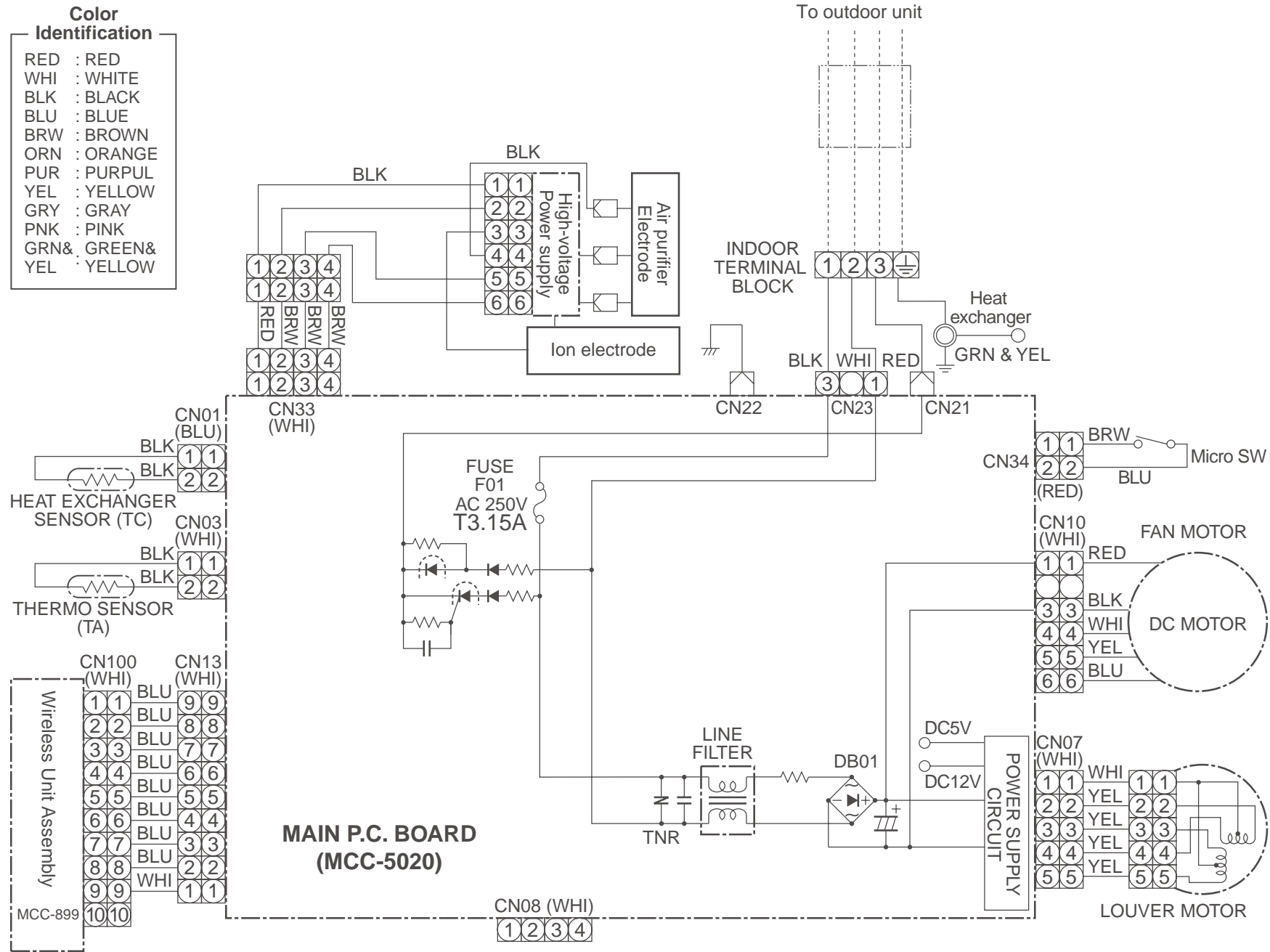

5-2. Outdoor Unit

RAS-4M27GAV-E, RAS-4M27GACV-E, RAS-3M26GAV-E

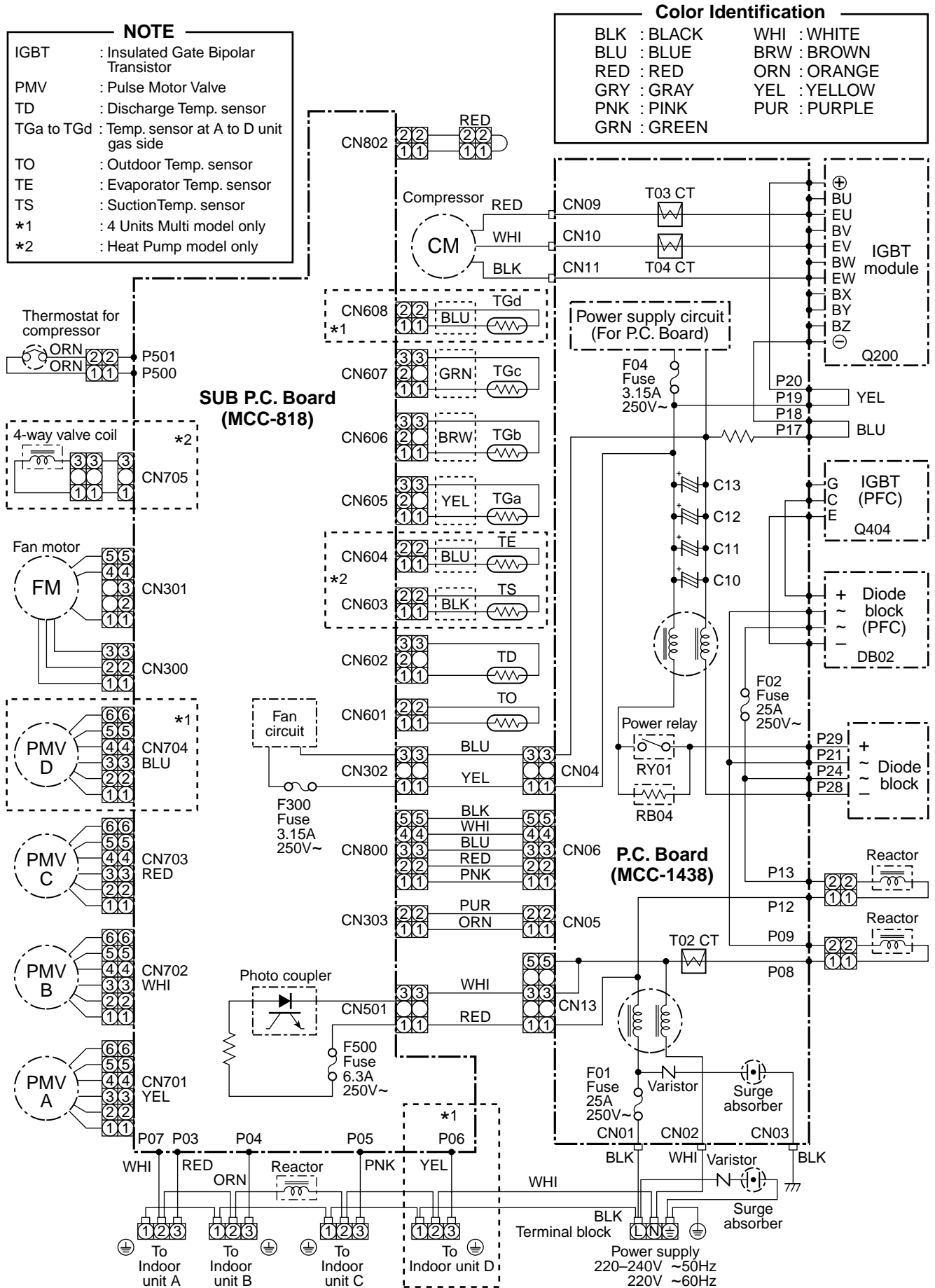

6. SPECIFICATIONS OF ELECTRICAL PARTS

6-1. Indoor Unit

**RAS-B10GKVP-E, RAS-B13GKVP-E, RAS-B16GKVP-E
RAS-M10GKVP-E, RAS-M13GKVP-E, RAS-M16GKVP-E**

No.	Parts name	Type	Specifications
1	Fan motor (for indoor)	MF-280-30-5R	DC280-340V, 30W
2	Room temp. sensor (TA-sensor)	(-)	10kΩ at 25°C
3	Heat exchanger temp. sensor (TC-sensor)	(-)	10kΩ at 25°C
4	Louver motor	MP24Z	Output (Rated) 1W, 16 poles, DC12V

6-2. Outdoor Unit

RAS-4M27GAV-E, RAS-4M27GACV-E, RAS-3M26GAV-E

No.	Parts name	Model name	Rating
1	SC coil (Noise filter) (L01)	ADR25H200RBTB	AC 250V, 20A, 0.88mH
	SC coil (Noise filter) (L02)	SC-20-S03J	AC 250V, 20A, 0.3mH
2	DC-DC transformer	SWT-75	Primary side DC 240 – 390V Secondary side : 7V × 1, 13V × 1 16V × 3
3	Outside fan motor	ICF-140-63-2R	DC 140V, 63W
*2 4	Relay (4-way valve)	G5N-1A	Coil : DC 12V Contact : 2A, AC250V
5	Relay (Power relay)	G4A-1A-PE	Coil : DC 12V Contact : 20A, AC250V
6	Discharge temp. sensor (TD-sensor)	(Inverter attached)	64kΩ (20°C)
7	Outside air temp. sensor (TO-sensor)	(Inverter attached)	10kΩ (25°C)
8	Temp. sensor at A room gas side (TGA-sensor)	(Inverter attached)	10kΩ (25°C)
9	Temp. sensor at B room gas side (TGB-sensor)	(Inverter attached)	10kΩ (25°C)
10	Temp. sensor at C room gas side (TGC-sensor)	(Inverter attached)	10kΩ (25°C)
*1 11	Temp. Sensor at D room gas side (TGD-sensor)	(Inverter attached)	10kΩ (25°C)
*2 12	Evaporator temp. sensor (TE-sensor)	(Inverter attached)	10kΩ (25°C)
*2 13	Suction temp. sensor (TS-sensor)	(Inverter attached)	10kΩ (25°C)
14	Terminal block (6P)	—	AC 250V, 20A
15	Terminal block (3P)	—	AC 250V, 20A
16	Fuse	For protection of switching power source (F04)	AC 250V, 3.15A
		For protection of power factor converter circuit breakage	AC 250V, 25A
		For protection of inverter input overcurrent	AC 250V, 25A
		For protection of switching power source (F300)	AC 250V, 3.15A
		For protection of power source	AC 250V, 6.3A
17	Electrolytic capacitor	LLQ2G761KHUATF	DC 400V, 760μF
18	Transistor module	6MBI40SS-060-51A	600V, 40A
19	Compressor	DA220A2F-20L	3 phases, 4 poles, 2000W
20	Compressor thermo.	US622KXTMQO	OFF : 125 ± 4°C, ON : 90 ± 5°C
21	Diode block (Rectifire)	S30VT80	AC 800V, 30A
22	Reactor (Main)	CH-47-Z-T	L = 8mH, 16A
23	Reactor (Sub)	CH-43-Z-T	L = 10mH, 1A

NOTE) *1 : 4 unit multi model only.
*2 : Heat pump model only.

7. REFRIGERANT CYCLE DIAGRAM

RAS-B10GKVP-E, RAS-B13GKVP-E, RAS-B16GKVP-E / RAS-4M27GAV-E

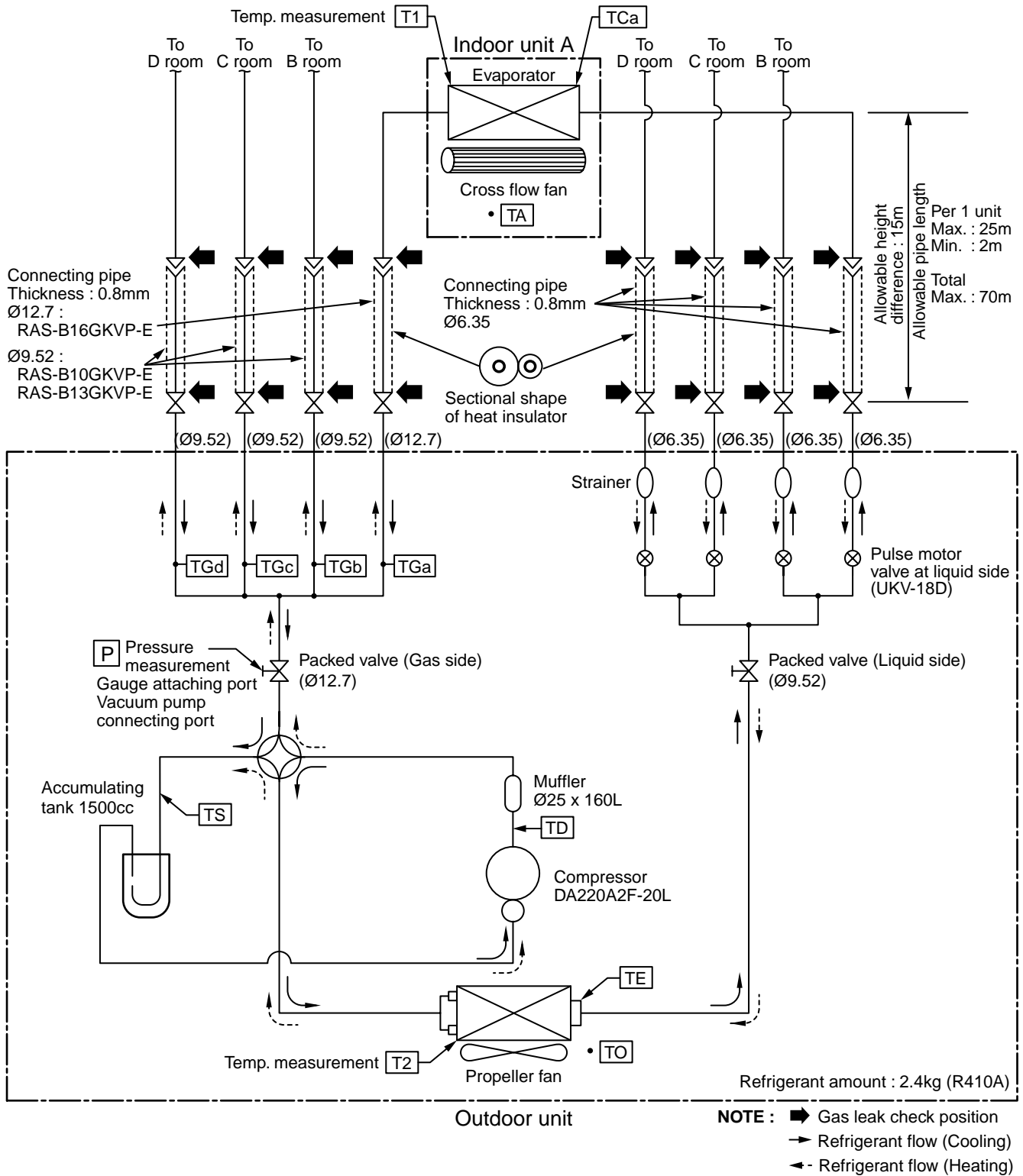

NOTE :

- The maximum pipe length of this air conditioner is 70 m. The additional charging of refrigerant is unnecessary because this conditioner is designed with charge-less specification.
- Connection of only one indoor unit is unavailable. Two or more indoor units should be connected.

RAS-M10GKCVP-E, RAS-M13GKCVP-E, RAS-M16GKCVP-E / RAS-4M27GACV-E

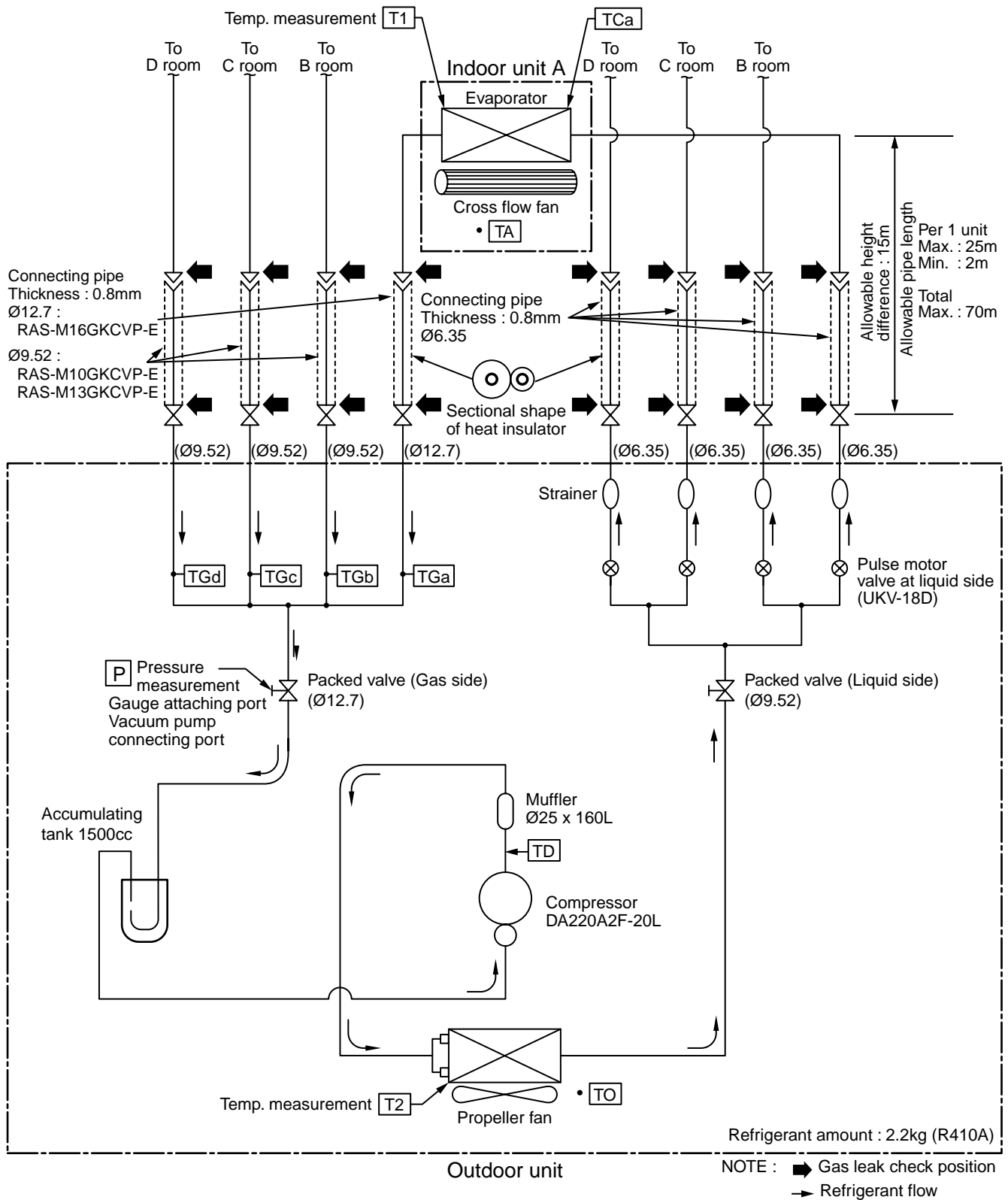

NOTE :

- The maximum pipe length of this air conditioner is 70 m. The additional charging of refrigerant is unnecessary because this conditioner is designed with charge-less specification.

RAS-B10GKVP-E, RAS-B13GKVP-E, RAS-B16GKVP-E / RAS-3M26GAV-E

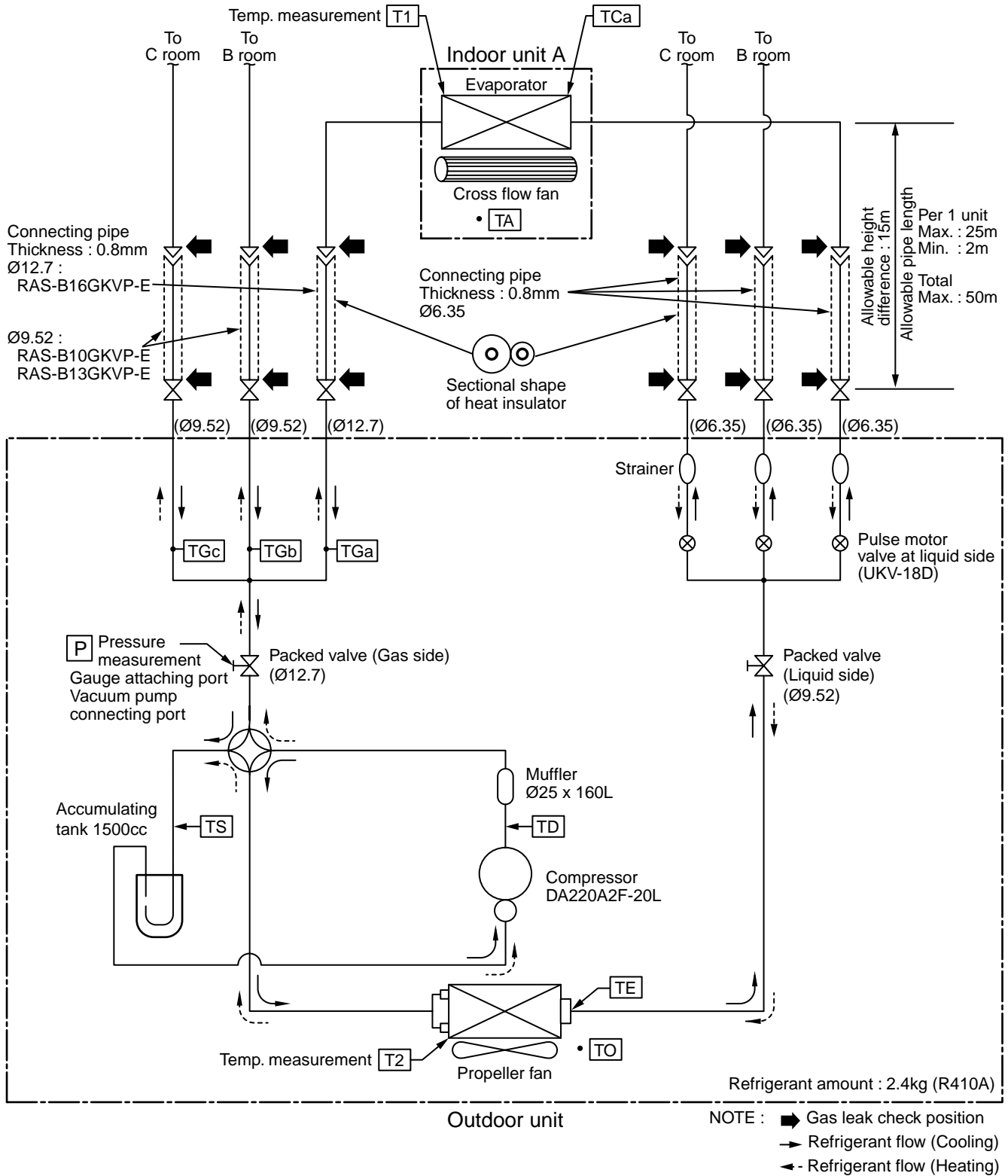

NOTE :

- The maximum pipe length of this air conditioner is 50 m. The additional charging of refrigerant is unnecessary because this conditioner is designed with charge-less specification.
- Connection of only one indoor unit is unavailable. Two or more indoor units should be connected.

7-2. Operation Data

Outdoor Unit : RAS-4M27GAV-E

<Cooling>

Temperature condition		No. of operating units	Operating combination (Unit)				Standard pressure P (MPa)	Heat exchanger pipe temp.		Indoor fan	Outdoor fan	Compressor revolution (rps)
Indoor	Outdoor		A	B	C	D		T1 (°C)	T2 (°C)			
27 / 19	35 / -	1 unit	10	-	-	-	0.8 to 1.0	9 to 11	45 to 47	High	MED	22
			13	-	-	-	0.7 to 0.9	8 to 10	46 to 48	High	MED	35
			16	-	-	-	0.6 to 0.8	7 to 9	47 to 49	High	MED	45
		2 units	10	10	-	-	0.8 to 1.0	10 to 12	47 to 49	High	MED	42
			13	10	-	-	0.8 to 1.0	10 to 12	48 to 50	High	MED	46
			16	10	-	-	0.8 to 1.0	10 to 12	49 to 51	High	MED	50
			13	13	-	-	0.8 to 1.0	10 to 12	50 to 52	High	MED	54
			16	13	-	-	0.7 to 0.9	9 to 11	51 to 53	High	MED	58
			16	16	-	-	0.7 to 0.9	9 to 11	52 to 54	High	MED	62
		3 units	10	10	10	-	0.8 to 1.0	11 to 13	51 to 53	High	MED	60
			13	10	10	-	0.8 to 1.0	11 to 13	51 to 53	High	MED	60
			16	10	10	-	0.8 to 1.0	11 to 13	51 to 53	High	MED	60
			13	13	10	-	0.8 to 1.0	11 to 13	51 to 53	High	MED	60
			16	13	10	-	0.8 to 1.0	11 to 13	51 to 53	High	MED	60
			13	13	13	-	0.8 to 1.0	11 to 13	51 to 53	High	MED	60
			16	16	10	-	0.8 to 1.0	11 to 13	51 to 53	High	MED	60
			16	13	13	-	0.8 to 1.0	11 to 13	51 to 53	High	MED	60
			16	16	13	-	0.8 to 1.0	12 to 14	51 to 53	High	MED	60
			16	16	16	-	0.8 to 1.0	12 to 14	51 to 53	High	MED	60
		4 units	10	10	10	10	0.9 to 1.1	12 to 14	51 to 53	High	MED	61
			13	10	10	10	0.9 to 1.1	12 to 14	51 to 53	High	MED	61
			16	10	10	10	0.9 to 1.1	12 to 14	51 to 53	High	MED	61
			13	13	10	10	0.9 to 1.1	12 to 14	51 to 53	High	MED	61
			16	13	10	10	0.9 to 1.1	12 to 14	51 to 53	High	MED	61
			13	13	13	10	0.9 to 1.1	12 to 14	51 to 53	High	MED	61
			16	13	13	10	0.9 to 1.1	12 to 14	51 to 53	High	MED	62
			16	16	10	10	0.9 to 1.1	12 to 14	51 to 53	High	MED	62

NOTES :

1. Measure surface temperature of heat exchanger pipe around center of heat exchanger path U bent. (Thermistor thermometer)
2. Connecting piping condition : 5 meters x 4 units (5m/each indoor unit)

Outdoor Unit : RAS-4M27GAV-E

<Heating>

Temperature condition		No. of operating units	Operating combination (Unit)				Standard pressure P (MPa)	Heat exchanger pipe temp.		Indoor fan	Outdoor fan	Compressor revolution (rps)
Indoor	Outdoor		A	B	C	D		T1 (°C)	T2 (°C)			
20 / -	7 / 6	1 unit	10	-	-	-	2.7 to 2.9	44 to 46	2 to 4	High	MED	41
			13	-	-	-	3.2 to 3.4	52 to 54	2 to 4	High	MED	52
			16	-	-	-	3.6 to 3.9	53 to 55	2 to 4	High	MED	56
		2 units	10	10	-	-	2.7 to 2.9	45 to 47	0 to 2	High	MED	62
			13	10	-	-	2.8 to 3.0	45 to 47	0 to 2	High	MED	64
			16	10	-	-	2.9 to 3.1	46 to 48	0 to 2	High	MED	66
			13	13	-	-	2.9 to 3.1	46 to 48	0 to 2	High	MED	67
			16	13	-	-	3.0 to 3.2	47 to 49	-1 to 1	High	MED	69
			16	16	-	-	3.1 to 3.3	48 to 50	-1 to 1	High	MED	71
		3 units	10	10	10	-	2.3 to 2.5	38 to 40	-1 to 1	High	MED	72
			13	10	10	-	2.3 to 2.5	38 to 40	-1 to 1	High	MED	72
			16	10	10	-	2.3 to 2.5	38 to 40	-1 to 1	High	MED	72
			13	13	10	-	2.3 to 2.5	38 to 40	-1 to 1	High	MED	73
			16	13	10	-	2.3 to 2.5	38 to 40	-1 to 1	High	MED	73
			13	13	13	-	2.3 to 2.5	38 to 40	-1 to 1	High	MED	73
			16	16	10	-	2.3 to 2.5	38 to 40	-1 to 1	High	MED	73
			16	13	13	-	2.5 to 2.7	37 to 39	-2 to 0	High	MED	74
			16	16	13	-	2.5 to 2.7	37 to 39	-2 to 0	High	MED	74
			16	16	16	-	2.5 to 2.7	37 to 39	-2 to 0	High	MED	74
		4 units	10	10	10	10	2.0 to 2.2	33 to 35	-2 to 0	High	MED	72
			13	10	10	10	2.0 to 2.2	33 to 35	-2 to 0	High	MED	72
			16	10	10	10	2.0 to 2.2	33 to 35	-2 to 0	High	MED	73
			13	13	10	10	2.0 to 2.2	33 to 35	-2 to 0	High	MED	73
			16	13	10	10	2.0 to 2.2	33 to 35	-2 to 0	High	MED	73
			13	13	13	10	2.0 to 2.2	33 to 35	-2 to 0	High	MED	73
			16	13	13	10	2.0 to 2.2	33 to 35	-2 to 0	High	MED	74
			16	16	10	10	2.0 to 2.2	33 to 35	-2 to 0	High	MED	74

NOTES :

1. Measure surface temperature of heat exchanger pipe around center of heat exchanger path U bent. (Thermistor thermometer)
2. Connecting piping condition : 5 meters x 4 units (5m/each indoor unit)

Outdoor Unit : RAS-4M27GACV-E

<Cooling>

Temperature condition		No. of operating units	Operating combination (Unit)				Standard pressure P (MPa)	Heat exchanger pipe temp.		Indoor fan	Outdoor fan	Compressor revolution (rps)
Indoor	Outdoor		A	B	C	D		T1 (°C)	T2 (°C)			
27 / 19	35 / -	1 unit	10	-	-	-	0.8 to 1.0	9 to 11	45 to 47	High	MED	22
			13	-	-	-	0.7 to 0.9	8 to 10	46 to 48	High	MED	35
			16	-	-	-	0.6 to 0.8	7 to 9	47 to 49	High	MED	45
		2 units	10	10	-	-	0.8 to 1.0	10 to 12	47 to 49	High	MED	42
			13	10	-	-	0.8 to 1.0	10 to 12	48 to 50	High	MED	46
			16	10	-	-	0.8 to 1.0	10 to 12	49 to 51	High	MED	50
			13	13	-	-	0.8 to 1.0	10 to 12	50 to 51	High	MED	54
			16	13	-	-	0.7 to 0.9	9 to 11	51 to 53	High	MED	58
			16	16	-	-	0.7 to 0.9	9 to 11	52 to 54	High	MED	62
		3 units	10	10	10	-	0.8 to 1.0	11 to 13	51 to 53	High	MED	60
			13	10	10	-	0.8 to 1.0	11 to 13	51 to 53	High	MED	60
			16	10	10	-	0.8 to 1.0	11 to 13	51 to 53	High	MED	60
			13	13	10	-	0.8 to 1.0	11 to 13	51 to 53	High	MED	60
			16	13	10	-	0.8 to 1.0	11 to 13	51 to 53	High	MED	60
			13	13	13	-	0.8 to 1.0	11 to 13	51 to 53	High	MED	60
			16	16	10	-	0.8 to 1.0	11 to 13	51 to 53	High	MED	60
			16	13	13	-	0.8 to 1.0	11 to 13	51 to 53	High	MED	60
			16	16	13	-	0.8 to 1.0	12 to 14	51 to 53	High	MED	60
			16	16	16	-	0.8 to 1.0	12 to 14	51 to 53	High	MED	60
		4 units	10	10	10	10	0.9 to 1.1	12 to 14	51 to 53	High	MED	61
			13	10	10	10	0.9 to 1.1	12 to 14	51 to 53	High	MED	61
			16	10	10	10	0.9 to 1.1	12 to 14	51 to 53	High	MED	61
			13	13	10	10	0.9 to 1.1	12 to 14	51 to 53	High	MED	61
			16	13	10	10	0.9 to 1.1	12 to 14	51 to 53	High	MED	61
			13	13	13	10	0.9 to 1.1	12 to 14	51 to 53	High	MED	61
			16	13	13	10	0.9 to 1.1	12 to 14	51 to 53	High	MED	62
			16	16	10	10	0.9 to 1.1	12 to 14	51 to 53	High	MED	62

NOTES :

1. Measure surface temperature of heat exchanger pipe around center of heat exchanger path U bent. (Thermistor thermometer)
2. Connecting piping condition : 5 meters x 4 units (5m/each indoor unit)

Outdoor Unit : RAS-3M26GAV-E

<Cooling>

Temperature condition		No. of operating units	Operating combination (Unit)			Standard pressure P (MPa)	Heat exchanger pipe temp.		Indoor fan	Outdoor fan	Compressor revolution (rps)
Indoor	Outdoor		A	B	C		T1 (°C)	T2 (°C)			
27 / 19	35 / -	1 unit	10	-	-	0.8 to 1.0	9 to 11	45 to 47	High	MED	22
			13	-	-	0.7 to 0.9	8 to 10	46 to 48	High	MED	35
			16	-	-	0.6 to 0.8	7 to 9	47 to 49	High	MED	45
		2 units	10	10	-	0.8 to 1.0	10 to 12	47 to 49	High	MED	42
			13	10	-	0.8 to 1.0	10 to 12	48 to 50	High	MED	46
			16	10	-	0.8 to 1.0	10 to 12	49 to 51	High	MED	50
			13	13	-	0.8 to 1.0	10 to 12	50 to 51	High	MED	54
			16	13	-	0.7 to 0.9	9 to 11	51 to 53	High	MED	58
			16	16	-	0.7 to 0.9	9 to 11	52 to 54	High	MED	62
		3 units	10	10	10	0.8 to 1.0	11 to 13	51 to 53	High	MED	60
			13	10	10	0.8 to 1.0	11 to 13	51 to 53	High	MED	60
			16	10	10	0.8 to 1.0	11 to 13	51 to 53	High	MED	60
			13	13	10	0.8 to 1.0	11 to 13	51 to 53	High	MED	60
			16	13	10	0.8 to 1.0	11 to 13	51 to 53	High	MED	60
			13	13	13	0.8 to 1.0	11 to 13	51 to 53	High	MED	60
16	16		10	0.8 to 1.0	11 to 13	51 to 53	High	MED	60		
16	13		13	0.8 to 1.0	11 to 13	51 to 53	High	MED	60		
		16	16	13	0.8 to 1.0	12 to 14	51 to 53	High	MED	60	

NOTES :

1. Measure surface temperature of heat exchanger pipe around center of heat exchanger path U bent. (Thermistor thermometer)
2. Connecting piping condition : 5 meters x 4 units (5m/each indoor unit)

Outdoor Unit : RAS-3M26GAV-E

<Heating>

Temperature condition		No. of operating units	Operating combination (Unit)			Standard pressure P (MPa)	Heat exchanger pipe temp.		Indoor fan	Outdoor fan	Compressor revolution (rps)
Indoor	Outdoor		A	B	C		T1 (°C)	T2 (°C)			
27 / -	7 / 6	1 unit	10	-	-	2.6 to 2.8	44 to 46	2 to 4	High	MED	40
			13	-	-	3.3 to 3.5	52 to 54	1 to 3	High	MED	50
			16	-	-	3.5 to 3.7	55 to 57	1 to 3	High	MED	53
		2 units	10	10	-	2.7 to 2.9	45 to 47	0 to 2	High	MED	62
			13	10	-	2.8 to 3.0	45 to 47	0 to 2	High	MED	63
			16	10	-	2.9 to 3.1	46 to 48	0 to 2	High	MED	65
			13	13	-	2.9 to 3.1	46 to 48	0 to 2	High	MED	66
			16	13	-	3.1 to 3.3	47 to 49	0 to 2	High	MED	68
			16	16	-	3.3 to 3.5	50 to 52	0 to 2	High	MED	70
		3 units	10	10	10	2.3 to 2.5	38 to 40	-1 to 1	High	MED	72
			13	10	10	2.3 to 2.5	38 to 40	-1 to 1	High	MED	72
			16	10	10	2.3 to 2.5	38 to 40	-1 to 1	High	MED	72
			13	13	10	2.3 to 2.5	38 to 40	-1 to 1	High	MED	73
			16	13	10	2.3 to 2.5	38 to 40	-1 to 1	High	MED	73
			13	13	13	2.3 to 2.5	38 to 40	-1 to 1	High	MED	73
16	16		10	2.3 to 2.5	38 to 40	-1 to 1	High	MED	73		
16	13		13	2.5 to 2.7	37 to 39	-2 to 0	High	MED	74		
16	16	13	2.5 to 2.7	37 to 39	-2 to 0	High	MED	74			

NOTES :

1. Measure surface temperature of heat exchanger pipe around center of heat exchanger path U bent. (Thermistor thermometer)
2. Connecting piping condition : 5 meters x 4 units (5m/each indoor unit)

8. CONTROL BLOCK DIAGRAM

8-1. Indoor Unit

RAS-B10GKVP-E, RAS-B13GKVP-E, RAS-B16GKVP-E

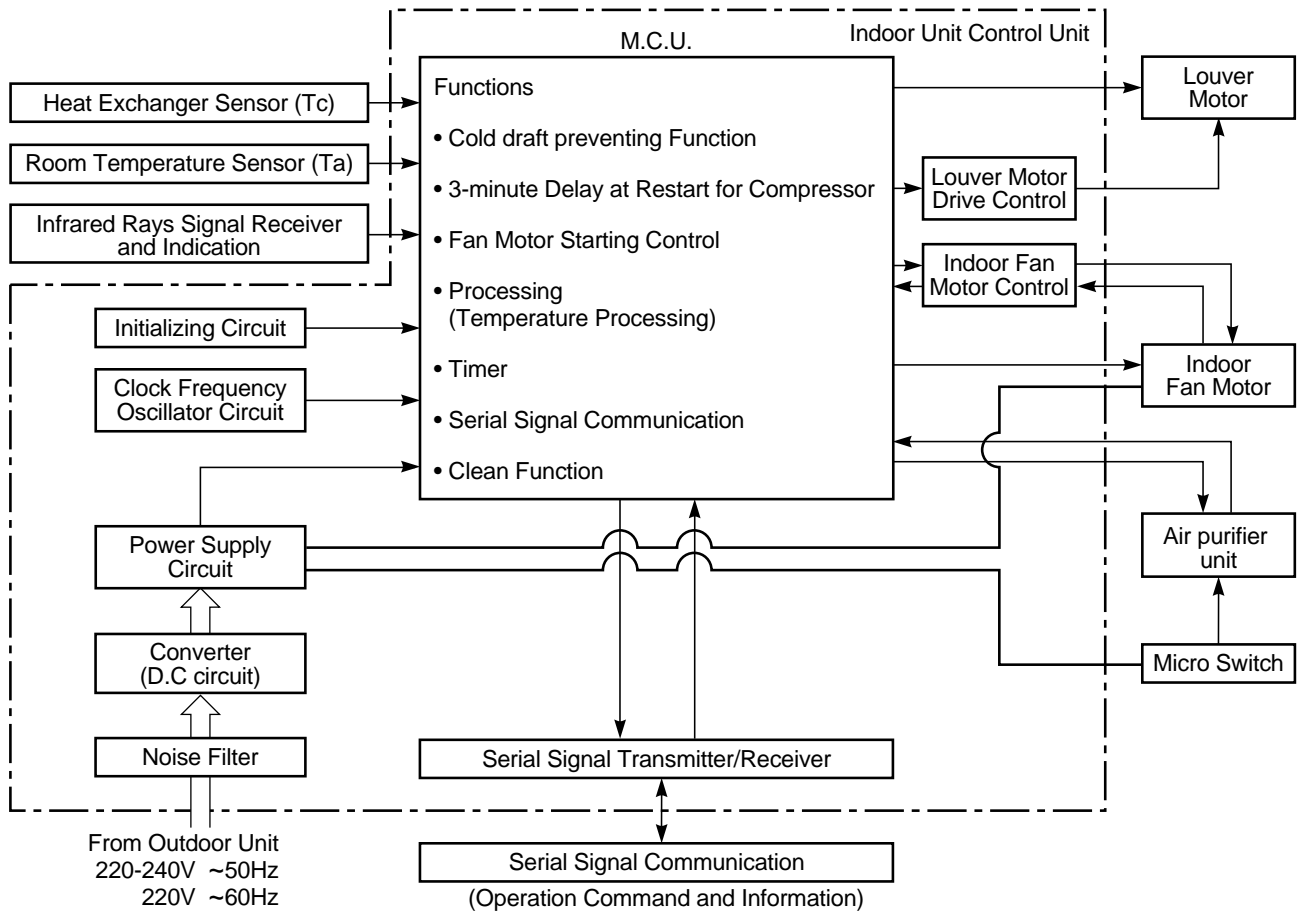

REMOTE CONTROLLER

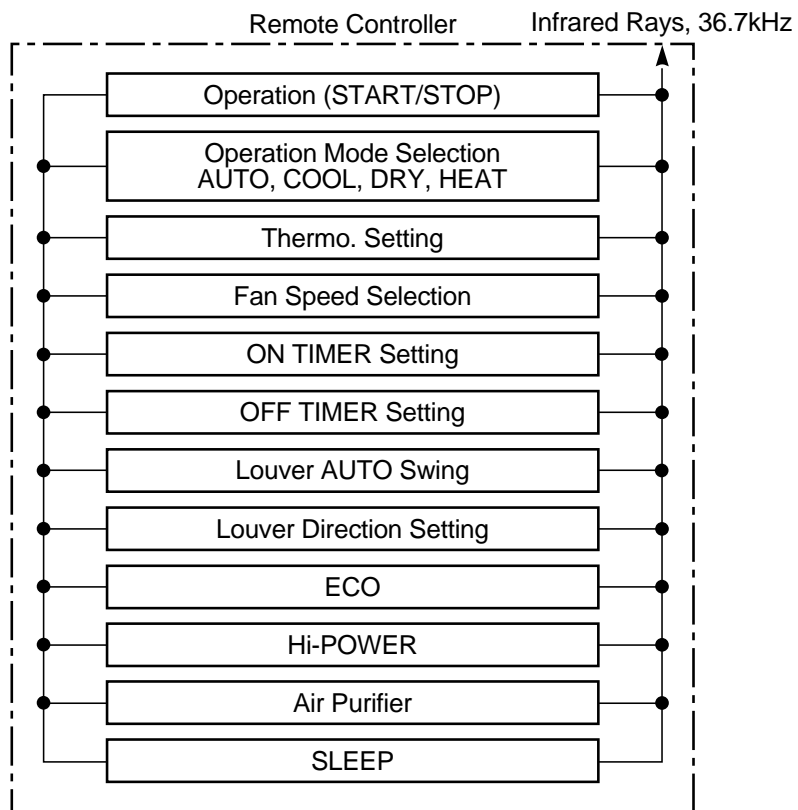

RAS-M10GKCVP-E, RAS-M13GKCVP-E, RAS-M16GKCVP-E

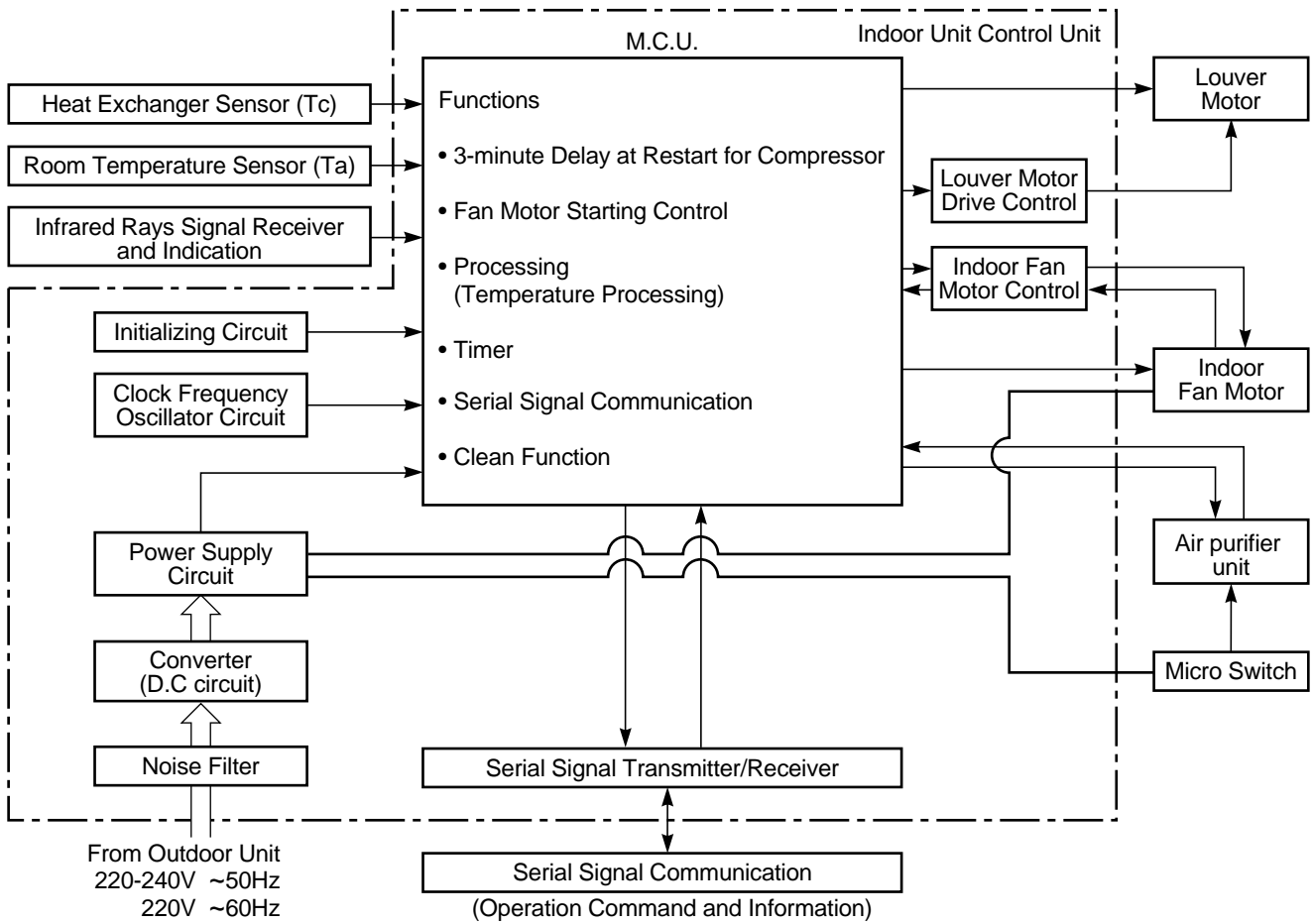

REMOTE CONTROLLER

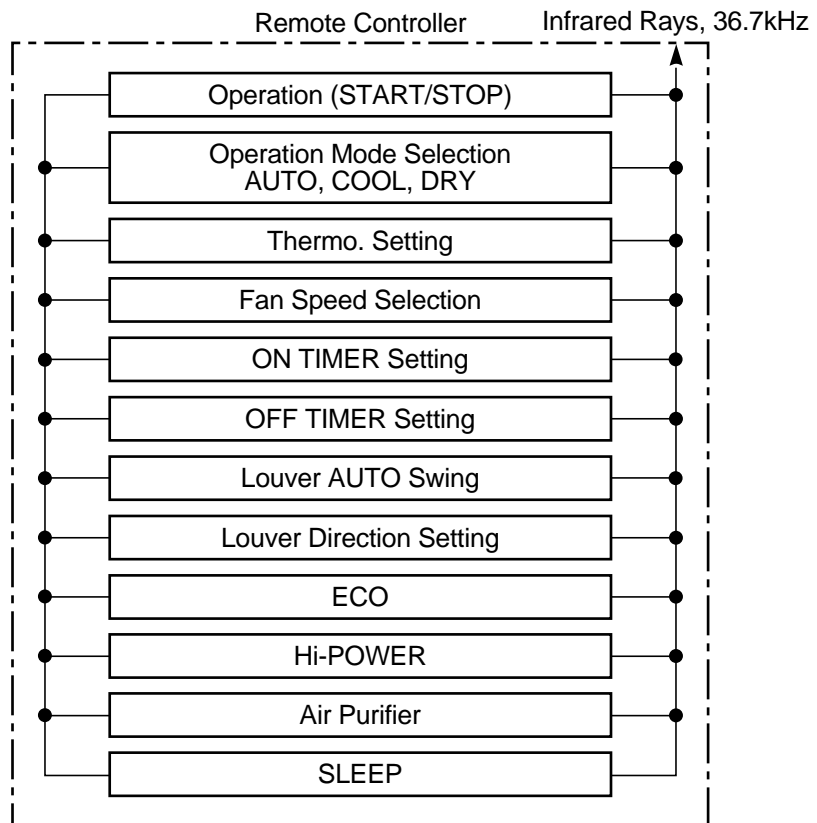

8-2. Outdoor Unit (Inverter Assembly)

RAS-4M27GAV-E, RAS-4M27GACV-E, RAS-3M26GAV-E

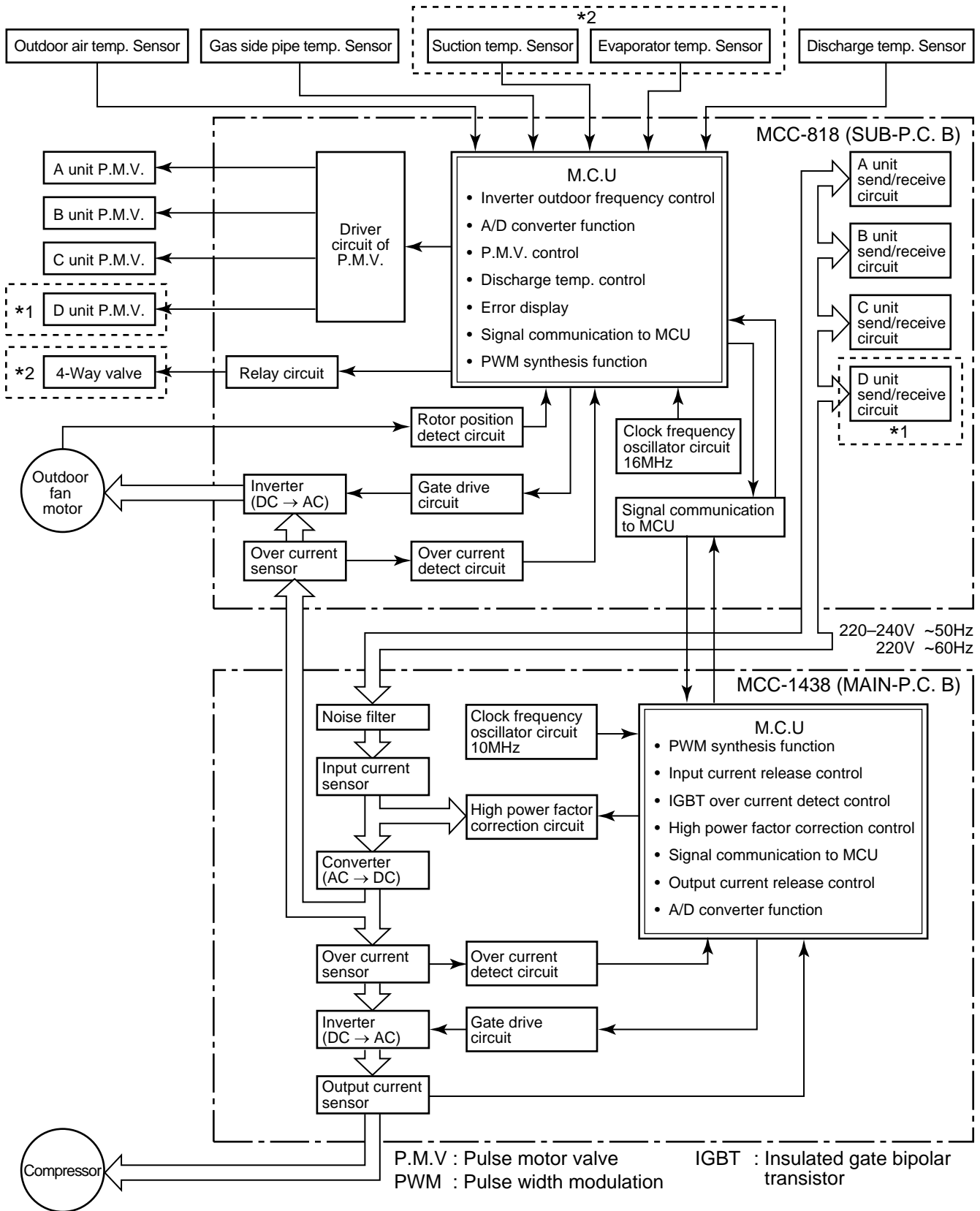

NOTE) *1 : 4 unit multi model only. *2 : Heat pump model only.

9. OPERATION DESCRIPTION

9-1. Outline of Air Conditioner Control

This air conditioner is a capacity-variable type air conditioner, which uses DC motor for the indoor fan motor and the outdoor fan motor. And the capacity-proportional control compressor which can change the motor speed in the range from 13 to 90 rps is mounted. The DC motor drive circuit is mounted to the indoor unit. The compressor and the inverter to control fan motor are mounted to the outdoor unit.

The entire air conditioner is mainly controlled by the indoor unit controller.

The indoor unit controller drives the indoor fan motor based upon command sent from the remote controller, and transfers the operation command to the outdoor unit controller.

The outdoor unit controller receives operation command from the indoor unit side, and controls the outdoor fan and the pulse motor valve. (P.M.V)

Besides, detecting revolution position of the compressor motor, the outdoor unit controller controls speed of the compressor motor by controlling output voltage of the inverter and switching timing of the supply power (current transfer timing) so that motors drive according to the operation command.

And then, the outdoor unit controller transfers reversely the operating status information of the outdoor unit to control the indoor unit controller.

As the compressor adopts four-pole brushless DC motor, the frequency of the supply power from inverter to compressor is two-times cycles of the actual number of revolution.

1. Role of indoor unit controller

The indoor unit controller judges the operation commands from the remote controller and assumes the following functions.

- Judgment of suction air temperature of the indoor heat exchanger by using the indoor temp. sensor. (TA sensor)
- Judgment of the indoor heat exchanger temperature by using heat exchanger sensor (TC sensor) (Prevent-freezing control, etc.)
- Louver motor control
- Indoor fan motor operation control
- LED (Light Emitting Diode) display control
- Transferring of operation command signal (Serial signal) to the outdoor unit
- Reception of information of operation status (Serial signal including outside temp. data) to the outdoor unit and judgment/display of error
- Air purifier operation control

2. Role of outdoor unit controller

Receiving the operation command signal (Serial signal) from the indoor unit controller, the outdoor unit performs its role.

- Compressor operation control
- Operation control of outdoor fan motor
- P.M.V. control
- 4-way valve control

} Operations followed to judgment of serial signal from indoor side.

- Detection of inverter input current and current release operation
- Over-current detection and prevention operation to IGBT module (Compressor stop function)
- Compressor and outdoor fan stop function when serial signal is off (when the serial signal does not reach the board assembly of outdoor control by trouble of the signal system)
- Transferring of operation information (Serial signal) from outdoor unit controller to indoor unit controller
- Detection of outdoor temperature and operation revolution control
- Defrost control in heating operation (Temp. measurement by outdoor heat exchanger and control for 4-way valve and outdoor fan)

3. Contents of operation command signal (Serial signal) from indoor unit controller to outdoor unit controller

The following three types of signals are sent from the indoor unit controller.

- Operation mode set on the remote controller
- Compressor revolution command signal defined by indoor temperature and set temperature (Correction along with variation of room temperature and correction of indoor heat exchanger temperature are added.)
- Temperature of indoor heat exchanger
- For these signals ([Operation mode] and [Compressor revolution] indoor heat exchanger temperature), the outdoor unit controller monitors the input current to the inverter, and performs the followed operation within the range that current does not exceed the allowable value.

4. Contents of operation command signal (Serial signal) from outdoor unit controller to indoor unit controller

The following signals are sent from the outdoor unit controller.

- The current operation mode
 - The current compressor revolution
 - Outdoor temperature
 - Existence of protective circuit operation
- For transferring of these signals, the indoor unit controller monitors the contents of signals, and judges existence of trouble occurrence. Contents of judgment are described below.
- Whether distinction of the current operation status meets to the operation command signal
 - Whether protective circuit operates

When no signal is received from the outdoor unit controller, it is assumed as a trouble.

9-2. Operation Description

9-2.	1. Basic operation	50
	1. Operation control	50
	2. Operating mode selection when performing 2-room operation	51
	3. Cooling/Heating operation	51
	4. AUTO operation	52
	5. DRY operation	52
	2. Indoor fan motor control	53
	<In cooling operation>	53
	<In heating operation>	54
	3. Outdoor fan motor control	55
	4. Capacity control	56
	5. Current release control	56
	6. Release protective control by temperature of indoor heat exchanger	57
	7. Winding/Coil heating control	58
	8. Defrost control (Only in heating operation)	58
	9. Louver control	59
	1) Louver position	59
	2) Air direction adjustment	59
	3) Swing	59
	10. ECO operation	60
	11. Temporary operation	61
	12. Air purifying control	61
	Air purifying control [Detection of abnormality]	62
	13. Discharge temperature control	62
	14. Pulse motor valve (P.M.V.) control	63
	15. Clean operation	64
	16. Clean operation release	65
	17. Select switch on remote controller	66
9-3.	Auto Restart Function	67
	9-3-1. How to Set the Auto Restart Function	67
	9-3-2. How to Cancel the Auto Restart Function	68
	9-3-3. Power Failure During Timer Operation	68
9-4.	FILTER Indicator	68
	9-4-1. How to Turn Off FILTER Indicator	68
9-5.	Remote Controller and Its Functions	69
	9-5-1. Parts Name of Remote Controller	69
	9-5-2. Name and Functions of Indications on Remote Controller	70
9-6.	Hi-POWER Mode	
	([Hi-POWER] button on the remote controller is pressed)	71
9-7.	Intermittent Operation Control for Indoor Fans of the Indoor Unit	
	at Thermo-off Side in Heating Operation	71

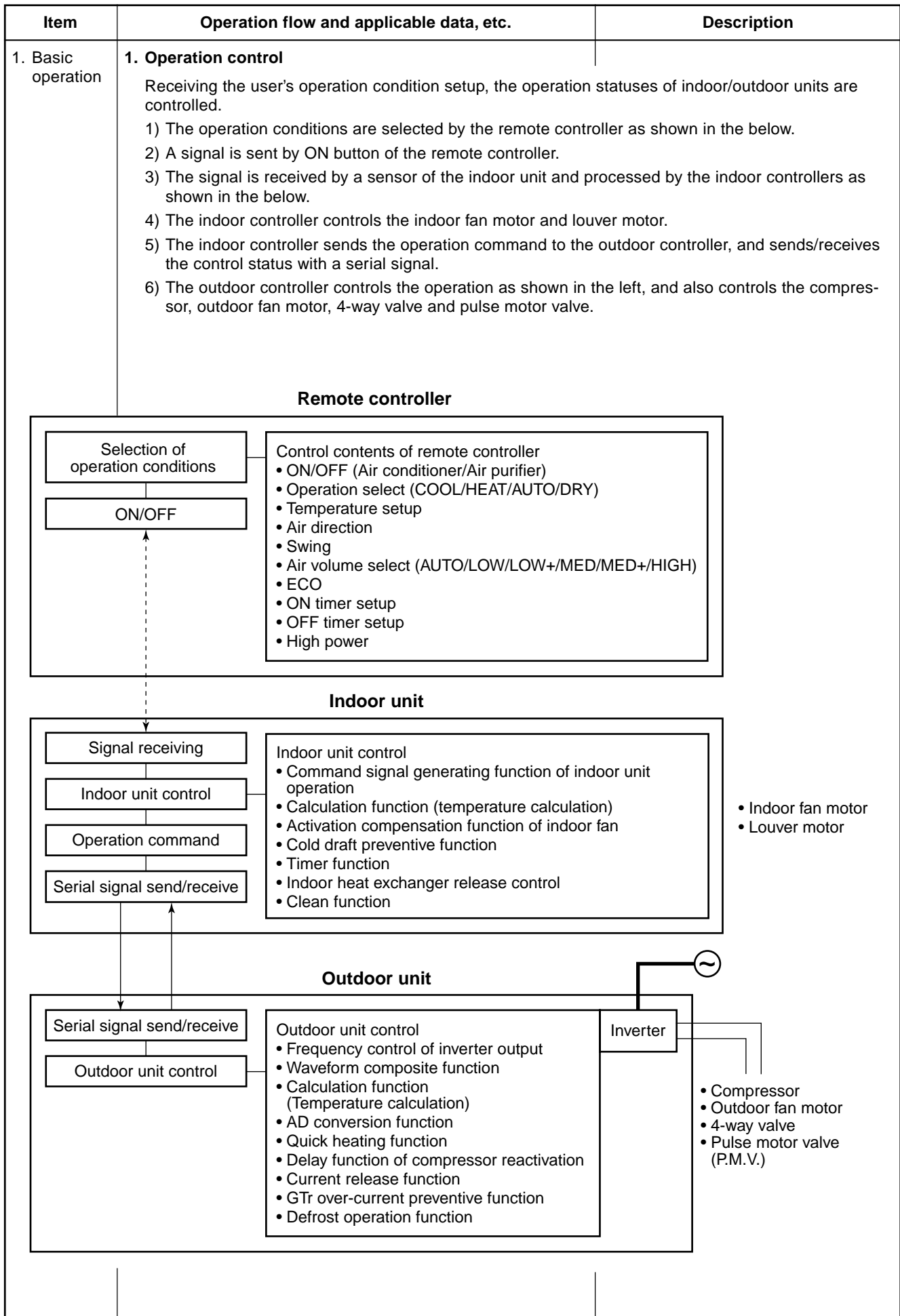

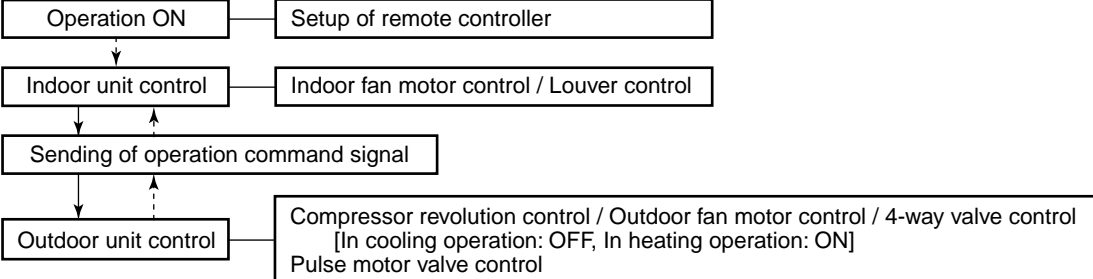
Item	Operation flow and applicable data, etc.	Description																																																																																																																																					
1. Basic operation	<p>2. Operating mode selection when performing 2-room operation</p> <p>1) The outdoor unit operating mode conforms to the instructions of the indoor unit that was pressed first.</p> <p>2) When combined operation consisting of cooling (dry) and heating, fan (air purification) and heating, or cleaning operation and heating is performed, operation conforms to the instructions of the indoor unit that was pressed first as shown in the following table.</p> <p>3) The indoor fan stops for the indoor unit that was pressed last and which instructions are ignored.</p> <p>4) When three or four indoor units are operated concurrently, the priority is also given to operating mode of the indoor unit which was pressed first as same as the case when two indoor units are operated concurrently.</p> <table border="1" data-bbox="331 495 1430 1406"> <thead> <tr> <th>No.</th> <th>Indoor unit</th> <th>Set operating mode</th> <th>Actual indoor unit operation</th> <th>Actual outdoor unit operation</th> </tr> </thead> <tbody> <tr> <td rowspan="2">1</td> <td>Pressed first</td> <td>Cooling (dry)</td> <td>Cooling (dry)</td> <td rowspan="2">Cooling</td> </tr> <tr> <td>Pressed last</td> <td>Cooling (dry)</td> <td>Cooling (dry)</td> </tr> <tr> <td rowspan="2">2</td> <td>Pressed first</td> <td>Heating</td> <td>Heating</td> <td rowspan="2">Heating</td> </tr> <tr> <td>Pressed last</td> <td>Heating</td> <td>Heating</td> </tr> <tr> <td rowspan="2">3</td> <td>Pressed first</td> <td>Fan (solo air purification)</td> <td>Fan (solo air purification)</td> <td rowspan="2">Stopped</td> </tr> <tr> <td>Pressed last</td> <td>Fan (solo air purification)</td> <td>Fan (solo air purification)</td> </tr> <tr> <td rowspan="2">4</td> <td>Pressed first</td> <td>Fan (solo air purification)</td> <td>Fan (solo air purification)</td> <td rowspan="2">Cooling</td> </tr> <tr> <td>Pressed last</td> <td>Cooling (dry)</td> <td>Cooling (dry)</td> </tr> <tr> <td rowspan="2">5</td> <td>Pressed first</td> <td>Cooling (dry)</td> <td>Cooling (dry)</td> <td rowspan="2">Cooling</td> </tr> <tr> <td>Pressed last</td> <td>Fan (solo air purification)</td> <td>Fan (solo air purification)</td> </tr> <tr> <td rowspan="2">6</td> <td>Pressed first</td> <td>Cooling (dry)</td> <td>Cooling (dry)</td> <td rowspan="2">Cooling</td> </tr> <tr> <td>Pressed last</td> <td>Heating</td> <td>Fan stopped</td> </tr> <tr> <td rowspan="2">7</td> <td>Pressed first</td> <td>Heating</td> <td>Heating</td> <td rowspan="2">Heating</td> </tr> <tr> <td>Pressed last</td> <td>Cooling (dry)</td> <td>Fan stopped</td> </tr> <tr> <td rowspan="2">8</td> <td>Pressed first</td> <td>Fan (solo air purification)</td> <td>Fan (solo air purification)</td> <td rowspan="2">Stopped</td> </tr> <tr> <td>Pressed last</td> <td>Heating</td> <td>Fan stopped</td> </tr> <tr> <td rowspan="2">9</td> <td>Pressed first</td> <td>Heating</td> <td>Heating</td> <td rowspan="2">Heating</td> </tr> <tr> <td>Pressed last</td> <td>Fan (solo air purification)</td> <td>Fan stopped</td> </tr> <tr> <td rowspan="2">10</td> <td>Pressed first</td> <td>Cleaning operation</td> <td>Cleaning operation</td> <td rowspan="2">Stopped</td> </tr> <tr> <td>Pressed last</td> <td>Cleaning operation</td> <td>Cleaning operation</td> </tr> <tr> <td rowspan="2">11</td> <td>Pressed first</td> <td>Cleaning operation</td> <td>Cleaning operation</td> <td rowspan="2">Cooling</td> </tr> <tr> <td>Pressed last</td> <td>Cooling (dry)</td> <td>Cooling (dry)</td> </tr> <tr> <td rowspan="2">12</td> <td>Pressed first</td> <td>Cooling (dry)</td> <td>Cooling (dry)</td> <td rowspan="2">Cooling</td> </tr> <tr> <td>Pressed last</td> <td>Cleaning operation</td> <td>Cleaning operation</td> </tr> <tr> <td rowspan="2">13</td> <td>Pressed first</td> <td>Cleaning operation</td> <td>Cleaning operation</td> <td rowspan="2">Stopped</td> </tr> <tr> <td>Pressed last</td> <td>Fan (solo air purification)</td> <td>Fan (solo air purification)</td> </tr> <tr> <td rowspan="2">14</td> <td>Pressed first</td> <td>Fan (solo air purification)</td> <td>Fan (solo air purification)</td> <td rowspan="2">Stopped</td> </tr> <tr> <td>Pressed last</td> <td>Cleaning operation</td> <td>Cleaning operation</td> </tr> <tr> <td rowspan="2">15</td> <td>Pressed first</td> <td>Cleaning operation</td> <td>Cleaning operation</td> <td rowspan="2">Stopped</td> </tr> <tr> <td>Pressed last</td> <td>Heating</td> <td>Fan stopped</td> </tr> <tr> <td rowspan="2">16</td> <td>Pressed first</td> <td>Heating</td> <td>Heating</td> <td rowspan="2">Heating</td> </tr> <tr> <td>Pressed last</td> <td>Cleaning operation</td> <td>Fan stopped</td> </tr> </tbody> </table>	No.	Indoor unit	Set operating mode	Actual indoor unit operation	Actual outdoor unit operation	1	Pressed first	Cooling (dry)	Cooling (dry)	Cooling	Pressed last	Cooling (dry)	Cooling (dry)	2	Pressed first	Heating	Heating	Heating	Pressed last	Heating	Heating	3	Pressed first	Fan (solo air purification)	Fan (solo air purification)	Stopped	Pressed last	Fan (solo air purification)	Fan (solo air purification)	4	Pressed first	Fan (solo air purification)	Fan (solo air purification)	Cooling	Pressed last	Cooling (dry)	Cooling (dry)	5	Pressed first	Cooling (dry)	Cooling (dry)	Cooling	Pressed last	Fan (solo air purification)	Fan (solo air purification)	6	Pressed first	Cooling (dry)	Cooling (dry)	Cooling	Pressed last	Heating	Fan stopped	7	Pressed first	Heating	Heating	Heating	Pressed last	Cooling (dry)	Fan stopped	8	Pressed first	Fan (solo air purification)	Fan (solo air purification)	Stopped	Pressed last	Heating	Fan stopped	9	Pressed first	Heating	Heating	Heating	Pressed last	Fan (solo air purification)	Fan stopped	10	Pressed first	Cleaning operation	Cleaning operation	Stopped	Pressed last	Cleaning operation	Cleaning operation	11	Pressed first	Cleaning operation	Cleaning operation	Cooling	Pressed last	Cooling (dry)	Cooling (dry)	12	Pressed first	Cooling (dry)	Cooling (dry)	Cooling	Pressed last	Cleaning operation	Cleaning operation	13	Pressed first	Cleaning operation	Cleaning operation	Stopped	Pressed last	Fan (solo air purification)	Fan (solo air purification)	14	Pressed first	Fan (solo air purification)	Fan (solo air purification)	Stopped	Pressed last	Cleaning operation	Cleaning operation	15	Pressed first	Cleaning operation	Cleaning operation	Stopped	Pressed last	Heating	Fan stopped	16	Pressed first	Heating	Heating	Heating	Pressed last	Cleaning operation	Fan stopped	
No.	Indoor unit	Set operating mode	Actual indoor unit operation	Actual outdoor unit operation																																																																																																																																			
1	Pressed first	Cooling (dry)	Cooling (dry)	Cooling																																																																																																																																			
	Pressed last	Cooling (dry)	Cooling (dry)																																																																																																																																				
2	Pressed first	Heating	Heating	Heating																																																																																																																																			
	Pressed last	Heating	Heating																																																																																																																																				
3	Pressed first	Fan (solo air purification)	Fan (solo air purification)	Stopped																																																																																																																																			
	Pressed last	Fan (solo air purification)	Fan (solo air purification)																																																																																																																																				
4	Pressed first	Fan (solo air purification)	Fan (solo air purification)	Cooling																																																																																																																																			
	Pressed last	Cooling (dry)	Cooling (dry)																																																																																																																																				
5	Pressed first	Cooling (dry)	Cooling (dry)	Cooling																																																																																																																																			
	Pressed last	Fan (solo air purification)	Fan (solo air purification)																																																																																																																																				
6	Pressed first	Cooling (dry)	Cooling (dry)	Cooling																																																																																																																																			
	Pressed last	Heating	Fan stopped																																																																																																																																				
7	Pressed first	Heating	Heating	Heating																																																																																																																																			
	Pressed last	Cooling (dry)	Fan stopped																																																																																																																																				
8	Pressed first	Fan (solo air purification)	Fan (solo air purification)	Stopped																																																																																																																																			
	Pressed last	Heating	Fan stopped																																																																																																																																				
9	Pressed first	Heating	Heating	Heating																																																																																																																																			
	Pressed last	Fan (solo air purification)	Fan stopped																																																																																																																																				
10	Pressed first	Cleaning operation	Cleaning operation	Stopped																																																																																																																																			
	Pressed last	Cleaning operation	Cleaning operation																																																																																																																																				
11	Pressed first	Cleaning operation	Cleaning operation	Cooling																																																																																																																																			
	Pressed last	Cooling (dry)	Cooling (dry)																																																																																																																																				
12	Pressed first	Cooling (dry)	Cooling (dry)	Cooling																																																																																																																																			
	Pressed last	Cleaning operation	Cleaning operation																																																																																																																																				
13	Pressed first	Cleaning operation	Cleaning operation	Stopped																																																																																																																																			
	Pressed last	Fan (solo air purification)	Fan (solo air purification)																																																																																																																																				
14	Pressed first	Fan (solo air purification)	Fan (solo air purification)	Stopped																																																																																																																																			
	Pressed last	Cleaning operation	Cleaning operation																																																																																																																																				
15	Pressed first	Cleaning operation	Cleaning operation	Stopped																																																																																																																																			
	Pressed last	Heating	Fan stopped																																																																																																																																				
16	Pressed first	Heating	Heating	Heating																																																																																																																																			
	Pressed last	Cleaning operation	Fan stopped																																																																																																																																				
	<p>3. Cooling/Heating operation</p> <p>The operations are performed in the following parts by controls according to cooling/heating conditions.</p> <p>1) Receiving the operation ON signal of the remote controller, the cooling or heating operation signal starts being transferred from the indoor controller to the outdoor unit.</p> <p>2) At the indoor unit side, the indoor fan is operated according to the contents of “2. Indoor fan motor control” and the louver according to the contents of “9. Louver control”, respectively.</p> <p>3) The outdoor unit controls the outdoor fan motor, compressor, pulse motor valve and 4-way valve according to the operation signal sent from the indoor unit.</p> <p>*1. The power coupler of 4-way valve is usually turned off, and it is turned on during defrost operation. (Only in heating)</p>  <pre> graph TD A[Operation ON] --> B[Indoor unit control] C[Setup of remote controller] --- B B --> D[Sending of operation command signal] D --> E[Outdoor unit control] E --> B E --- F["Compressor revolution control / Outdoor fan motor control / 4-way valve control [In cooling operation: OFF, In heating operation: ON] Pulse motor valve control"] </pre>																																																																																																																																						

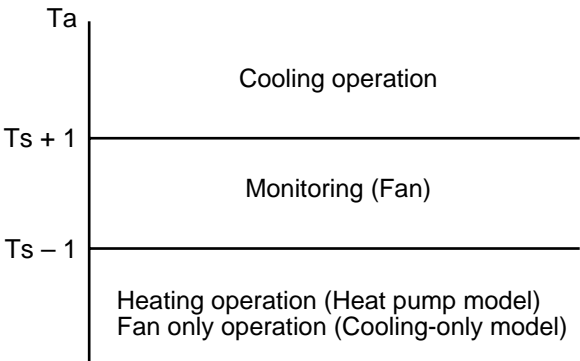
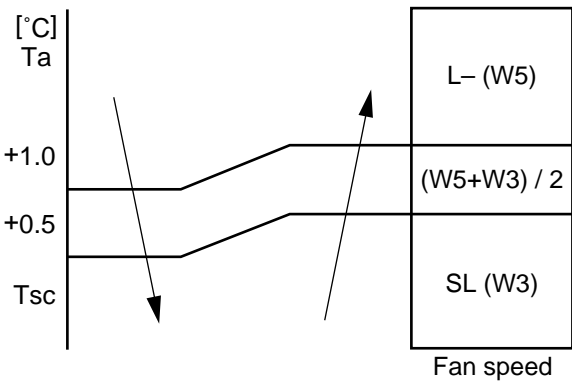
Item	Operation flow and applicable data, etc.	Description
<p>1. Basic operation</p>	<p>4. AUTO operation</p> <p>Selection of operation mode As shown in the following figure, the operation starts by selecting automatically the status of room temperature (Ta) when starting AUTO operation.</p>  <p>*1. When reselecting the operation mode, the fan speed is controlled by the previous operation mode.</p>	<ol style="list-style-type: none"> 1) Detects the room temperature (Ta) when the operation started. 2) Selects an operation mode from Ta in the left figure. 3) Fan operation continues until an operation mode is selected. 4) When AUTO operation has started within 2 hours after heating operation stopped and if the room temperature is 20°C or more, the fan operation is performed with "Super Ultra LOW" mode for 3 minutes. Then, select an operation mode. 5) If the status of compressor-OFF continues for 15 minutes the room temperature after selecting an operation mode (COOL/HEAT), reselect an operation mode.
	<p>5. DRY operation</p> <p>DRY operation is performed according to the difference between room temperature and the setup temperature as shown below.</p> <p>In DRY operation, fan speed is controlled in order to prevent lowering of the room temperature and to avoid air flow from blowing directly to persons.</p> 	<ol style="list-style-type: none"> 1) Detects the room temperature (Ta) when the DRY operation started. 2) Starts operation under conditions in the left figure according to the temperature difference between the room temperature and the setup temperature (Tsc). Setup temperature (Tsc) = Set temperature on remote controller (Ts) + (0.0 to 1.0) 3) When the room temperature is lower 1°C or less than the setup temperature, turn off the compressor.

Item	Operation flow and applicable data, etc.	Description																																																																																																																																																																																												
<p>2. Indoor fan motor control</p>	<p><In cooling operation> (This operation controls the fan speed at indoor unit side.) The indoor fan (cross flow fan) is operated by the phase-control induction motor. The fan rotates in 5 stages in MANUAL mode, and in 5 stages in AUTO mode, respectively. (Table 1)</p> <div style="display: flex; justify-content: space-around;"> <div data-bbox="167 448 383 974"> </div> <div data-bbox="470 638 1005 896"> <table border="1"> <thead> <tr> <th>Indication</th> <th>Fan speed</th> </tr> </thead> <tbody> <tr> <td>L </td> <td>W6</td> </tr> <tr> <td>L+ </td> <td>(L + M) / 2</td> </tr> <tr> <td>M </td> <td>W9</td> </tr> <tr> <td>M+ </td> <td>(M + H) / 2</td> </tr> <tr> <td>H </td> <td>WC</td> </tr> </tbody> </table> </div> </div> <p style="text-align: right;">(Fig. 1)</p> <p style="text-align: center;">(Fig. 2)</p> <div data-bbox="167 974 1005 1400"> <table border="1" style="margin-left: auto; margin-right: auto;"> <thead> <tr> <th colspan="2">Air volume AUTO</th> </tr> </thead> <tbody> <tr> <td>M+(WB)</td> <td>*3</td> </tr> <tr> <td></td> <td>*4</td> </tr> <tr> <td></td> <td>*5</td> </tr> <tr> <td>L(W6)</td> <td>(Linear approximation from M+ and L)</td> </tr> </tbody> </table> <p>*3 : Fan speed = (M + -L) x 3/4 + L *4 : Fan speed = (M + -L) x 2/4 + L *5 : Fan speed = (M + -L) x 1/4 + L</p> </div> <p style="text-align: center;">(Table 1) Indoor fan air flow rate</p> <table border="1" style="width: 100%; border-collapse: collapse;"> <thead> <tr> <th rowspan="2">Fan speed level</th> <th rowspan="2">COOL FAN ONLY</th> <th rowspan="2">HEAT</th> <th rowspan="2">DRY</th> <th colspan="2">RAS-B10GKVP-E RAS-M10GKCV-P-E</th> <th colspan="2">RAS-B13GKVP-E RAS-M13GKCV-P-E</th> <th colspan="2">RAS-B16GKVP-E RAS-M16GKCV-P-E</th> </tr> <tr> <th>Fan speed (rpm)</th> <th>Air flow rate (m³/h)</th> <th>Fan speed (rpm)</th> <th>Air flow rate (m³/h)</th> <th>Fan speed (rpm)</th> <th>Air flow rate (m³/h)</th> </tr> </thead> <tbody> <tr><td>WF</td><td></td><td>UH</td><td></td><td>1630</td><td>684</td><td>1650</td><td>694</td><td>1650</td><td>694</td></tr> <tr><td>WE</td><td></td><td>H</td><td></td><td>1480</td><td>609</td><td>1530</td><td>634</td><td>1580</td><td>659</td></tr> <tr><td>WD</td><td>UH</td><td>M+</td><td></td><td>1400</td><td>569</td><td>1440</td><td>589</td><td>1550</td><td>644</td></tr> <tr><td>WC</td><td>H</td><td></td><td></td><td>1350</td><td>544</td><td>1390</td><td>564</td><td>1530</td><td>634</td></tr> <tr><td>WB</td><td>M+</td><td></td><td></td><td>1200</td><td>468</td><td>1240</td><td>488</td><td>1380</td><td>559</td></tr> <tr><td>WA</td><td></td><td>M</td><td></td><td>1110</td><td>423</td><td>1150</td><td>443</td><td>1230</td><td>483</td></tr> <tr><td>W9</td><td>M</td><td>L+</td><td></td><td>980</td><td>358</td><td>1010</td><td>373</td><td>1080</td><td>408</td></tr> <tr><td>W8</td><td></td><td>L</td><td></td><td>910</td><td>323</td><td>910</td><td>323</td><td>970</td><td>353</td></tr> <tr><td>W7</td><td>L+</td><td>L-</td><td>L+</td><td>900</td><td>318</td><td>900</td><td>318</td><td>960</td><td>348</td></tr> <tr><td>W6</td><td>L</td><td></td><td>L</td><td>890</td><td>313</td><td>890</td><td>313</td><td>950</td><td>343</td></tr> <tr><td>W5</td><td>L-</td><td>UL</td><td>L-</td><td>880</td><td>308</td><td>880</td><td>308</td><td>940</td><td>338</td></tr> <tr><td>W4</td><td>UL</td><td></td><td>UL</td><td>730</td><td>232</td><td>730</td><td>232</td><td>790</td><td>263</td></tr> <tr><td>W3</td><td>SUL</td><td></td><td>SUL</td><td>580</td><td>157</td><td>580</td><td>157</td><td>640</td><td>187</td></tr> <tr><td>W2</td><td></td><td>SUL</td><td></td><td>430</td><td>82</td><td>430</td><td>82</td><td>490</td><td>112</td></tr> <tr><td>W1</td><td></td><td></td><td></td><td>400</td><td>67</td><td>400</td><td>67</td><td>400</td><td>67</td></tr> </tbody> </table>	Indication	Fan speed	L	W6	L+	(L + M) / 2	M	W9	M+	(M + H) / 2	H	WC	Air volume AUTO		M+(WB)	*3		*4		*5	L(W6)	(Linear approximation from M+ and L)	Fan speed level	COOL FAN ONLY	HEAT	DRY	RAS-B10GKVP-E RAS-M10GKCV-P-E		RAS-B13GKVP-E RAS-M13GKCV-P-E		RAS-B16GKVP-E RAS-M16GKCV-P-E		Fan speed (rpm)	Air flow rate (m³/h)	Fan speed (rpm)	Air flow rate (m³/h)	Fan speed (rpm)	Air flow rate (m³/h)	WF		UH		1630	684	1650	694	1650	694	WE		H		1480	609	1530	634	1580	659	WD	UH	M+		1400	569	1440	589	1550	644	WC	H			1350	544	1390	564	1530	634	WB	M+			1200	468	1240	488	1380	559	WA		M		1110	423	1150	443	1230	483	W9	M	L+		980	358	1010	373	1080	408	W8		L		910	323	910	323	970	353	W7	L+	L-	L+	900	318	900	318	960	348	W6	L		L	890	313	890	313	950	343	W5	L-	UL	L-	880	308	880	308	940	338	W4	UL		UL	730	232	730	232	790	263	W3	SUL		SUL	580	157	580	157	640	187	W2		SUL		430	82	430	82	490	112	W1				400	67	400	67	400	67	<div style="border: 1px solid black; padding: 5px; margin-bottom: 10px;"> <p>* Symbols</p> <p>UH : Ultra High H : High M+ : Medium+ M : Medium L+ : Low+ L : Low L- : Low- UL : Ultra Low SUL : Super Ultra Low</p> </div> <p>* The fan speed broadly varies due to position of the louver, etc. The described value indicates one under condition of inclining downward blowing.</p> <p>1) When setting the fan speed to L, L+, M, M+ or H on the remote controller, the operation is performed with the constant speed shown in Fig. 1.</p> <p>2) When setting the fan speed to AUTO on the remote controller, revolution of the fan motor is controlled to the fan speed level shown in Fig. 2 and Table 1 according to the setup temperature, room temperature, and heat exchanger temperature.</p>
Indication	Fan speed																																																																																																																																																																																													
L	W6																																																																																																																																																																																													
L+	(L + M) / 2																																																																																																																																																																																													
M	W9																																																																																																																																																																																													
M+	(M + H) / 2																																																																																																																																																																																													
H	WC																																																																																																																																																																																													
Air volume AUTO																																																																																																																																																																																														
M+(WB)	*3																																																																																																																																																																																													
	*4																																																																																																																																																																																													
	*5																																																																																																																																																																																													
L(W6)	(Linear approximation from M+ and L)																																																																																																																																																																																													
Fan speed level	COOL FAN ONLY	HEAT	DRY	RAS-B10GKVP-E RAS-M10GKCV-P-E		RAS-B13GKVP-E RAS-M13GKCV-P-E		RAS-B16GKVP-E RAS-M16GKCV-P-E																																																																																																																																																																																						
				Fan speed (rpm)	Air flow rate (m³/h)	Fan speed (rpm)	Air flow rate (m³/h)	Fan speed (rpm)	Air flow rate (m³/h)																																																																																																																																																																																					
WF		UH		1630	684	1650	694	1650	694																																																																																																																																																																																					
WE		H		1480	609	1530	634	1580	659																																																																																																																																																																																					
WD	UH	M+		1400	569	1440	589	1550	644																																																																																																																																																																																					
WC	H			1350	544	1390	564	1530	634																																																																																																																																																																																					
WB	M+			1200	468	1240	488	1380	559																																																																																																																																																																																					
WA		M		1110	423	1150	443	1230	483																																																																																																																																																																																					
W9	M	L+		980	358	1010	373	1080	408																																																																																																																																																																																					
W8		L		910	323	910	323	970	353																																																																																																																																																																																					
W7	L+	L-	L+	900	318	900	318	960	348																																																																																																																																																																																					
W6	L		L	890	313	890	313	950	343																																																																																																																																																																																					
W5	L-	UL	L-	880	308	880	308	940	338																																																																																																																																																																																					
W4	UL		UL	730	232	730	232	790	263																																																																																																																																																																																					
W3	SUL		SUL	580	157	580	157	640	187																																																																																																																																																																																					
W2		SUL		430	82	430	82	490	112																																																																																																																																																																																					
W1				400	67	400	67	400	67																																																																																																																																																																																					



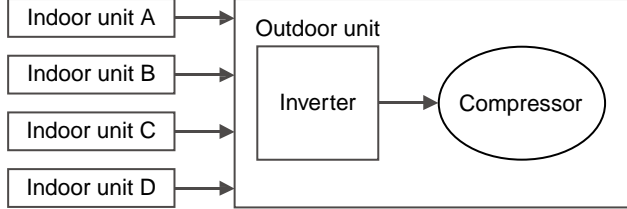
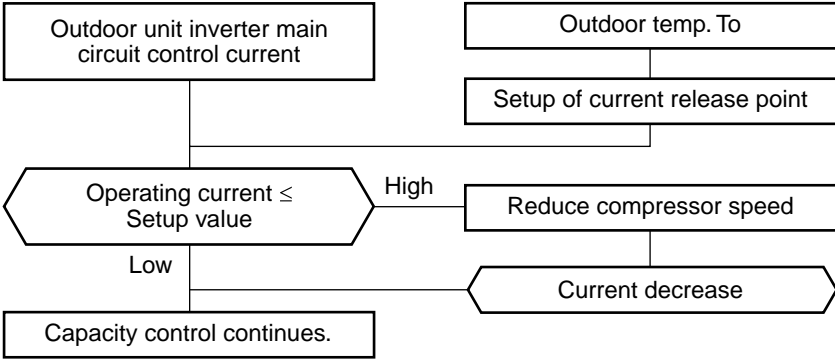

Item	Operation flow and applicable data, etc.	Description												
<p>2. Indoor fan motor control</p>	<p><In heating operation> (Heat pump model)</p> <p>(Fig. 3)</p> <table border="1" data-bbox="497 504 986 728"> <thead> <tr> <th>Indication</th> <th>Fan speed</th> </tr> </thead> <tbody> <tr> <td>L</td> <td>W8</td> </tr> <tr> <td>L+</td> <td>(L + M) / 2</td> </tr> <tr> <td>M</td> <td>WA</td> </tr> <tr> <td>M+</td> <td>(M + H) / 2</td> </tr> <tr> <td>H</td> <td>WE</td> </tr> </tbody> </table> <p>(Fig. 4)</p> <p>* Fan speed = $(TC - (42 + a)) / 10 \times (WD - W8) + W8$ a : In up operation 1, in down operation 0</p> <p>(Fig. 5)</p> <p>(Fig. 6)</p> <p>Cold draft preventive control</p>	Indication	Fan speed	L	W8	L+	(L + M) / 2	M	WA	M+	(M + H) / 2	H	WE	<ol style="list-style-type: none"> 1) When setting the fan speed to L, L+, M, M+ or H on the remote controller, the operation is performed with the constant speed shown in Fig. 3 and Table 1. 2) When setting the fan speed to AUTO on the remote controller, revolution of the fan motor is controlled to the fan speed level shown in Fig. 5 according to the set temperature and room temperature. 3) Min air flow rate is controlled by temperature of the indoor heat exchanger (Tc) as shown in Fig. 4. 4) Cold draft prevention, the fan speed is controlled by temperature of the indoor heat exchanger (Tc) as shown in Fig. 6.
Indication	Fan speed													
L	W8													
L+	(L + M) / 2													
M	WA													
M+	(M + H) / 2													
H	WE													

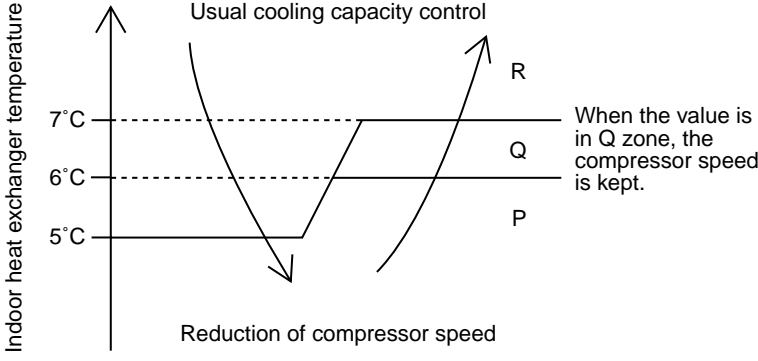
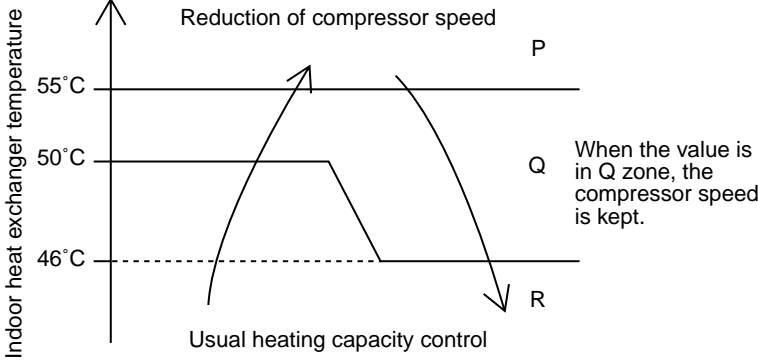
Item	Operation flow and applicable data, etc.	Description																																						
<p>3. Outdoor fan motor control</p>	<p>The blowing air volume at the outdoor unit side is controlled. Receiving the operation command from the controller of indoor unit, the controller of outdoor unit controls fan speed.</p> <p>* For the fan motor, a DC motor with non-stage variable speed system is used. However, it is limited to 8 stages for reasons of controlling.</p>	<p>1) The operation command sent from the remote controller is processed by the indoor unit controller and transferred to the controller of the outdoor unit.</p> <p>2) When strong wind blows at outdoor side, the operation of air conditioner continues with the fan motor stopped.</p> <p>3) Whether the fan is locked or not is detected, and the operation of air conditioner stops and an alarm is displayed if the fan is locked.</p> <p>4) According to each operation mode, by the conditions of outdoor temperature (To) and compressor revolution, the speed of the outdoor fan shown in the table is selected.</p>																																						
<p>Cooling operation, dry operation</p>																																								
<table border="1"> <thead> <tr> <th colspan="2">Compressor revolution (rps)</th> <th>20.3</th> <th>~50.3</th> <th>~62.8</th> <th>63.4~</th> </tr> </thead> <tbody> <tr> <td rowspan="3">Outdoor temp. sensor TO</td> <td>TO ≥ 38°C</td> <td>390 (rpm)</td> <td>670 (rpm)</td> <td>670 (rpm)</td> <td>740 (rpm)</td> </tr> <tr> <td rowspan="2">TO < 38°C</td> <td>1 to 2 units</td> <td>390 (rpm)</td> <td>510 (rpm)</td> <td>670 (rpm)</td> </tr> <tr> <td>1 to 2 units</td> <td>390 (rpm)</td> <td>510 (rpm)</td> <td>670 (rpm)</td> </tr> <tr> <td rowspan="2">Econo operation</td> <td>TO ≥ 38°C</td> <td>390 (rpm)</td> <td>510 (rpm)</td> <td>670 (rpm)</td> <td>670 (rpm)</td> </tr> <tr> <td>TO < 38°C</td> <td>390 (rpm)</td> <td>390 (rpm)</td> <td>510 (rpm)</td> <td>510 (rpm)</td> </tr> <tr> <td colspan="2">TO is abnormal</td> <td>510 (rpm)</td> <td>510 (rpm)</td> <td>670 (rpm)</td> <td>670 (rpm)</td> </tr> </tbody> </table>			Compressor revolution (rps)		20.3	~50.3	~62.8	63.4~	Outdoor temp. sensor TO	TO ≥ 38°C	390 (rpm)	670 (rpm)	670 (rpm)	740 (rpm)	TO < 38°C	1 to 2 units	390 (rpm)	510 (rpm)	670 (rpm)	1 to 2 units	390 (rpm)	510 (rpm)	670 (rpm)	Econo operation	TO ≥ 38°C	390 (rpm)	510 (rpm)	670 (rpm)	670 (rpm)	TO < 38°C	390 (rpm)	390 (rpm)	510 (rpm)	510 (rpm)	TO is abnormal		510 (rpm)	510 (rpm)	670 (rpm)	670 (rpm)
Compressor revolution (rps)		20.3	~50.3	~62.8	63.4~																																			
Outdoor temp. sensor TO	TO ≥ 38°C	390 (rpm)	670 (rpm)	670 (rpm)	740 (rpm)																																			
	TO < 38°C	1 to 2 units	390 (rpm)	510 (rpm)	670 (rpm)																																			
		1 to 2 units	390 (rpm)	510 (rpm)	670 (rpm)																																			
Econo operation	TO ≥ 38°C	390 (rpm)	510 (rpm)	670 (rpm)	670 (rpm)																																			
	TO < 38°C	390 (rpm)	390 (rpm)	510 (rpm)	510 (rpm)																																			
TO is abnormal		510 (rpm)	510 (rpm)	670 (rpm)	670 (rpm)																																			
<p>TO : Outdoor temp. sensor</p>																																								
<p>Heating operation</p>																																								
<table border="1"> <thead> <tr> <th colspan="2">Compressor revolution (rps)</th> <th>20.3</th> <th>~33.3</th> <th>~33.9</th> </tr> </thead> <tbody> <tr> <td rowspan="2">Outdoor temp. sensor TO</td> <td>TO ≥ 5°C</td> <td>390 (rpm)</td> <td>510 (rpm)</td> <td>670 (rpm)</td> </tr> <tr> <td>TO < 5°C</td> <td>510 (rpm)</td> <td>510 (rpm)</td> <td>740 (rpm)</td> </tr> <tr> <td rowspan="2">Econo operation</td> <td>TO ≥ 5°C</td> <td>390 (rpm)</td> <td>390 (rpm)</td> <td>510 (rpm)</td> </tr> <tr> <td>TO < 5°C</td> <td>390 (rpm)</td> <td>510 (rpm)</td> <td>510 (rpm)</td> </tr> <tr> <td colspan="2">TO is abnormal</td> <td>390 (rpm)</td> <td>510 (rpm)</td> <td>670 (rpm)</td> </tr> </tbody> </table>			Compressor revolution (rps)		20.3	~33.3	~33.9	Outdoor temp. sensor TO	TO ≥ 5°C	390 (rpm)	510 (rpm)	670 (rpm)	TO < 5°C	510 (rpm)	510 (rpm)	740 (rpm)	Econo operation	TO ≥ 5°C	390 (rpm)	390 (rpm)	510 (rpm)	TO < 5°C	390 (rpm)	510 (rpm)	510 (rpm)	TO is abnormal		390 (rpm)	510 (rpm)	670 (rpm)										
Compressor revolution (rps)		20.3	~33.3	~33.9																																				
Outdoor temp. sensor TO	TO ≥ 5°C	390 (rpm)	510 (rpm)	670 (rpm)																																				
	TO < 5°C	510 (rpm)	510 (rpm)	740 (rpm)																																				
Econo operation	TO ≥ 5°C	390 (rpm)	390 (rpm)	510 (rpm)																																				
	TO < 5°C	390 (rpm)	510 (rpm)	510 (rpm)																																				
TO is abnormal		390 (rpm)	510 (rpm)	670 (rpm)																																				
<p>TO : Outdoor temp. sensor</p>																																								

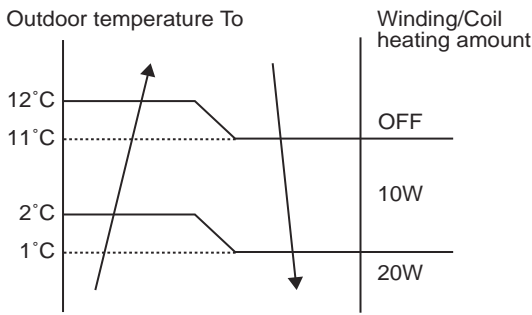
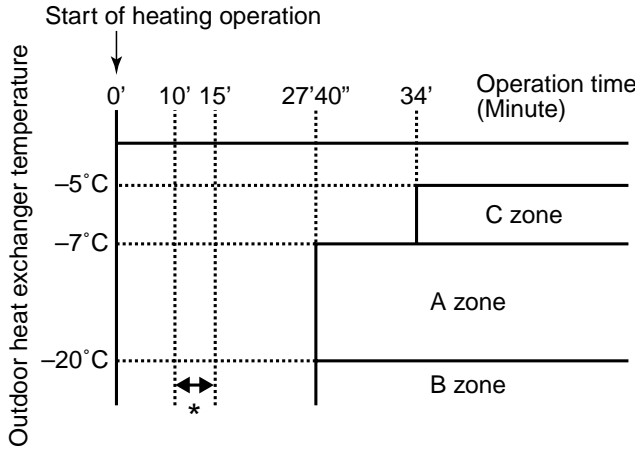
Item	Operation flow and applicable data, etc.	Description																																										
4. Capacity control	<p>1) Four indoor units from A to D determine the respective instruction revolutions from the difference between the remote controller setting temperature (Ts) and the indoor temperature (Ta), and transmit this to the outdoor unit.</p> <p>2) The outdoor unit receives the instructions from the indoor units, and the inverter operates the compressor at the calculated revolutions.</p> <p>3) The compressor operation range in each operating mode is shown in the left table.</p> 																																											
<table border="1"> <thead> <tr> <th>Operation mode</th> <th>No. of operating unit</th> <th>Combination of indoor units</th> <th>Compressor revolution (rps)</th> </tr> </thead> <tbody> <tr> <td rowspan="6">COOL</td> <td rowspan="3">1 unit</td> <td>M10</td> <td>20 to 28</td> </tr> <tr> <td>M13</td> <td>20 to 43</td> </tr> <tr> <td>M16</td> <td>20 to 53</td> </tr> <tr> <td>2 units</td> <td>○ *</td> <td>20 to 66</td> </tr> <tr> <td>3 units</td> <td>○ *</td> <td>31 to 69</td> </tr> <tr> <td>4 units</td> <td>○ *</td> <td>31 to 69</td> </tr> </tbody> </table>	Operation mode	No. of operating unit	Combination of indoor units	Compressor revolution (rps)	COOL	1 unit	M10	20 to 28	M13	20 to 43	M16	20 to 53	2 units	○ *	20 to 66	3 units	○ *	31 to 69	4 units	○ *	31 to 69	<table border="1"> <thead> <tr> <th>Operation mode</th> <th>No. of operating unit</th> <th>Combination of indoor units</th> <th>Compressor revolution (rps)</th> </tr> </thead> <tbody> <tr> <td rowspan="6">HEAT</td> <td rowspan="3">1 unit</td> <td>M10</td> <td>15 to 52</td> </tr> <tr> <td>M13</td> <td>15 to 63</td> </tr> <tr> <td>M16</td> <td>15 to 67</td> </tr> <tr> <td>2 units</td> <td>○ *</td> <td>15 to 90</td> </tr> <tr> <td>3 units</td> <td>○ *</td> <td>17 to 90</td> </tr> <tr> <td>4 units</td> <td>○ *</td> <td>22 to 90</td> </tr> </tbody> </table>	Operation mode	No. of operating unit	Combination of indoor units	Compressor revolution (rps)	HEAT	1 unit	M10	15 to 52	M13	15 to 63	M16	15 to 67	2 units	○ *	15 to 90	3 units	○ *	17 to 90	4 units	○ *	22 to 90	
Operation mode	No. of operating unit	Combination of indoor units	Compressor revolution (rps)																																									
COOL	1 unit	M10	20 to 28																																									
		M13	20 to 43																																									
		M16	20 to 53																																									
	2 units	○ *	20 to 66																																									
	3 units	○ *	31 to 69																																									
	4 units	○ *	31 to 69																																									
Operation mode	No. of operating unit	Combination of indoor units	Compressor revolution (rps)																																									
HEAT	1 unit	M10	15 to 52																																									
		M13	15 to 63																																									
		M16	15 to 67																																									
	2 units	○ *	15 to 90																																									
	3 units	○ *	17 to 90																																									
	4 units	○ *	22 to 90																																									
* : In case that any multiple indoor units are combined.																																												
5. Current release control	<p>This function prevents troubles on the electronic parts of the compressor driving inverter.</p> <p>This function also controls drive circuit of the compressor speed so that electric power of the compressor drive circuit does not exceed the specified value.</p>  <table border="1" data-bbox="172 1727 1011 2047"> <thead> <tr> <th>Outdoor temp.</th> <th>Cooling current release value</th> <th>Heating current release value</th> </tr> </thead> <tbody> <tr> <td>40°C</td> <td rowspan="2">9.6A</td> <td rowspan="2">14.4A</td> </tr> <tr> <td>16°C</td> </tr> <tr> <td>11°C</td> <td rowspan="3">14.2A</td> <td>14.4A</td> </tr> <tr> <td>10.5°C</td> <td>14.5A</td> </tr> <tr> <td></td> <td></td> </tr> </tbody> </table>	Outdoor temp.	Cooling current release value	Heating current release value	40°C	9.6A	14.4A	16°C	11°C	14.2A	14.4A	10.5°C	14.5A			<p>1) The input current of the outdoor unit is detected in the inverter section of the outdoor unit.</p> <p>2) According to the detected outdoor temperature, the specified value of the current is selected.</p> <p>3) Whether the current value exceeds the specified value or not is judged.</p> <p>4) If the current value exceeds the specified value, this function reduces the compressor speed and controls speed up to the closest one commanded from the indoor unit within the range which does not exceed the specified value.</p>																												
Outdoor temp.	Cooling current release value	Heating current release value																																										
40°C	9.6A	14.4A																																										
16°C																																												
11°C	14.2A	14.4A																																										
10.5°C		14.5A																																										

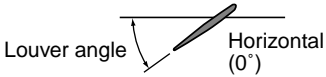
Item	Operation flow and applicable data, etc.	Description
<p>6. Release protective control by temperature of indoor heat exchanger</p>	<p><In cooling/dry operation> (Prevent-freezing control for indoor heat exchanger) In cooling/dry operation, the sensor of indoor heat exchanger detects evaporation temperature and controls the compressor speed so that temperature of the heat exchanger does not exceed the specified value.</p> 	<ol style="list-style-type: none"> 1) When temperature of the indoor heat exchanger drops below 5°C, the compressor speed is reduced. (P zone) 2) When temperature of the indoor heat exchanger rises in the range from 6°C to under 7°C, the compressor speed is kept. (Q zone) 3) When temperature of the indoor heat exchanger rises to 7°C or higher, the capacity control operation returns to the usual control in cooling operation. (R zone)
	<p><In heating operation> (Prevent-overpressure control for refrigerating cycle) In heating operation, the sensor of indoor heat exchanger detects condensation temperature and controls the compressor speed so that temperature of the heat exchanger does not exceed the specified value.</p> 	<ol style="list-style-type: none"> 1) When temperature of the indoor heat exchanger rises in the range from 50°C to 55°C, the compressor speed is kept. (Q zone) When temperature of the indoor heat exchanger drops in the range from 46°C to under 55°C, the compressor speed is kept. (Q zone) 2) When temperature of the indoor heat exchanger rises to 55°C or higher, the compressor speed is reduced. (P zone) 3) When temperature of the indoor heat exchanger does not rise to 50°C, or when it drops below to 46°C, the capacity control operation returns to the usual control in heating operation. (R zone)

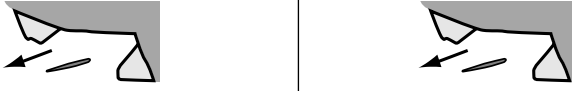
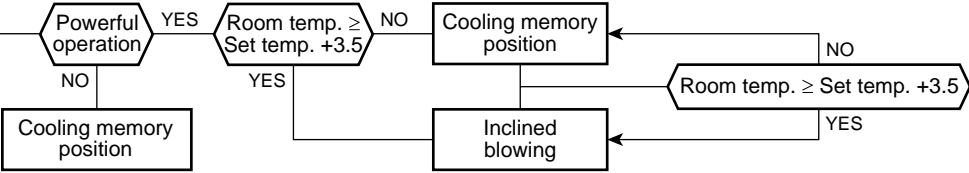
Item	Operation flow and applicable data, etc.	Description						
7. Winding/Coil heating control	<p>When the outdoor temperature is low, the windings/coils are heated to ensure compressor reliability.</p> 	<p>Winding/Coil heating is performed when the following conditions are met.</p> <p>Condition 1 : When the discharge sensor temperature (Td) is less than 30°C.</p> <p>Condition 2 : When 2 hours or more have elapsed after cooling, dry or heating operation stops.</p> <p>Condition 3 : When the outdoor sensor temperature (To) is as shown in the left figure.</p>						
8. Defrost control (Only in heating operation)	<p>(This function removes frost adhered to the outdoor heat exchanger.)</p> <p>The temperature sensor of the outdoor heat exchanger (Te sensor) judges the frosting status of the outdoor heat exchanger and the defrost operation is performed with 4-way valve reverse defrost system.</p>  <p>* The minimum value of Te sensor 10 to 15 minutes after start of operation is stored in memory as Te0.</p> <p style="text-align: center;">Table 1</p> <table border="1" data-bbox="167 1668 933 1870"> <tr> <td>A zone</td> <td>When $Te_0 - TE \geq 2.5$ continued for 2 minutes in A zone, defrost operation starts.</td> </tr> <tr> <td>B zone</td> <td>When the operation continued for 2 minutes in B zone, defrost operation starts.</td> </tr> <tr> <td>C zone</td> <td>When $Te_0 - TE \geq 3$ continued for 2 minutes in C zone, defrost operation starts.</td> </tr> </table>	A zone	When $Te_0 - TE \geq 2.5$ continued for 2 minutes in A zone, defrost operation starts.	B zone	When the operation continued for 2 minutes in B zone, defrost operation starts.	C zone	When $Te_0 - TE \geq 3$ continued for 2 minutes in C zone, defrost operation starts.	<p>The necessity of defrost operation is detected by the outdoor heat exchanger temperature. The conditions to detect the necessity of defrost operation differ in A, B, or C zone each. (Table 1)</p> <p><Defrost operation></p> <ul style="list-style-type: none"> Defrost operation in A to C zones <ol style="list-style-type: none"> Stop operation of the compressor for 20 seconds. Invert (OFF) 4-way valve 10 seconds after stop of the compressor. The outdoor fan stops at the same time when the compressor stops. When temperature of the indoor heat exchanger becomes 38°C or lower, stop the indoor fan. <p><Finish of defrost operation></p> <ul style="list-style-type: none"> Returning conditions from defrost operation to heating operation <ol style="list-style-type: none"> Temperature of outdoor heat exchanger rises to +8°C or higher. Temperature of outdoor heat exchanger is kept at +5°C or higher for 80 seconds. Defrost operation continues for 15 minutes. <p><Returning from defrost operation></p> <ol style="list-style-type: none"> Stop operation of the compressor for approx. 50 seconds. Invert (ON) 4-way valve approx. 40 seconds after stop of the compressor. The outdoor fan starts rotating at the same time when the compressor starts.
A zone	When $Te_0 - TE \geq 2.5$ continued for 2 minutes in A zone, defrost operation starts.							
B zone	When the operation continued for 2 minutes in B zone, defrost operation starts.							
C zone	When $Te_0 - TE \geq 3$ continued for 2 minutes in C zone, defrost operation starts.							

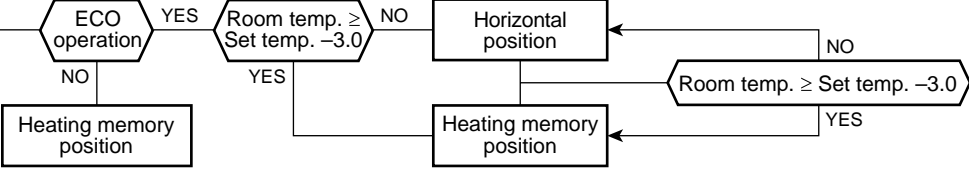
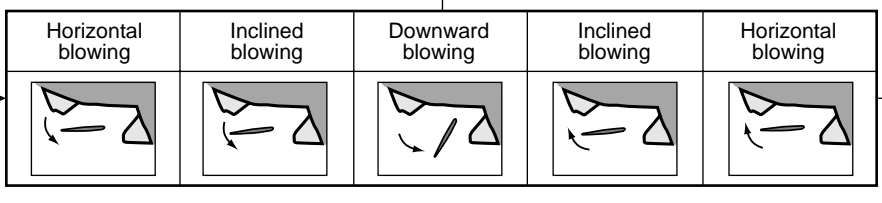
Item	Operation flow and applicable data, etc.	Description					
9. Louver control 1) Louver position	<p>This function controls the air direction of the indoor unit.</p> <ul style="list-style-type: none"> The position is automatically controlled according to the operation mode (COOL/HEAT). The set louver position is stored in memory by the microcomputer, and the louver returns to the stored position when the next operation is performed. (Cooling/heating memory position) <p>The angle of the louver is indicated as the horizontal angle is 0°.</p> <p>When the louver closes fully, it directs approx. 49° upward.</p> <p>1) Louver position in cooling operation</p>						
<p>Cooling operation/ AUTO (COOL) / DRY</p>  <p>Initial setting of "Cooling storage position" Louver : Directs downward (9°)</p>	<p style="text-align: center;">Powerful</p> <table border="1" style="width: 100%;"> <tr> <td style="width: 33%;">Room temp. (Ta) < Set temp. (Tsc) + 3.5</td> <td style="width: 33%;">Room temp. (Ta) ≥ Set temp. (Tsc) + 3.5</td> </tr> </table>  <table border="1" style="width: 100%;"> <tr> <td style="width: 33%;">Initial setting of "Cooling storage position" Louver : Directs downward (9°)</td> <td style="width: 33%;">Initial setting of "Cooling storage position" Louver : Directs downward (9°)</td> <td style="width: 33%;">"Inclined blowing" Louver : Directs downward (14°)</td> </tr> </table>		Room temp. (Ta) < Set temp. (Tsc) + 3.5	Room temp. (Ta) ≥ Set temp. (Tsc) + 3.5	Initial setting of "Cooling storage position" Louver : Directs downward (9°)	Initial setting of "Cooling storage position" Louver : Directs downward (9°)	"Inclined blowing" Louver : Directs downward (14°)
Room temp. (Ta) < Set temp. (Tsc) + 3.5	Room temp. (Ta) ≥ Set temp. (Tsc) + 3.5						
Initial setting of "Cooling storage position" Louver : Directs downward (9°)	Initial setting of "Cooling storage position" Louver : Directs downward (9°)	"Inclined blowing" Louver : Directs downward (14°)					
<p>Cooling/AUTO (COOL)/DRY operation</p>							
<p>2) Louver position in heating operation</p>							
<p>Heating operation/ AUTO (HEAT)</p>  <p>Initial setting of "Heating storage position" Louver : Directs downward (76°)</p>	<p style="text-align: center;">ECO operation</p> <table border="1" style="width: 100%;"> <tr> <td style="width: 33%;">Room temp. (Ta) < Set temp. (Tsc) - 3 or 25 minutes after start of operation</td> <td style="width: 33%;">Room temp. (Ta) ≥ Set temp. (Tsc) - 3</td> </tr> </table>  <table border="1" style="width: 100%;"> <tr> <td style="width: 33%;">Initial setting of "Heating storage position" Louver : Directs downward (76°)</td> <td style="width: 33%;">"Heating storage position" Louver : Directs downward (76°)</td> <td style="width: 33%;">"Cooling storage position" Louver : Directs downward (9°)</td> </tr> </table>		Room temp. (Ta) < Set temp. (Tsc) - 3 or 25 minutes after start of operation	Room temp. (Ta) ≥ Set temp. (Tsc) - 3	Initial setting of "Heating storage position" Louver : Directs downward (76°)	"Heating storage position" Louver : Directs downward (76°)	"Cooling storage position" Louver : Directs downward (9°)
Room temp. (Ta) < Set temp. (Tsc) - 3 or 25 minutes after start of operation	Room temp. (Ta) ≥ Set temp. (Tsc) - 3						
Initial setting of "Heating storage position" Louver : Directs downward (76°)	"Heating storage position" Louver : Directs downward (76°)	"Cooling storage position" Louver : Directs downward (9°)					
<p>Heating operation</p>							
<p>2) Air direction adjustment</p>	<p style="text-align: center;">Air direction</p>						
	<ul style="list-style-type: none"> The louver position can be arbitrarily set up by pressing [FIX] button. 						
<p>3) Swing</p>	<ul style="list-style-type: none"> Swing operation is performed in width 35° with the stop position as the center. If the stop position exceeds either upper or lower limit position, swing operation is performed in width 35° from the limit which the stop position exceeded. <ul style="list-style-type: none"> Swing When pressing [SWING] button during operation, the louver starts swinging. 						

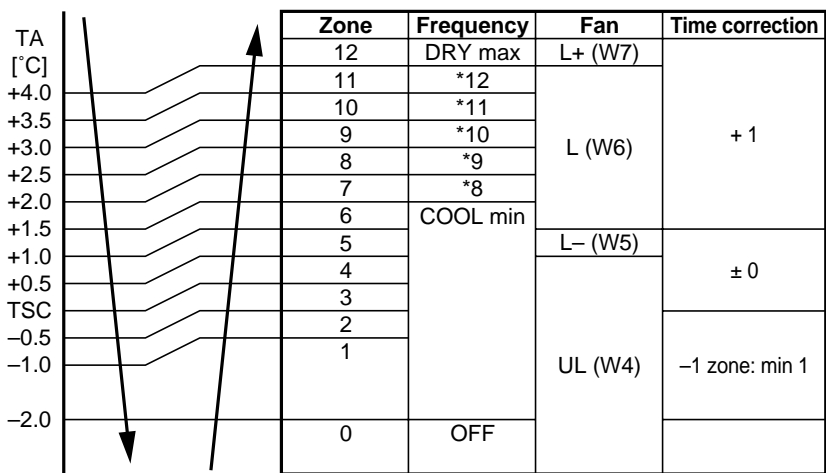
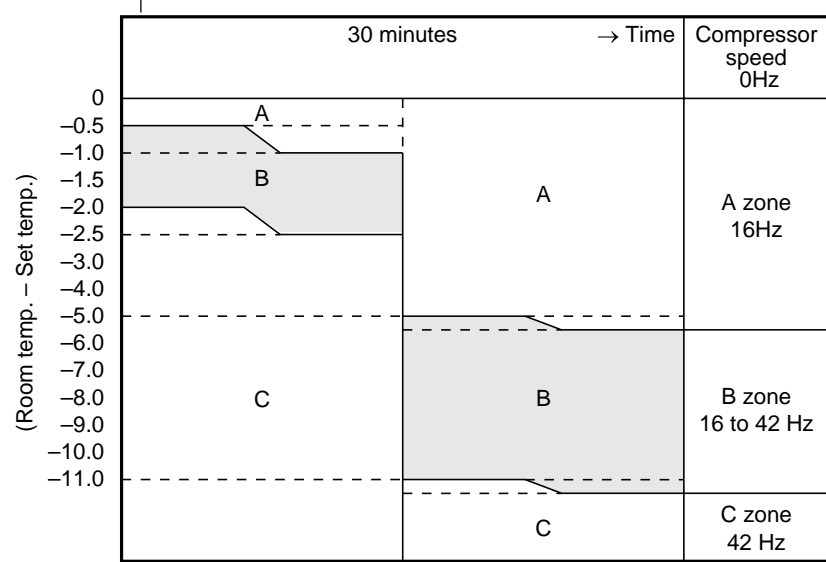
Item	Operation flow and applicable data, etc.	Description																																																				
<p>10. ECO operation</p>	<p>When pressing [ECO] button on the remote controller, a quiet and mild operation is performed by reducing the fan speed and the compressor speed.</p> <p><Cooling operation></p> <p>This function operates the air conditioner with the difference between the set and the room temperature as shown in the following figure.</p> <p>The time correction is performed for 8 minutes each. (However, the first correction is performed 150 seconds after start of the operation.)</p>  <table border="1" data-bbox="454 616 997 1075"> <thead> <tr> <th>Zone</th> <th>Frequency</th> <th>Fan</th> <th>Time correction</th> </tr> </thead> <tbody> <tr> <td>12</td> <td>DRY max</td> <td>L+ (W7)</td> <td rowspan="6">+ 1</td> </tr> <tr> <td>11</td> <td>*12</td> <td rowspan="6">L (W6)</td> </tr> <tr> <td>10</td> <td>*11</td> </tr> <tr> <td>9</td> <td>*10</td> </tr> <tr> <td>8</td> <td>*9</td> </tr> <tr> <td>7</td> <td>*8</td> </tr> <tr> <td>6</td> <td rowspan="3">COOL min</td> <td rowspan="3">L- (W5)</td> <td rowspan="3">± 0</td> </tr> <tr> <td>5</td> </tr> <tr> <td>4</td> </tr> <tr> <td>3</td> <td rowspan="2">UL (W4)</td> <td rowspan="2">-1 zone: min 1</td> </tr> <tr> <td>2</td> </tr> <tr> <td>1</td> <td></td> <td></td> <td></td> </tr> <tr> <td>0</td> <td>OFF</td> <td></td> <td></td> </tr> </tbody> </table> <p>* 12 (DRY max - COOL min) /6 x 5 + COOL min * 11 (DRY max - COOL min) /6 x 4 + COOL min * 10 (DRY max - COOL min) /6 x 3 + COOL min * 9 (DRY max - COOL min) /6 x 2 + COOL min * 8 (DRY max - COOL min) /6 x 1 + COOL min</p> <p><Heating operation></p>  <table border="1" data-bbox="295 1355 997 1904"> <thead> <tr> <th>Room temp. - Set temp. (°C)</th> <th>Time</th> <th>Compressor speed (Hz)</th> </tr> </thead> <tbody> <tr> <td>0 to -0.5</td> <td>0 to 30 minutes</td> <td>0Hz</td> </tr> <tr> <td>-0.5 to -2.5</td> <td>30 to 60 minutes</td> <td>A zone 16Hz</td> </tr> <tr> <td>-2.5 to -11.0</td> <td>60 to 90 minutes</td> <td>B zone 16 to 42 Hz</td> </tr> <tr> <td>-11.0 to -11.0</td> <td>90 to 120 minutes</td> <td>C zone 42 Hz</td> </tr> </tbody> </table>	Zone	Frequency	Fan	Time correction	12	DRY max	L+ (W7)	+ 1	11	*12	L (W6)	10	*11	9	*10	8	*9	7	*8	6	COOL min	L- (W5)	± 0	5	4	3	UL (W4)	-1 zone: min 1	2	1				0	OFF			Room temp. - Set temp. (°C)	Time	Compressor speed (Hz)	0 to -0.5	0 to 30 minutes	0Hz	-0.5 to -2.5	30 to 60 minutes	A zone 16Hz	-2.5 to -11.0	60 to 90 minutes	B zone 16 to 42 Hz	-11.0 to -11.0	90 to 120 minutes	C zone 42 Hz	<p><Cooling operation></p> <ol style="list-style-type: none"> 1) The room temperature (Tao) at the start time of DRY operation is detected. 2) According to difference between the room temperature and the set temperature (Tsc), the operation starts with the conditions shown in the left figure. Set temp. (Tsc) = Set temp. on remote controller (Ts) + (0.0 to 1.0) 3) If the room temperature is down by 2°C or more, turn off the compressor. <p><Heating operation></p> <ol style="list-style-type: none"> 1) The indoor fan speed is controlled within (W7) as maximum value. 2) Setting the compressor speed to Max. 42 Hz, the temperature zone in which the operation can be performed with Max. 16Hz is gradually widened after 30 minutes passed when starting ECO operation. 3) The louver position is set horizontally (Standard cooling position) when the room temperature comes close to the set temperature or when 25 minutes passed after starting ECO operation.
Zone	Frequency	Fan	Time correction																																																			
12	DRY max	L+ (W7)	+ 1																																																			
11	*12	L (W6)																																																				
10	*11																																																					
9	*10																																																					
8	*9																																																					
7	*8																																																					
6	COOL min		L- (W5)	± 0																																																		
5																																																						
4																																																						
3	UL (W4)	-1 zone: min 1																																																				
2																																																						
1																																																						
0	OFF																																																					
Room temp. - Set temp. (°C)	Time	Compressor speed (Hz)																																																				
0 to -0.5	0 to 30 minutes	0Hz																																																				
-0.5 to -2.5	30 to 60 minutes	A zone 16Hz																																																				
-2.5 to -11.0	60 to 90 minutes	B zone 16 to 42 Hz																																																				
-11.0 to -11.0	90 to 120 minutes	C zone 42 Hz																																																				

Item	Operation flow and applicable data, etc.	Description
11. Temporary operation	<p>Pressing [RESET] button starts the temporary operation of [AUTO] operation. When keeping [RESET] button pressed for 10 seconds or more, the temporary [COOL] operation is performed.</p>	<ol style="list-style-type: none"> When pressing [RESET] button, the temporary [AUTO] operation starts. When keeping [RESET] button pressed for 3 seconds or more, Pi, Pi, Pi sound is heard and [AUTO RESTART] control is changed. When keeping [RESET] button pressed for 10 seconds or more, "Pi" sound is heard and the temporary [COOL] operation starts. If the filter lamp goes on, press [RESET] button to go off the filter lamp, and then press [RESET] button again. To stop the temporary operation, press the button again.

12. Air purifying control	<p>This function generates negative ion while cleaning the air in the room.</p> <p>If air purifier-ON signal is received while the air conditioner stops, the air purifier starts operation, and if it is received while the air conditioner operates, the air conditioner and the air purifier start operation.</p> <p>The air ion generator operates linked with the air purifying operation.</p>	
---------------------------	---	--

Present status	Operation button	
	PURE button	Air conditioner
Stop	Air purifier	AC operation*
Air purifier only	Stop (All)	AC + Air purifier
Air conditioner	AC + Air purifier	All stop
Joint use of AC and air purifier	AC operation	All stop

	Louver*1	Fan speed *2
Air purifying operation	Cooling position	AUTO, L, L+, M, M+, H
AC + Air purifying operation	Follows to AC operation	Follows to AC operation

* When the previous operation was the operation of air conditioner + air purifier, an operation of air conditioner + air purifier starts by pushing AC button on the remote controller.
(Operation of air conditioner + air purifier is stored in memory.)

*1 Swing is available

*2 Fan speed is Fan Auto mode varies in order, (M + 1) → (L) → (L-) → (SL).

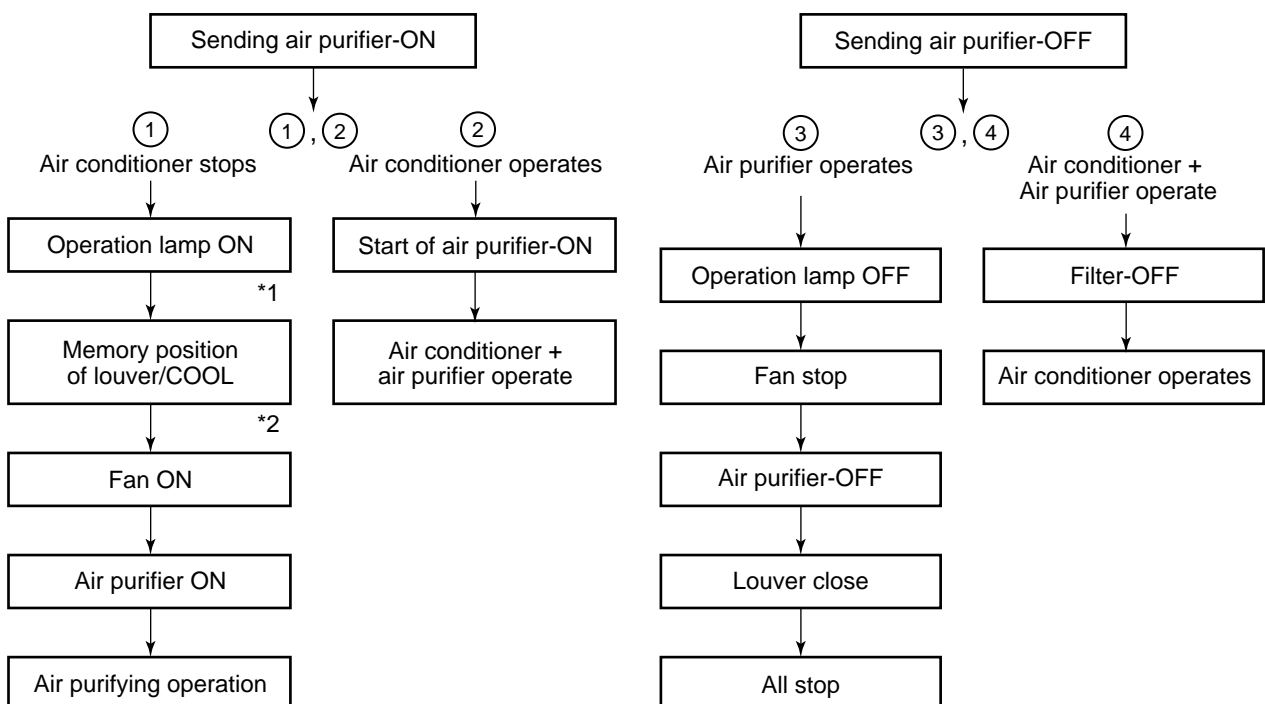

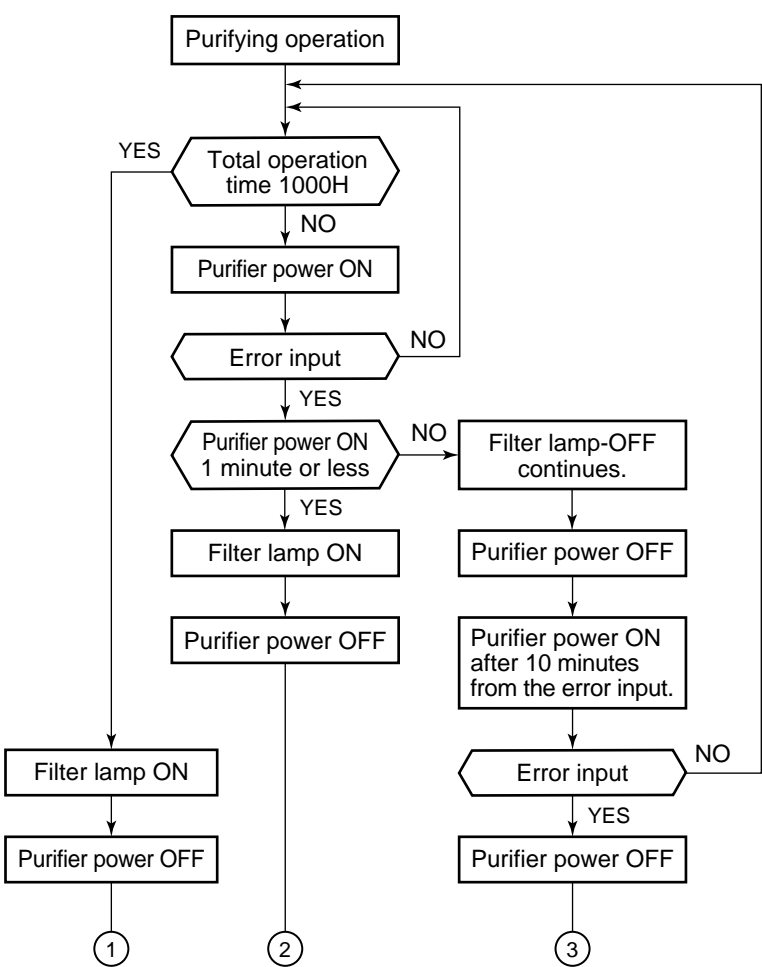
Item	Operation flow and applicable data, etc.	Description														
<p>12. Air purifying control [Detection of abnormality]</p>  <p>1) Reset by RESET button. 2) Reset by RESET button or by the stop direction from the remote controller. * When the breaker is turned [ON] (In restart time after power failure) or RESET button is pressed while the FILTER indicator is turned on, the air purifier is not turned on until the integrated operation time of the indoor fan exceeds 1 hour after operation start (It is not the air purifier operation time). It is the safety measures considering an incomplete drain when electric dust collector has been cleaned with water.</p>	<p>1. Purpose The air purifying control function is to alert the user to trouble in the ionizing or air purifying operation.</p> <p>2. Description Trouble is determined to have occurred (indicated by the FILTER indicator) in the following four cases.</p> <ol style="list-style-type: none"> 1) When a count of 1000H has been reached on the timer 2) When the panel switch has been set to OFF by the opening of the air inlet grille, etc. 3) When an abnormal discharge caused by a symptom such as the build-up of dirt has been detected while the air purifier is ON 4) When the electric dust collector has not been installed correctly <p>* Trouble case (2) or (3) is deemed to have occurred when the action concerned continues for more than one second.</p> <p>3. Operation The sequence that FILTER indicator is turned on are described in the left flowchart.</p> <ol style="list-style-type: none"> 1) When 1000H timer counts up, the FILTER indicator keeps lighting even if the operation is stopped by the remote controller. The timer is stored in memory of the microcomputer, and the operation time is cleared by filter RESET button on the indoor unit or a power failure. (FILTER indicator goes off.) 2) A trouble detected within 1 minute after activation of the air is immediately judged as an error and the FILTER indicator goes on. 3) In case that 1 minute passed after activation of the purifier, the purifier is turned off while the PURE indicator keeps ON. After 10 minutes passed, restart the purifier and an error is judged again. 	<p>1. Purpose This function detects error on the refrigerating cycle or error on the compressor, and performs protective control.</p> <p>2. Operation</p> <ul style="list-style-type: none"> • Control of the compressor speed The speed control is performed as described in the left table based upon the discharge temperature. 														
<p>13. Discharge temperature control</p> <table border="1" data-bbox="159 1702 925 2049"> <thead> <tr> <th>Td value</th> <th>Control operation</th> </tr> </thead> <tbody> <tr> <td>117°C</td> <td>Judges as an error and stops the compressor.</td> </tr> <tr> <td>112°C</td> <td>Reduce the compressor speed.</td> </tr> <tr> <td>108°C</td> <td>Reduce slowly compressor speed.</td> </tr> <tr> <td>105°C</td> <td>Keeps the compressor speed.</td> </tr> <tr> <td>98°C</td> <td>If the operation is performed with lower speed than one commanded by the serial signal, speed is slowly raised up to the commanded speed.</td> </tr> <tr> <td></td> <td>Operates with speed commanded by the serial signal.</td> </tr> </tbody> </table>	Td value	Control operation	117°C	Judges as an error and stops the compressor.	112°C	Reduce the compressor speed.	108°C	Reduce slowly compressor speed.	105°C	Keeps the compressor speed.	98°C	If the operation is performed with lower speed than one commanded by the serial signal, speed is slowly raised up to the commanded speed.		Operates with speed commanded by the serial signal.		<p>1. Purpose This function detects error on the refrigerating cycle or error on the compressor, and performs protective control.</p> <p>2. Operation</p> <ul style="list-style-type: none"> • Control of the compressor speed The speed control is performed as described in the left table based upon the discharge temperature.
Td value	Control operation															
117°C	Judges as an error and stops the compressor.															
112°C	Reduce the compressor speed.															
108°C	Reduce slowly compressor speed.															
105°C	Keeps the compressor speed.															
98°C	If the operation is performed with lower speed than one commanded by the serial signal, speed is slowly raised up to the commanded speed.															
	Operates with speed commanded by the serial signal.															

Item	Operation flow and applicable data, etc.	Description
<p>14. Pulse motor valve (P.M.V.) control</p>	<p>This function controls throttle amount of the refrigerant in the refrigerating cycle. According to operating status of the air conditioner, this function also controls the open degree of valve with an expansion valve with pulse motor.</p> <pre> graph TD Start[Starting up] --> Init[Initialize] Init --> Move[Move to initial position] Move --> Comp[Compressor ON] Comp --> SH[SH control] Comp --> Dis[Discharge temp. control] SH --> PMV[PMV open degree control] Dis --> PMV PMV --> Stop[Stop by remote controller] PMV --> Room[Room temp. sensor (Ta sensor) control] Stop --> Power[Power OFF] Room --> Defrost[Defrost] Defrost --> Move </pre> <p>* SH (Super Heat amount) = Ts (Temperature of suction pipe of the compressor) – Tc or Te (Heat exchanger temperature at evaporation side)</p> <p>* PMV: Pulse Motor Valve</p>	<ol style="list-style-type: none"> 1) When starting the operation, move the valve once until it fits to the stopper. (Initialize) * In this time, "Click" sound may be heard. 2) Adjust the open degree of valve by super heat amount. (SH control) 3) If the discharge temperature was excessively up, adjust the open degree of valve so that it is in the range of set temperature. (Discharge temp. control) 4) When defrost operation is performed, the open degree of valve is adjusted according to each setup conditions during preparation for defrost and during defrost operation (4-way valve is inversed.). 5) To turn off the compressor while the air conditioner stops by control of the thermostat or by remote controller, adjust the open degree of valve to the setup value before stop of the compressor.

Item	Operation flow and applicable data, etc.	Description															
<p>15. Clean operation</p>	<div style="text-align: center;"> <pre> graph TD A[Unit now performing cooling or dry operation] --> B[Press "STOP" button] B --> C[Only S.CLEAN indicator lights, and clean operation starts] C --> D[Time set now elapses] D --> E[Operation stops] </pre> </div> <ul style="list-style-type: none"> • During clean operations: The louver opens slightly. The indoor fan operates continuously at a speed of 260 rpm. Clean operation times <table border="1" data-bbox="405 1137 1225 1482"> <thead> <tr> <th>Operation mode</th> <th>Operation time</th> <th>Clean operation time</th> </tr> </thead> <tbody> <tr> <td rowspan="3">Cooling: Auto (cooling) Dry</td> <td>Up to 10 minutes</td> <td>No clean operation performed (0 minutes)</td> </tr> <tr> <td>From 10 minutes up to 1 hour</td> <td>2 hours</td> </tr> <tr> <td>1 hour or longer</td> <td>4 hours</td> </tr> <tr> <td>Heating: Auto (heating)</td> <td colspan="2" rowspan="3">No clean operation performed</td> </tr> <tr> <td>Auto (fan only)</td> </tr> <tr> <td>Shutdown</td> </tr> </tbody> </table> <ul style="list-style-type: none"> • To stop an ongoing clean operation at any time Press the start/stop button on the remote controller twice during the clean operation. (After pressing the button for the first time, press it for the second time without delay (within 10 minutes).) 	Operation mode	Operation time	Clean operation time	Cooling: Auto (cooling) Dry	Up to 10 minutes	No clean operation performed (0 minutes)	From 10 minutes up to 1 hour	2 hours	1 hour or longer	4 hours	Heating: Auto (heating)	No clean operation performed		Auto (fan only)	Shutdown	<p>1. Purpose</p> <p>The clean operation is to minimize the growth of mold, bacteria etc. by running the fan and drying so as to keep the inside of the air conditioner clean.</p> <p>Clean operation</p> <p>When the cooling or dry operation shuts down, the unit automatically starts the clean operation which is then performed for the specified period based on duration of the operation which was performed prior to the shutdown, after which the clean operation stops. (The clean operation is not performed after a heating operation.)</p> <p>2. Operation</p> <ol style="list-style-type: none"> 1) When the stop signal from the remote controller is received, the S.CLEAN indicator (green) on the main body lights, and the clean operation starts. (Neither the OPERATION indicator nor the TIMER indicator light.) 2) The period of the clean operation is determined by the duration of the operation performed prior to the reception of the stop code. 3) After the clean operation has been performed for the specified period, the unit stops operating.
Operation mode	Operation time	Clean operation time															
Cooling: Auto (cooling) Dry	Up to 10 minutes	No clean operation performed (0 minutes)															
	From 10 minutes up to 1 hour	2 hours															
	1 hour or longer	4 hours															
Heating: Auto (heating)	No clean operation performed																
Auto (fan only)																	
Shutdown																	

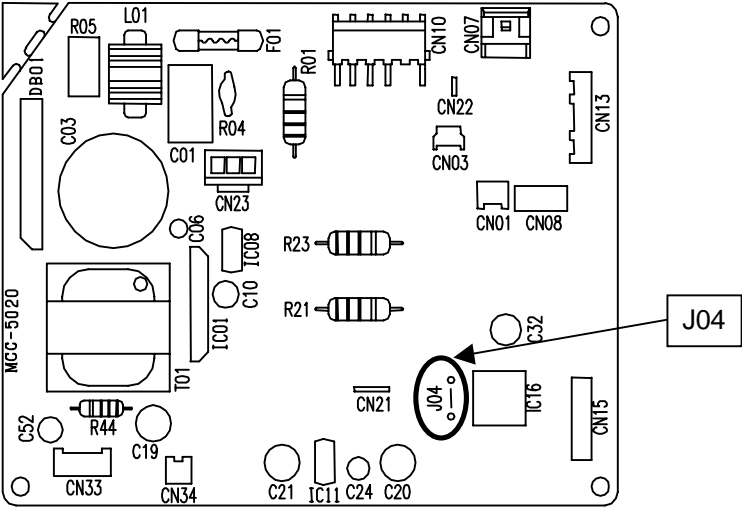
Item	Operation flow and applicable data, etc.	Description
<p>16. Clean operation release</p>	<p>Setting the clean operation release</p> <div style="border: 1px solid black; padding: 5px; margin-bottom: 5px;">Add J04 of the indoor P.C. board assembly. * This cancels the auto restart function.</div> <p style="text-align: center;">↓</p> <div style="border: 1px solid black; padding: 5px; margin-bottom: 5px;">Hold down the auto operation switch on the indoor unit for at least 3 seconds but not more than 10 seconds.</div> <p style="text-align: center;">↓</p> <div style="border: 1px solid black; padding: 5px; margin-bottom: 5px;">The indoor unit's buzzer emits three beeps, and the OPERATION indicator flashes at 5 Hz intervals.</div> <p style="text-align: center;">↓</p> <div style="border: 1px solid black; padding: 5px; margin-bottom: 5px;">This completes the clean operation release setting.</div> <p>Setting the clean operation</p> <div style="border: 1px solid black; padding: 5px; margin-bottom: 5px;">Cut J04 of the indoor P.C. board * This step may be skipped if the auto restart function is not required.</div> <p style="text-align: center;">↓</p> <div style="border: 1px solid black; padding: 5px; margin-bottom: 5px;">Hold down the auto operation switch on the indoor unit for at least 3 seconds but not more than 10 seconds.</div> <p style="text-align: center;">↓</p> <div style="border: 1px solid black; padding: 5px; margin-bottom: 5px;">The indoor unit's buzzer emits three beeps, and the OPERATION indicator flashes at 5 Hz intervals.</div> <p style="text-align: center;">↓</p> <div style="border: 1px solid black; padding: 5px; margin-bottom: 5px;">This completes the clean operation setting.</div> <p>Indoor P.C. board</p> 	<p>* J04 will be near the MCU so take steps to ensure that it will not be exposed to excessive levels of heat.</p> <p>Also take care to avoid solder bridging with the surrounding components.</p>

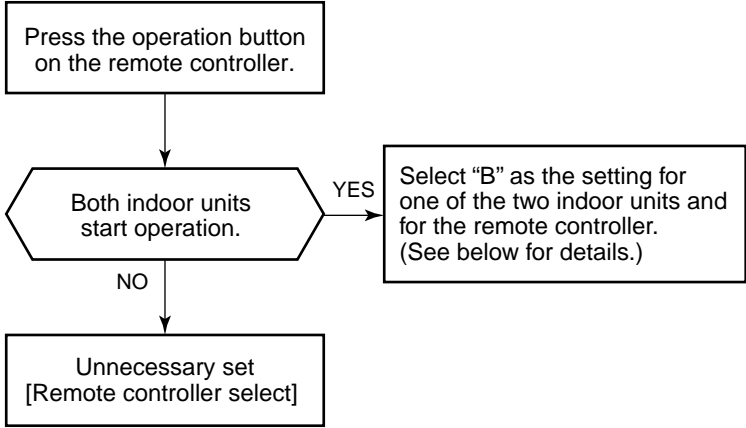
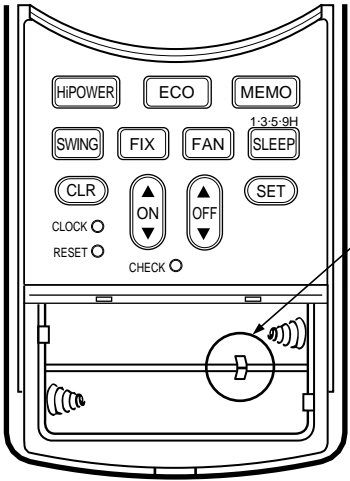
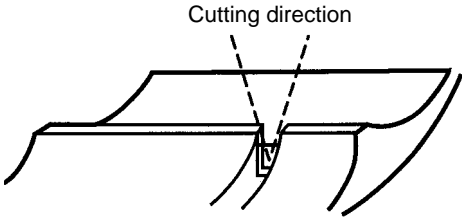
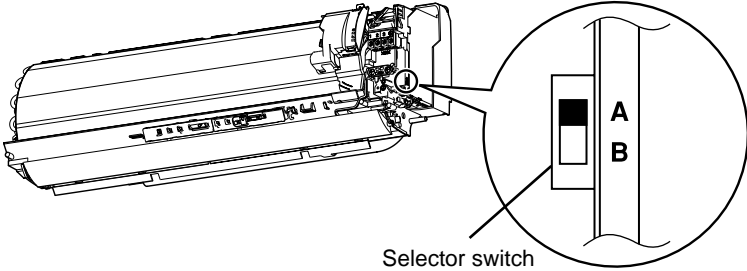
Item	Operation flow and applicable data, etc.	Description
<p>17. Select switch on remote controller</p>		<p>1. Purpose This operation is to operate only one indoor unit using one remote controller.</p> <p>2. Description When operating one indoor unit in a situation where two indoor units have been installed in the same room or nearby rooms, this operation prevents the remote controller signal from being received simultaneously by both units, thus preventing both units from operating.</p> <p>3. Operation The indoor unit on which the remote controller selection has been set to B receives the signal of the remote controller also set to B. (At the factory the remote controller selection is set to A on all the indoor units. There is no A setting display.)</p>
 <p style="text-align: center;">Jumper wire</p>  <p style="text-align: center;">Cutting direction</p>	<p>Setting the remote controller</p> <p>Switching between A and B is enabled by cutting the jumper wire inside the battery box using pliers.</p> <ol style="list-style-type: none"> 1) Slide open the remote controller cover and remove the batteries. 2) Cut the jumper wire inside the battery compartment using nippers. <ul style="list-style-type: none"> • The jumper wire should not remain in contact after being cut. Also, be careful not to let plastic scraps, jumper wire cuttings or other debris enter the inside of the remote controller. 3) Insert the batteries. "B" appears in the remote controller display. <p>* Even after the jumper wire has been cut, switching between A and B is still possible by pressing the CHECK button and FIX button together. The A or B setting, which was switched by pressing the CHECK button and FIX button together, is restored to the setting established prior to the switching when the battery is replaced or the RESET button is pressed.</p> <p>Setting the selector switch on the main unit</p> <ul style="list-style-type: none"> • Remove the front panel, and then set the selector switch to "B". • After making the switch setting, remount the front panel. 	 <p style="text-align: center;">Position of remote controller selector switch</p> <p style="text-align: center;">Selector switch</p>
<p>When switching between settings "A" and "B", always switch the indoor unit board and the remote controller as a pair. (Otherwise, the indoor unit will not accept the remote controller's signals.)</p>		

9-3. Auto Restart Function

This indoor unit is equipped with an automatic restarting function which allows the unit to restart operating with the set operating conditions in the event of a power supply being accidentally shut down.

The operation will resume without warning three minutes after power is restored.

This function is not set to work when shipped from the factory. Therefore it is necessary to set it to work.

9-3-1. How to Set the Auto Restart Function

To set the auto restart function, proceed as follows:

The power supply to the unit must be on ; the function will not set if the power is off.

Press the [RESET] button located in the center of the front panel continuously for three seconds.

The unit receives the signal and beeps three times.

The unit then restarts operating automatically in the event of power supply being accidentally shut down.

• When the unit is standby (Not operating)

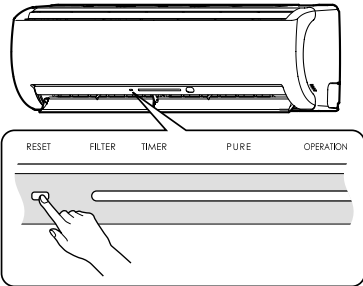
Operation	Motions
<p>Press [RESET] button for more than three seconds. (Less than 10 seconds)</p> 	<p>The unit is on standby.</p> <p style="text-align: center;">↓</p> <p>The unit starts to operate. The green indicator is on.</p> <p style="text-align: center;">↓ After approx. three seconds,</p> <p>The unit beeps three times and continues to operate. The green indicator flashes for 5 seconds.</p> <p>If the unit is not required to operate at this time, press [RESET] button once more or use the remote controller to turn it off.</p>

• When the unit is in operation

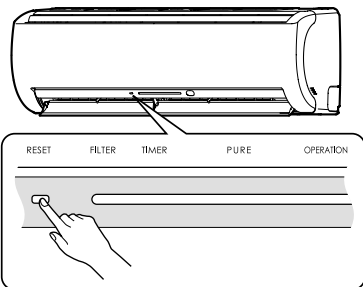
Operation	Motions
<p>Press [RESET] button for more than three seconds. (Less than 10 seconds)</p> 	<p>The unit is in operation. The green indicator is on.</p> <p style="text-align: center;">↓</p> <p>The unit stops operating. The green indicator is turned off.</p> <p style="text-align: center;">↓ After approx. three seconds,</p> <p>The unit beeps three times. The green indicator flashes for 5 seconds.</p> <p>If the unit is required to operate at this time, press [RESET] button once more or use the remote controller to turn it on.</p>

- When the unit is turned on by this function, the louver will not swing even though it was swinging automatically before shutting down.
- While the filter check indicator is on, the RESET button has the function of filter reset button.

9-3-2. How to Cancel the Auto Restart Function

To cancel auto restart function, proceed as follows :

Repeat the setting procedure : the unit receives the signal and beeps three times.

The unit will be required to be turned on with the remote controller after the main power supply is turned off.

• **When the system is on stand-by (not operating)**

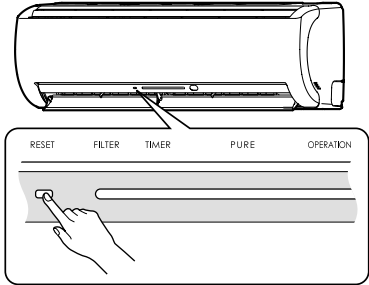
Operation	Motions
<p>Press [RESET] button for more than three seconds. (Less than 10 seconds)</p> 	<p>The unit is on standby.</p> <p style="text-align: center;">↓</p> <p>The unit starts to operate. The green indicator is on.</p> <p style="text-align: center;">↓ After approx. three seconds,</p> <p>The unit beeps three times and continues to operate.</p> <p>If the unit is not required to operate at this time, press [RESET] button once more or use the remote controller to turn it off.</p>

• **When the system is operating**

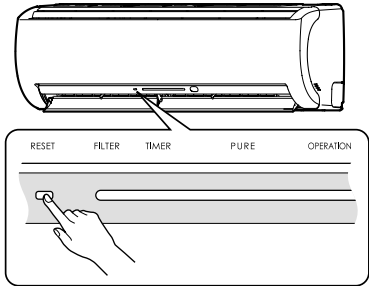
Operation	Motions
<p>Press [RESET] button for more than three seconds. (Less than 10 seconds)</p> 	<p>The unit is in operation. The green indicator is on.</p> <p style="text-align: center;">↓</p> <p>The unit stops operating. The green indicator is turned off.</p> <p style="text-align: center;">↓ After approx. three seconds,</p> <p>The unit beeps three times.</p> <p>If the unit is required to operate at this time, press [RESET] button once more or use the remote controller to turn it on.</p>

9-3-3. Power Failure During Timer Operation

When the unit is turned off because of power failure during timer operation, the timer operation is cancelled. In that case, set the timer operation again.

NOTE :

The Everyday Timer is reset while a command signal can be received from the remote controller even if it stopped due to a power failure.

9-4. FILTER Indicator

When the elapsed time reaches 1000 hours after air purifier operation, the FILTER indicator lights. After cleaning the filters, turn off the FILTER indicator.

9-4-1. How to Turn Off FILTER Indicator

Press [RESET] button on the indoor unit.















NOTE :

If [RESET] button is pushed while the FILTER indicator is not lit, the indoor unit will start the automatic operation.

When you want a temporary operation while the FILTER lamp lights, press [RESET] button to turn off the FILTER lamp. (See page 47)

9-5. Remote Controller and Its Functions

9-5-1. Parts Name of Remote Controller

- 1 Infrared signal emitter**
Transmits signal to the indoor unit.
- 2  button**
Press the button to start operation.
(A receiving beep is heard.)
Press the button again to stop operation.
(A receiving beep is heard.)
If no receiving sound is heard from the indoor unit, press the button twice.
- 3 Mode select button (MODE)**
Press this button to select a mode.
Each time you press the button, the modes cycle in order from A : Auto changeover control,
 : Cool,  : Dry,  : Heat and back to A.
(A receiving beep is heard.)
- 4 Temperature button ()**
▲ .. The temperature setting is increased to 30°C.
▼ .. The temperature setting is reduced to 17°C.
(A receiving beep is heard.)
- 5 Fan speed button (FAN)**
Press this button to select the fan speed.
When you select AUTO, the fan speed is automatically adjusted according to the room temperature.
You can also manually select the desired fan speed from five available settings.
(LOW  , LOW+  , MED  , MED+  , HIGH ) (A receiving beep is heard.)
- 6 Auto louver button (SWING)**
Press this button to swing the louver.
(A receiving beep is heard.)
Press this button again to stop the louver from swinging. (A receiving beep is heard.)
- 7 Set louver button (FIX)**
Press this button again to adjust the air flow direction. (A receiving beep is heard.)
- 8 ON timer button (ON)**
Use this button to change the clock and ON timer times.
To move up the time, press ▲ of the "ON  " button.
To move down the time, press ▼ of the "ON  " button.
- 9 OFF timer button (OFF)**
Use this button to change the OFF timer times.
To move up the time, press ▲ of the "OFF  " button.
To move down the time, press ▼ of the "OFF  " button.
- 10 Reserve button (SET)**
Press this button to store the time settings.
(A receiving beep is heard.)
- 11 Cancel button (CLR)**
Press this button to cancel the ON timer and OFF timer. (A receiving beep is heard.)
- 12 High power button (Hi POWER)**
Press this button to start high power operation.
- 13 Memory button (MEMO)**
Press this button to ready for storing the settings.
Hold down the button for more than 3 seconds to store the setting indicated on the remote controller and until the  mark is displayed.
- 14 Automatic operation button (AUTO)**
Press this button to operate the air conditioner automatically. (A receiving beep is heard.)
- 15 Economy button (ECO)**
Press this button to operate the air conditioner economically.
- 16 PRESET button**
Press this button to operate the air conditioner to the settings stored using the MEMO button.
- 17 PURE button (PURE)**
Press this button to start the electrical air purifying operation.
Press the button again to stop operation.
- 18 Sleep time button (SLEEP)**
Press this button to start the sleep timer (OFF timer) operation.
You can select the OFF timer time from among four settings (1, 3, 5 or 9 hours).

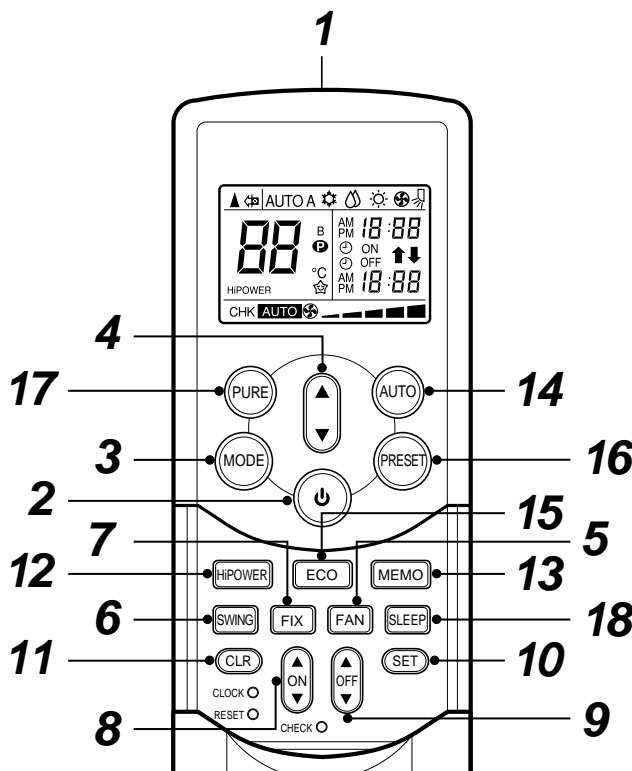

9-5-2. Name and Functions of Indications on Remote Controller



[Display]

All indications, except for the clock time indicator, are displayed by pressing the  button.

1 Transmission mark

This transmission mark  indicates when the remote controller transmits signals to the indoor unit.

2 Mode indicator

Indicates the current operation mode.
(AUTO : Automatic control, A : Auto changeover control,  : Cool,  : Dry,  : Heat)

3 Temperature indicator

Indicates the temperature setting.
(17°C to 30°C)





4 PURE indicator

Shows that the electrical air purifying operation is in progress.

5 FAN speed indicator

Indicates the selected fan speed.

AUTO or five fan speed levels

(LOW , LOW+ , MED , MED+ , HIGH ) can be shown.

Indicates AUTO when the operating mode is either AUTO or  : Dry.

6 TIMER and clock time indicator

The time setting for timer operation or the clock time is indicated.

The current time is always indicated except during TIMER operation.

7 HI-POWER indicator

Indicates when the HI-POWER operation starts.

Press the HI-POWER button to start and press it again to stop the operation.

8 (MEMORY) indicator

Flashes for 3 seconds when the MEMO button is pressed during operation.

The  mark is shown when holding down the button for more than 3 seconds while the mark is flashing.

Press another button to turn off the mark.

9 ECO indicator

Indicates when the ECO is in activated.

Press the ECO button to start and press it again to stop operation.

10 A, B change indicator remote controller

When the remote controller switching function is set, "B" appears in the remote controller display.
(When the remote controller setting is "A", there is no indication at this position.)

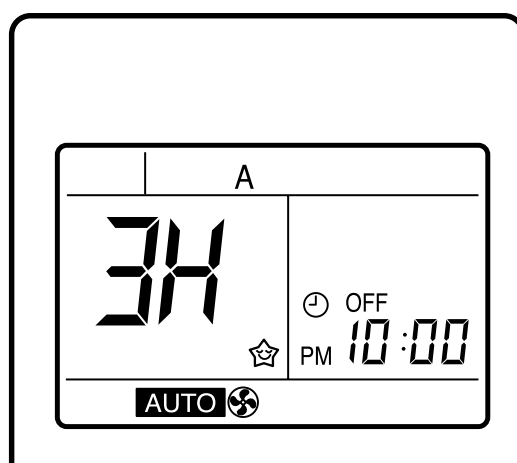
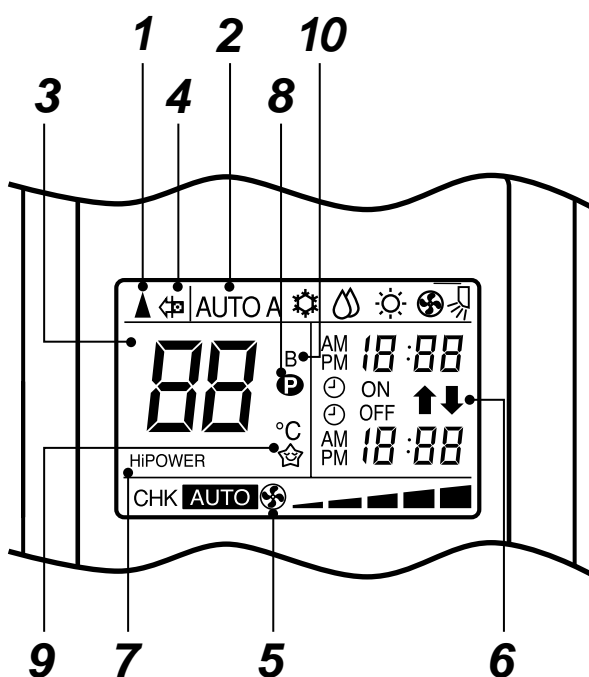

- In the illustration, all indications are shown for purposes of explanation.

During operation, only the relevant indicators are shown on the remote controller.

9-6. Hi-POWER Mode

([Hi-POWER] button on the remote controller is pressed)

When [Hi-POWER] button is pressed while the indoor unit is in Auto, Cooling or Heating operation, Hi-POWER mark is indicated on the display of the remote controller and the unit operates as follows.

1. Automatic operation

- The indoor unit operates in according to the current operation.

2. Cooling operation

- The preset temperature drops 1°C.
(The value of the preset temperature on the remote controller does not change.)
- If the difference between the preset temperature and the room temperature is big, the horizontal louver moves to the Hi-POWER position automatically.
Then when the difference between them gets smaller, the horizontal louver returns automatically.

3. Heating operation

- The preset temperature increases 2°C.
(The value of the preset temperature on the remote controller does not change.)

4. The Hi-POWER mode can not be set in Dry operation

9-7. Intermittent Operation Control for Indoor Fans of the Indoor Unit at Thermo-off Side in Heating Operation

While heating operation is executed in two rooms, if room temperature reached the setup temperature in one room and thermo-off occurred, the following operations start. (Refer to the figure below.)

1. The indoor unit of the room (A room) in which thermo-off did not occur starts a continuous operation with the setup number of revolution.
2. The indoor unit of the room (B room) in which thermo-off occurred starts intermittent operation of the indoor fan.

The indoor fan operates with number of revolution of UL or SUL. Fan-ON time is 2 minutes and Fan-OFF time is 2 to 4 minutes.

However if temperature of the indoor heat exchanger becomes over 55°C or more in B room, the indoor fan stops the intermittent operation and starts continuous operation.

While heating operation is executed in two rooms, if room temperature reached the setup temperature in both rooms and thermo-off occurred, both indoor units start intermittent operation of the indoor fan.

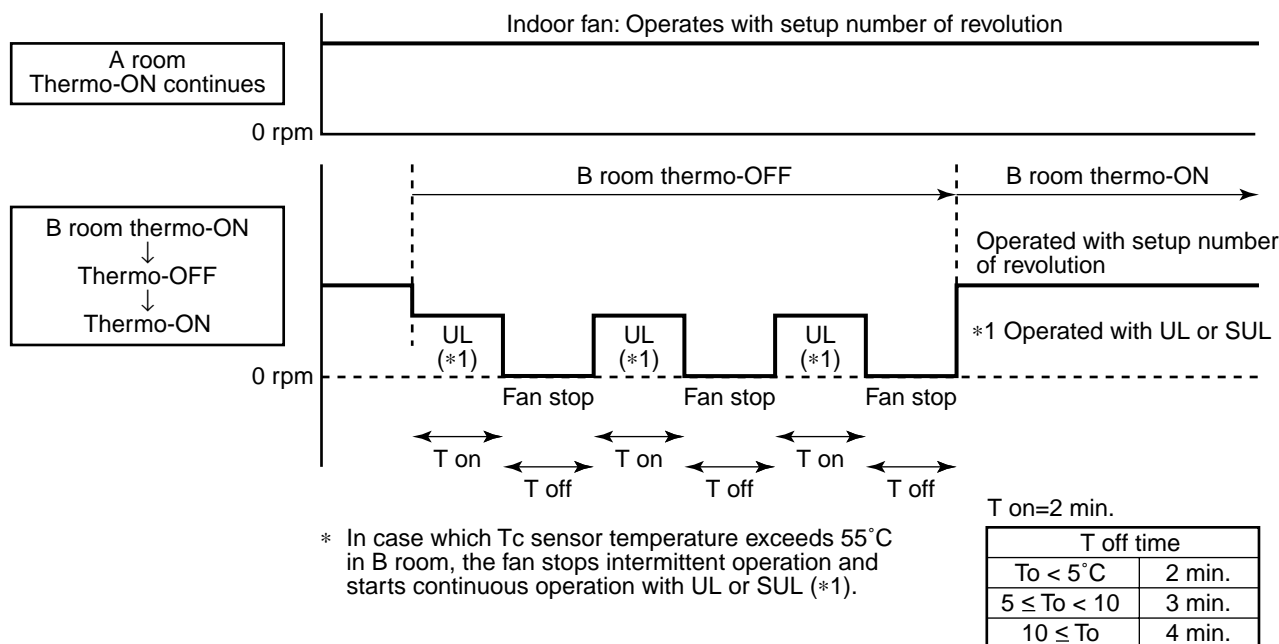

10. INSTALLATION PROCEDURE

10-1. Safety Cautions

For the rear left and left piping

Insert the cushion between the indoor unit and wall, and tilt the indoor unit for better installation work.

Do not allow the drain hose to become slack.

Cut the piping hole slightly sloped. Make sure the drain hose is sloped downward.

The auxiliary piping can be connected at the left, rear left, rear right, right, bottom right or bottom left as shown below.

As shown in the figure, position power cord and connecting cable downward, and lead out along piping connection port.

Insulate the refrigerant pipes separately, not together.

6 mm thick heat resisting polyethylene foam

Before installing the wireless remote controller

- With the remote controller cover removed, correctly load the supplied batteries while observing their polarity.

② Wireless remote controller

③ Batteries



② Wireless remote controller

10-2. Optional Parts, Accessories and Tools

10-2-1. Optional Installation Parts

Part Code	Parts name			Q'ty
①	Refrigerant piping			1 ea.
	Indoor unit name	Liquid side (Outer diameter)	Gas side (Outer diameter)	
	RAS-B10GKVP-E, B13GKVP-E	6.35 mm	9.52 mm	
	RAS-B16GKVP-E	6.35 mm	12.7 mm	
②	Shield pipe (for extension drain hose) (polyethylene foam, 6 mm thick)			1

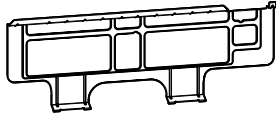
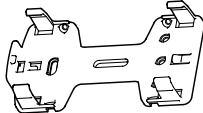
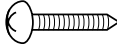
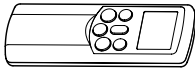
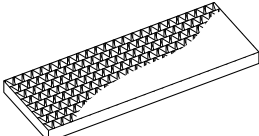
10-2-2. Accessory and Installation Parts

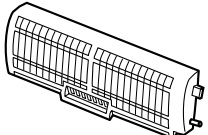
Part No.	Part name (Q'ty)	Part No.	Part name (Q'ty)	Part No.	Part name (Q'ty)					
①	 Installation plate x 1	④	 Remote control holder x 1	⑦	 Mounting screw Ø4 x 25L x 6					
②	 Wireless remote control x 1	⑤	 Zeolite-plus filter x 1	⑧	 Remote control holder mounting screw Ø3.1 x 16L x 2					
③	 Battery x 2	⑥	 Plasma pure filter x 1	<Others>						
				<table border="1"> <thead> <tr> <th>Name</th> </tr> </thead> <tbody> <tr> <td>Owner's manual (Indoor unit)</td> </tr> <tr> <td>Installation manual (Indoor unit)</td> </tr> <tr> <td>Installation manual (Outdoor unit)</td> </tr> <tr> <td>Specifications (Outdoor unit)</td> </tr> </tbody> </table>		Name	Owner's manual (Indoor unit)	Installation manual (Indoor unit)	Installation manual (Outdoor unit)	Specifications (Outdoor unit)
Name										
Owner's manual (Indoor unit)										
Installation manual (Indoor unit)										
Installation manual (Outdoor unit)										
Specifications (Outdoor unit)										

This model is not equipped with an extension drain hose.







10-2-3. Installation/Serviceing Tools

Changes in the product and components

In the case of an air conditioner using R410A, in order to prevent any other refrigerant from being charged accidentally, the service port diameter of the outdoor unit control valve (3-way valve) has been changed. (1/2 UNF 20 threads per inch)

- In order to increase the pressure resisting strength of the refrigerant piping flare processing diameter and size of opposite side of flare nuts has been changed. (for copper pipes with nominal dimensions 1/2 and 5/8)

New tools for R410A

New tools for R410A	Applicable to R22 model		Changes
Gauge manifold	×		As pressure is high, it is impossible to measure by means of conventional gauge. In order to prevent any other refrigerant from being charged, each port diameter has been changed.
Charge hose	×		In order to increase pressure resisting strength, hose materials and port size have been changed (to 1/2 UNF 20 threads per inch). When purchasing a charge hose, be sure to confirm the port size.
Electronic balance for refrigerant charging	○		As pressure is high and gasification speed is fast, it is difficult to read the indicated value by means of charging cylinder, as air bubbles occur.
Torque wrench (nominal diam. 1/2, 5/8)	×		The size of opposite sides of flare nuts have been increased. Incidentally, a common wrench is used for nominal diameters 1/4 and 3/8.
Flare tool (clutch type)	○		By increasing the clamp bar's receiving hole, strength of spring in the tool has been improved.
Gauge for projection adjustment	—	—	Used when flare is made by using conventional flare tool.
Vacuum pump adapter	○		Connected to conventional vacuum pump. It is necessary to use an adapter to prevent vacuum pump oil from flowing back to the charge hose. The charge hose connecting part has two ports-one for conventional refrigerant (7/16 UNF 20 threads per inch) and one for R410A. If the vacuum pump oil (mineral) mixes with R410A a sludge may occur and damage the equipment.
Gas leakage detector	×		Exclusive for HFC refrigerant.

- Incidentally, the “refrigerant cylinder” comes with the refrigerant designation (R410A) and protector coating in the U. S's ARI specified rose color (ARI color code: PMS 507).
- Also, the “charge port and packing for refrigerant cylinder” require 1/2 UNF 20 threads per inch corresponding to the charge hose's port size.

10-3. Indoor Unit

10-3-1. Installation Place

- A place which provides enough spaces around the indoor unit as shown in the diagram.
- A place where there are no obstacle near the air inlet and outlet.
- A place which allows easy installation of the piping to the outdoor unit.
- A place which allows the front panel to be opened.
- The indoor unit shall be installed so that the top of the indoor unit is positioned at least 2m in height.
- Also, avoid putting anything on the top of the indoor unit.

CAUTION

- Direct sunlight on the indoor unit wireless receiver should be avoided.
- The microprocessor in the indoor unit should not be too close to r-f sources. (For details, see the owner's manual.)

Remote controller

- Should be placed where there are no obstacles, such as curtains, that may block the signal.
- Do not install the remote controller in a place exposed to direct sunlight or close to a heating source, such as a stove.
- Keep the remote controller at least 1 m away from the nearest TV set or stereo equipment. (This is necessary to prevent image disturbances or noise interference.)
- The location of the remote controller should be determined as shown below.

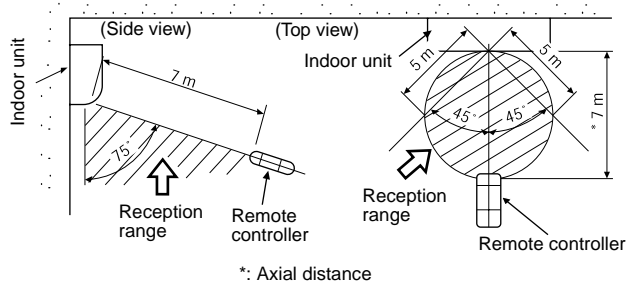

Fig. 10-3-1

10-3-2. Drilling a Hole and Mounting Installation Plate

Drilling a hole

When install the refrigerant pipes from the rear.

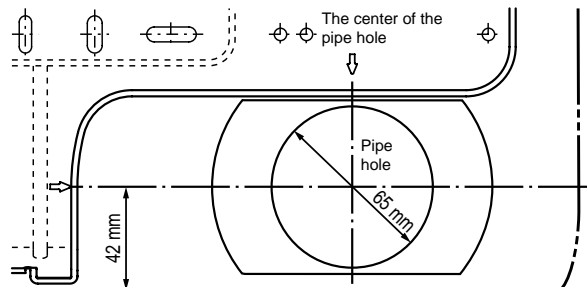

Fig. 10-3-2

1. After determining the pipe hole position on the installation plate (⇨) drill the pipe hole (Ø65 mm) at a slight downward slant to the outdoor side.

NOTE :

- When drilling into a wall that contains a metal lath, wire lath or metal plate, be sure to use a pipe hole brim ring sold separately.

Mounting the installation plate

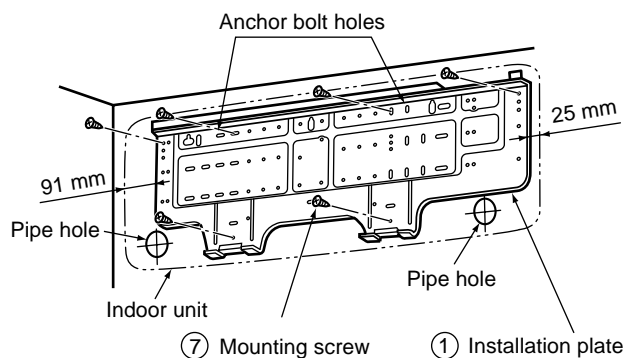

Fig. 10-3-3

When the installation plate is directly mounted on the wall

1. Securely fit the installation plate onto the wall by screws with the upper and lower catches, that hold the indoor unit, facing out.
2. To mount the installation plate on a concrete wall use anchor bolts. Drill the anchor bolt holes as illustrated in the above figure.
3. Install the installation plate horizontally and level.

CAUTION

When installing the installation plate with mounting screw, do not use the anchor bolt hole. Otherwise the unit may fall down and result in personal injury and property damage.

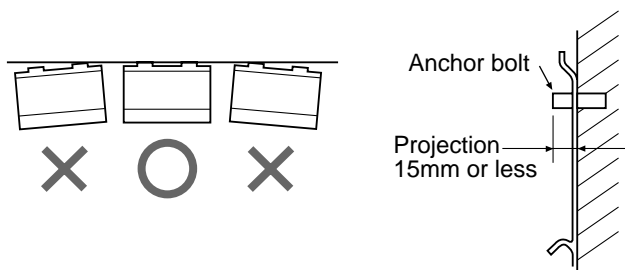

Fig. 10-3-4

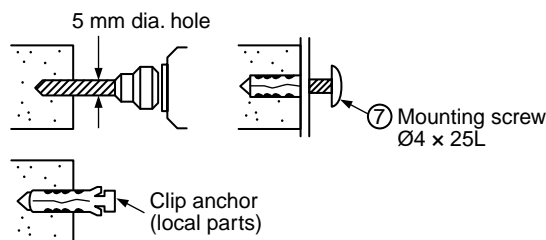

Fig. 10-3-5

CAUTION

Failure to securely install the unit may result in personal injury and/or property damage if the unit falls.

- In case of block, brick, concrete or similar type walls, drill 5 mm dia. holes in the wall.
- Insert clip anchors for the ⑦ mounting screws.

NOTE :

- Install the installation plate using mounting screws between 4 to 6, being sure to secure all four corners.

10-3-3. Electrical Work

1. The supply voltage must be the same as the rated voltage of the air conditioner.
2. Prepare a power source for the exclusive use of the air conditioner.

NOTE :

- Wire type :
More than H07RN-F or 245IEC66 (1.0mm²)

CAUTION

- This appliance can be connected to a main circuit breaker in either of the following two ways.
 1. Connection to fixed wiring:
A switch or circuit breaker which disconnects all poles and has a contact separation of at least 3 mm must be incorporated in the fixed wiring. An approved circuit breaker or switch must be used.
 2. Connection with power supply plug:
Attach power supply plug with power cord and plug it into wall outlet. An approved power supply cord and plug must be used.

NOTE :

- Perform wiring work being sure the wire length is long enough.

10-3-4. Wiring Connection

How to connect the connecting cable

Wiring the connecting cable can be carried out without removing the front panel.

1. Remove the air inlet grille. Open the air inlet grille upward and pull it toward you.
2. Remove the terminal cover and cord clamp.
3. Insert the connecting cable (or as according to local regulations/codes) into the pipe hole on the wall.
4. Pull the connecting cable through the cable slot on the rear panel so that it protrudes about 15 cm out of the front.
5. Insert the connecting cable fully into the terminal block and secure it tightly with screws.
6. Tightening torque: 1.2 N•m (0.12 kgf•m)
7. Secure the connecting cable with the cord clamp.
8. Attach the terminal cover, rear plate bushing and air inlet grille on the indoor unit.

CAUTION

- Be sure to refer to the wiring system diagram labeled inside the front panel.
- Check local electrical regulations for any specific wiring instructions or limitations.

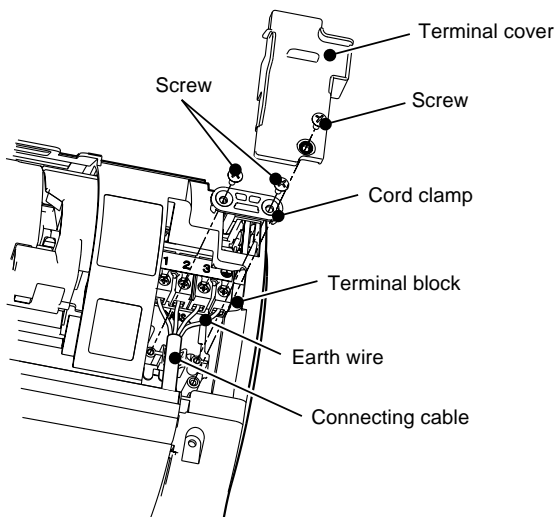

Fig. 10-3-6

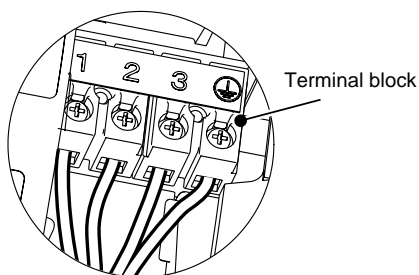

Fig. 10-3-7

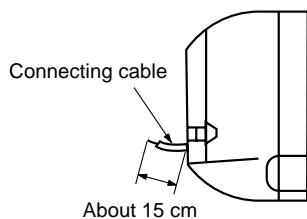

Fig. 10-3-8

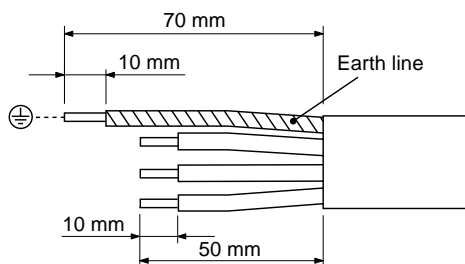

Fig. 10-3-9

NOTE :

WIRE TYPE : more than H07 RN-F or 245 IEC 66.
(1.0mm²)

10-3-5. Piping and Drain Hose Installation

Piping and drain hose forming

- Since condensation results in machine trouble, make sure to insulate both the connecting pipes separately.
(Use polyethylene foam as insulating material.)

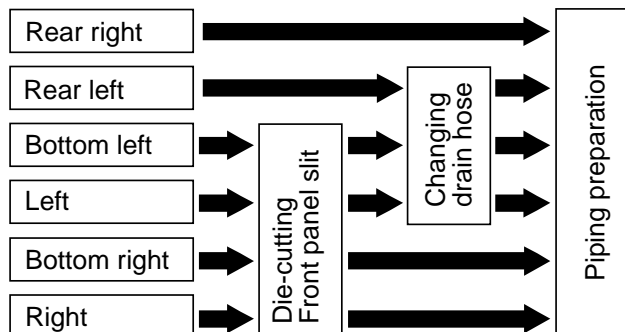

Fig. 10-3-10

1. Die-cutting front panel slit

Cut out the slit on the left or right side of the front panel for the left or right connection and the slit on the bottom left or side of the front panel for the bottom left or right connection with a pair of nippers.

2. Changing drain hose

For left connection, left-bottom connection and rear-left connection's piping, it is necessary to relocate the drain hose and drain cap.

How to remove the drain cap

Clip drain cap with needle-nose pliers, and pull out.

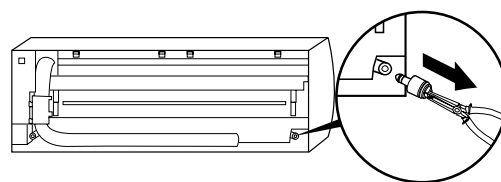

Fig. 10-3-11

How to remove the drain hose

The drain hose is secured in place by a screw. Remove the screw securing the drain hose, then pull out the drain hose.

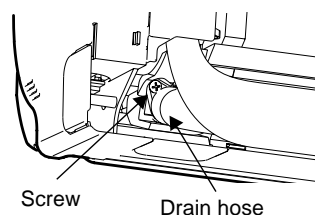

Fig. 10-3-12

How to attach the drain cap

1. Insert hexagonal wrench (4 mm).

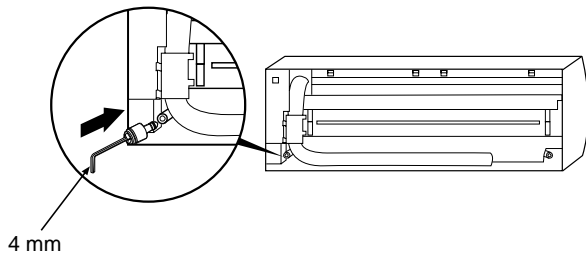

Fig. 10-3-13

2. Firmly insert drain cap.

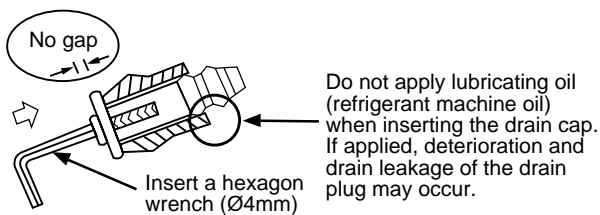

Fig. 10-3-14

How to attach the drain hose

Always use the original screw that secured the drain hose to the unit. If using a different screw may cause water to leak.

Insert the drain hose firmly until the connector contacts with the insulation, then secure it in place using the original screw.

CAUTION

Securely insert the drain hose and drain cap; otherwise, water may leak.

In case of right or left piping

- After making slits on the front panel with a knife or similar tool, cut them out with a pair of nippers or an equivalent tool.

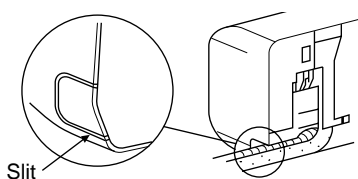

Fig. 10-3-15

In case of bottom right or bottom left piping

- After making slits on the front panel with a knife or similar tool, cut them out with a pair of nippers or an equivalent tool.

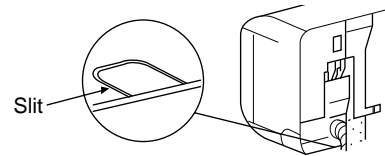

Fig. 10-3-16

Left-hand connection with piping

Bend the connecting pipes so that they are positioned within 43 mm above the wall surface.

If the connecting pipes are positioned more than 43 mm above the wall surface, the indoor unit may be unstable.

When bending the connecting pipe, make sure to use a spring bender to avoid crushing the pipe.

Refer to the table below for the bending radius of each connection pipe.

Outer diameter	Bending radius
6.35 mm	30 mm
9.52 mm	40 mm
12.7 mm	50 mm

To connect the pipe after installation of the unit (figure)

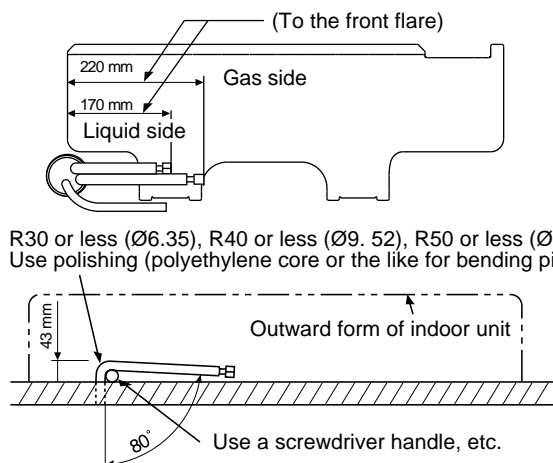

R30 or less (Ø6.35), R40 or less (Ø9.52), R50 or less (Ø12.7)
Use polishing (polyethylene core or the like for bending pipe).

Fig. 10-3-17

NOTE :

If the pipe is incorrectly bent, the indoor unit may be unstable on the wall.

After passing the connecting pipe through the pipe hole, connect the connecting pipe to the auxiliary pipes and wrap the facing tape around them.

CAUTION

- Bind the auxiliary pipes (two) and connecting cable with facing tape tightly.
In case of leftward piping and rear-leftward piping, bind the auxiliary pipes (two) only with facing tape.

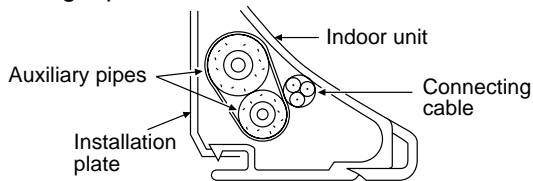

Fig. 10-3-18

- Carefully arrange the pipes so that none of the pipes stick out of the rear plate of the indoor unit.
- Carefully connect the auxiliary pipes and connecting pipes to each other and cut off the insulating tape wound on the connecting pipe to avoid double-taping at the joint, moreover, seal the joint with the vinyl tape, etc.
- Since condensation can result in machine performance trouble, be sure to insulate both connecting pipes. (Use polyethylene foam as insulating material.)
- When bending a pipe, be careful not to crush it.

10-3-6. Indoor Unit Installation

1. Pass the pipe through the hole in the wall, and hook the indoor unit on the installation plate at the upper hooks.
2. Swing the indoor unit to right and left to confirm that it is firmly hooked on the installation plate.
3. While pressing the indoor unit onto the wall, hook it at the lower part on the installation plate. Pull the indoor unit toward you to confirm that it is firmly hooked on the installation plate.

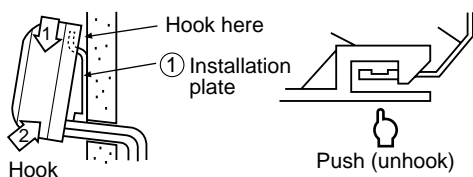

Fig. 10-3-19

- For detaching the indoor unit from the installation plate pull the indoor unit toward you while pushing the bottom up at the specified places.

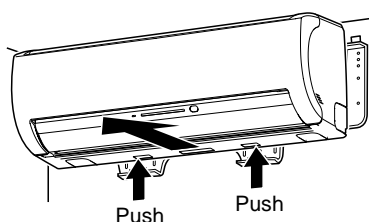

Fig. 10-3-20

10-3-7. Drainage

1. Run the drain hose at a downward sloped angle.

NOTE :

- Hole should be made at a slight downward slant on the outdoor side.

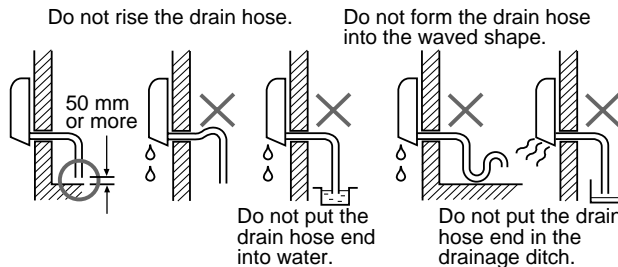

Fig. 10-3-21

2. Put water in the drain pan and make sure that the water is being drained outside.
3. When connecting extension drain hose, insulate the connection part of extension drain hose with shield pipe.

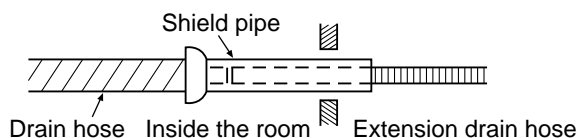

Fig. 10-3-22

CAUTION

Install the drain pipe for proper drainage. Improper drainage can result in water dripping inside the room.

This air conditioner has been designed to drain water collected from condensation which forms on the back of the indoor unit, to the drain pan.

Therefore, do not locate the power cord and other parts at a high place than the drain guide.

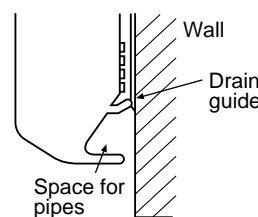



Fig. 10-3-23

10-4. Outdoor Unit

10-4-1. Accessory and Installation Parts

①	 Outdoor unit installation manual × 1
②	 Specifications × 1

10-4-2. Refrigerant Piping

- Piping kit used for the conventional refrigerant cannot be used.
- **Use copper pipe with 0.8 mm or more thickness.**
- Flare nut and flare works are also different from those of the conventional refrigerant. Take out the flare nut attached to the main unit of the air conditioner, and use it.

10-4-3. Installation Place

- A place which provides the spaces around the outdoor unit.
- A place where the operation noise and discharged air do not disturb your neighbors.
- A place which is not exposed to a strong wind.
- A place which does not block a passageway.
- When the outdoor unit is to be installed in an elevated position, be sure to secure its feet.
- There must be sufficient spaces for carrying the unit into and out of the site.
- A place where the drain water does not raise any problem.
- A place which can bear the weight of the outdoor unit and does not allow an increase in noise level and vibration.

CAUTION

1. Install the outdoor unit without anything blocking the air discharging.
2. When the outdoor unit is installed in a place exposed always to a strong wind like a coast or on a high story of a building, secure the normal fan operation using a duct or a wind shield.
3. Especially in windy area, install the unit to prevent the admission of wind.

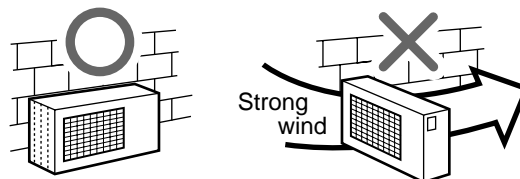

Fig. 10-4-1

4. Installation in the following places may result in trouble. Do not install the unit in such places.
 - A place full of machine oil.
 - A place full of sulfide gas.
 - A place where high-frequency waves are likely to be generated as from audio equipment, welders, and medical equipment.
 - A saline-place such as a coast.

10-4-4. Optional Installation Parts (Local Supply)

	Parts name	Q'ty
A	Refrigerant piping Liquid side : Ø6.35 mm Gas side : Ø9.52 mm or Ø12.7 mm	Each one
B	Pipe insulating material (polyethylene foam, 6 mm thick)	1
C	Putty, PVC tapes	Each one

10-4-5. Refrigerant Piping Connection

CAUTION

KEEP IMPORTANT 4 POINTS FOR PIPING WORK

1. Keep dust and moisture from entering the pipes.
2. Tight connection (between pipes and unit)
3. Evacuate the air in the connecting pipes using VACUUM PUMP.
4. Check gas leak. (connected points)

Flaring

1. Cut the pipe with a pipe cutter.

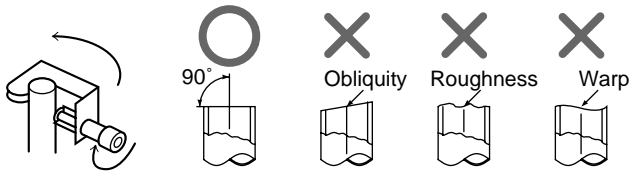
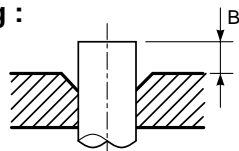

Fig. 10-4-2

2. Insert a flare nut into the pipe, and flare the pipe.
As the flaring sizes of R410A differ from those of refrigerant R22, the flare tools newly manufactured for R410A are recommended.
However, the conventional tools can be used by adjusting projection margin of the copper pipe.

- Projection margin in flaring :
B (Unit : mm)



Rigid (Clutch type)

Fig. 10-4-3

Outer dia. of copper pipe	R410A tool used		Conventional tool used	
	R410A	R22	R410A	R22
6.35	0 to 0.5	(Same as left)	1.0 to 1.5	0.5 to 1.0
9.52	0 to 0.5	(Same as left)	1.0 to 1.5	0.5 to 1.0
12.7	0 to 0.5	(Same as left)	1.0 to 1.5	0.5 to 1.0

Imperial (Wing nut type)

Outer dia. of copper pipe	R410A	R22
6.35	1.5 to 2.0	1.0 to 1.5
9.52	1.5 to 2.0	1.0 to 1.5
12.7	2.0 to 2.5	1.5 to 2.0

- Flaring size : A (Unit : mm)

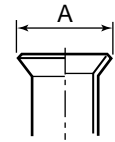

Fig. 10-4-4

Outer dia. of copper pipe	A $\begin{matrix} +0 \\ -0.4 \end{matrix}$	
	R410A	R22
6.35	9.1	9.0
9.52	13.2	13.0
12.7	16.6	16.2

* In the case of flaring for R410A with the conventional flare tool, pull out it approx. 0.5 mm more than that for R22 to adjust to the specified flare size. The copper pipe gauge is useful for adjusting projection margin size.

10-4-6. Installation

NOTE : For installation, at least 3 dimensions should be kept free from obstacles (walls).

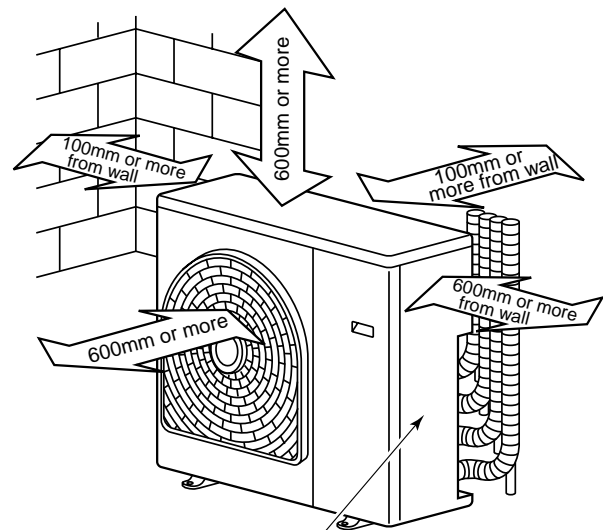

As shown in the figure, hang power cord and connecting cable downward, and take out it along piping connection port.

Fig. 10-4-5

Fixing bolt arrangement of outdoor unit

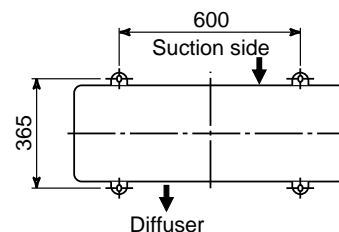

Fig. 10-4-6

- Secure the outdoor unit with the fixing bolts and nuts if the unit is likely to be exposed to a strong wind.
- Use Ø8 mm or Ø10 mm anchor bolts and nuts.

- Piping connections to the outdoor unit should be arranged in the sequence A, B, C, D starting from the bottom.
(For each piping connection, the gas pipe is on the bottom and the liquid pipe is on the top.)
- When multiple indoor units are to be connected to the outdoor unit, make the ends of the pipes and wires from each indoor unit to ensure that they will be connected to the outdoor unit correctly.
(Problems caused by indoor units being connected to the outdoor unit incorrectly are very common in multiple-unit installations.)
- The length and height difference of the connecting pipes between the indoor and outdoor units must be within the ranges indicated below.
 - Total piping length :
4 units (A + B + C + D) Multi,
Non. Additional refrigerant 70 m
3 units (A + B + C) Multi,
Non. Additional refrigerant 50 m
 - Minimum piping length :
A or B or C or D = 2 m or more
 - Maximum indoor piping length :
A or B or C or D = 25 m or less
 - Maximum piping height difference :
A or B or C or D = 15 m or less
 - Maximum piping/height difference between 2 units = 15 m or less

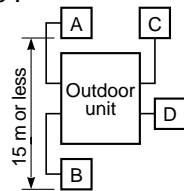

Fig. 10-4-7

- Connect 2 or more indoor units for heat pump.
- If the outdoor unit is to be mounted on a wall, make sure that the platform supporting it is sufficiently strong. The platform should be designed and manufactured to maintain its strength over a long period of time, and sufficient consideration should be given to ensuring that the outdoor unit will not fall.
- When the outdoor unit is to be mounted high on a wall, take particular care to ensure that parts do not fall installer is protected.
- When doing installation work on level ground, it is usual to wiring and piping connections to the indoor units. And/then make to the outdoor unit. However if outdoor work is difficult it is possible instead to make changes to the procedure. For example by making adjustments to the wiring and piping length on the inside (rather than the outside).

How to remove the side panel

- Remove 3 screws of the side panel.
- Pull the side panel downward.

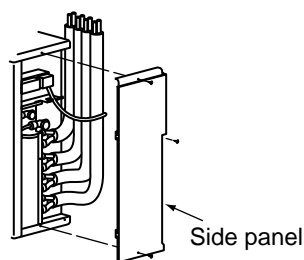

Fig. 10-4-8

Tightening connection

Align the centers of the connecting pipes and tighten the flare nut as far as possible with your fingers. Then tighten the nut with a spanner and torque wrench as shown in the figure.

CAUTION

- Do not apply excess torque. Otherwise, the nut may break.

(Unit : N·m)

Outer dia. of copper pipe	Tightening torque
Ø6.35 mm	14 to 18 (1.4 to 1.8 kgf·m)
Ø9.52 mm	33 to 42 (3.3 to 4.2 kgf·m)
Ø12.7 mm	50 to 62 (5.0 to 6.2 kgf·m)

Tightening torque of flare pipe

The pressure of R410A is higher than R22. (Approx. 1.6 times) Therefore securely tighten the flare pipes which connect the outdoor unit and indoor unit with the specified tightening torque using a torque wrench.

If any flare pipe is incorrectly connected, it may cause not only a gas leakage but also trouble in the refrigeration cycle.

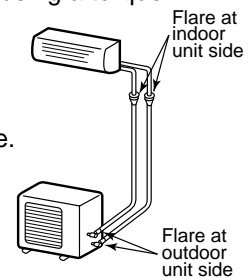

Fig. 10-4-9

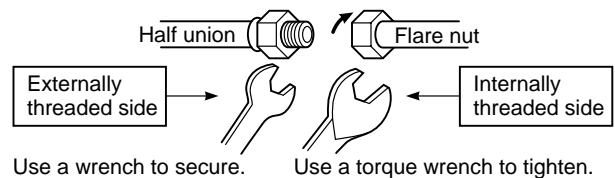

Fig. 10-4-10

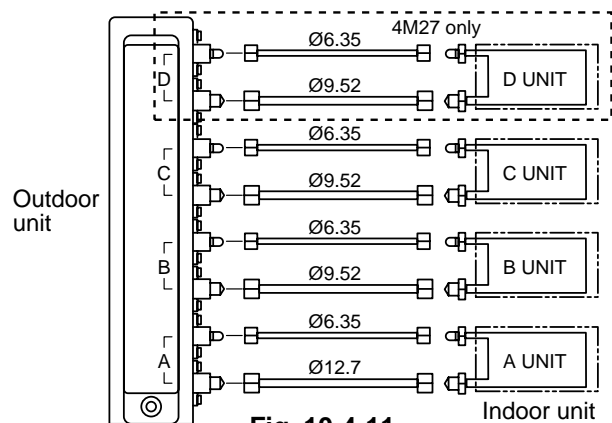

Fig. 10-4-11

	Connectable capacity class				Total
	A	B	C	D	
3M26	10, 13 (with reducer)	16 (with expander)	16 (with expander)	—	45
	16	10, 13	10, 13	—	
4M27	10, 13 (with reducer)	16 (with expander)	16 (with expander)	16 (with expander)	52
	16	10, 13	10, 13	10, 13	

10-4-7. Evacuating

After the piping has been connected to all indoor unit(s), you can perform the air purge together at once.

AIR PURGE

Evacuate the air in the connecting pipes and in the indoor unit using vacuum pump.

Do not use the refrigerant in the outdoor unit.

For details, see the manual of vacuum pump.

Use a vacuum pump

Be sure to use a vacuum pump with counter-flow prevention function so that inside oil of the pump does not flow backward into pipes of the air conditioner when the pump stops.

(If inside oil of the vacuum pump enters into the air conditioner which adopts R410A, a trouble of the refrigeration cycle may be caused.)

1. Connect the charge hose from the manifold valve to the service port of the gas side packed valve.
2. Connect the charge hose to the port of vacuum pump.
3. Open fully the low pressure side handle of the gauge manifold valve.
4. Operate the vacuum pump to start for evacuating. Perform evacuating for about 35 minutes if the piping length is total 70 meters. (25 minutes for total 50 meters) (assuming a pump capacity of 27 liters per minute.)

Then confirm that the compound pressure gauge reading is -101 kPa (-76 cmHg).

5. Close the low pressure side valve handle of gauge manifold.
6. Open fully the valve stem of the packed valves (both sides of Gas and Liquid).
7. Remove the charging hose from the service port.
8. Securely tighten the caps on the packed valves.

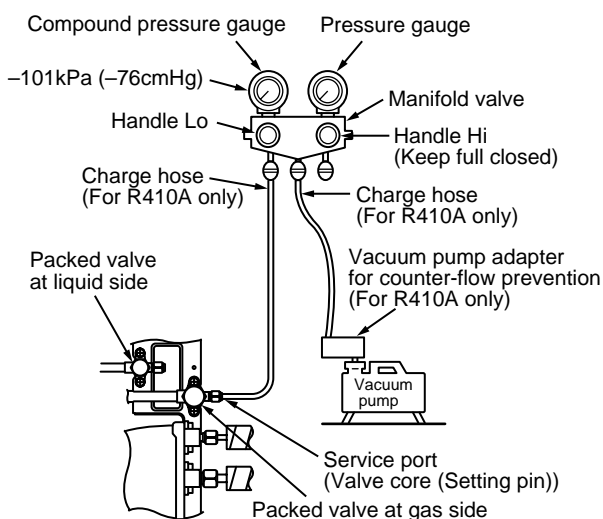

Fig. 10-4-12

Packed valve handling precautions

- Open the valve stem all the way out ; do not try to open it beyond the stopper.
- Securely tighten the valve stem cap in torque is as follows :

Gas side (Ø12.7 mm)	50 to 62 N•m (5.0 to 6.2 kgf•m)
Gas side (Ø9.52 mm)	33 to 42 N•m (3.3 to 4.2 kgf•m)
Liquid side (Ø6.35 mm)	14 to 18 N•m (1.4 to 1.8 kgf•m)
Service port	14 to 18 N•m (1.4 to 1.8 kgf•m)

Hexagonal wrench is required.

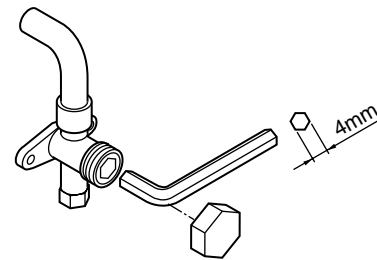

Fig. 10-4-13

10-4-8. Electrical Work

For the air conditioner that has no power cord, connect a power cord to it as mentioned below.

Model	3 Units Multi		4 Units Multi	
	3M26GAV-E	4M27GAV-E	4M27GACV-E	
Power supply	220 – 240 V ~50 Hz 240 V ~60 Hz			
Maximum running current	15.3 A	15.3 A	14.8 A	
Installation fuse rating	25 A			
Power cord	H07 RN-F or 245 IEC 66 (2.5 mm ² or more)			

Wiring connection

1. Remove the side panel and cord clamp from the outdoor unit.
2. Connect the connecting cable to the terminal as identified by the matching numbers on the terminal block of indoor and outdoor unit.
3. Insert the power cord and the connecting cable fully into the terminal block and secure it tightly with screws.
4. Insulate the unused cords (conductors) from water entering in the outdoor unit. Locate them so that they do not touch any electrical or metal parts.
5. Secure the power cord and the connecting cable with the cord clamp.
6. Attach the side panel on the outdoor unit.

3 units (A + B + C) Multi

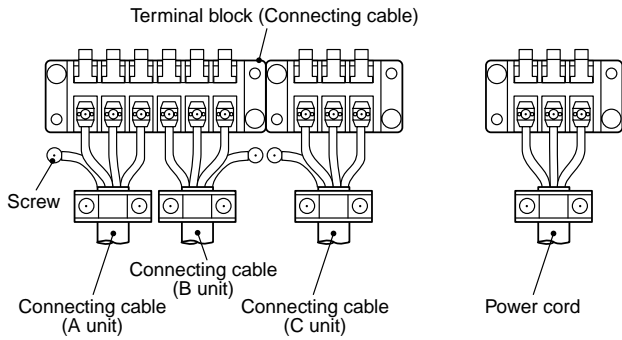

Fig. 10-4-14

4 units (A + B + C + D) Multi

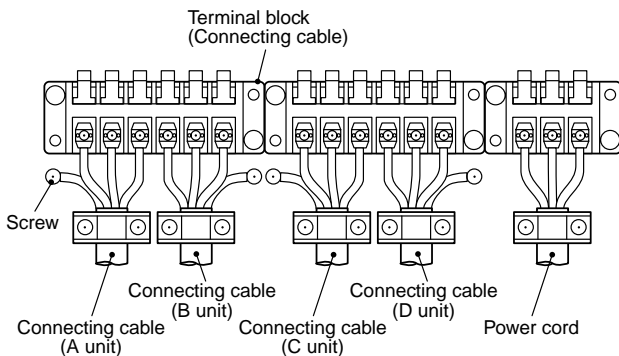

Fig.10-4-15

CAUTION

- Wrong wiring connection may cause some electrical parts burn out.
- Be sure to use the cord clamps specified positions with attached to the product.
- Do not damage or scratch the conductive core and inner insulator of power and inter-connecting cables when peeling them.
- Be sure to comply with local cords on running the wire from outdoor unit to indoor unit (size of wire and wiring method etc.)
- Use the power cord and Inter-connecting cable with specified thickness, specified type, and protective devices specified.

Stripping length power cord and connecting cable

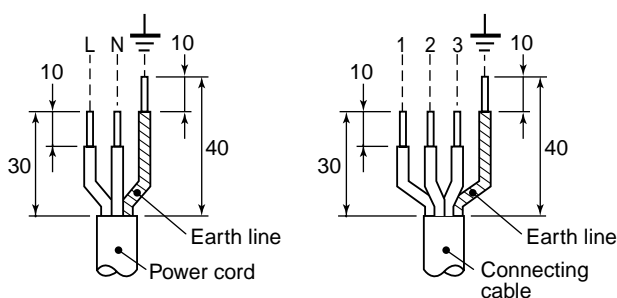
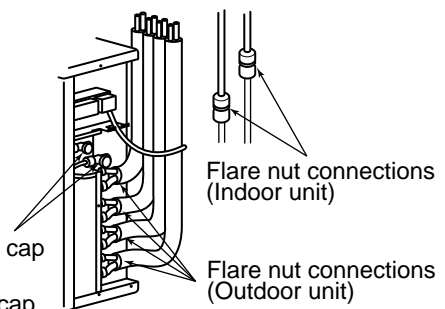

Fig. 10-4-16

10-4-9. Check and Test Operation

For R410A, use the leak detector exclusively manufactured for HFC refrigerant (R410A, R134a, etc.).

- * The conventional leak detector for HCFC refrigerant (R22, etc.) cannot be used because its sensitivity for HFC refrigerant lowers to approx. 1/40.
- Pressure of R410A becomes approx. 1.6 times of that of R22. If installation work is incompletely finished, a gas leakage may occur in the cases such as pressure rise during operation. Therefore, be sure to test the piping connections for leaking.



- Service port cap connection
- Valve stem cap connection

Fig. 10-4-17

- Check the flare nut connections, valve stem cap connections and service port cap connections for gas leak with a leak detector or soap water.

CAUTION

- Use a circuit breaker of a type that is not tripped by shock waves.
- If incorrect/incomplete wiring is carried out, it will cause an electrical fire or smoke.
- Prepare the power supply for exclusive use with the air conditioner.
- This product can be connected to the mains.

Connection to fixed wiring :

A switch or circuit breaker which disconnects all poles and has a contact separation of at least 3 mm must be incorporate in the fixed wiring.

An approved short circuit breaker or switches must be used.

* (A breaker having a sensitivity of approximately 0.1 second or less and a capacity of approximately 30 mA is usually used.)

10-4-10. Miswiring (Mispiping) Check

Make sure that the wiring and piping for each room have the same alphabetical codes (A, B, C, D).

Connect and secure the power cord.

Use the power cord/cables with thickness, type and protective devices specified in this manual.

Insulate the unused cords (conductors) with PVC tape.

1. Turn on the power breaker.
2. Open side panel of the outdoor unit.
3. Set the all indoor units to COOL mode.
 - It is unnecessary to set the temperature.
 - Miswiring check can not be executed when outdoor air temperature is 5°C or less.
4. Start the check.
 - Disconnect the miswiring check connector (color : Red) from P.C. board of inverter.

5. During check (Check time 3 to 20 minutes).
 - When an error describes in the table below occurred check operation stops and error code is displayed on LED.
6. After check, the result of check is displayed on LED.
 - The Comp. stop when miswiring (mispiping) error occurred.
 - Confirm the contents of table below.
 - Turn off the power breaker.
 - Correct miswiring/mispiping.
 - Execute the check operation again.
 - Automatically return to the normal operation when it is normal.
7. Return to normal operation.
 - To return to the normal operation during check operation or after miswiring (mispiping) error is determined, connect the miswiring check connector.

Miswiring (mispiping) check by LED Indication

- For this outdoor unit, the self-miswiring (mispiping) check is possible by using five LEDs (1 Yellow + 4 Red).
- * LEDs (D800 to D804) locate on the sub-control board underneath of the inverter.

LED	D800	D801	D802	D803	D804	Description
	●	●	●	●	●	Normal operation (no error)
During check	◎	◎	●	●	●	Checking A unit
	◎	●	◎	●	●	Checking B unit
	◎	●	●	◎	●	Checking C unit
	*1 ◎	●	●	●	◎	Checking D unit
Result of judgement	◎	☒	●	●	●	Crush/Clog of Pipe A
	◎	●	☒	●	●	Crush/Clog of Pipe B
	◎	●	●	☒	●	Crush/Clog of Pipe C
	*1 ◎	●	●	●	☒	Crush/Clog of Pipe D
	◎	☒	☒	●	●	Miswiring/Mispiping or Crush/Clog of Pipe A, B
	*1 ◎	☒	●	☒	●	Miswiring/Mispiping or Crush/Clog of Pipe A, C
	*1 ◎	☒	●	●	☒	Miswiring/Mispiping or Crush/Clog of Pipe A, D
	*1 ◎	●	☒	☒	●	Miswiring/Mispiping or Crush/Clog of Pipe B, C
	*1 ◎	●	☒	●	☒	Miswiring/Mispiping or Crush/Clog of Pipe B, D
	*1 ◎	●	●	☒	☒	Miswiring/Mispiping or Crush/Clog of Pipe C, D
	◎	☒	☒	☒	●	A, B, C Miswiring/Mispiping
	◎	☒	☒	●	☒	A, B, D Miswiring/Mispiping
	◎	☒	●	☒	☒	A, C, D Miswiring/Mispiping
◎	●	☒	☒	☒	B, C, D Miswiring/Mispiping	
◎	☒	☒	☒	☒	A, B, C, D Miswiring/Mispiping packed valve keeps closed	

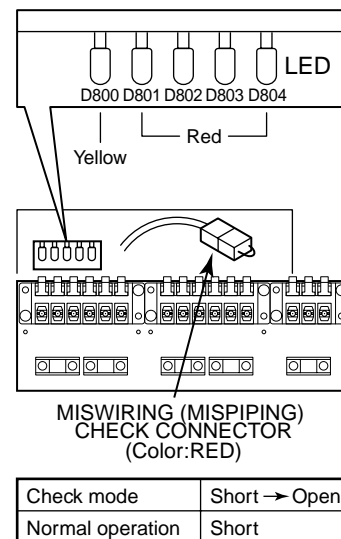

Fig. 10-4-18

LED : Light Emitting Diode

☒ : LED ON

● : LED OFF

◎ : LED FLASH

*1 : 4 units Multi model only

Useful Functions

Self-Diagnosis by LED Indication

- For this outdoor unit, the self-diagnosis is possible by using five LEDs (1 Yellow + 4 Red).
- * LEDs (D800 to D804) are provided on P.C. board of the inverter.

LED indication					Indoor	Contents
D800	D801	D802	D803	D804	alarm code	
●	●	●	●	●	None	Normal running
●	□	●	●	●	14	IGBT short circuit, Compressor motor rare short
□	□	●	●	●	16	Trouble on position detecting circuit
●	●	□	●	●	17	Trouble on current detecting circuit
*2	□	●	□	●	18	Outdoor heat exchanger temp. sensor (TE) fault
*2	●	●	□	●	18	Suction temp. sensor (TS) fault
●	□	□	●	●	19	Discharge temp. sensor (TD) fault
□	□	□	●	●	1A	Trouble on outdoor fan motor
●	●	●	□	●	1B	Outdoor temp. sensor (TO) fault
□	●	□	●	●	1C	Trouble on compressor system
□	□	□	□	●	1C	Temp. sensor (TGa) fault at A room gas side
□	●	●	●	□	1C	Temp. sensor (TGb) fault at B room gas side
□	□	●	●	□	1C	Temp. sensor (TGc) fault at C room gas side
*1	●	●	●	□	1C	Temp. sensor (TGd) fault at D room gas side
●	□	□	●	□	1C	Gas leakage, TS sensor out of place, PMV, sensor fault
□	□	□	●	□	1C	TE sensor out of place, indoor heat exchanger sensor (TC) out of place, PMV, sensor fault
●	●	●	□	□	1C	Miswiring at indoor or outdoor, Gas leakage, TS, TC sensor out of place, PMV, sensor fault
□	□	●	□	□	1C	Communication trouble between MCU
□	●	●	□	●	1D	Compressor lock
●	□	●	□	●	1E	Trouble on discharge temp, Gas leakage
□	□	●	□	●	1F	Compressor break down

1. If a trouble occurs, LED goes on according to the contents of trouble as shown in the left table.
2. When two or more troubles occur, LEDs go on cyclically (alternately).
3. Usually, LEDs (Red) go off.

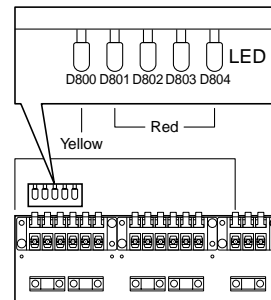

Fig. 10-4-19

IGBT : Insulated Gate Bipolar Transistor
 PMV : Pulse Motor Valve
 LED : Light Emitting Diode
 □ : LED ON (Yellow)
 ● : LED OFF (Red)
 *1 : 4 units Multi model only
 *2 : Heat pump model only

Installation/Serviceing Tools

Changes in the product and components

In the case of an air conditioner using R410A, in order to prevent any other refrigerant from being charged accidentally, a service port diameter of the outdoor unit control valve (3 way valve) has been changed. (1/2 UNF 20 threads per inch)

- In order to increase the pressure resisting strength of the refrigerant piping flare processing diameter and size of opposite side of flare nuts is changed. (for copper pipes with nominal dimensions 1/2 and 5/8)

New tools for R410A

New tools for R410A	Applicable to R22 model	Changes
Gauge manifold	×	As pressure is high, it is impossible to measure by means of conventional gauge. In order to prevent any other refrigerant from being charged, each port diameter is changed.
Charge hose	×	In order to increase pressure resisting strength, hose materials and port size are changed (to 1/2 UNF 20 threads per inch). When purchasing a charge hose, be sure to confirm the port size.
Electronic balance for refrigerant charging	○	As pressure is high and gasification speed is fast, it is difficult to read the indicated value by means of charging cylinder, as air bubbles occur.
Torque wrench (nominal diam. 1/2, 5/8)	×	The size of opposite sides of flare nuts have been increased. Incidentally, a common wrench is used for nominal diameters 1/4 and 3/8.
Flare tool (clutch type)	○	By increasing the clamp bar's receiving hole, strength of spring in the tool has been improved.
Gauge for projection adjustment	—	—
Vacuum pump adapter	○	Connected to conventional vacuum pump. It is necessary to use an adapter to prevent vacuum pump oil from flowing back to the charge hose. The charge hose connecting part has two ports-one for conventional refrigerant (7/16 UNF 20 threads per inch) and one for R410A. If the vacuum pump oil (mineral) mixes with R410A a sludge may occur and damage the equipment.
Gas leakage detector	×	Exclusive for HFC refrigerant.

- Incidentally, the "refrigerant cylinder" comes with the refrigerant designation (R410A) and protector coating in the U. S.'s ARI specified rose color (ARI color code: PMS 507).
- Also, the "charge port and packing for refrigerant cylinder" require 1/2 UNF 20 threads per inch corresponding to the charge hose's port size.

11. HOW TO DIAGNOSE THE TROUBLE

The pulse modulating circuits are mounted to both indoor and outdoor units.

Therefore, diagnose troubles according to the trouble diagnosis procedure as described below.

(Refer to the check points in servicing written on the wiring diagrams attached to the indoor/outdoor units.)

Table 11-1

No.	Troubleshooting Procedure	Page
1	First Confirmation	88
2	Primary Judgment	88
3	Self-Diagnosis by Remote Controller (Check Code)	89
4	Judgment of Trouble by Every Symptom	92
5	Trouble Diagnosis by Outdoor LED	97
6	How to Diagnose Trouble in Outdoor Unit	100
7	How to Check Simply the Main Parts	101
8	How to Simply Judge Whether Outdoor Fan Motor is Good or Bad	106

NOTE :

A large-capacity electrolytic capacitor is used in the outdoor unit controller (inverter). Therefore, if the power supply is turned off, charge (charging voltage DC280V) remains and discharging takes a lot of time. After turning off the power source, if touching the charging section before discharging, an electrical shock may be caused. Discharge the electrolytic capacitor completely by using soldering iron, etc.

< Discharging method >

1. Remove the inverter cover (plating) by opening four mounting claws.
2. As shown below, connect the discharge resistance (approx. 100W/40W) or plug of the soldering iron to voltage between + – terminals of the C13 ("CAUTION HIGH VOLTAGE 320V" is indicated.) electrolytic capacitor (760 μ F/400V) on P.C. board, and then perform discharging.

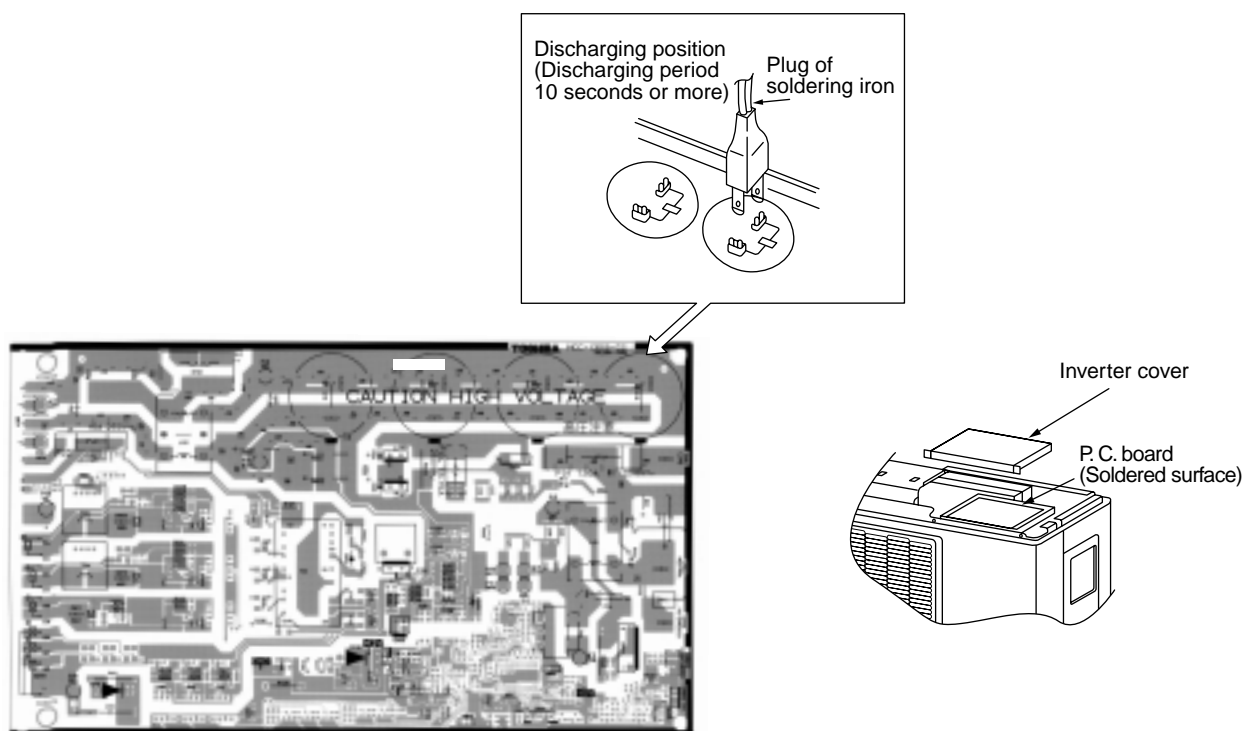

Fig. 11-1

11-1. First Confirmation

11-1-1. Confirmation of Power Supply

Confirm that the power breaker operates (ON) normally.

11-1-2. Confirmation of Power Voltage

Confirm that power voltage is AC 220–240 ±10%. If power voltage is not in this range, the unit may not operate normally.

11-1-3. Operation Which is not a Trouble (Program Operation)

For controlling the air conditioner, the program operations are built in the microcomputer as described in the following table. If a claim is made for running operation, check whether or not it meets to the contents in the following table. When it does, we inform you that it is not trouble of equipment, but it is indispensable for controlling and maintaining of air conditioner.

Table 11-1-1

No.	Operation of air conditioner	Description
1	When power breaker is turned "ON", the operation lamp (Green) of the indoor unit flashes.	The OPERATION lamp of the indoor unit flashes when power source is turned on. If "START/STOP" button is operated once, flashing stops. (Flashes also in power failure)
2	Compressor may not operate even if the room temperature is within range of compressor-ON.	The compressor does not operate while compressor restart delay timer (3-minutes timer) operates. The same phenomenon is found after power source has been turned on because 3-minutes timer operates.
3	In DRY and ECONO. mode, FAN (air flow) display does not change even though FAN (air flow select) button is operated.	The air flow indication is fixed to [AUTO].
4	Increasing of compressor motor speed stops approx. 30 seconds after operation started, and then compressor motor speed increases again approx. 30 seconds after.	For smooth operation of the compressor, the compressor motor speed is restricted to Max. 33 rps for 2 minutes and Max. 57 rps for 2 minutes to 4 minutes, respectively after the operation has started.
5	The set value of the remote control should be below the room temperature.	If the set value is above the room temperature, Cooling operation is not performed. And check whether battery of the remote control is consumed or not.
6	In AUTO mode, the operation mode is changed.	After selecting Cool or Heat mode, select an operation mode again if the compressor keeps stop status for 15 minutes.
7	In HEAT mode, the compressor motor speed does not increase up to the maximum speed or decreases before the temperature arrives at the set temperature.	The compressor motor speed may decrease by high-temp. release control (Release protective operation by temp.-up of the indoor heat exchanger) or current release control.
8	Cool, Dry, or Heat operation cannot be performed.	When the unit in other room operates previously in different mode, Fan Only operation is performed because of first-push priority control. (Cool operation and Dry operation can be concurrently performed.)

11-2. Primary Judgment

To diagnose the troubles, use the following methods.

- (1) Judgment by flashing LED of indoor unit
- (2) Self-diagnosis by service check remote controller
- (3) Judgment of trouble by every symptom

Firstly use the method (1) for diagnosis. Then, use the method (2) or (3) to diagnose the details of troubles.

For any trouble occurred at the outdoor unit side, detailed diagnosis is possible by 5-serial LED on the inverter P.C. board.

11-3. Self-Diagnosis by Remote Controller (Check Code)

1. If the lamps are indicated as shown B to E in Table 11-3-1, execute the self-diagnosis by the remote controller.
2. When the remote controller is set to the service mode, the indoor controller diagnoses the operation condition and indicates the information of the self-diagnosis on the display of the remote controller with the check codes. If a fault is detected, all lamps on the indoor unit will flash at 5Hz and it will beep for 10 seconds (Beep, Beep, Beep ...). The timer lamp usually flashes (5Hz) during self-diagnosis.

11-3-1. How to Use Remote Controller in Service Mode

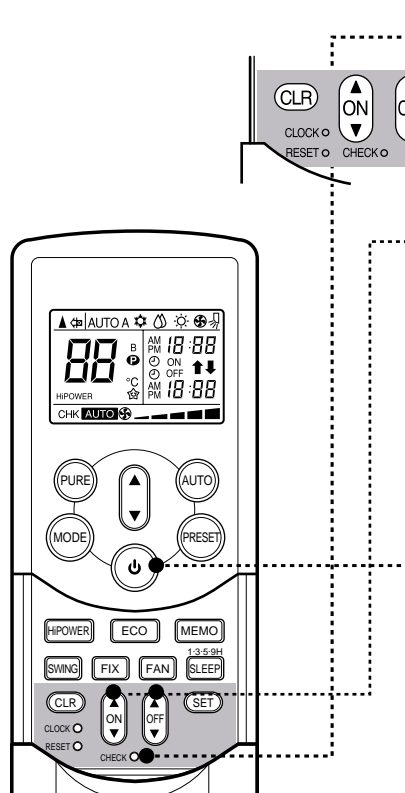

1

Press [CHECK] button with a tip of pencil to set the remote controller to the service mode.

- “00” is indicated on the display of the remote controller.

2

Press [ON ▲] or [OFF ▼] button

If there is no fault with a code, the indoor unit will beep once (Beep) and the display of the remote controller will change as follows :

00 → 01 → 02 ... 1d → 1E → 33

- The TIMER indicator of the indoor unit flashes continuously. (5 times per 1 sec.)
- Check the unit with all 52 check codes (00 to 33) as shown in Table-11-3-1.
- Press [ON ▲] or [OFF ▼] button to change the check code backward.

If there is a fault, the indoor unit will beep for 10 seconds (Beep, Beep, Beep ...).

Note the check code on the display of the remote controller.

- 2-digits alphanumeric will be indicated on the display.
- All indicators on the indoor unit will flash. (5 times per 1 sec.)

3

Press [START/STOP] button to release the service mode.

- The display of the remote controller returns to as it was before service mode was engaged.

4

Time shortening method.

1. Press SET button while pushing CHECK button.
2. Press [START/STOP] button.

Alphanumeric characters are used for the check codes.

5 is 5.	6 is 6.
A is A.	B is B.
C is C.	D is D.

Fig. 11-3-1

11-3-2. Caution at Servicing

1. After servicing, press the START/STOP button to return to the normal mode.
2. After servicing by the check code, turn off breaker of the power supply, and turn on breaker of the power supply again so that memory in the microcomputer returns the initial status.
However, the check codes are not deleted even if the power supply is turned off because they are stored in the fixed memory.
3. After servicing, press [CLR] button under check mode status and then send the check code "7F" to the indoor unit. The error code stored in memory is cleared.

Table 11-3-1

Block distinction		Operation of diagnosis function				Judgment and action
Check code	Block	Check code	Cause of operation	Air conditioner status	Remarks	
00	Indoor P.C. board etc.	01	Short-circuit or disconnection of the room temperature sensor (TA sensor).	Operation continues.	Displayed when error is detected.	1. Check the room temp. sensor. 2. When the room temp. sensor is normal, check P.C. board.
		02	Being out of place, disconnection, short-circuit, or migration of heat exchanger sensor (TC sensor)	Operation continues.	Displayed when error is detected.	1. Check heat exchanger sensor. 2. When heat exchanger sensor is normal, check P.C. board.
		11	Lock of indoor fan or trouble on the indoor fan circuit	All off	Displayed when error is detected.	1. Check the motor. 2. When the motor is normal, check P.C. board.
	Not displayed	12	Trouble on other indoor P.C. boards	Operation continues.	Displayed when error is detected.	Replace P.C. board.
01	Connecting cable and serial signal	04	Return serial signal is not sent to indoor side from operation started. 1) Defective wiring of connecting cable 2) Operation of compressor thermo Gas shortage Gas leak	Operation continues.	Flashes when trouble is detected on Return serial signal, and normal status when signal is reset.	1. When the outdoor unit never operate: 1) Check connecting cable, and correct if defective wiring. 2) Check 25A fuse of inverter P.C. board. 3) Check 3.15A of inverter P.C. board. 2. To display [Other] block during operation, check compressor thermo. operation and supply gas (check gas leak also). 3. Unit operates normally during check. If return serial signal does not stop between indoor terminal board 2 and 3, replace inverter P.C. board. If signal stops between indoor terminal board 2 and 3, replace indoor P.C. board.

Block distinction		Operation of diagnosis function				Judgment and action
Check code	Block	Check code	Cause of operation	Air conditioner status	Remarks	
02	Outdoor P.C. board	14	Inverter over-current protective circuit operates. (Short time)	All off	Displayed when error is detected.	Even if trying operation again, all operations stop immediately. : Replace P.C. board.
		15	Position-detect circuit error or short-circuit between windings of compressor	All off	Displayed when error is detected.	1. Even if connecting lead wire of compressor is removed, position-detect circuit error occurred. : Replace P.C. board. 2. Measure resistance between wires of compressor, and perform short-circuit. : Replace compressor.
		17	Current-detect circuit error	All off	Displayed when error is detected.	Even if trying operation again, all operations stop immediately. : Replace P.C. board.
		18	Being out of place, disconnection or short-circuit of the outdoor temp. sensor (Ts)	All off	Displayed when error is detected.	Check 5-serial LED. 1. Check sensors (TE, TS). 2. Check P.C. board.
		19	Disconnection or short-circuit of discharge temp. sensor	All off	Displayed when error is detected.	1. Check discharge temp. sensor (TD). 2. Check P.C. board
	1A	Outdoor fan drive system error	All off	Displayed when error is detected.	Position-detect error, over-current protective operation of outdoor fan drive system, fan lock, etc. : Replace P.C. board or fan motor.	
	Not displayed	1b	Outdoor temp. sensor error	Operation continues	—	1. Check outdoor temp. sensor (TO). 2. Check P.C. board.
Outdoor P.C. board	1c	Compressor drive output error, Compressor error (lock, missing, etc.), Break down	All off	Displayed when error is detected.	Check 5-serial LED. When 20 seconds passed after start-up, position-detect circuit error occurred. : Replace compressor. Trouble on P.M.V.	
03	Others (including compressor)	07	Return serial signal has been sent when operation started, but it is not sent from halfway. 1) Compressor thermo. operation Gas shortage Gas leak 2) Instantaneous power failure	Operation continues	Flashes when trouble is detected on return serial signal, and normal status when signal is reset.	1. Repeat Start and Stop with interval of approx. 10 to 40 minutes. (Code is not displayed during operation.) Supply gas. (Check also gas leak). 2. Unit operates normally during check. If return serial signal does not stop between indoor terminal block 2 and 3, replace inverter P.C. board. If signal stops between indoor terminal block 2 and 3, replace indoor P.C. board.
		1d	Compressor does not rotate. (Current protective circuit does not operate when a specified time passed after compressor had been activated.)	All off	Displayed when error is detected.	1. Trouble on compressor 2. Trouble on wiring of compressor (Missed phase)
		1E	Discharge temp. exceeded 117°C	All off	Displayed when error is detected.	1. Check discharge temp. sensor (TD). 2. Gas leakage 3. Trouble on P.M.V.
		1F	Break down of compressor	All off	Displayed when error is detected.	1. Check power voltage. (220–230–240 V +10%) 2. Overload operation of refrigeration cycle Check installation condition (Short-circuit of outdoor diffuser).

11-4. Judgment of Trouble by Every Symptom

11-4-1. Indoor Unit (Including Remote Controller)

(1) Power is not turned on (Does not operate entirely)

<Primary check>

1. Is the supply voltage normal?
2. Is the normal voltage provided to the outdoor unit?
3. Is the crossover cable connected properly?
4. Is the fuse (F01) blown?

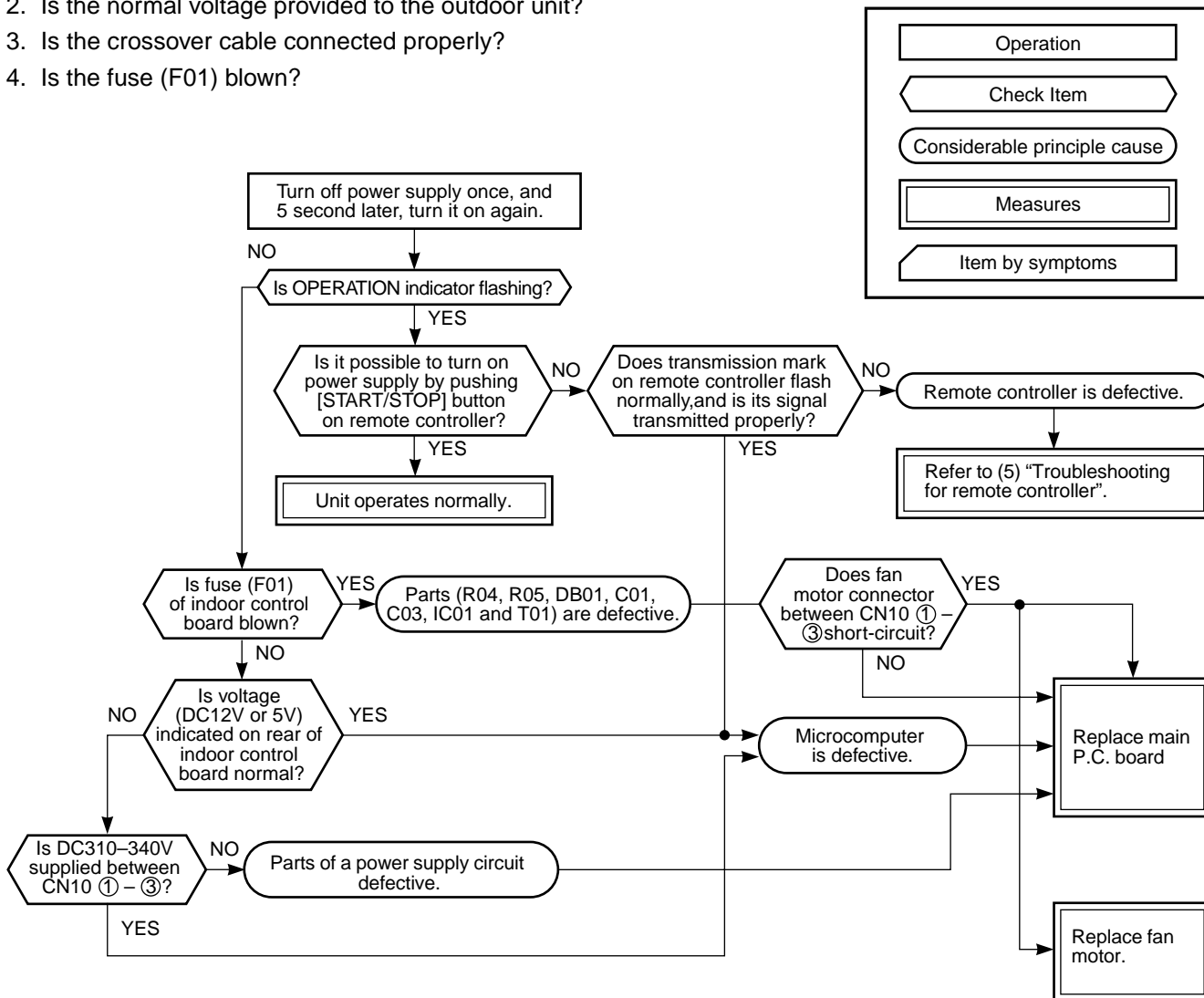

- Be sure to disconnect the motor connector CN10 after shut off the power supply, or it will be a cause of damage of the motor.

(2) Power is not turned on though Indoor P.C. board is replaced

<Confirmation procedure>

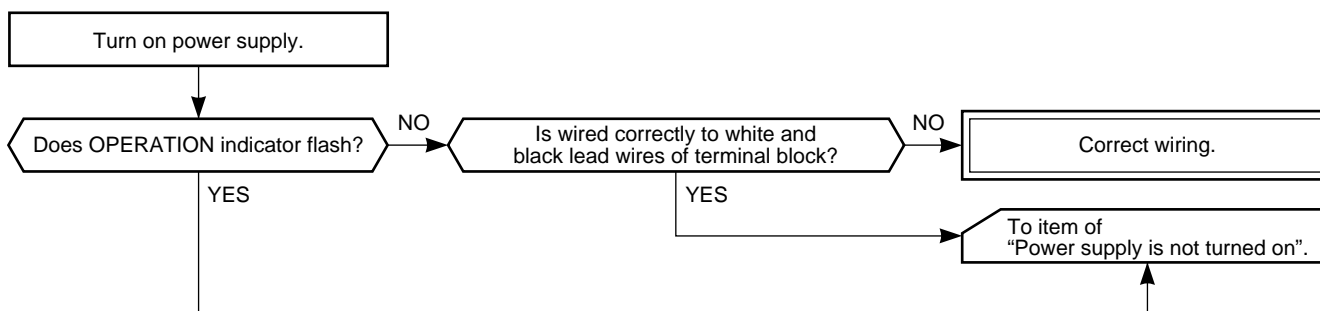

(3) Only the indoor motor fan does not operate

<Primary check>

1. Is it possible to detect the power supply voltage (AC220–240V) between ① and ② on the terminal block?
2. Does the indoor fan motor operate in cooling operation?
(In heating operation, the indoor fan motor does not operate for approximately 10 minutes after it is turned on, to prevent a cold air from blowing in.)

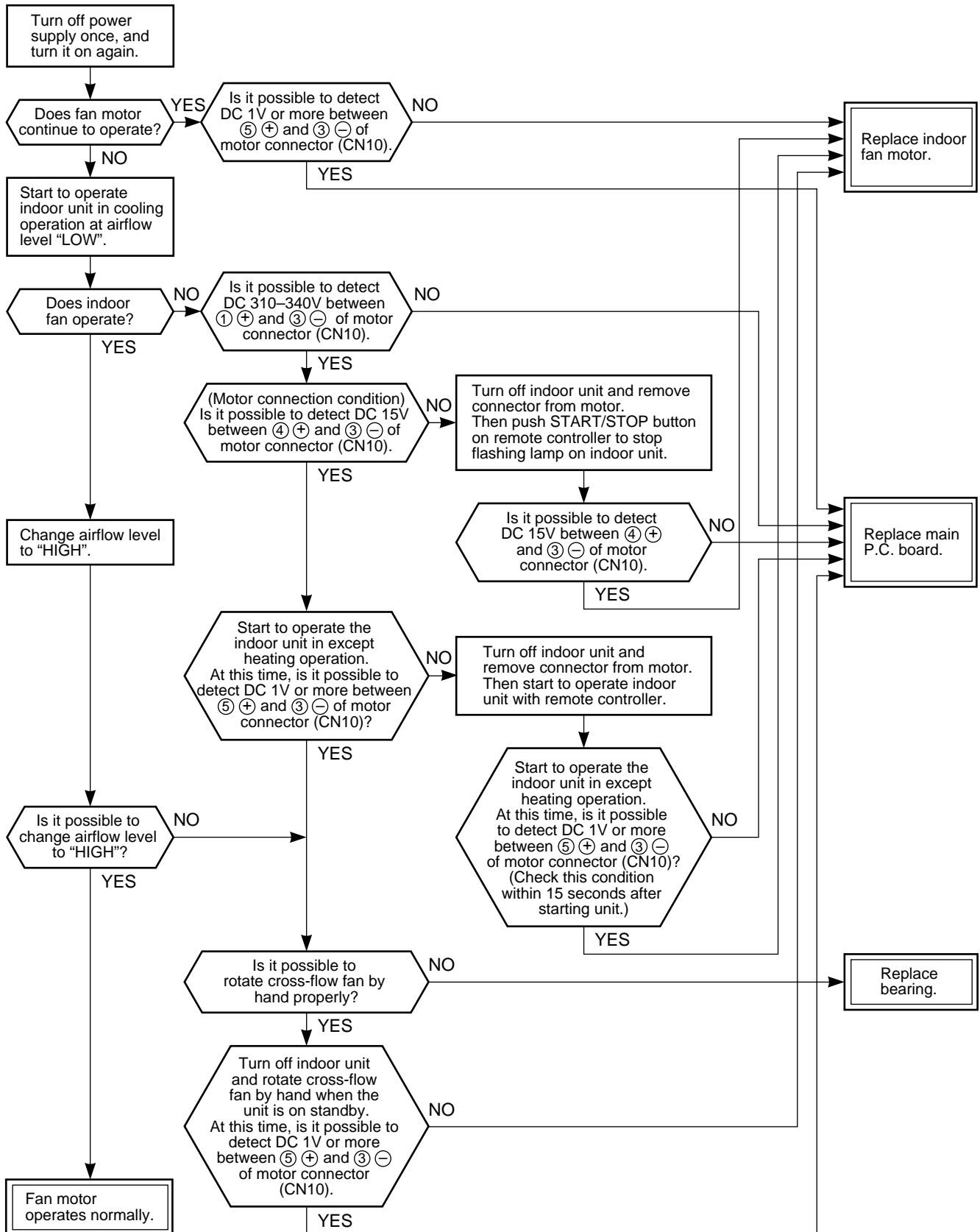

(4) Indoor fan motor automatically starts to rotate by turning on power supply

<Cause>

The IC is built in the indoor fan motor. Therefore the P.C. board is also mounted to inside of the motor.

If the P.C. board is soldered imperfectly or the IC is defective, the fan motor may automatically rotate by turning on power supply.

<Inspection procedure>

1. Remove the front panel. (Remove 2 screws.)
2. Remove the cover of the fan motor lead wires.
3. Check DC voltage with CN10 connector while the fan motor is rotating.

NOTE :

- Do not disconnect the connector while the fan motor is rotating.
- Use a thin test rod.

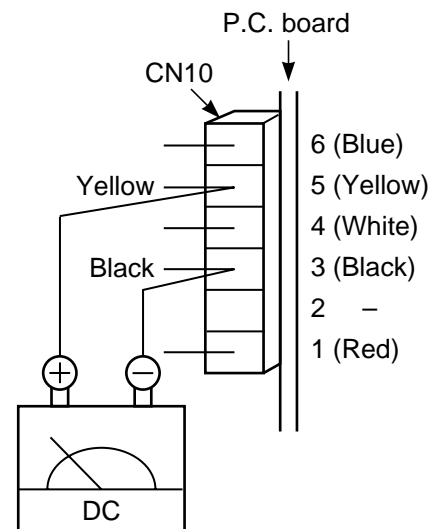
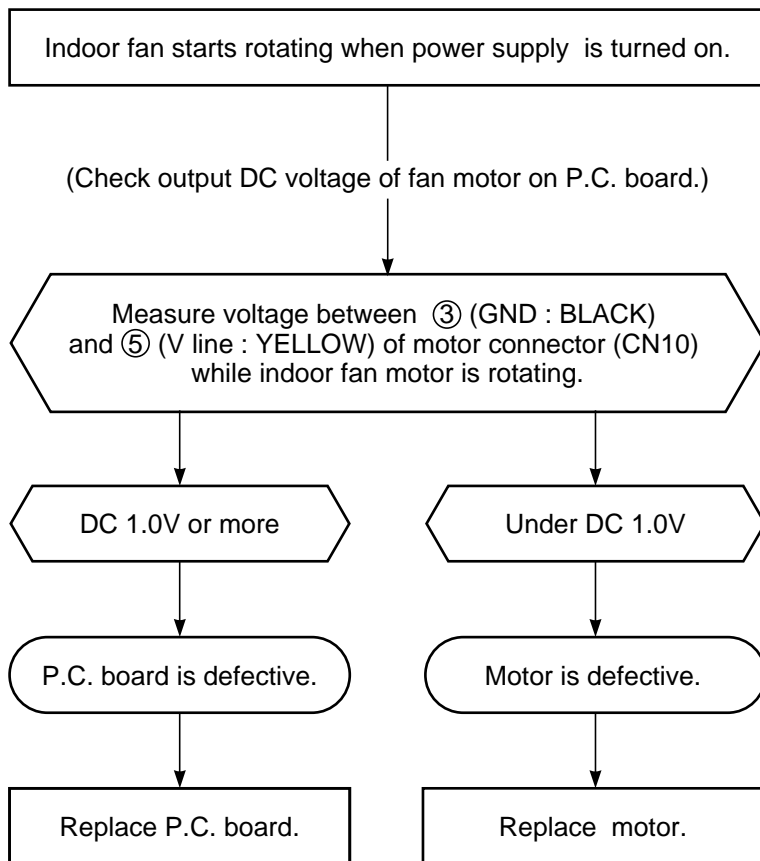

(5) Troubleshooting for remote controller

<Primary check>

Check that A or B selected on the main unit is matched with A or B selected on the remote controller.

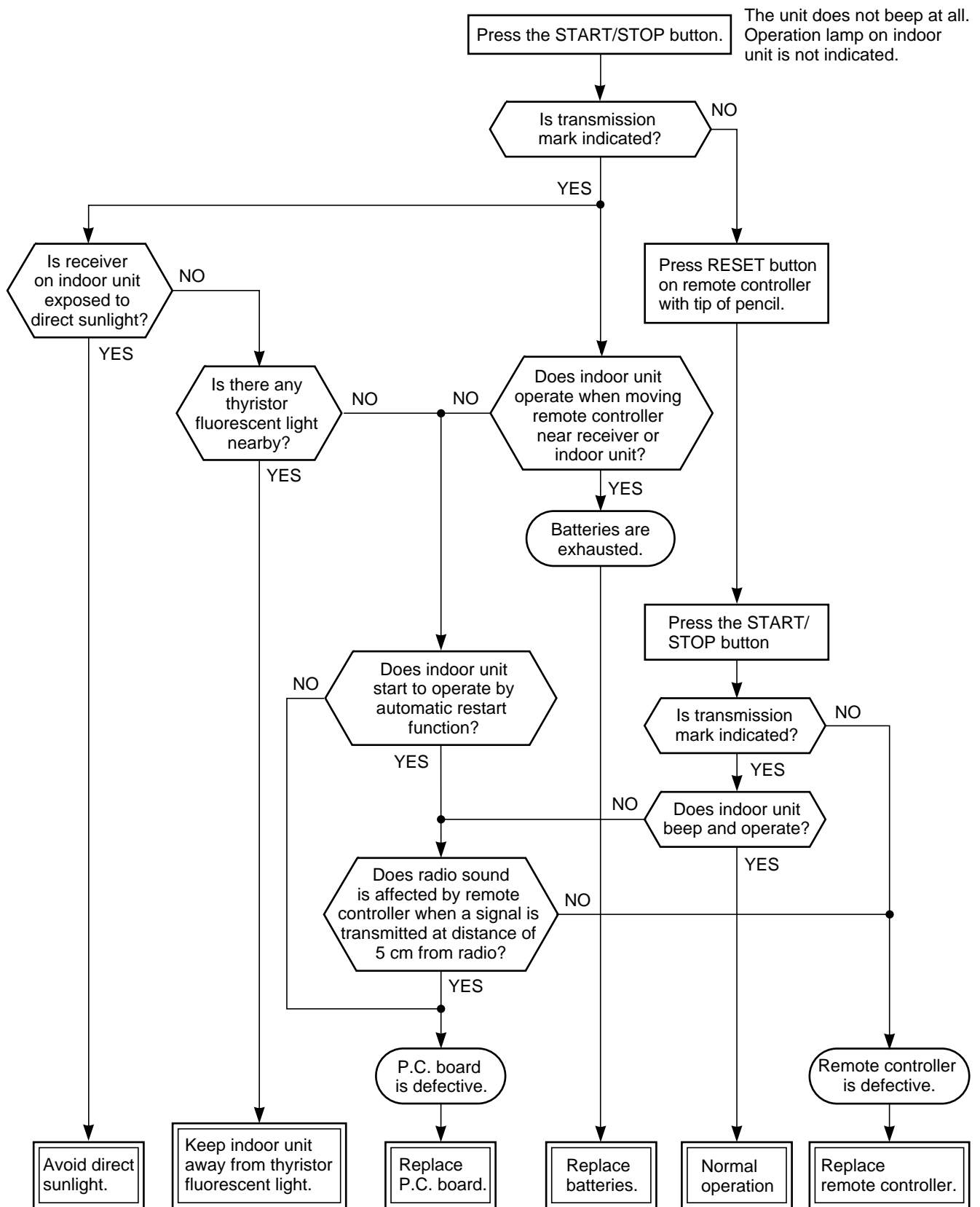

NOTE : After replacing batteries, push the RESET button with a tip of a pencil.

11-4-2. Wiring Failure (Interconnecting and Serial Signal Wire)

(1) Outdoor unit does not operate

- 1) Is the voltage between ② and ③ of the indoor terminal block varied?

Confirm that transmission from indoor unit to outdoor unit is correctly performed based upon the following diagram.

NOTE:

- Measurement should be performed 2 minutes and 30 seconds after starting of the operation.
- Be sure to prepare a diode for judgment.

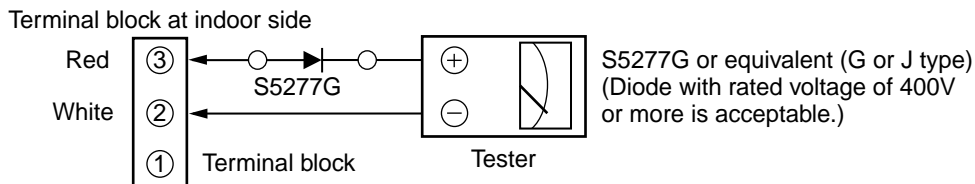

Normal time : Voltage swings between DC15 and 60V. Inverter Assembly check (11-9-1.)

Abnormal time : Voltage does not vary.

(2) Outdoor unit stops in a little while after operation started

<Check procedure> Select phenomena described below.

- 1) The outdoor unit stops 10 to 20 minutes after operation started, and 10 minutes or more are required to restart the unit.

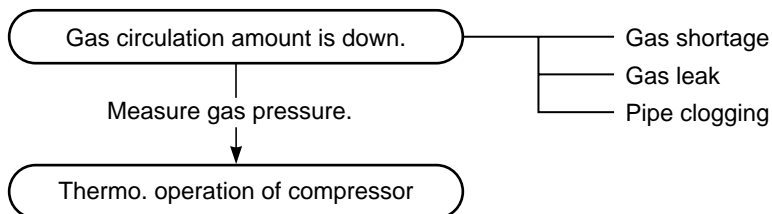

- 2) If the unit stops once, it does not operate until the power will be turned on again.

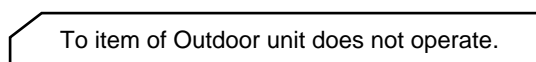

- 3) The outdoor unit stops 10 minutes to 1 hour after operation started, and an alarm is displayed.
(Discharge temp. error check code 03, 1E Sensor temp. error check code 02, 1C)

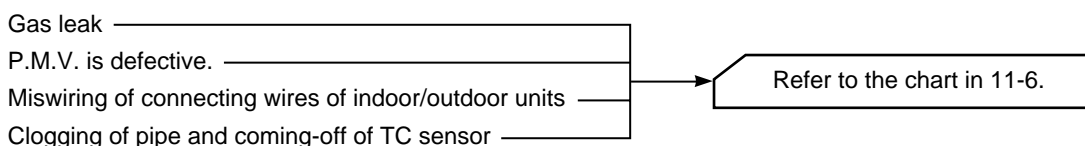

11-5. Trouble Diagnosis by Outdoor LED

For the outdoor unit, the self-diagnosis is possible by LED (Yel) and four LEDs (Red).

- LED (Yel) (D800) and LEDs (Red) (D801 to D804) are provided on the sub-control board under surface of the inverter, and as shown below, they are checked from the wiring port when removing the wiring cover.

- If a trouble occurs, LED (Red or Yel) goes on according to the trouble as described in the table below.
- When two or more troubles occur, LEDs go on cyclically.
- Usually, LEDs (Red or Yel) go off.

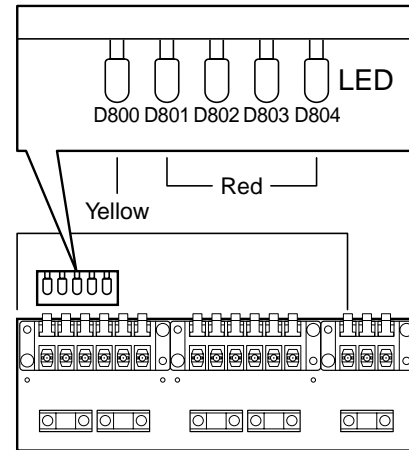

Fig. 11-5-1

○ : LED ON, ● : LED OFF

IGBT : Insulated Gate Bipolar Transistor, P.M.V. : Pulse Motor Valve

LED display					Indoor check code	Description
D800	D801	D802	D803	D804		
●	●	●	●	●	—	During normal operation
●	○	●	●	●	14	IGBT short circuit, compressor motor rare short
○	○	●	●	●	16	Position-detect circuit error
●	●	○	●	●	17	Current-detect circuit error
○	●	○	●	●	1C	Compressor system error
●	○	○	●	●	19	Discharge temp. sensor (TD) error
○	○	○	●	●	1A	Outdoor fan error
●	●	●	○	●	1B	Outside temp. sensor (TO) error
○	●	●	○	●	1D	Compressor lock
●	○	●	○	●	1E	Discharge temp. sensor error, gas leakage
○	○	●	○	●	1F	Compressor break down
*4	●	●	○	○	18	Suction temp. sensor (TS) error
*4	○	●	○	○	18	Evaporator temp. sensor (TE) error
*2	○	○	○	○	1C	A room gas side temp. sensor (TGa) error
*2	○	●	●	●	1C	B room gas side temp. sensor (TGb) error
*2	○	○	●	●	1C	C room gas side temp. sensor (TGc) error
*2, *3	●	●	●	●	1C	D room gas side temp. sensor (TGd) error
*1	●	○	○	●	1C	Gas leakage, P.M.V. sensor error
*1	○	○	○	●	1C	Indoor heat exchanger sensor (TC) disconnection, P.M.V. sensor error
	●	●	●	○	1C	Indoor/outdoor miswiring, gas leakage, TC sensor disconnection, P.M.V. sensor error
	○	○	●	○	1C	Communication error between MCU

*1 : Back-up operation is performed without block display of the indoor unit.

*2 : Operated normally when the air conditioners in other rooms are driven.

*3 : 4 units Multi model only

*4 : Heat pump model only

11-6. Troubleshooting

11-6-1. How to Check Whether the Air Purifier is Good or Not

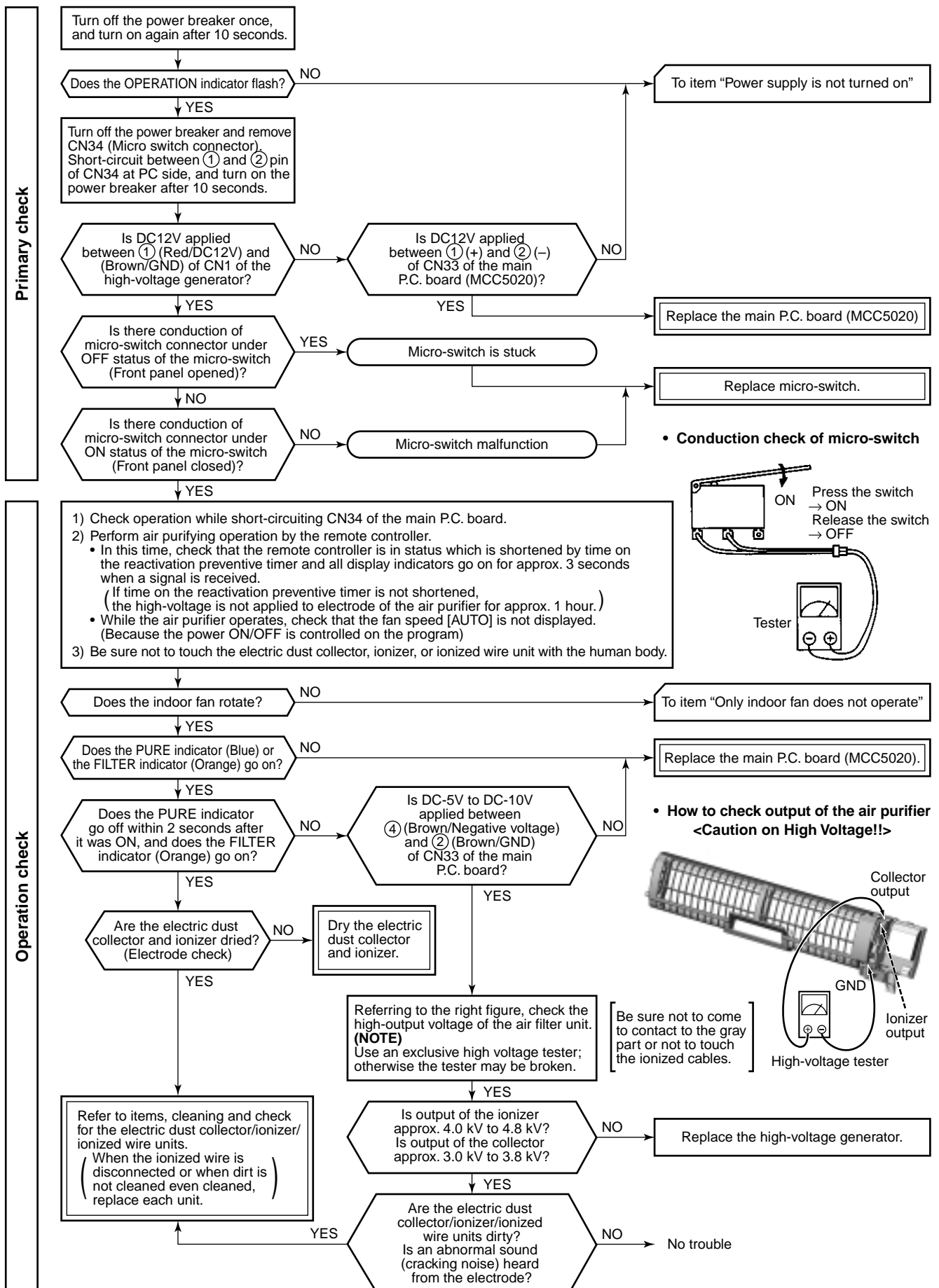

11-6-2. How to Check Whether the Minus Ion Generator is Good or Not

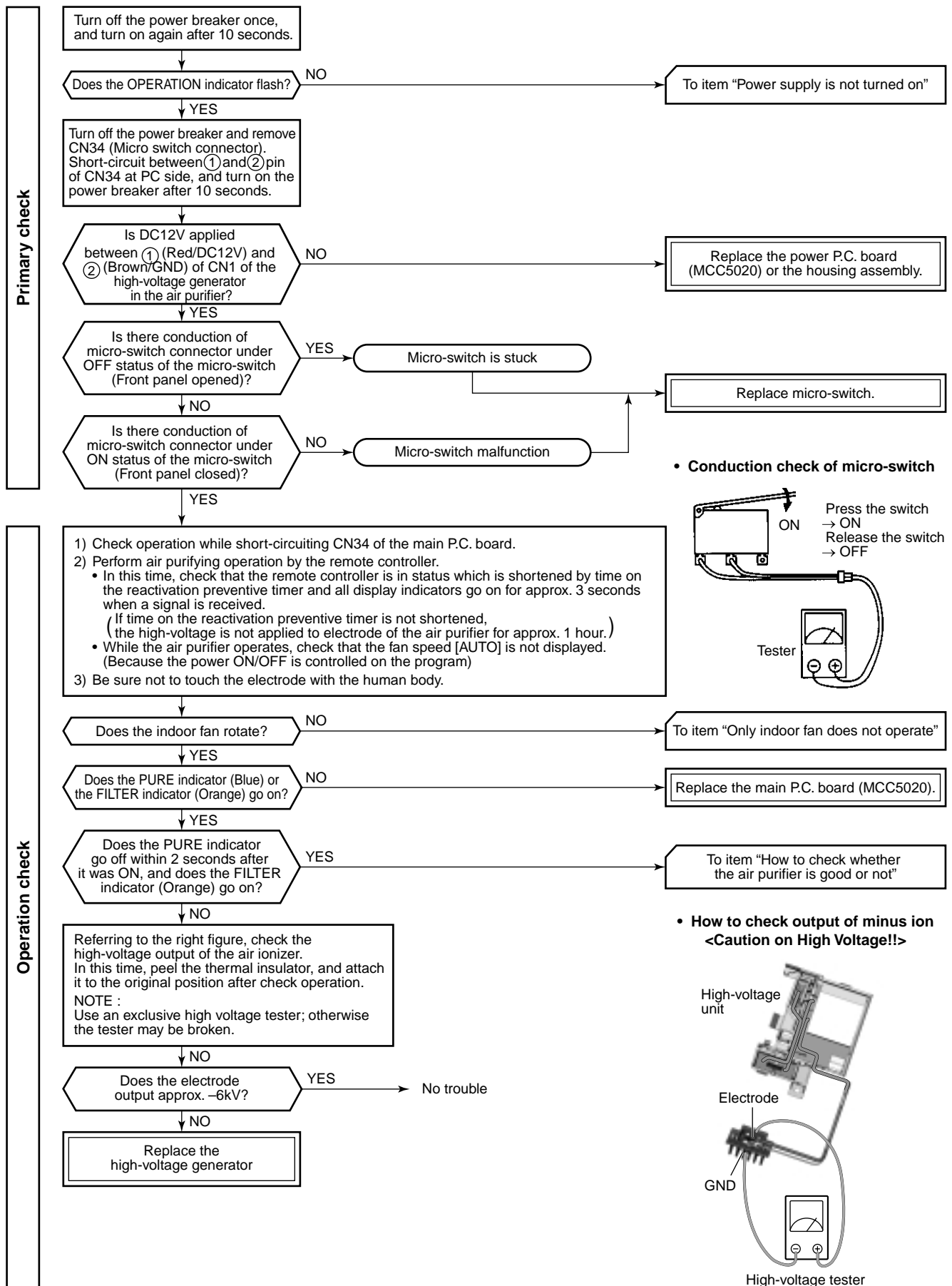

11-7. How to Diagnose Trouble in Outdoor Unit

11-7-1. Summarized Inner Diagnosis of Inverter Assembly

Table 11-7-1

Diagnosis/Process flowchart	Item	Contents	Summary
	<p>Preparation</p> <p>Check</p> <p>Check</p> <p>Operation</p> <p>Measurement</p> <p>Check</p> <p>Stop</p> <p>Check Measurement</p>	<p>Turn "OFF" the power supply breaker, and remove 3P connector which connects inverter and compressor.</p> <ul style="list-style-type: none"> Check whether 25A fuse on the control board assembly is blown or not. (F01) <p>Turn on the power breaker, and operate the air conditioner in COOL mode by time shortening.</p> <p>Measure terminal voltage of the electrolytic capacity.</p> <p style="border: 1px solid black; padding: 2px; display: inline-block;">760μF:400WV × 4</p> <p>After operation, turn off the power breaker after 2 minutes 20 seconds passed, and discharge the electrolytic capacitor by soldering iron.</p> <p>Check voltage between motor phases.</p> <ul style="list-style-type: none"> Is not winding between ①-②, ②-③, or ①-③ opened or short-circuited? Is not frame grounded with ①, ②, or ③? 	<p>If fuse was blown, be sure to check the electrolytic capacitor and diode block.</p> <ul style="list-style-type: none"> Connect discharge resistance (approx. 100Ω, 40W) or soldering iron (plug) between +, - terminals of the electrolytic capacitor (760μF) of C14 (with printed CAUTION HIGH VOLTAGE) on P.C. board. <p>Discharging position (Discharging period 10 seconds or more)</p> <p>OK if 760μF → DC280 to 380V</p> <p>Remove CN300 while pushing the part indicated by an arrow because CN300 is a connector with lock.</p> <p>→ Resistance between phases should be approx. 25 to 55Ω</p> <p>→ Should be 10MΩ or more.</p>

Diagnosis/Process flowchart	Item	Contents	Summary
	<p>Check</p> <p>Operation</p> <p>Check</p>	<p>Check winding resistance between phases of compressor, and resistance between outdoor frames by using a tester.</p> <ul style="list-style-type: none"> • Is not grounded. • Is not short-circuited between windings. • Winding is not opened. <p>Remove connector CN300 of the outdoor fan motor, turn on the power breaker, and perform the operation. (Stops though activation is prompted.)</p> <p>Check operation within 2 minutes 20 seconds after activation stopped.</p> <p><Output check of fan motor position detect signal> While connecting connector 5P (CN301) for position detection, using a tester, measure voltage between ① - ⑤. Between ⑤ - ④ : 5V</p>	<p>→ OK if 10MΩ or more</p> <p>} → OK if 0.2Ω (under 20°C) (Check by a digital tester.)</p> <p>a) One or two of three voltages should be 5V, and others should be 0V. (When all are 0V or 5V, it is not accepted.)</p> <p>b) When rotating the fan slowly with hands, the voltage between pins should move from 0V to 5V. (Check it with an analog tester.)</p>

11-8. How to Check Simply the Main Parts

11-8-1. How to Check the P.C. Board (Indoor Unit)

(1) Operating precautions

- 1) When removing the front panel or the P.C. board, be sure to shut off the power supply breaker.
- 2) When removing the P.C. board, hold the edge of the P.C. board and do not apply force to the parts.
- 3) When connecting or disconnecting the connectors on the P.C. board, hold the whole housing. Do not pull at the lead wire.

(2) Inspection procedures

- 1) When a P.C. board is judged to be defective, check for disconnection, burning, or discoloration of the copper foil pattern or this P.C. board.
- 2) The P.C. board consists of the following 2 parts

a. Main P.C. board part :

DC power supply circuit (5V, 12V, 35V), Indoor fan motor control circuit, CPU and peripheral circuits, buzzer, and Driving circuit of top/ bottom louver.

b. Indication unit of infrared ray receiving infrared ray receiving circuit, LED :

To check defect of the P.C. board, follow the procedure described below.

(3) Check procedures

Table 11-8-1

No.	Procedure	Check points	Causes
1	Turn off the power supply breaker and remove the P.C. board assembly from electronic parts base. Remove the connecting cables from the terminal block.	Check whether or not the fuse (F01) is blown.	Impulse voltage was applied or the indoor fan motor short-circuited.
2	Remove the connector of the motor and turn on the power supply breaker. If OPERATION indicator flashes (once per second), it is not necessary to check steps (1 to 3) in the right next column.	Check power supply voltage : 1. Between No. 1 and No. 3 of CN23 (AC 220–240V) 2. Between ⊕ and ⊖ of C03 (DC 310–340V) 3. Between ⊖ of C10 and output side of IC08 (DC 15V) 4. Between 12V and GND 5. Between 5V and GND	1. The terminal block or the crossover cable is connected wrongly. 2. The capacitor (C01), line filter (L01), resistor (R05), or the diode (DB01) is defective. 3. IC01, IC08 and T01 are defective. 4. IC01, IC08 and T01 are defective. 5. IC01, IC08, IC07 and T01 are defective.
3	Press [START/STOP] button once to start the unit. (Do not set the mode to On-Timer operation.)	Check power supply voltage : 1. Between CN21 and No. 1 of CN23 (DC 15–60V)	IC03 and IC04 are defective.
4	Shorten the restart delay timer and start unit.	Check whether or not all indicators (OPERATION, TIMER, FILTER, PURE) are lit for 3 seconds and they return to normal 3 seconds later.	The indicators are defective or the housing assembly (CN13) is defective.
5	Press [START/STOP] button once to start the unit, • Shorten the restart delay timer. • Set the operation mode to COOL. • Set the fan speed level to AUTO. • Set the preset temperature much lower than the room temperature. (The unit (compressor) operates continuously in the above condition.)	1. Check whether or not the compressor operates. 2. Check whether or not the OPERATION indicator flashes.	1. The temperature of the indoor heat exchanger is extremely low. 2. The connection of the heat exchanger sensor is loose. (The connector is disconnected.) (CN01) 3. The heat exchanger sensor and the P.C. board are defective. (Refer to Table 11-3-1.) 4. The main P.C. board is defective.
6	If the above condition (No. 5) still continues, start the unit in the following condition. • Set the operation mode to HEAT. • Set the preset temperature much higher than room temperature.	1. Check whether or not the compressor operates. 2. Check whether or not the OPERATION indicator flashes.	1. The temperature of the indoor heat exchanger is extremely high. 2. The connection of the heat exchanger sensor short-circuited. (CN01) 3. The heat exchanger sensor and the P.C. board are defective. (Refer to Table 11-3-1.) 4. The main P.C. board is defective
7	Connect the motor connector to the motor and turn on the power supply. Start the unit the following condition. • Set the fan speed level to HIGH. (The unit (compressor) operates continuously in the above condition in No. 5.)	1. Check it is impossible to detect the voltage (DC 15V) between 3 and 4 of the motor terminals. 2. The motor does not operate or the fan motor does not rotate with high speed. (But it is possible to receive the signal from the remote controller.) 3. The motor rotates but vibrates strongly.	1. The indoor fan motor is defective. (Protected operation of P.C. board.) 2. The P.C. board is defective. 3. The connection of the motor connector is loose.

11-8-2. P.C. Board Layout

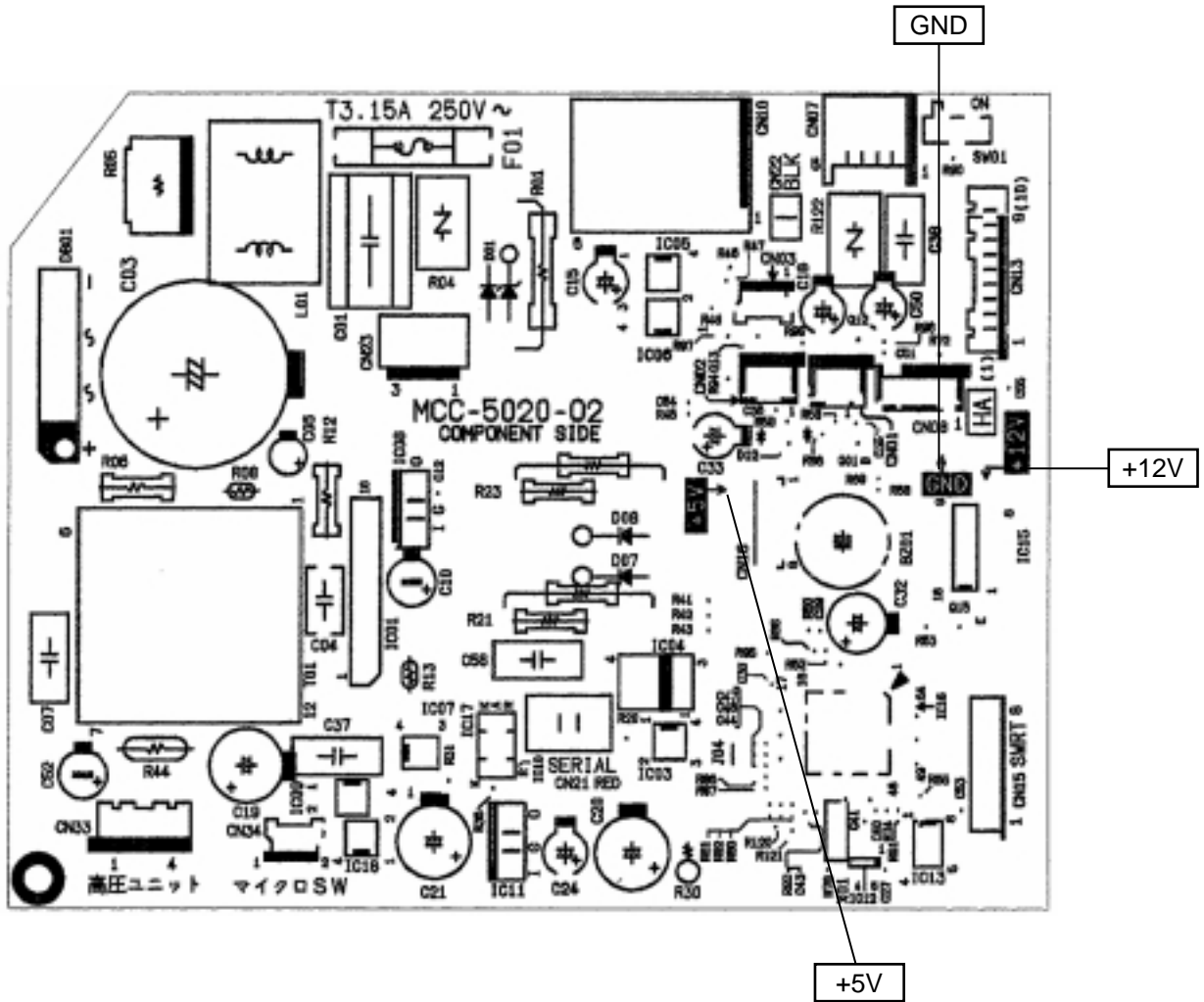

[1] Sensor characteristic table

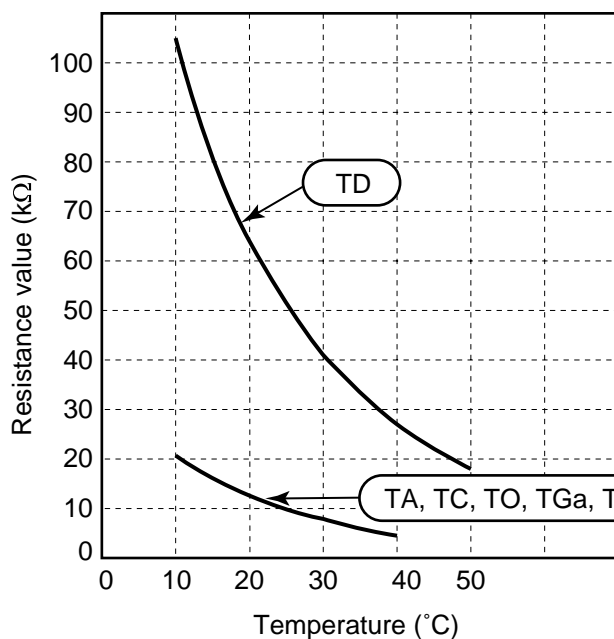

- TD : Discharge temp. sensor
- TA : Room temp. sensor
- TC : Heat exchanger temp. sensor
- TO : Outdoor temp. sensor
- TE : Outdoor heat exchanger temp. sensor
- TS : Suction temp. sensor
- TGa : A room Gas side temp. sensor
- TGb : B room Gas side temp. sensor
- TGc : C room Gas side temp. sensor
- TGd : D room Gas side temp. sensor

11-8-3. Indoor Unit (Other Parts)

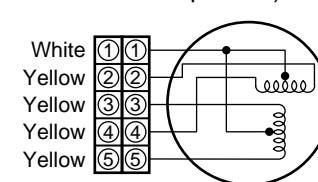
No.	Part name	Checking procedure												
1	Room temp. (TA) sensor Heat exchanger (TC) sensor	<p>Disconnect the connector and measure the resistance value with tester. (Normal temp.)</p> <table border="1"> <thead> <tr> <th>Sensor \ Temperature</th> <th>10°C</th> <th>20°C</th> <th>25°C</th> <th>30°C</th> <th>40°C</th> </tr> </thead> <tbody> <tr> <td>TA, TC (kΩ)</td> <td>20.7</td> <td>12.6</td> <td>10.0</td> <td>7.9</td> <td>4.5</td> </tr> </tbody> </table>	Sensor \ Temperature	10°C	20°C	25°C	30°C	40°C	TA, TC (kΩ)	20.7	12.6	10.0	7.9	4.5
Sensor \ Temperature	10°C	20°C	25°C	30°C	40°C									
TA, TC (kΩ)	20.7	12.6	10.0	7.9	4.5									
2	Remote controller	Refer to 11-4-1. (5).												
3	Louver motor MP24Z	<p>Measure the resistance value of each winding coil by using the tester. (Under normal temp. 25°C)</p>  <table border="1"> <thead> <tr> <th>Position</th> <th>Resistance value</th> </tr> </thead> <tbody> <tr> <td>1 to 2</td> <td rowspan="5">380 ± 40Ω</td> </tr> <tr> <td>1 to 3</td> </tr> <tr> <td>1 to 4</td> </tr> <tr> <td>1 to 5</td> </tr> <tr> <td>1 to 5</td> </tr> </tbody> </table>	Position	Resistance value	1 to 2	380 ± 40Ω	1 to 3	1 to 4	1 to 5	1 to 5				
Position	Resistance value													
1 to 2	380 ± 40Ω													
1 to 3														
1 to 4														
1 to 5														
1 to 5														
4	Indoor fan motor	Refer to 11-4-1. (3) and (4).												

11-8-4. Outdoor Unit

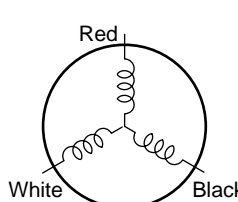
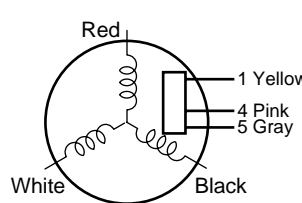
No.	Part name	Checking procedure																								
1	Compressor (Model : DA220A2F-20L1)	<p>Measure the resistance value of each winding by using the tester.</p>  <table border="1"> <thead> <tr> <th>Position</th> <th>Resistance value</th> </tr> </thead> <tbody> <tr> <td>Red - White</td> <td rowspan="3">0.2 ± 0.01Ω</td> </tr> <tr> <td>White - Black</td> </tr> <tr> <td>Black - Red</td> </tr> </tbody> </table> <p style="text-align: right;">Under 20°C</p>	Position	Resistance value	Red - White	0.2 ± 0.01Ω	White - Black	Black - Red																		
Position	Resistance value																									
Red - White	0.2 ± 0.01Ω																									
White - Black																										
Black - Red																										
2	Outdoor fan motor (Model : ICF-140-63-2R)	<p>Measure the resistance value of winding by using the tester.</p>  <table border="1"> <thead> <tr> <th>Position</th> <th>Resistance value</th> </tr> </thead> <tbody> <tr> <td>Yellow - Pink</td> <td>5 to 20 kΩ</td> </tr> </tbody> </table> <p style="text-align: right;">For details, refer to Section 11-5.</p>	Position	Resistance value	Yellow - Pink	5 to 20 kΩ																				
Position	Resistance value																									
Yellow - Pink	5 to 20 kΩ																									
3	Compressor thermo. Bimetal type (Model : US622KXTMQO)	Check conduction by using the tester.																								
4	Outdoor temperature sensor (TO), pipe temperature sensor (TGa, TGb, TGc, TGd), discharge temperature sensor (TD), suction temperature sensor (TS), evaporator temperature sensor (TE),	<p>Disconnect the connector, and measure resistance value with the tester. (Normal temperature)</p> <table border="1"> <thead> <tr> <th>Sensor \ Temperature</th> <th>10°C</th> <th>20°C</th> <th>25°C</th> <th>40°C</th> <th>50°C</th> </tr> </thead> <tbody> <tr> <td>TA, TC (kΩ)</td> <td>105</td> <td>64</td> <td>51</td> <td>27</td> <td>18</td> </tr> <tr> <td>TO, TE, TS (kΩ)</td> <td>20.6</td> <td>12.6</td> <td>10.0</td> <td>5.1</td> <td>3.4</td> </tr> <tr> <td>TGa, TGb, TGc, TGd (kΩ)</td> <td>20.0</td> <td>12.5</td> <td>10.0</td> <td>5.3</td> <td>3.6</td> </tr> </tbody> </table>	Sensor \ Temperature	10°C	20°C	25°C	40°C	50°C	TA, TC (kΩ)	105	64	51	27	18	TO, TE, TS (kΩ)	20.6	12.6	10.0	5.1	3.4	TGa, TGb, TGc, TGd (kΩ)	20.0	12.5	10.0	5.3	3.6
Sensor \ Temperature	10°C	20°C	25°C	40°C	50°C																					
TA, TC (kΩ)	105	64	51	27	18																					
TO, TE, TS (kΩ)	20.6	12.6	10.0	5.1	3.4																					
TGa, TGb, TGc, TGd (kΩ)	20.0	12.5	10.0	5.3	3.6																					

11-8-5. Checking Method for Each Part

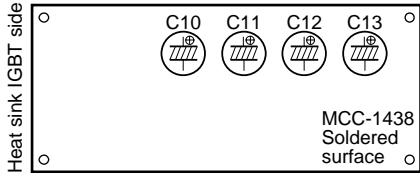
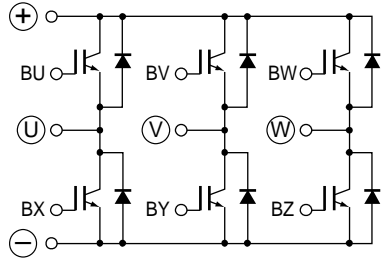
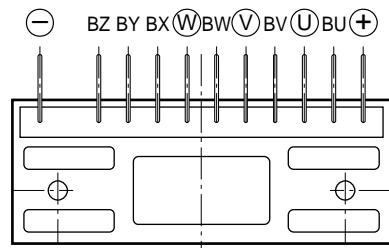
No.	Part name	Checking procedure																													
1	Electrolytic capacitor (For raising pressure, smoothing)	<p>1. Turn OFF the power supply breaker. 2. Discharge all three capacitors completely. 3. Check that safety valve at the bottom of capacitor is not broken. 4. Check that vessel is not swollen or exploded. 5. Check that electrolytic liquid does not blow off. 6. Check that the normal charging characteristics are shown in continuity test by the tester.</p> <div style="display: flex; justify-content: space-around; align-items: center;"> <div style="border: 1px solid black; padding: 5px;"> <p style="font-size: small;">Heat sink IGBT side</p>  </div> <div style="border: 1px solid black; padding: 5px; width: 200px;"> <p style="text-align: center;">Case that product is good</p> <p style="font-size: x-small;">Pointer swings once, and returns slowly. When performing test once again under another polarity, the pointer should return.</p> </div> </div> <p style="text-align: center; margin-top: 10px;">C12, C13, C14, C15 → 500μF/400V</p>																													
2	IGBT module	<p>1. Turn OFF the power supply switch. 2. Discharge all four electrolytic capacitors completely. 3. Execute continuity test with a tester.</p> <div style="display: flex; justify-content: space-around; align-items: center;"> <div style="text-align: center;">  </div> <div style="text-align: center;">  </div> </div> <table border="1" style="width: 100%; text-align: center; border-collapse: collapse; margin-top: 10px;"> <tr> <td rowspan="2" style="width: 15%;">Tester rod</td> <td style="width: 10%;">+</td> <td style="width: 10%;">+</td> <td style="width: 10%;">U</td> <td style="width: 10%;">V</td> <td style="width: 10%;">W</td> <td style="width: 10%;">-</td> <td style="width: 10%;">U</td> <td style="width: 10%;">V</td> <td style="width: 10%;">W</td> </tr> <tr> <td>-</td> <td>U</td> <td>V</td> <td>W</td> <td>-</td> <td>W</td> <td>U</td> <td>V</td> <td>+</td> </tr> <tr> <td>Case that product is good</td> <td colspan="2">1MΩ or more</td> <td colspan="3">100kΩ to 300kΩ</td> <td colspan="4">200kΩ to 300kΩ</td> </tr> </table>	Tester rod	+	+	U	V	W	-	U	V	W	-	U	V	W	-	W	U	V	+	Case that product is good	1MΩ or more		100kΩ to 300kΩ			200kΩ to 300kΩ			
Tester rod	+	+		U	V	W	-	U	V	W																					
	-	U	V	W	-	W	U	V	+																						
Case that product is good	1MΩ or more		100kΩ to 300kΩ			200kΩ to 300kΩ																									

11-9. How to Simply Judge Whether Outdoor Fan Motor is Good or Bad

1. Symptom

- Outdoor fan motor does not rotate.
 - Outdoor fan motor stops within several tens seconds though it started rotating.
 - Outdoor fan motor rotates or does not rotate according to the position where the fan stopped, etc.
- Remote controller check code "02 : Outdoor block, 1A : Outdoor fan drive system error"

2. Cause

The following causes are considered when the outdoor fan motor does not normally rotate.

- 1) Mechanical lock of the outdoor fan motor
 - 2) Winding error of the outdoor fan motor
 - 3) Position-detect circuit error inside of the outdoor fan motor
- or
- 4) Motor drive circuit error of the outdoor P.C. board

3. How to simply judge whether outdoor fan motor is good or bad

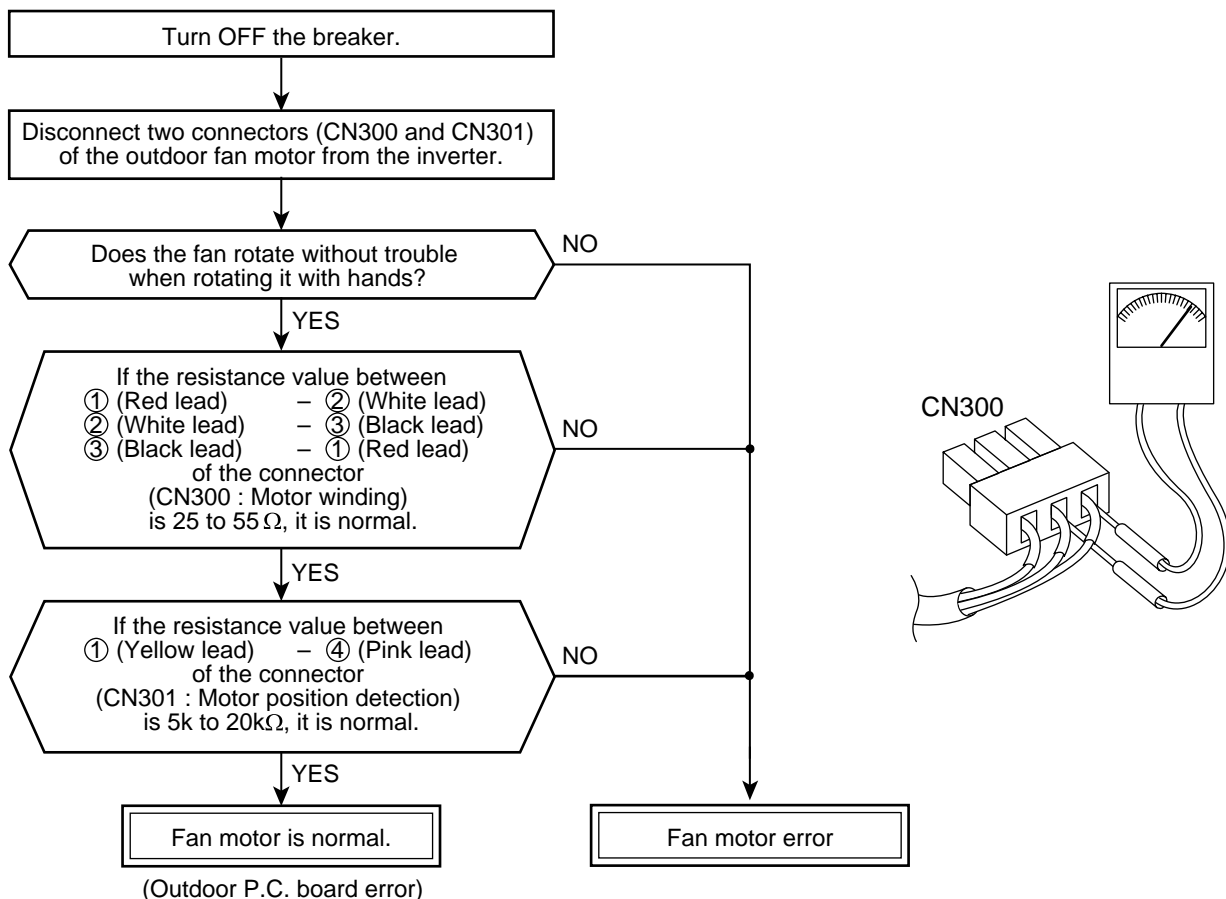

NOTE :

However, GND circuit error inside of the motor may be accepted in some cases when the above check is performed.



When the fan motor does not become normal even if P.C. board is replaced, replace the outdoor fan motor.



12. HOW TO REPLACE THE MAIN PARTS



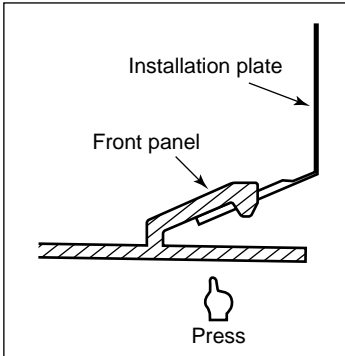
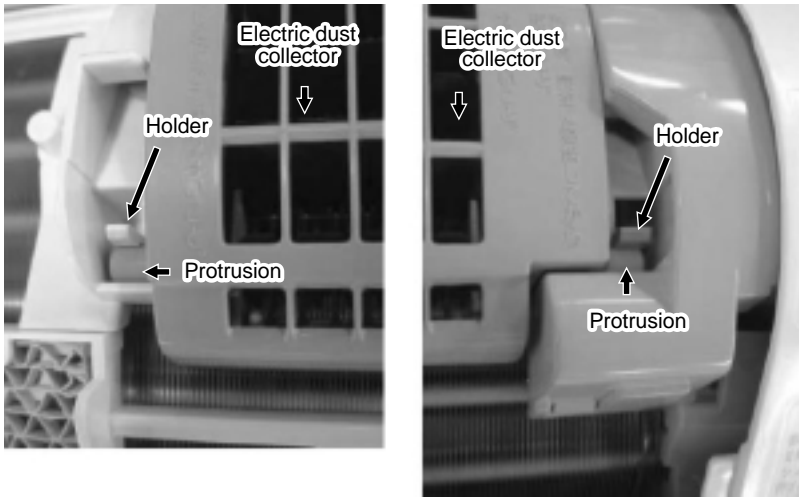
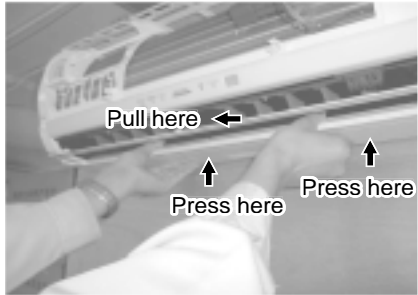

WARNING

- Since high voltages pass through the electrical parts, turn off the power without fail before proceeding with the repairs.
Electric shocks may occur if the power plug is not disconnected.
- After the repairs have been completed (after the front panel and cabinet have been installed), perform a test operation, and check for smoking, unusual sounds and other abnormalities.
If this check is omitted, a fire and/or electric shocks may occur.
Before proceeding with the test operation, install the front panel and cabinet.
- Ensure that the following steps are taken when doing repairs on the refrigerating cycle.
 1. Do not allow any naked flames in the surrounding area.
If a gas stove or other appliance is being used, extinguish the flames before proceeding.
If the flames are not extinguished, they may ignite any oil mixed with the refrigerant gas.
 2. Do not use welding equipment in an airtight room.
Carbon monoxide poisoning may result if the room is not properly ventilated.
 3. Do not bring welding equipment near flammable objects.
Flames from the equipment may cause the flammable objects to catch fire.
- **If keeping the power on is absolutely unavoidable while doing a job such as inspecting the circuitry, wear rubber gloves to avoid contact with the live parts.**
Electric shocks may be received if the live parts are touched.
High-voltage circuits are contained inside this unit.
Proceed very carefully when conducting checks since directly touching the parts on the control circuit board may result in electric shocks.

12-1. Indoor Unit

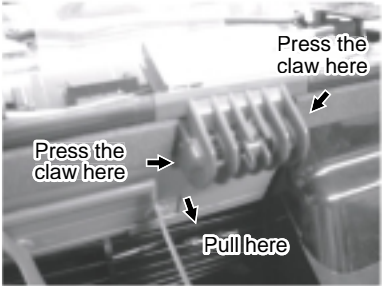

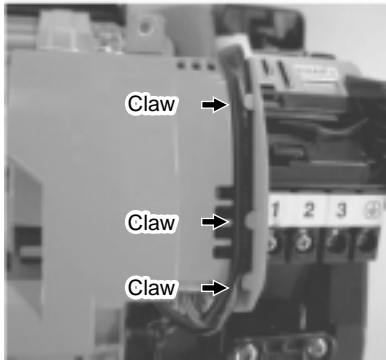
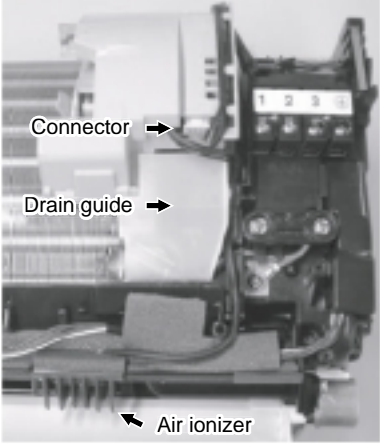
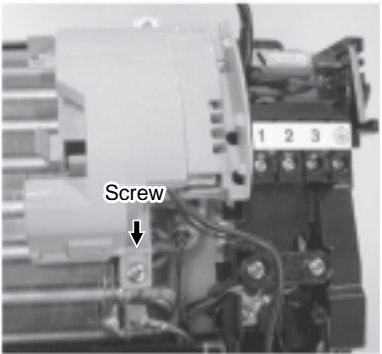
No.	Part name	Procedures	Remarks
①	Front panel	1) Stop operation of the air conditioner and turn off its main power supply. 2) Open the air inlet grille, push the arm toward the outside, and remove the grille. 3) Remove the left and right air filters, and remove the electric dust collector.	 

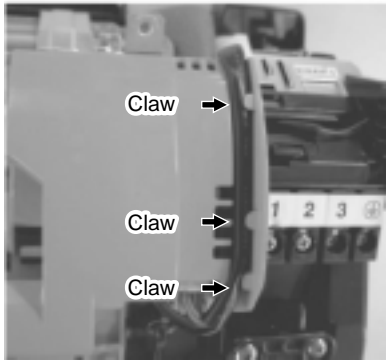
No.	Part name	Procedures	Remarks
①	Front panel	<p>4) Press “ 押す ” part under the front panel and remove hooks of the front panel from the installation plate.</p>  <p>5) Remove the front panel fixing screws. (2 pcs.)</p> <p>6) Press the electric parts box with the right thumb while pulling the both sides of the front panel toward you.</p> <p><How to assemble the front panel></p>  <p>1) Press three center positions and two lower center positions of the air outlet, and then hang the hanging hooks (4 pcs.) at the top side of the front panel to the rear plate.</p> <p>2) Insert the electric dust collector and left and right air filters. Press in the electric dust collector until the protrusions on both sides are completely inserted into the holders. If installation is incomplete, the FILTER indicator (orange) may light.</p> <p>3) Tighten two screws.</p> <ul style="list-style-type: none"> • Incomplete hanging or incomplete pressing may cause a dewdrops or generation of a fluttering sound. 	 

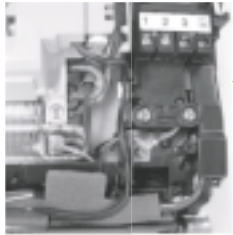
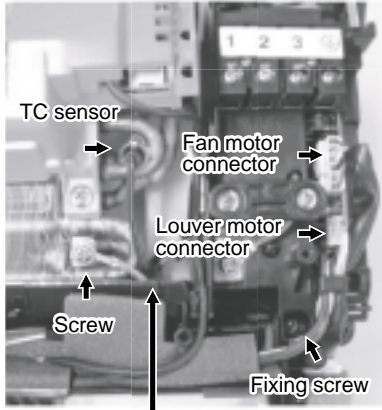
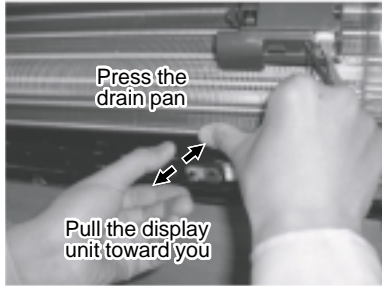
No.	Part name	Procedures	Remarks
②	High voltage generator	<p>1) Follow to the procedure in the item ①.</p> <p>2) Remove the drain guide.</p> <p>3) To remove the air ionizer from the back body, pull it toward you while pressing down on its left and right claws.</p> <p>Disconnect the two leads (black) connected to the air ionizer from where they are fitted into the other components. (Caution: do not remove the Faston.)</p> <p>4) Disconnect the connectors of the high-voltage generator, and disconnect the four leads from where they are fitted into the other components.</p> <p>5) Remove the fixing screw which secures the high voltage generator, and remove the high voltage generator from the evaporator.</p>  <p><How to assemble the high voltage generator></p> <p>1) Insert the high voltage generator straight into the evaporator, and secure it using the fixing screw.</p>  <p>2) Pass the leads of the high voltage generator through the area designated and insert them into its connectors.</p>  <p>3) Attach the air ionizer to the back body, and pass the two leads (black) through the area designated on the electric parts box assembly.</p>  <p>4) Attach the drain guide.</p>	   

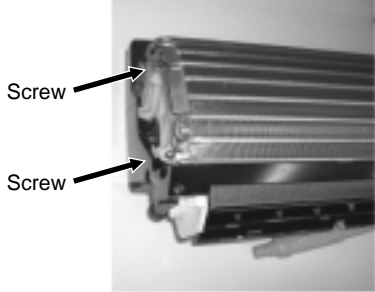
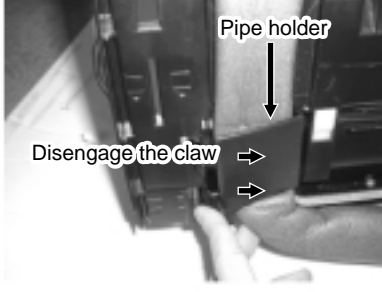
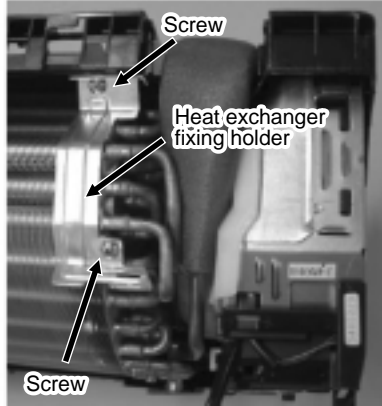
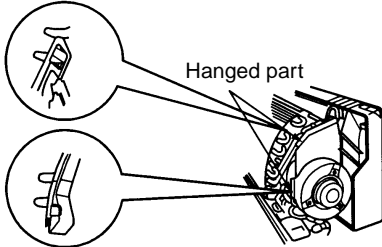
No.	Part name	Procedures	Remarks
③	Electric parts box assembly	<p>1) Follow the procedure up to 4) in ② above.</p> <p>2) Remove screw of earth lead attached to the end plate of the evaporator.</p> <p>3) Remove the lead wire cover, and remove connector (5P) for the fan motor and connector (5P) for the louver motor from the electric parts box assembly.</p> <p>4) Pull out TC sensor from sensor holder of the evaporator.</p> <p>5) Disengage the two claws at the top of the display unit. (They can be easily disengaged by pressing the drain pan above the claws and at the same time pulling the display unit toward you.)</p> <p>6) Remove the fixing screw that secures the electric parts box assembly, and remove the assembly.</p> <p><How to assemble the electric parts box></p> <p>1) Hook the top part of the electric parts box assembly onto the claws on the back body, and secure it using the fixing screw. Now attach the display unit. Connect the connectors for the fan motor and louver motor.</p> <p>2) Secure the grounding wire using the fixing screw. Insert the TC sensor into the sensor holder.</p> <p>* Be absolutely sure to loop the grounding wire and TC sensor leads once at the bottom.</p>	 <p>Lead wire cover</p>  <p>TC sensor</p> <p>Fan motor connector</p> <p>Louver motor connector</p> <p>Screw</p> <p>Fixing screw</p> <p>Make absolutely sure that the leads form a loop</p>  <p>Press the drain pan</p> <p>Pull the display unit toward you</p>

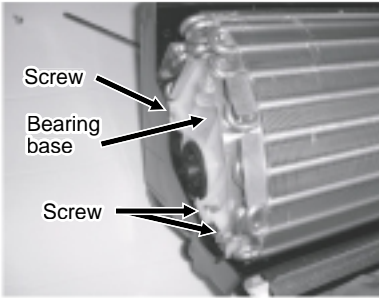
No.	Part name	Procedures	Remarks
④	Horizontal louver	1) Remove shaft of the horizontal louver from the back body. (First remove the left shaft, and then remove other shafts while sliding the horizontal louver leftward.)	
⑤	Evaporator (Heat exchanger)	1) Follow to the procedure in the item ③. 2) Remove the pipe holder from the rear side of the main unit. 3) Remove two fixing screws at the left side of the end plate of the heat exchanger.  4) Remove the heat exchanger fixing holder by removing the two fixing screws used to secure it.  5) Remove right side of the end plate from two fixing ribs while sliding slightly the heat exchanger rightward.  	

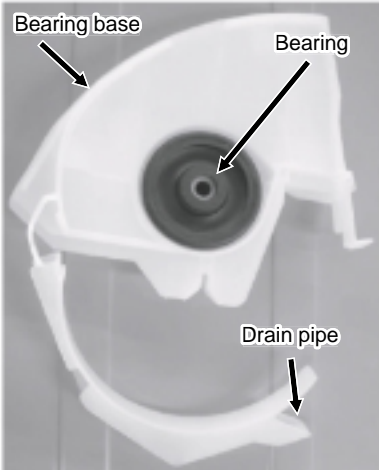
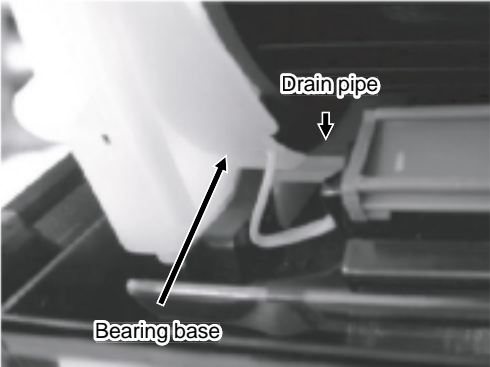
No.	Part name	Procedures	Remarks
⑥	Bearing	<p>1) Follow to the procedure in the items ①.</p> <p>2) Remove the two fixing screws used to secure the left edge panel of the heat exchanger, and remove the two screws used to secure the bearing base.</p> <p>3) Raise the left side of the heat exchanger slightly, and remove the bearing base.</p> <p><Caution at assembling></p> <ul style="list-style-type: none"> • If the bearing is out from the housing, push it into the specified position and then incorporate it in the main body. • After assembling the bearing base, check that it is fitted into the stepped part of the drain pipe. 	 <p>Screw Bearing base Screw</p>  <p>Raise the left side Remove in this direction</p>  <p>Bearing base Bearing Drain pipe</p>  <p>Drain pipe Bearing base</p>

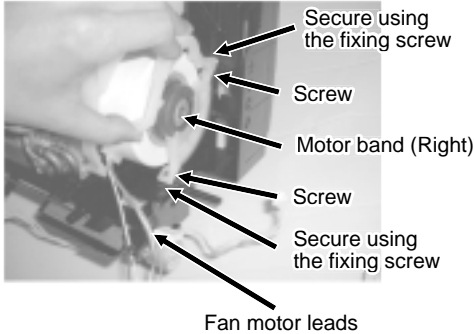
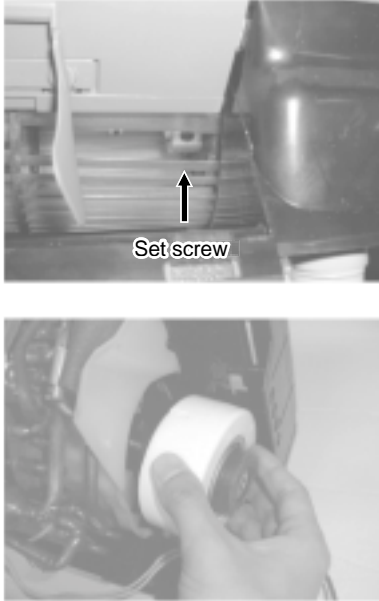
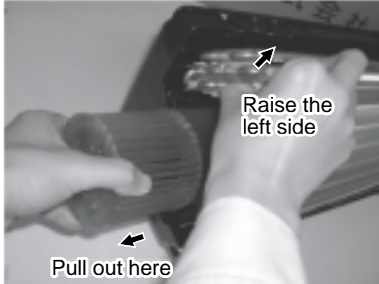
No.	Part name	Procedures	Remarks
⑦	Fan motor	<p>1) Follow to the procedure in the item ③.</p> <p>2) Loosen the set screw of the cross flow fan.</p> <p>3) Remove two fixing screws of the motor band (Right), and then remove the motor band (Right).</p> <p>4) Pull the fan motor outward.</p> <p>In assembling work, install the fan motor as follows.</p> <ul style="list-style-type: none"> • When assembling the fan motor, the fan motor must be installed in such a way that the fan motor leads will be taken out is positioned at the bottom front. • After assembling the two hooking claws of the motor band (right) into the main body, position the fan motor, insert it, and then secure the motor band (right) using the two fixing screws. 	
⑧	Cross flow fan	<p>1) Follow to the procedure in the item ⑥.</p> <p>2) Remove the heat exchanger fixing holder by removing the two fixing screws used to secure it.</p> <p>3) Loosen the set screw of the cross flow fan.</p> <p>4) Lift the left side of the heat exchanger, and pull out the cross flow fan.</p>	

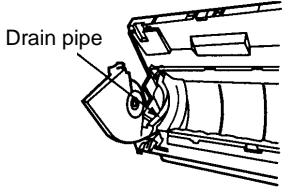
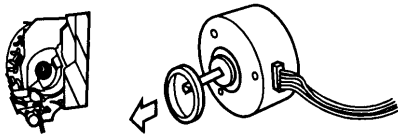
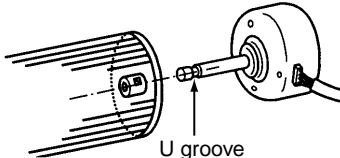
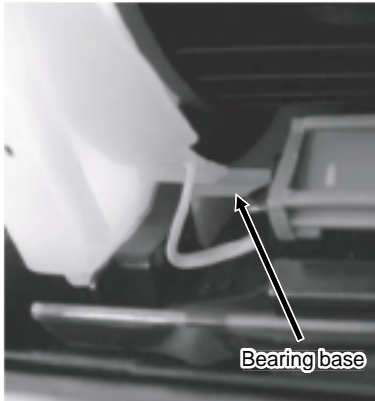
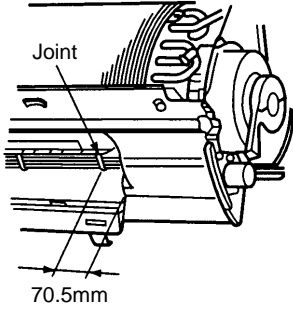
No.	Part name	Procedures	Remarks
⑧	Cross flow fan	<p><Caution at reassembling></p> <p>1) At assembling work of the bearing base, check that the drain pipe is surely incorporated in the back body. (Otherwise, water leak is caused.)</p> <p>2) To incorporate the fan motor, remove the fan motor rubber (at shaft core side), incorporate the motor into the position in the following figure, and then install the fan motor.</p>  <p>Drain pipe</p> <ul style="list-style-type: none"> • Install the cross flow fan so that the right end of the 1st joint from the right of the cross flow fan is set keeping 70.5 mm from wall of rear plate of the main unit. • Holding the set screw, install the cross flow fan so that U-groove of the fan motor comes to the mounting hole of the set screw.  <ul style="list-style-type: none"> • Perform positioning of the fan motor as follows: • When assembling the fan motor, the fan motor must be installed in such a way that the fan motor leads will be taken out is positioned at the bottom front. • After assembling the two hooking claws of the motor band (right) into the main body, position the fan motor, insert it, and then secure the motor band (right) using the two fixing screws.  <p>U groove</p>	 <p>Bearing base</p>  <p>Joint</p> <p>70.5mm</p>

12-2. Microcomputer

No.	Part name	Procedure	Remarks
①	Common procedure	1) Turn the power supply off to stop the operation of air-conditioner. 2) Remove the front panel. • Remove the 2 fixing screws. 3) Remove the electrical part base.	Replace terminal block, microcomputer ass'y and the P.C. board ass'y.

<P.C. board layout>

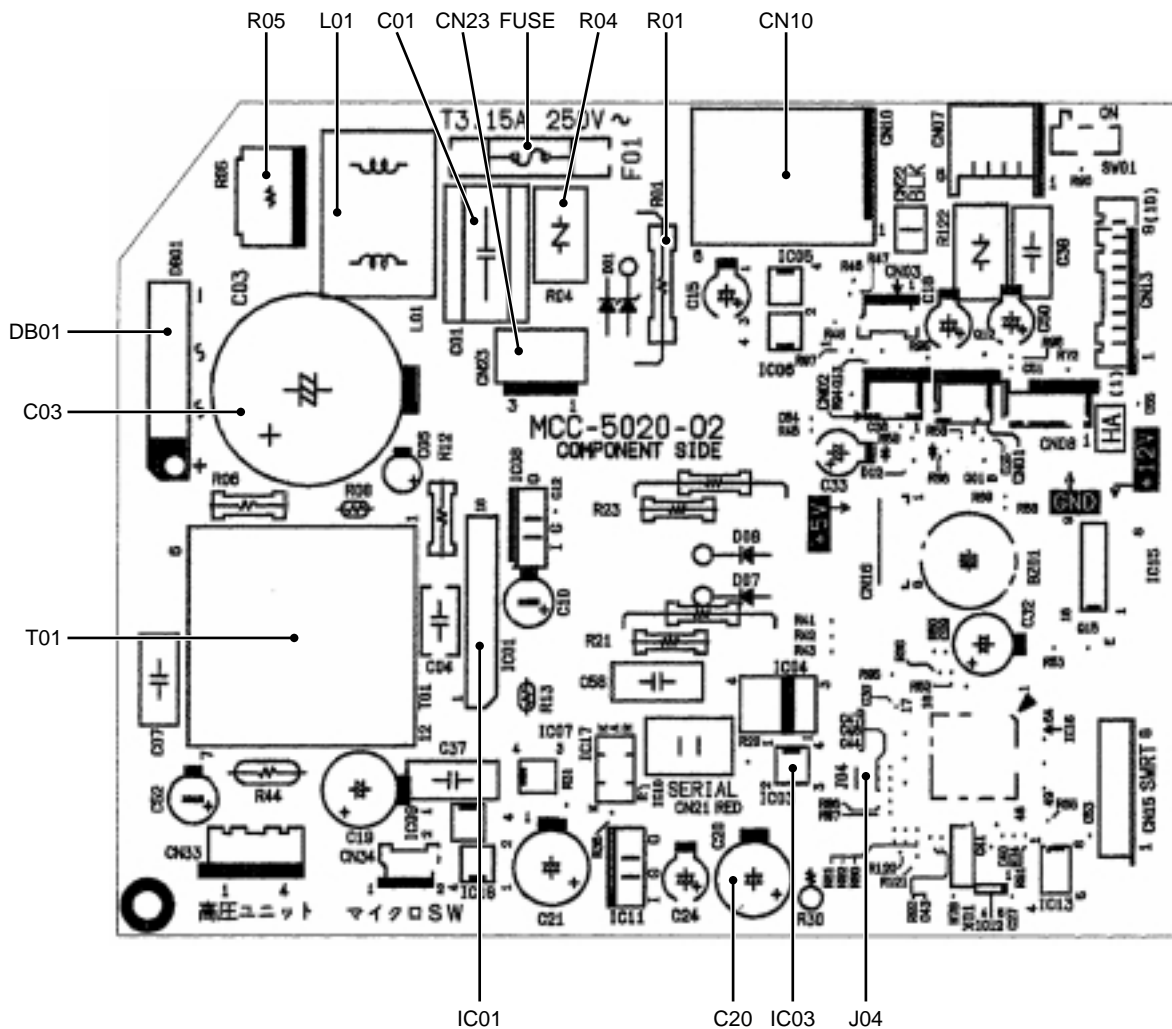

12-3. Outdoor Unit

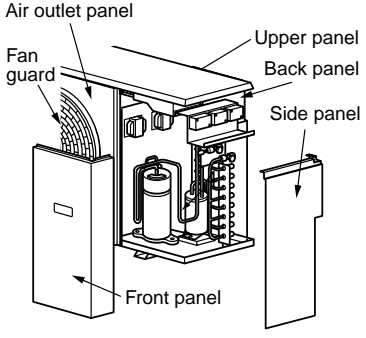
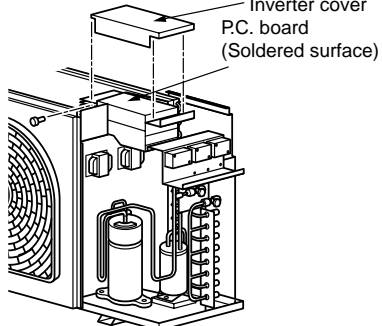
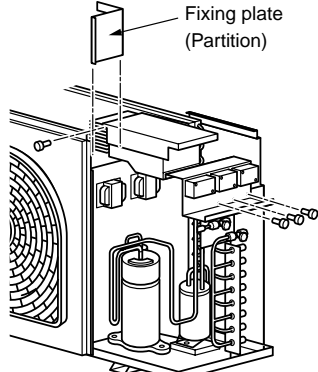
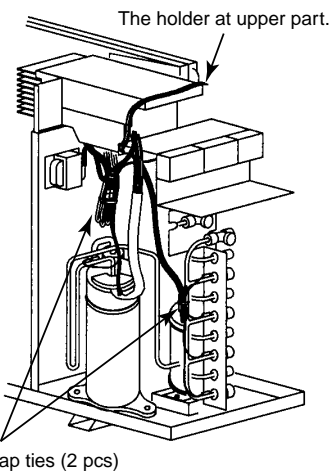
No.	Part name	Procedure	Remarks
①	Common procedure	<p>1. Detachment</p> <ol style="list-style-type: none"> 1) Stop operation of the air conditioner, and turn "OFF" the power breaker. 2) Remove the side panel. (Ø4 × 10L 3 pcs.) 3) Remove the cord clamp. (Ø4 × 14L 5 × 2 = 10 pcs.) Disconnect the connecting cables and power cord from the terminals. 4) Remove the upper panel. (Ø4 × 10L 6 pcs.) 5) Remove the front panel. (Ø4 × 10L 3 pcs.) 6) Remove the back panel. (Ø4 × 10L 6 pcs.) 7) Remove the air outlet panel. (Ø4 × 10L 8 pcs.) 	
②	Inverter assembly	<p>1. Detachment</p> <ol style="list-style-type: none"> 1) Perform work from item 1) to 5) of ①. 2) Remove screw (ST1T Ø4 × 10L 1 pc.) of the upper left part of the inverter cover. <ul style="list-style-type: none"> • If removing the inverter cover in this condition, P.C. board can be checked. • If there is no space in the upper part of the upper cabinet, perform work from 6) to 7) of ① and remove the partition fixing plate (ST1T Ø4 × 10L 1 pc.). <div style="border: 1px solid black; padding: 5px; margin: 10px 0;"> <p>Be careful to check the inverter because high-voltage circuit is incorporated in it.</p> </div> <ol style="list-style-type: none"> 3) Perform discharging by connecting the discharging resistance (approx. 100Ω 40W) or plug of soldering iron to ⊕, ⊖ terminals of the C15 (printed "CAUTION HIGH VOLTAGE" is attached.) electrolytic capacitor (760μF) on P.C. board. <div style="border: 1px solid black; padding: 5px; margin: 10px 0;"> <p>Be careful to discharge the capacitor because the electrolytic capacitor cannot naturally discharge and voltage remains according to trouble type in some cases.</p> </div> <div style="border: 1px solid black; padding: 5px; margin: 10px 0; text-align: center;"> <p>NOTE</p> </div> <div style="border: 1px solid black; padding: 5px; margin: 10px 0;"> <p>This capacitor is one with mass capacity. Therefore, it is dangerous that a large spark generates if short-circuiting between ⊕, ⊖ polarity with screwdriver, etc. for discharging.</p> </div> <ol style="list-style-type: none"> 4) Remove screw (Ø4 × 10L 2 pcs.) fixing the valve clamping plate/the inverter box, and fixing the back panel/the inverter box. 5) Remove various lead wires from the holder at upper part of the inverter box and cut 2 tie-lap ties binding each lead wires : 6) Pull the inverter box upward. 7) Disconnect connectors of various lead wires. 	  

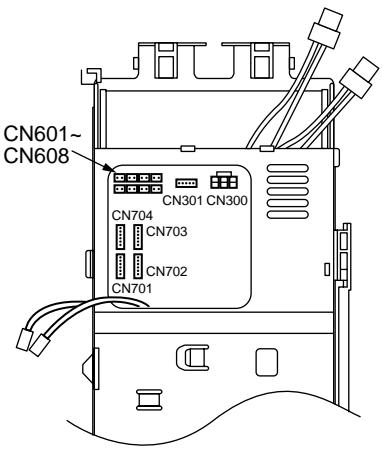
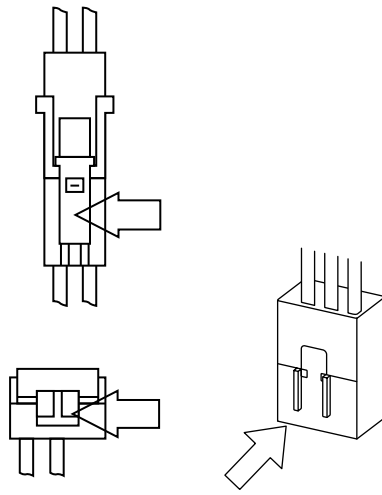
No.	Part name	Procedure	Remarks
③	Control board assembly	<ol style="list-style-type: none"> 1. Disconnect lead wires and connectors connected from the control board assembly to other parts. <ol style="list-style-type: none"> 1) Lead wires <ul style="list-style-type: none"> • Connection with terminal block : 7 wires (Red, Orange, Pink, Yellow, Black and two White wires) • Connection with compressor : Remove the fastons (3 places at compressor side). • Connection with reactor : Remove the connector from P08, 09 (2P, White) and P12, P13 (2P, Gray). • Connection with 4-way valve : Remove the connector (3P). • Connection with case thermo. : Remove the connector (2P). 2) Connectors <ul style="list-style-type: none"> • Sub-control board assembly side <ul style="list-style-type: none"> CN300 : Outdoor fan (3P, White) CN301 : Outdoor fan position detection (5P, White) CN601 : TO sensor (2P, White) CN602 : TD sensor (3P, White) CN603 : TS sensor (2P, Black) CN604 : TE sensor (2P, White) CN605 : TGa sensor (3P, Yellow) CN606 : TGb sensor (3P, White) CN607 : TGc sensor (3P, Green) CN608 : TGd sensor (2P, Blue) CN701 : A room pulse motor valve (6P, Yellow) CN702 : B room pulse motor valve (6P, White) CN703 : C room pulse motor valve (6P, Red) CN704 : D room pulse motor valve (6P, Blue) 2. Disconnect cable connecting the main control board assembly side and sub-control board assembly. <ul style="list-style-type: none"> • Main control board assembly side <ul style="list-style-type: none"> CN04 : Connecting cable (3P, White) CN05 : Connecting cable (2P, White) CN06 : Connecting cable (5P, Red) CN13 : Connecting cable (5P, Red) • Sub-control board assembly side <ul style="list-style-type: none"> CN302 : Connecting cable (3P, White) CN303 : Connecting cable (2P, White) CN501 : Connecting cable (3P, Red) CN800 : Connecting cable (5P, Red) 3. The connecting cable connecting compressor and P.C. board base and that connecting reactor and P.C. board base are fixed to the inverter box with bundling band. Cut off bundling band. 4. The connecting cables of the main P.C. board base and the sub-P.C. board base are fixed with bundling band. Cut off bundling band. 5. Remove the control board assembly from P.C. board base. <ol style="list-style-type: none"> 1) Main control board assembly side <ul style="list-style-type: none"> • Remove two claws of P.C. board base, and remove upward the heat sink by hands. • Remove three screws fixing the heat sink and main control board assembly side. • Remove red, orange, brown, and black connecting cables connected to the diode block. • Replace the P.C. board with a new one. 2) Sub-control board assembly side <ul style="list-style-type: none"> • Remove P.C. board base from the inverter box. • Remove three claws of P.C. board base, and replace the board with a new one. 	 <p>CN601~CN608</p> <p>CN704 CN301 CN300 CN703 CN702 CN701</p> <p>CN300, CN302, CN303, CN501, CN604, CN606, CN701, CN702, CN703, CN704, 4-way valve connector, case thermo. connector at the sub-control board assembly side are connectors with locks. Therefore, remove the connector while pushing the part indicated by an arrow.</p>  <p>P.C. board base P.C. board</p> <p>When mounting a new board, check that the board is correctly set in the groove of base holder of P.C. board base.</p>

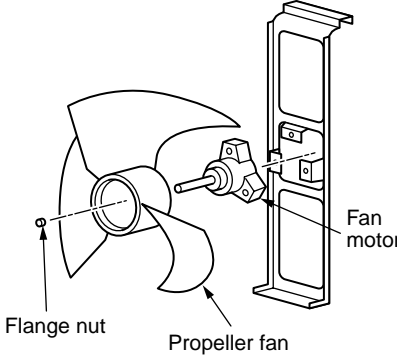
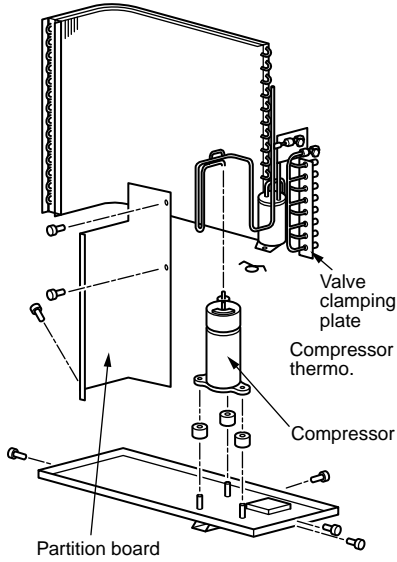
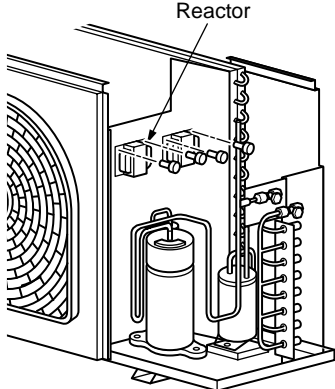
No.	Part name	Procedure	Remarks
④	Fan motor	<ol style="list-style-type: none"> 1) Perform work from item 1) to 5), 7) of ①. 2) Remove the flange nut fixing the fan motor and the propeller fan. <ul style="list-style-type: none"> • Flange nut is loosened by turning clockwise. (To tighten the flange nut, turn counterclock-wise.) 3) Remove the propeller fan. 4) Disconnect the connector for fan motor from the inverter. 5) Remove the fixing screws (3 pcs.), while holding by hands so that the fan motor does not fall. 	
⑤	Compressor	<ol style="list-style-type: none"> 1) Perform work of item ①, ②, and ④. 2) Evacuate refrigerant gas. 3) Remove the partition board. (Take care that the reactor and the partition fixing plate remain.) (Ø4 x 10L 3 pcs.) 4) Remove the sound-insulation materials. 5) Remove terminal cover of the compressor, and disconnect lead wires of the compressor and the compressor thermo. assembly from the terminal. 6) Remove pipes connected to the compressor with a burner. 7) Remove the fixing screws of the bottom plate and heat exchanger. (Ø4 x 10L 2 pcs.) 8) Remove the fixing screws of the bottom plate and valve clamping plate (Ø4 x 10L 2 pcs.), the accumulator fixing plate and the accumulator (Ø4 x 10L 2 pcs.). 9) Pull upward the refrigeration cycle. 10) Remove nut fixing the compressor on the bottom plate. 	
⑥	Reactor	<ol style="list-style-type: none"> 1) Perform work from item 1) to 5) of ① and ②. 2) Remove screws fixing the reactor. (Ø4 x 10L 2 pcs. for one reactor. One outdoor unit has two reactors on the partition.) 	

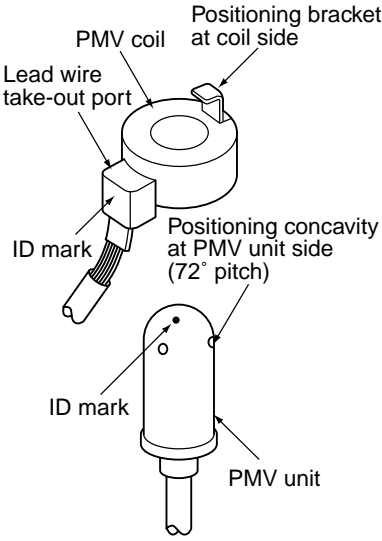
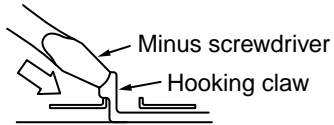
No.	Part name	Procedure	Remarks
⑦	Pulse motor valve coil	<p>1. Detachment</p> <ol style="list-style-type: none"> 1) Perform work of item ① and ②. 2) Release the coil from the notch by turning it, and remove coil from the pulse motor valve. <p>2. Attachment</p> <ol style="list-style-type: none"> 1) Put the coil deep into the bottom position. 2) Fix the coil firmly by turning it to the notch position. <div style="border: 1px solid black; padding: 5px; margin-top: 10px;"> <p>The pulse motor valve has A, B, C and D room side. After mounting it, check that coil at B room side (Nothing is marked on the pulse motor valve.) is connected to CN702.</p> <p>Check that coil at C room side (Red marking is marked on the pulse motor valve.) is connected to CN703. Check that coil at D room side (Blue marking is marked on the pulse motor valve) is connected to CN704 of the control board assembly respectively.</p> </div>	 <p style="text-align: center;">Mounting Method of Pulse Motor Valve (PMV) Coil</p> <p>Set the positioning bracket on the PMV coil to a concavity at PMV unit side and fix PMV coil. In this time, match color of ID mark at the coil side with that of ID mark at the PMV unit side. Make sure also that pipes do not deform when inserting and fixing the coil.</p>
⑧	Fan guard	<p>1. Detachment</p> <ol style="list-style-type: none"> 1) Perform work of item ①. 2) Remove the front cabinet, and put it down so that fan guard side directs downward. <div style="border: 1px solid black; padding: 5px; margin-top: 10px;"> <p>Perform work on a corrugated cardboard, cloth, etc. to prevent flaw to the product.</p> </div> <ol style="list-style-type: none"> 3) Remove the hooking claws by pushing minus screwdriver according to the arrow mark in the right figure, and remove the fan guard. <p>2. Attachment</p> <ol style="list-style-type: none"> 1) Insert claw of the fan guard in the hole of the air outlet panel. Push the hooking claws (5 positions) by hands and fix the claws. <div style="border: 1px solid black; padding: 5px; margin-top: 10px;"> <p>After all the attaching works are completed, check that all the hooking claws are fixed to the specified positions.</p> </div>	

No.	Part name	Procedure	Remarks																												
⑨	<p>Replacement of temperature sensor for servicing only</p> <p>Common service parts of sensor TO, TS, TE, TGa, TGb, TGc, TGd (without TD)</p> <p>These are parts for servicing sensors. Please check that the accessories shown in the right table are packed.</p>	<ol style="list-style-type: none"> 1) Cut the sensor 100 mm longer than old one. 2) Cut the protective tube after pulling out it (200 mm). 3) Move the protective tube toward the thermal sensor side and tear the tip of lead wire in two then strip the covering part. 4) Pass the stripped part through the thermal constrictive tube. 5) Cut the old sensor 100 mm length on the connector side, and recycle that connector. 6) Tear the lead wire in two on the connector side and strip the covering part. 7) Twist the leads on the connector and sensor sides, and solder them. 8) Move the thermal constrictive tubes toward the soldered parts and heat them with the dryer and constricting them. 9) Wind the attached color tape round the both terminals of the protective tube when colored protective tube is used. 10) Fix the sensor again. 	<p>Thermal sensor part Connector Cutting here 100</p> <p>200 Cutting here</p> <p>Thermal constrictive tube Cutting here 100</p> <p>15 70 Soldered part</p> <p>Dryer</p> <p>Winding the color tape</p>																												
		<p>NOTE</p> <ol style="list-style-type: none"> 1) Store the joint part of the sensor and the connector in the electric parts box. 2) Never joint them near the thermal sensor part. Otherwise it would cause insulation inferiority because of dew drops. 3) When replacing the sensor using the colored protective tube, wind the color tape matching the color of that tube. 																													
		<table border="1"> <thead> <tr> <th></th> <th>Parts name</th> <th>Q'ty</th> <th>Remarks</th> </tr> </thead> <tbody> <tr> <td>1</td> <td>Sensor</td> <td>1</td> <td>Length : 3m</td> </tr> <tr> <td>2</td> <td>Sensor Spring (A)</td> <td>1</td> <td>For spare</td> </tr> <tr> <td>3</td> <td>Sensor Spring (B)</td> <td>1</td> <td>For spare</td> </tr> <tr> <td>4</td> <td>Thermal constrictive tube</td> <td>3</td> <td>Including one spare</td> </tr> <tr> <td>5</td> <td>Color tape</td> <td>1</td> <td>9 colors</td> </tr> <tr> <td>6</td> <td>Terminal</td> <td>3</td> <td></td> </tr> </tbody> </table>		Parts name	Q'ty	Remarks	1	Sensor	1	Length : 3m	2	Sensor Spring (A)	1	For spare	3	Sensor Spring (B)	1	For spare	4	Thermal constrictive tube	3	Including one spare	5	Color tape	1	9 colors	6	Terminal	3		
	Parts name	Q'ty	Remarks																												
1	Sensor	1	Length : 3m																												
2	Sensor Spring (A)	1	For spare																												
3	Sensor Spring (B)	1	For spare																												
4	Thermal constrictive tube	3	Including one spare																												
5	Color tape	1	9 colors																												
6	Terminal	3																													

<MCC-1438>

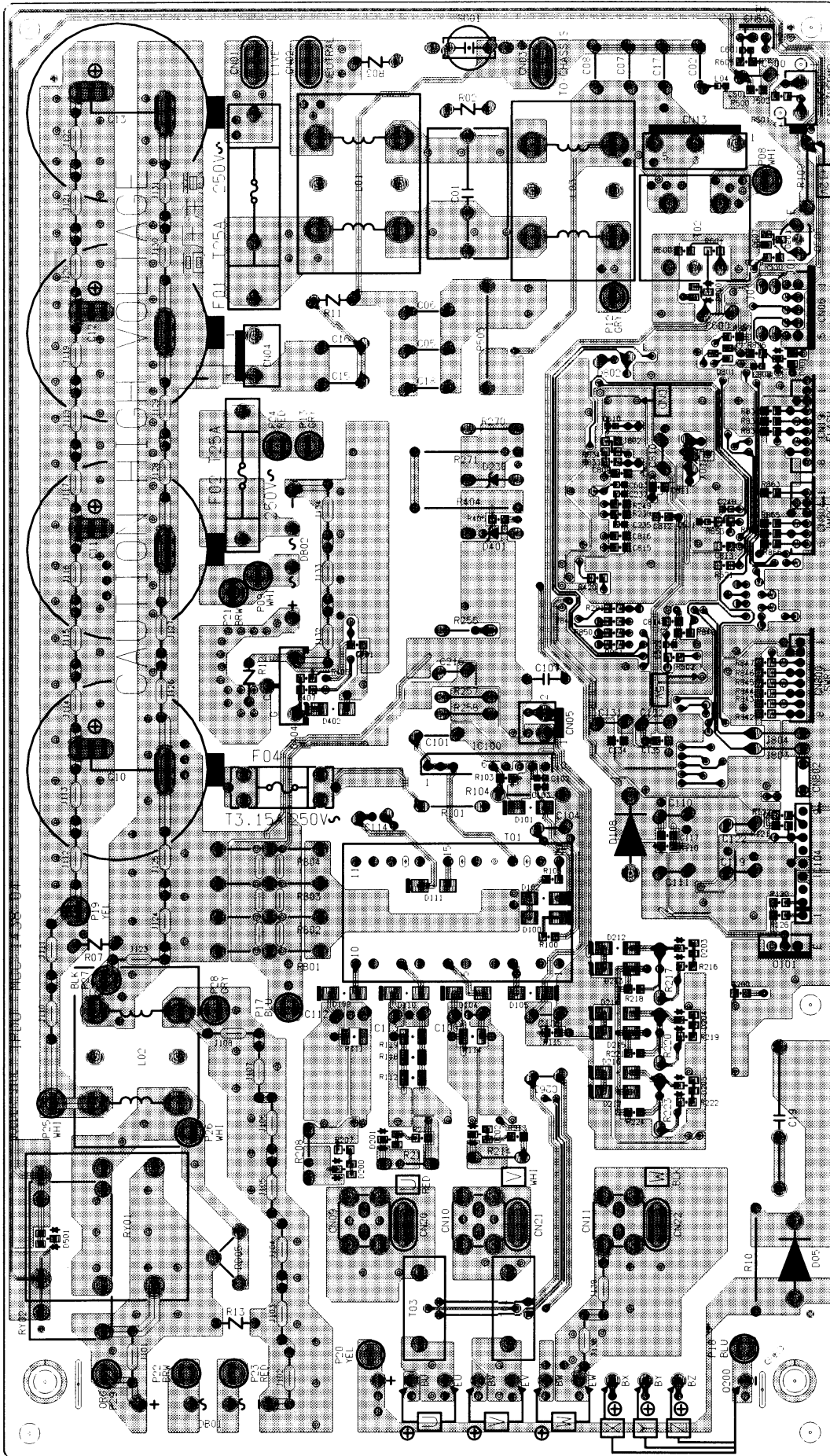

<MCC-818>

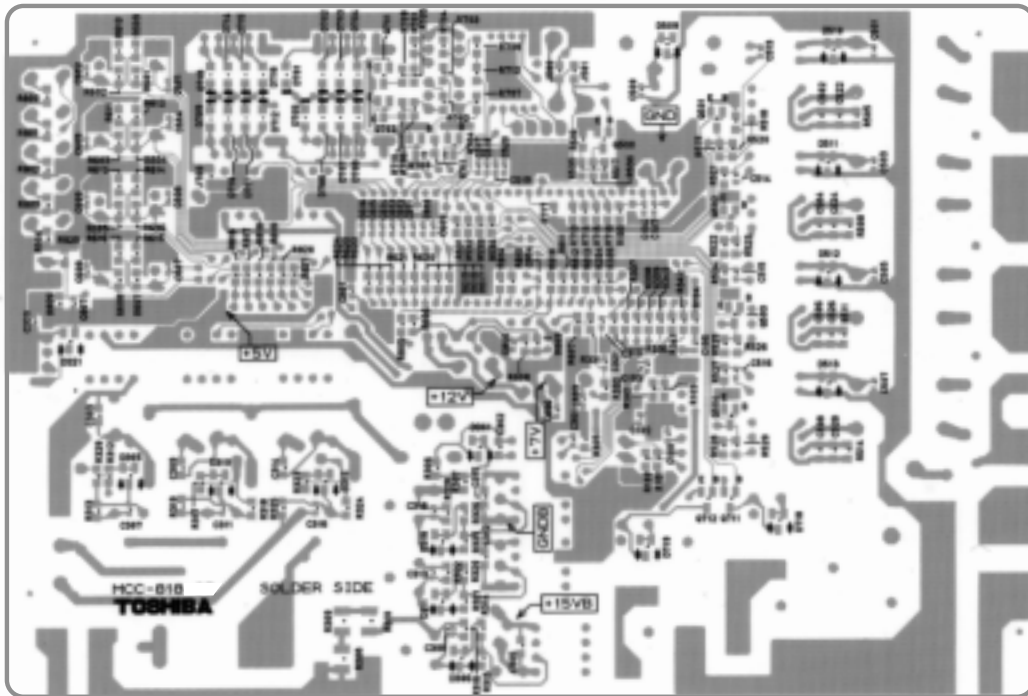

13. EXPLODED VIEWS AND PARTS LIST

13-1. Indoor Unit (1)

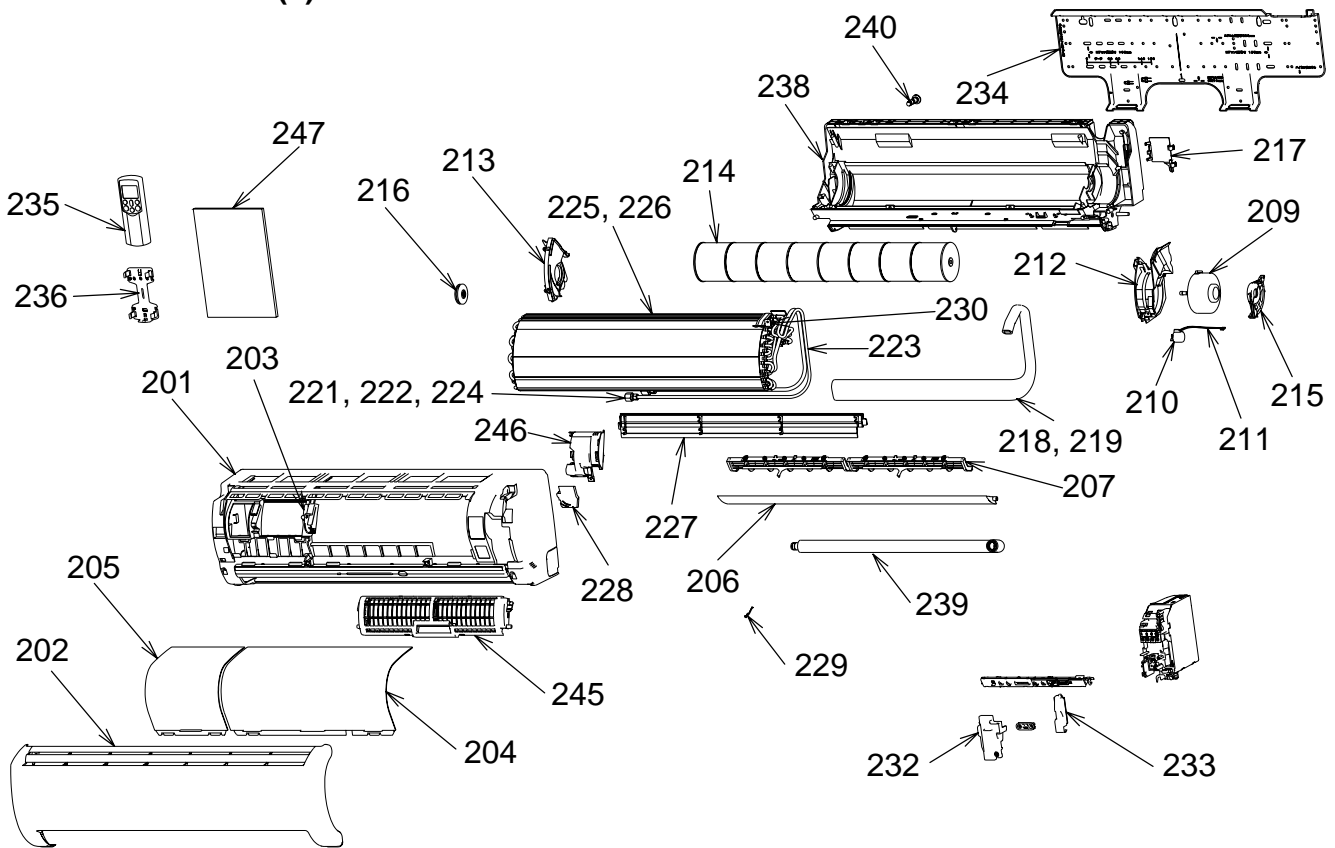

* The parts in the following parts list are conformed to RoHS.
Therefore be sure to use the following parts for repairing and replacing.

Location No.	Part No.	Description
201	43005633	Panel Ass'y, Front
202	43005610	Grille, Air Inlet
203	4301V052	Plate, Fix
204	43080512	Filter, Air, Right
205	43080521	Filter, Air, Left
206	43009675	Louver, Horizontal
207	43009682	Louver, Vertical
209	4302C067	Motor, Fan
210	4302C063	Motor, Louver
211	4306A024	Cord, Motor, Louver
212	43039363	Band, Motor, Left
213	43039321	Base, Bearing
214	43020346	Fan, Cross Flow
215	43039314	Band, Motor
216	43020253	Bearing
217	4301V028	Holder, Pipe
218	43049701	Pipe, Shield (*1)
219	43049698	Pipe, Shield (*2)
221	43047671	Pipe, Outlet (*2)
222	43047672	Pipe, Outlet (*1)
223	43049674	Spring, Suction (*1)

Location No.	Part No.	Description
224	43047673	Pipe, Inlet
225	43044803	Evaporator (*2)
226	43044804	Evaporator (*1)
227	43039324	Guide, Drain
228	43049728	Guide, Drain, Left
229	43019904	Holder, Sensor
230	43049770	Holder, Evaporator, Right
232	43062256	Cover, Terminal
233	43062247	Cover, Lead
234	43082293	Plate, Installation
235	4306S577	Remote Controller
236	43083071	Holder, Remote Comtroller
238	43003307	Body Ass'y, Back
239	43070188	Hose, Drain
240	43079268	Cap, Drain
245	43080516	Electrical Air Purifying Filter
246	43080527	Generator Ass'y, HV
247	4308N732	Owner's Manual

(*1) B16GKVP-E, M16GKCVP-E

(*2) B10GKVP-E, B13GKVP-E,
M10GKCVP-E, M13GKCVP-E

Indoor Unit (2)

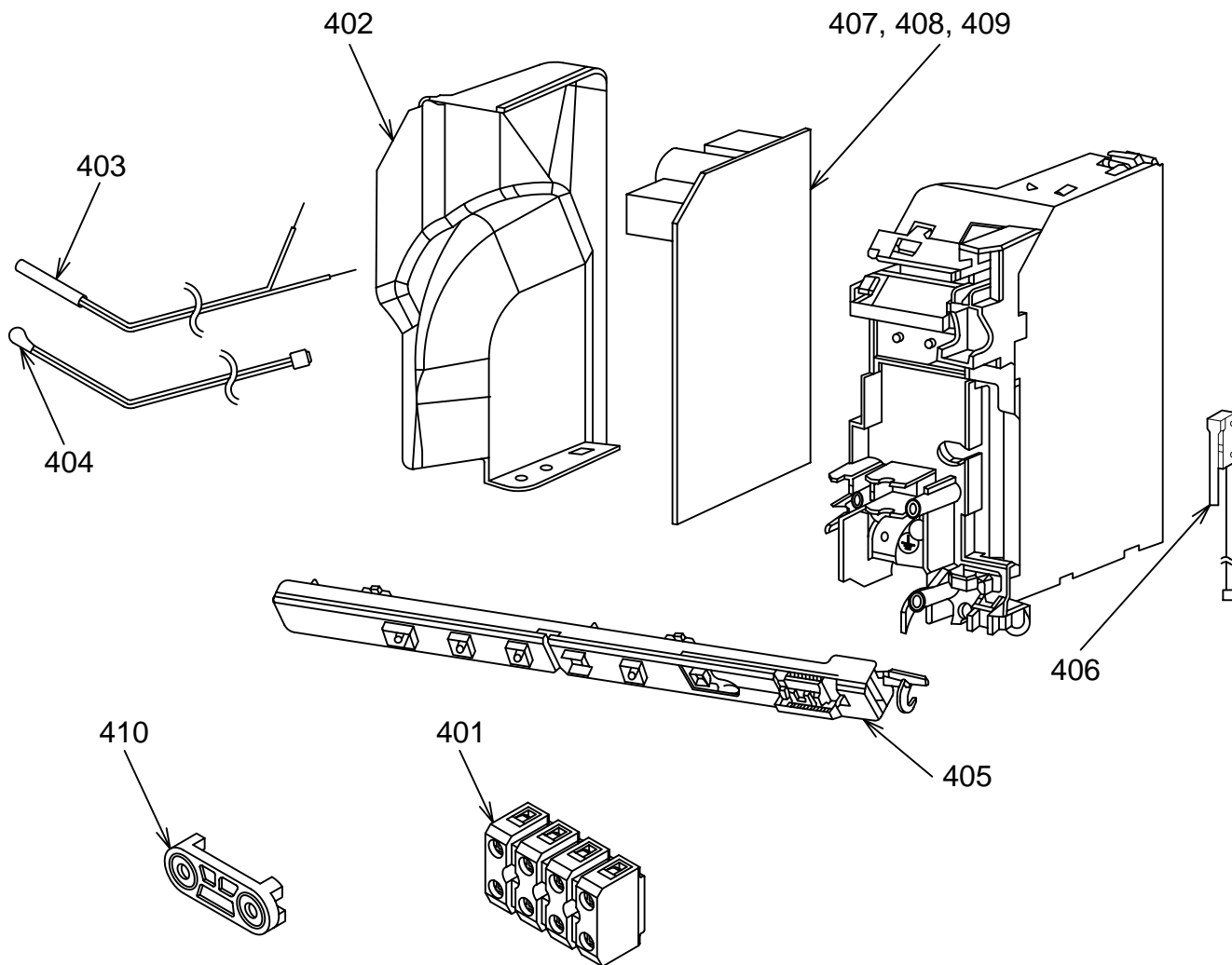

* The parts in the following parts list are conformed to RoHS.
Therefore be sure to use the following parts for repairing and replacing.

Location No.	Part No.	Description
401	4306A123	Terminal Block, 2P
402	43062263	Cover, E-Parts
403	43050425	Sensor, TC (F6)
404	43050426	Sensor, TA
405	4306S728	P.C. Board Ass'y, WRS-LED
406	43051346	SW-Micro Ass'y

Location No.	Part No.	Description
407	4306S709	P.C. Board Ass'y (B10GKVP-E, M10GKCVP-E)
408	4306S710	P.C. Board Ass'y (B13GKVP-E, M13GKCVP-E)
409	4306S711	P.C. Board Ass'y (B16GKVP-E, M16GKCVP-E)
410	43067115	Clamp, Cord

13-2. Outdoor Unit

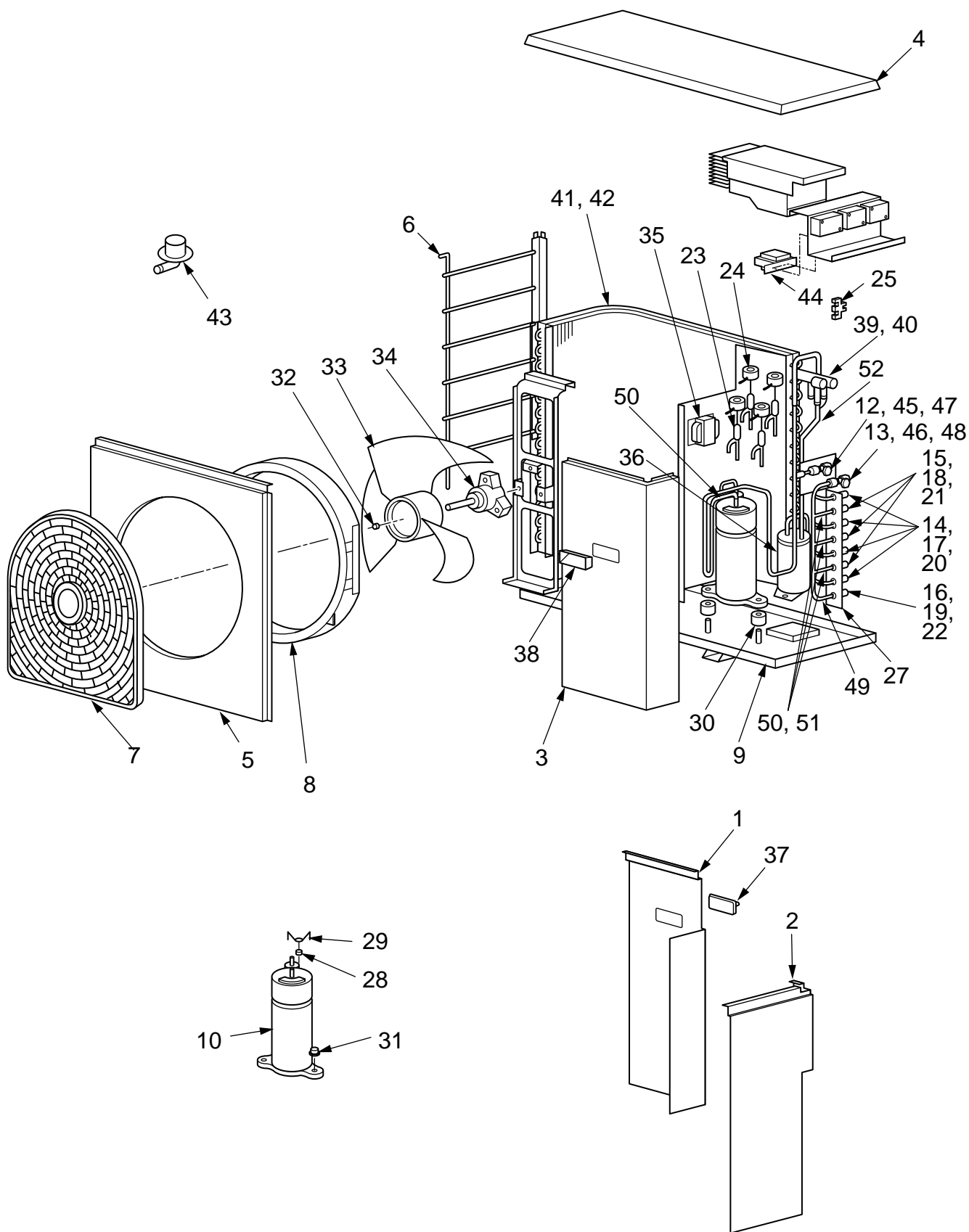

* The parts in the following parts list are conformed to RoHS.
Therefore be sure to use the following parts for repairing and replacing.

Location No.	Part No.	Description
1	43005640	Cabinet, Back Ass'y
2	43005641	Cabinet, Side Ass'y
3	43005639	Cabinet, Front Ass'y
4	43005643	Panel, Upper
5	43005635	Cabinet, Air, Outlet
6	43005489	Guard, Fin
7	43191651	Guard, Fan
8	43122065	Bell Mouth, Plastic
9	43042490	Base Ass'y
10	43041785	Compressor, DA220A2F-20L
12	43046442	Valve, Packed, 9.52
13	37546846	Valve, Packed, 12.7
14	43047684	Socket, 6.35
15	43047683	Socket, 9.52
16	43047682	Socket, 12.7
17	43147196	Bonnet, 1/4 IN
18	43047401	Bonnet, 3/8 IN
19	43047195	Bonnet, 1/2 IN
20	43047685	Nut, Flare, 1/4 IN
21	43047686	Nut, Flare, 3/8 IN
22	43047688	Nut, Flare, 1/2 IN
23	43046449	Valve, P.M.V., UKV-18D
24	43046448	Coil, P.M.V., UKV-U061E
25	43063332	Holder, Sensor, TO
28	43050407	Thermostat, Bimetal
29	43063317	Holder, Thermostat
30	43049739	Cushion, Rubber
31	43097212	Nut

Location No.	Part No.	Description
32	43047669	Nut, Flange
33	43120213	Fan, Propeller, PJ491
34	4302C069	Motor, Fan, DC, ICF-140-63-2R
35	43058276	Reactor, CH-47-Z-T
36	43048066	Accumulator Ass'y
37	4301V021	Hanger
38	43119390	Hanger
39	43046445	Valve, 4-way, STF-0213Z
40	43046443	Coil, 4-way, VHV
41	43043748	Condenser Ass'y (4M27GACV-E)
42	43043747	Condenser Ass'y (4M27GAV-E, 3M26GAV-E)
43	43032441	Nipple, Drain
44	43158192	Reactor, CH-43-Z-T
45	43047674	Cap, Charge, Port, 3/8 IN
46	43047675	Cap, Charge, Port, 1/2 IN
47	43047680	Cap, Valve, Packed, 3/8 IN
48	43047681	Cap, Valve, Packed, 1/2 IN
49	43019822	Holder, Sensor, Ø4 TGa (Heat Pump Model)
50	43063321	Holder, Sensor, Ø4 TGb, TGc, TGd (Heat Pump Model), TD
51	43063320	Holder, Sensor, Ø6 TGb, TGc, TGd (Cooling Only Model)
52	43019904	Holder, Sensor, Ø6 TE (Heat Pump Model), TS

No. 24 Coil, P.M.V. : For standardization of the servicing parts, one type only is provided.
Therefore, color of the connector may be different in replacement work.

13-3. P.C. Board Layout

RAS-4M27GAV-E

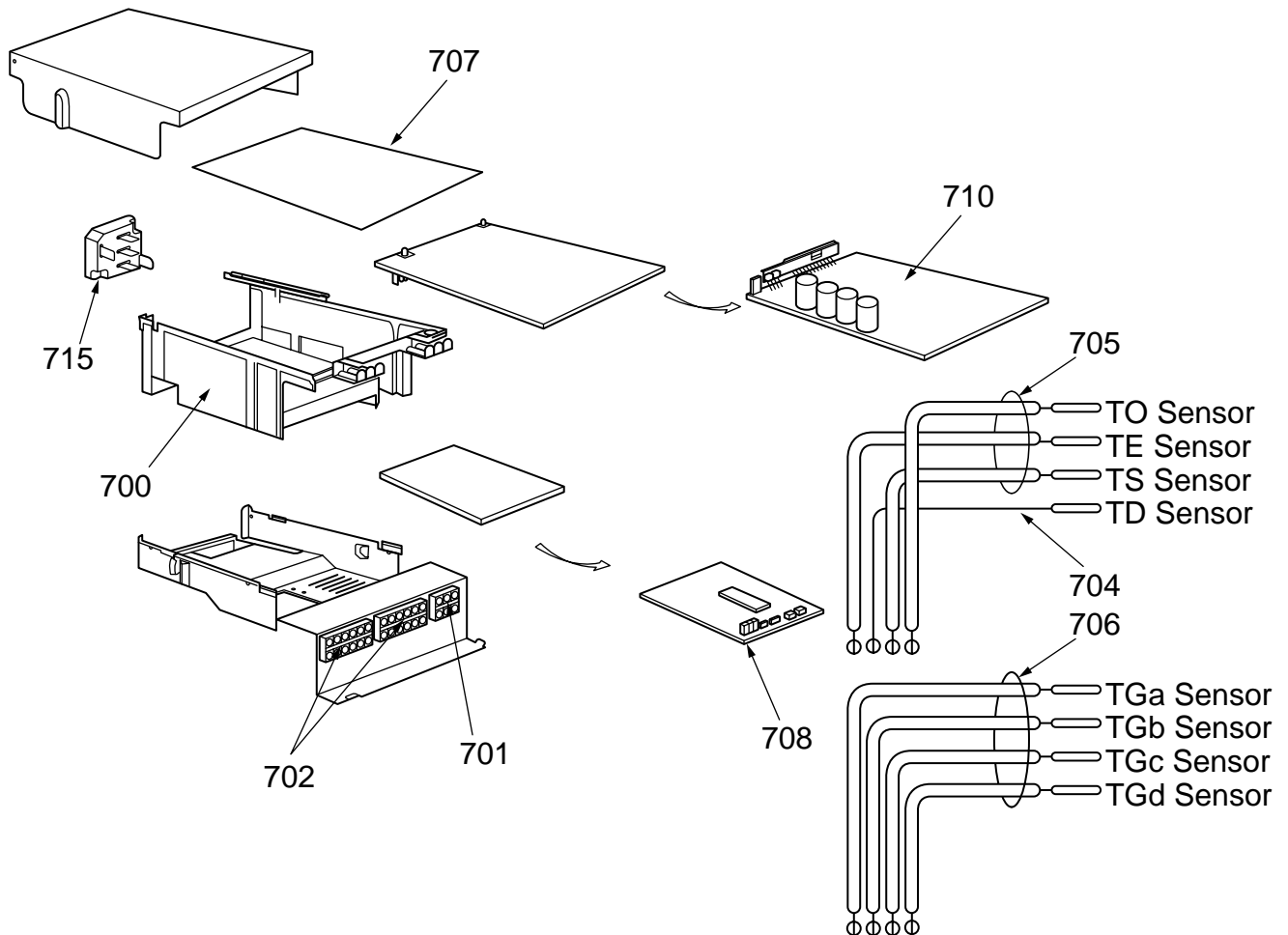

* The parts in the following parts list are conformed to RoHS.
Therefore be sure to use the following parts for repairing and replacing.

Location No.	Part No.	Description
700	43162042	Base, P.C. board, ABS
701	43160565	Terminal Block, 3P
702	43160566	Terminal Block, 6P, AC 250V, 20A
704	43050424	Sensor, TD (Ø4)
705	43050425	Sensor, TO, TE, TS (Ø6)

Location No.	Part No.	Description
706	43150320	Sensor, TG (Ø4)
707	4316V192	Plate
708	4306S689	P.C. board Ass'y, MCC-818 (4M27GAV-E)
710	4316V278	P.C. board Ass'y, IPDU, MCC-1438
715	43150259	Rectifier, 30A, 800V

RAS-4M27GACV-E

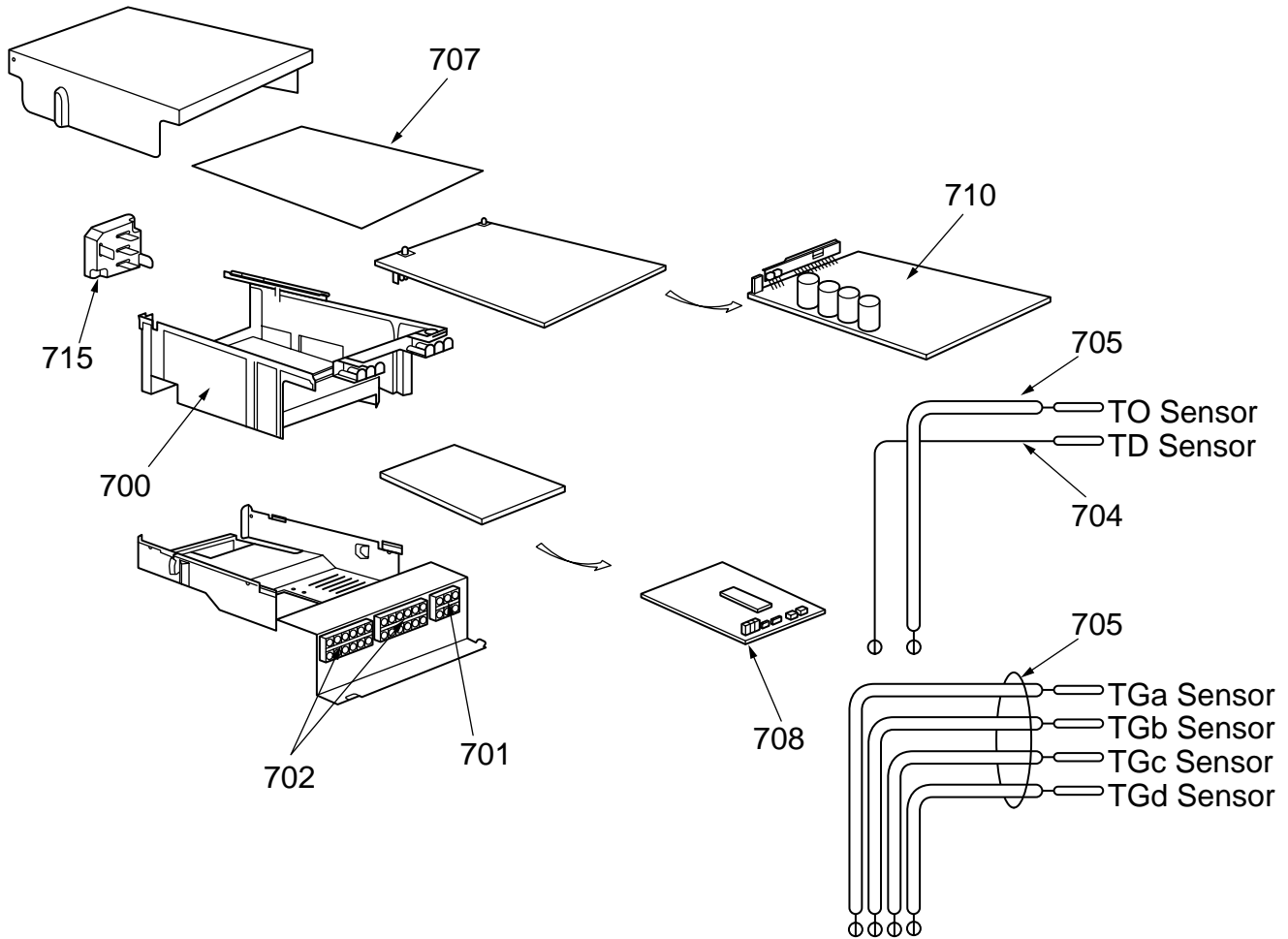

* The parts in the following parts list are conformed to RoHS.
Therefore be sure to use the following parts for repairing and replacing.

Location No.	Part No.	Description
700	43162042	Base, P.C. board, ABS
701	43160565	Terminal Block, 3P
702	43160566	Terminal Block, 6P, AC 250V, 20A
704	43050424	Sensor, TD (Ø4)
705	43050425	Sensor, TO, TG (Ø6)

Location No.	Part No.	Description
707	4316V192	Plate
708	4306S689	P.C. board Ass'y, MCC-818 (4M27GACV-E)
710	4316V278	P.C. board Ass'y, IPDU, MCC-1438
715	43150259	Rectifier, 30A, 800V

RAS-3M26GAV-E

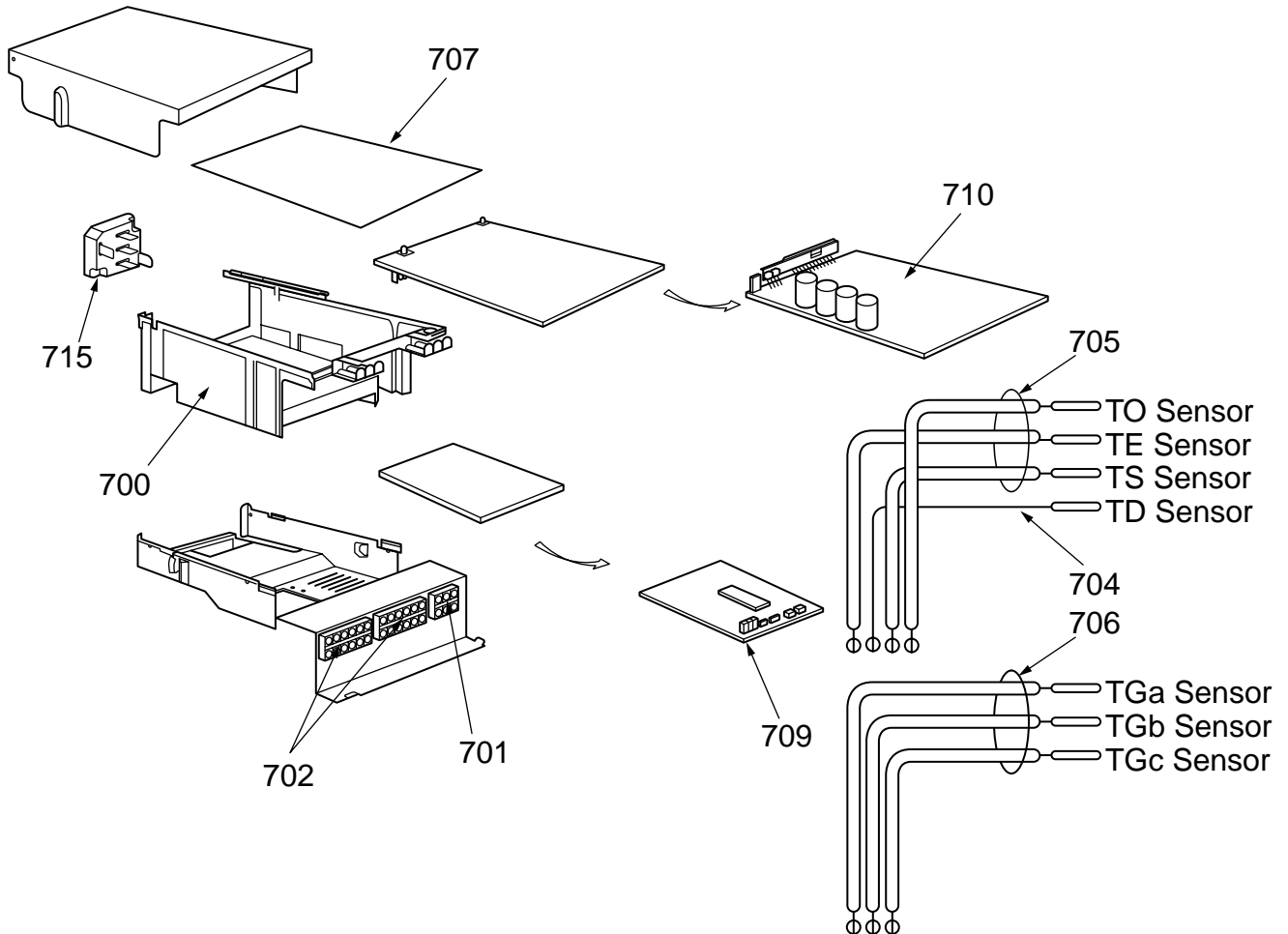

* The parts in the following parts list are conformed to RoHS.
Therefore be sure to use the following parts for repairing and replacing.

Location No.	Part No.	Description
700	43162042	Base, P.C. board, ABS
701	43160565	Terminal Block, 3P
702	43160566	Terminal Block, 6P, AC 250V, 20A
704	43050424	Sensor, TD (Ø4)
705	43050425	Sensor, TO, TE, TS (Ø6)

Location No.	Part No.	Description
706	43150320	Sensor, TG (Ø4)
707	4316V192	Plate
709	4306S690	P.C. board Ass'y, MCC-818 (3M26GAV-E)
710	4316V278	P.C. board Ass'y, IPDU, MCC-1438
715	43150259	Rectifier, 30A, 800V

This product is compliant with Directive 2002/95/EC, and cannot be disposed as unsorted municipal waste.

TOSHIBA CARRIER CORPORATION

2 CHOME 12-32, KONAN, MINATOKU, TOKYO, 108-0075, JAPAN

Copyright © 1999 to 2005 TOSHIBA CARRIER CORPORATION, ALL Rights Reserved.