

Service Manual

Air Conditioner



Indoor Unit
CS-VZ9SKE
CS-VZ12SKE

Outdoor Unit
CU-VZ9SKE
CU-VZ12SKE

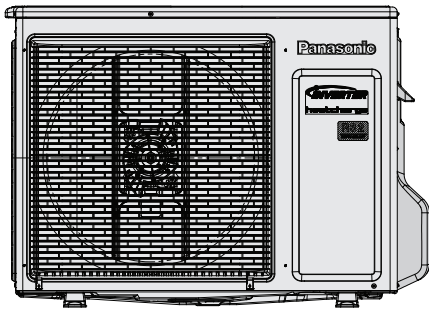

Destination
Europe

WARNING

This service information is designed for experienced repair technicians only and is not designed for use by the general public. It does not contain warnings or cautions to advise non-technical individuals of potential dangers in attempting to service a product. Products powered by electricity should be serviced or repaired only by experienced professional technicians. Any attempt to service or repair the product or products dealt with in this service information by anyone else could result in serious injury or death.

IMPORTANT SAFETY NOTICE

There are special components used in this equipment which are important for safety. These parts are marked by  in the Schematic Diagrams, Circuit Board Diagrams, Exploded Views and Replacement Parts List. It is essential that these critical parts should be replaced with manufacturer's specified parts to prevent shock, fire or other hazards. Do not modify the original design without permission of manufacturer.

CAUTION



R32 REFRIGERANT – This Air Conditioner contains and operates with refrigerant R32.
THIS PRODUCT MUST ONLY BE INSTALLED OR SERVICED BY QUALIFIED PERSONNEL.
 Refer to Commonwealth, State, Territory and local legislation, regulations, codes, installation & operation manuals, before the installation, maintenance and/or service of this product.

TABLE OF CONTENTS

	PAGE		PAGE
1. Safety Precautions	3	14.7 Timer Control	70
2. Precaution For Using R32 Refrigerant	6	14.8 Auto Restart Control	71
3. Specification	10	14.9 Menu Function	72
4. Features	16	14.10 Info Function	73
5. Location of Controls and Components	17	14.11 Indication Panel	73
5.1 Indoor Unit	17	14.12 nanoe Operation	74
5.2 Outdoor Unit	17	14.13 ODOR CLEANUP	75
5.3 Remote Control	18	14.14 +8/10°C Operation	76
6. Dimensions	19	14.15 Pre Heating Operation	77
6.1 Indoor Unit and Remote Control	19	14.16 AUTO COMFORT and ECONAVI Operation .	78
6.2 Outdoor Unit	20	15. Protection Control	86
7. Refrigeration Cycle Diagram	21	15.1 Protection Control for All Operations	86
7.1 Refrigerant Flow	22	15.2 Protection Control for Cooling and Dry	88
7.2 Deice Operation Flow	23	Operation	88
8. Block Diagram	25	15.3 Protection Control for Heating Operation ...	89
9. Wiring Connection Diagram	26	16. Servicing Mode	94
9.1 Indoor Unit	26	16.1 Auto OFF/ON Button (Indoor Unit)	94
9.2 Outdoor Unit	27	16.2 Remote Control Button	96
10. Electronic Circuit Diagram	28	17. Troubleshooting Guide	97
10.1 Indoor Unit	28	17.1 Refrigeration Cycle System	97
10.2 Outdoor Unit	29	17.2 Breakdown Self Diagnosis Function	99
11. Printed Circuit Board	30	17.3 Self Diagnosis Functions and Points of	101
11.1 Indoor Unit	30	Diagnosis	101
11.2 Outdoor Unit	32	17.4 Self-diagnosis Method	106
12. Installation Instruction	33	18. Disassembly and Assembly Instructions ...	135
12.1 Select The Best Location	33	18.1 Points of Disassembly (Indoor Unit)	135
12.2 Indoor Unit	34	18.2 Vertical Airflow Direction Louver	151
12.3 Outdoor Unit	38	18.3 Points of Disassembly (Outdoor Unit)	155
13. Installation and Servicing Air Conditioner		19. Technical Data	168
using R32	41	19.1 Cool Mode Performance Data	168
13.1 About R32 Refrigerant	41	19.2 Heat Mode Performance Data	169
13.2 Characteristics of R32 Refrigerant	41	20. Service Data	170
13.3 Refrigerant piping installation • Tools used in	43	20.1 Cool Mode Outdoor Air Temperature	170
services	43	Characteristic	170
13.4 New installation, Relocation, Repairing of	47	20.2 Heat Mode Outdoor Air Temperature	172
Refrigerant Cycle System The Procedures	47	Characteristic	172
13.5 Piping installation of R32	48	20.3 Piping Length Correction Factor	174
13.6 Installation, Relocation, and Service	49	21. Exploded View and Replacement Parts List	176
13.7 Repairing of refrigerant cycle / Brazing point .	53	21.1 Indoor Unit	176
.....	53	21.2 Outdoor Unit	179
13.8 <Reference> Analysis method for no error	59		
code, no cooling / no warming	59		
14. Operation Control	61		
14.1 Basic Function	61		
14.2 Indoor Fan Motor Operation	63		
14.3 Outdoor Fan Motor Operation	65		
14.4 Airflow Direction	66		
14.5 Quiet Operation	69		
14.6 Powerful Mode Operation	69		

1. Safety Precautions





- Read the following "SAFETY PRECAUTIONS" carefully before perform any servicing.
- Electrical work must be installed or serviced by a licensed electrician. Be sure to use the correct rating of the power plug and main circuit for the model installed.
- The caution items stated here must be followed because these important contents are related to safety. The meaning of each indication used is as below. Incorrect installation or servicing due to ignoring of the instruction will cause harm or damage, and the seriousness is classified by the following indications.

 WARNING	This indication shows the possibility of causing death or serious injury.
 CAUTION	This indication shows the possibility of causing injury or damage to properties.

- The items to be followed are classified by the symbols:









	This symbol denotes item that is PROHIBITED from doing.
---	---



- Explanation of symbols displayed on the indoor unit or outdoor unit.

 WARNING	This symbol shows that this equipment uses a flammable refrigerant. If the refrigerant is leaked, together with an external ignition source, there is a possibility of ignition.
 CAUTION	This symbol shows that the Operation Instructions should be read carefully.
 CAUTION	This symbol shows that a service personnel should be handling this equipment with reference to the Installation Instructions.
 CAUTION	This symbol shows that there is information included in the Operation Instructions and/or Installation Instructions.





- Carry out test run to confirm that no abnormality occurs after the servicing. Then, explain to user the operation, care and maintenance as stated in instructions. Please remind the customer to keep the operating instructions for future reference.

 WARNING	
1.	Do not modify the machine, part, material during repairing service.
2.	If wiring unit is supplied as repairing part, do not repair or connect the wire even only partial wire break. Exchange the whole wiring unit.
3.	Do not wrench the fasten terminal. Pull it out or insert it straightly.
4.	Engage authorized dealer or specialist for installation and servicing. If installation or servicing done by the user is defective, it will cause water leakage, electrical shock or fire.
5.	Install according to this installation instructions strictly. If installation is defective, it will cause water leakage, electrical shock or fire.
6.	The appliance shall be stored in a well ventilated room with floor area larger than 2.06 m ² and without any continuously operating ignition sources. Keep away from open flames, any operating gas appliances or any operating electric heater. Else, it may explode and cause injury or death.
7.	The appliance shall be installed, and/or operated in a room with floor area larger than 2.06 m ² and keep away from ignition sources, such as heat/sparks/open flame, or, hazardous areas, such as gas appliances, gas cooking, reticulated gas supply systems, or electric cooking appliances, etc.
8.	Use the attached accessories parts and specified parts for installation and servicing. Otherwise, it will cause the set to fall, water leakage, fire or electrical shock.
9.	Install at a strong and firm location which is able to withstand the set's weight. If the strength is not enough or installation is not properly done, the set will drop and cause injury.
10.	For electrical work, follow the local national wiring standard, regulation and the installation instruction. An independent circuit and single outlet must be used. If electrical circuit capacity is not enough or defect found in electrical work, it will cause electrical shock or fire.
11.	This equipment is strongly recommended to be installed with Earth Leakage Circuit Breaker (ELCB) or Residual Current Device (RCD), with sensitivity of 30mA at 0.1 sec or less. Otherwise, it may cause electrical shock and fire in case equipment breakdown or insulation breakdown.
12.	Do not use joint cable for indoor/outdoor connection cable. Use the specified indoor/outdoor connection cable, refer to installation instruction CONNECT THE CABLE TO THE INDOOR UNIT and connect tightly for indoor/outdoor connection. Clamp the cable so that no external force will be acted on the terminal. If connection or fixing is not perfect, it will cause heat up or fire at the connection.
13.	Wire routing must be properly arranged so that control board cover is fixed properly. If control board cover is not fixed perfectly, it will cause heat-up or fire at connection point of terminal, fire or electrical shock.
14.	Do not tie up the power supply cord into a bundle by band. Abnormal temperature rise on power supply cord may happen.

 WARNING	
15.	When install or relocate air conditioner, do not let any substance other than the specified refrigerant, eg. air etc. mix into refrigeration cycle (piping). (Mixing of air etc. will cause abnormal high pressure in refrigeration cycle and result in explosion, injury etc.).
16.	Do not install outdoor unit near handrail of veranda. When installing air-conditioner unit at veranda of high rise building, child may climb up to outdoor unit and cross over the handrail and causing accident.
17.	Do not pierce or burn as the appliance is pressurized. Do not expose the appliance to heat, flame, sparks, or other sources of ignition. Else, it may explode and cause injury or death.
18.	This equipment must be properly earthed. Earth line must not be connected to gas pipe, water pipe, earth of lightning rod and telephone. Otherwise, it may cause electrical shock in case equipment breakdown or insulation breakdown. 
19.	Keep away from small children, the thin film may cling to nose and mouth and prevent breathing. 
20.	Do not use unspecified cord, modified cord, joint cord or extension cord for power supply cord. Do not share the single outlet with other electrical appliances. Poor contact, poor insulation or over current will cause electrical shock or fire. 
21.	Tighten the flare nut with torque wrench according to specified method. If the flare nut is over-tightened, after a long period, the flare may break and cause refrigerant gas leakage. 
22.	<ul style="list-style-type: none"> • For R32 model, use piping, flare nut and tools which is specified for R32 refrigerant. Using of existing (R22) piping, flare nut and tools may cause abnormally high pressure in the refrigerant cycle (piping), and possibly result in explosion and injury. • Thickness of copper pipes used with R32 must be more than 0.8 mm. Never use copper pipes thinner than 0.8 mm. • It is desirable that the amount of residual oil less than 40 mg/10 m. 
23.	During installation, install the refrigerant piping properly before run the compressor. (Operation of compressor without fixing refrigeration piping and valves at opened condition will cause suck-in of air, abnormal high pressure in refrigeration cycle and result in explosion, injury etc.).
24.	Do not perform flare connection inside a building or dwelling or room, when joining the heat exchanger of indoor unit with interconnecting piping. Refrigerant connection inside a building or dwelling or room must be made by brazing or welding. Joint connection of indoor unit by flaring method can only be made at outdoor or at outside of a building or dwelling or room. Flare connection may cause gas leak and flammable atmosphere. 
25.	During pump down operation, stop the compressor before remove the refrigeration piping. (Removal of refrigeration piping while compressor is operating and valves are opened condition will cause suck-in of air, abnormal high pressure in refrigeration cycle and result in explosion, injury etc.).
26.	After completion of installation or service, confirm there is no leakage of refrigerant gas. It may generate toxic gas when the refrigerant contacts with fire.
27.	Ventilate if there is refrigerant gas leakage during operation. It may cause toxic gas when the refrigerant contacts with fire.
28.	Do not use means to accelerate the defrosting process or to clean, other than those recommended by the manufacturer. Any unfit method or using incompatible material may cause product damage, burst and serious injury.
29.	Be aware that refrigerants may not contain an odour.
30.	Do not insert your fingers or other objects into the unit, high speed run rotating fan may cause injury. 
31.	Must not use other parts except original parts describe in catalog and manual.
32.	Do not add or replace refrigerant other than specified type. It may cause product damage, burst and injury etc.

 CAUTION	
1.	Do not install the unit at place where leakage of flammable gas may occur. In case gas leaks and accumulates at surrounding of the unit, it may cause fire. 
2.	Carry out drainage piping as mentioned in installation instructions. If drainage is not perfect, water may enter the room and damage the furniture.
3.	Tighten the flare nut with torque wrench according to specified method. If the flare nut is over-tightened, after a long period, the flare may break and cause refrigerant gas leakage.
4.	Do not touch outdoor unit air inlet and aluminium fin. It may cause injury. 
5.	Select an installation location which is easy for maintenance. Incorrect installation, service or repair of this air conditioner may increase the risk of rupture and this may result in loss damage or injury and/or property.
6.	Pb free solder has a higher melting point than standard solder; typically the melting point is 50°F - 70°F (30°C - 40°C) higher. Please use a high temperature solder iron. In case of the soldering iron with temperature control, please set it to 700 ± 20°F (370 ± 10°C). Pb free solder will tend to splash when heated too high (about 1100°F / 600°C).

 **CAUTION**

7.	<p>Power supply connection to the room air conditioner. Use power supply cord 3 × 1.5 mm² type designation 60245 IEC 57 or heavier cord. Connect the power supply cord of the air conditioner to the mains using one of the following method. Power supply point should be in easily accessible place for power disconnection in case of emergency. In some countries, permanent connection of this air conditioner to the power supply is prohibited.</p> <p>1) Power supply connection to the receptacle using power plug. Use an approved 15/16A power plug with earth pin for the connection to the socket.</p> <p>2) Power supply connection to a circuit breaker for the permanent connection. Use an approved 16A circuit breaker for the permanent connection. It must be a double pole switch with a minimum 3.0 mm contact gap.</p>	
8.	<p>Do not release refrigerant during piping work for installation, servicing, reinstallation and during repairing a refrigerant parts. Take care of the liquid refrigerant, it may cause frostbite.</p>	
9.	<p>Prevent liquid or vapor from entering sumps or sewers since vapor is heavier than air and may form suffocating atmospheres.</p>	
10.	<p>Installation or servicing work: It may need two people to carry out the installation or servicing work.</p>	
11.	<p>Do not install this appliance in a laundry room or other location where water may drip from the ceiling, etc.</p>	
12.	<p>Do not sit or step on the unit, you may fall down accidentally.</p>	
13.	<p>Do not touch the sharp aluminum fins or edges of metal parts. If you are required to handle sharp parts during installation or servicing, please wear hand glove. Sharp parts may cause injury.</p>	

2. Precaution For Using R32 Refrigerant

- The basic installation work procedures are the same as conventional refrigerant (R410A, R22) models. However, pay careful attention to the following points:

 WARNING	
1.	Since the working pressure is higher than that of refrigerant R22 models, some of the piping and installation and service tools are special. (See "2.1. Special tools for R32 (R410A)".) Especially, when replacing a refrigerant R22 model with a new refrigerant R32 model, always replace the conventional piping and flare nuts with the R32 and R410A piping and flare nuts on the outdoor unit side. For R32 and R410A, the same flare nut on the outdoor unit side and pipe can be used.
2.	Models that use refrigerant R32 and R410A have a different charging port thread diameter to prevent erroneous charging with refrigerant R22 and for safety. Therefore, check beforehand. [The charging port thread diameter for R32 and R410A is 12.7 mm (1/2 inch).]
3.	Be more careful than R22 so that foreign matter (oil, water, etc.) does not enter the piping. Also, when storing the piping, securely seal the opening by pinching, taping, etc. (Handling of R32 is similar to R410A.)

 CAUTION	
1.	<p>Installation (Space)</p> <ul style="list-style-type: none"> Must ensure the installation of pipe-work shall be kept to a minimum. Avoid use dented pipe and do not allow acute bending. Must ensure that pipe-work shall be protected from physical damage. Must comply with national gas regulations, state municipal rules and legislation. Notify relevant authorities in accordance with all applicable regulations. <p>Must ensure mechanical connections be accessible for maintenance purposes.</p> <ul style="list-style-type: none"> In cases that require mechanical ventilation, ventilation openings shall be kept clear of obstruction. When disposal of the product, do follow to the precautions in #12 and comply with national regulations. Always contact to local municipal offices for proper handling. Interconnecting refrigerant pipework, i.e. pipework external to the unitary components, should be marked with a Class label (see Figure 9.1 of Code of Practice) every two metres where the pipework is visible. This includes pipework located in a ceiling space or any void which a person may access for maintenance or repair work within that space.
2.	<p>Servicing</p> <p>2-1. Service personnel</p> <ul style="list-style-type: none"> Any qualified person who is involved with working on or breaking into a refrigerant circuit should hold a current valid certificate from an industry-accredited assessment authority, which authorizes their competence to handle refrigerants safely in accordance with an industry recognised assessment specification. Servicing shall only be performed as recommended by the equipment manufacturer. Maintenance and repair requiring the assistance of other skilled personnel shall be carried out under the supervision of the person competent in the use of flammable refrigerants. Servicing shall be performed only as recommended by the manufacturer. <p>2-2. Work</p> <ul style="list-style-type: none"> Prior to beginning work on systems containing flammable refrigerants, safety checks are necessary to ensure that the risk of ignition is minimised. For repair to the refrigerating system, the precautions in #2-2 to #2-8 must be followed before conducting work on the system. Work shall be undertaken under a controlled procedure so as to minimize the risk of a flammable gas or vapor being present while the work is being performed. All maintenance staff and others working in the local area shall be instructed and supervised on the nature of work being carried out. Avoid working in confined spaces. Wear appropriate protective equipment, including respiratory protection, as conditions warrant. Ensure that the conditions within the area have been made safe by limit of use of any flammable material. Keep all sources of ignition and hot metal surfaces away. <p>2-3. Checking for presence of refrigerant</p> <ul style="list-style-type: none"> The area shall be checked with an appropriate refrigerant detector prior to and during work, to ensure the technician is aware of potentially flammable atmospheres. Ensure that the leak detection equipment being used is suitable for use with flammable refrigerants, i.e. non sparking, adequately sealed or intrinsically safe. In case of leakage/spillage happened, immediately ventilate area and stay upwind and away from spill/release. In case of leakage/spillage happened, do notify persons downwind of the leaking/spill, isolate immediate hazard area and keep unauthorized personnel out. <p>2-4. Presence of fire extinguisher</p> <ul style="list-style-type: none"> If any hot work is to be conducted on the refrigeration equipment or any associated parts, appropriate fire extinguishing equipment shall be available at hand. Have a dry powder or CO₂ fire extinguisher adjacent to the charging area.

 CAUTION

2-5. No ignition sources

- No person carrying out work in relation to a refrigeration system which involves exposing any pipe work that contains or has contained flammable refrigerant shall use any sources of ignition in such a manner that it may lead to the risk of fire or explosion. He/She must not be smoking when carrying out such work.
- All possible ignition sources, including cigarette smoking, should be kept sufficiently far away from the site of installation, repairing, removing and disposal, during which flammable refrigerant can possibly be released to the surrounding space.
- Prior to work taking place, the area around the equipment is to be surveyed to make sure that there are no flammable hazards or ignition risks.
- "No Smoking" signs shall be displayed.

2-6. Ventilated area

- Ensure that the area is in the open or that it is adequately ventilated before breaking into the system or conducting any hot work.
- A degree of ventilation shall continue during the period that the work is carried out.
- The ventilation should safely disperse any released refrigerant and preferably expel it externally into the atmosphere.

2-7. Checks to the refrigeration equipment

- Where electrical components are being changed, they shall be fit for the purpose and to the correct specification.
- At all times the manufacturer's maintenance and service guidelines shall be followed.
- If in doubt consult the manufacturer's technical department for assistance.
- The following checks shall be applied to installations using flammable refrigerants.
 - The charge size is in accordance with the room size within which the refrigerant containing parts are installed.
 - The ventilation machinery and outlets are operating adequately and are not obstructed.
 - If an indirect refrigerating circuit is being used, the secondary circuit shall be checked for the presence of refrigerant.
 - Marking to the equipment continues to be visible and legible. Markings and signs that are illegible shall be corrected.
 - Refrigeration pipe or components are installed in a position where they are unlikely to be exposed to any substance which may corrode refrigerant containing components, unless the components are constructed of materials which are inherently resistant to being corroded or are properly protected against being so corroded.

2-8. Checks to electrical devices

- Repair and maintenance to electrical components shall include initial safety checks and component inspection procedures.
- Initial safety checks shall include but not limit to:-
 - That capacitors are discharged: this shall be done in a safe manner to avoid possibility of sparking.
 - That there is no live electrical components and wiring are exposed while charging, recovering or purging the system.
 - That there is continuity of earth bonding.
- At all times the manufacturer's maintenance and service guidelines shall be followed.
- If in doubt consult the manufacturer's technical department for assistance.
- If a fault exists that could compromise safety, then no electrical supply shall be connected to the circuit until it is satisfactorily dealt with.
- If the fault cannot be corrected immediately but it is necessary to continue operation, an adequate temporary solution shall be used.
- The owner of the equipment must be informed or reported so all parties are advised thereafter.

Repairs to sealed components

- During repairs to sealed components, all electrical supplies shall be disconnected from the equipment being worked upon prior to any removal of sealed covers, etc.
 - If it is absolutely necessary to have an electrical supply to equipment during servicing, then a permanently operating form of leak detection shall be located at the most critical point to warn of a potentially hazardous situation.
 - Particular attention shall be paid to the following to ensure that by working on electrical components, the casing is not altered in such a way that the level of protection is affected. This shall include damage to cables, excessive number of connections, terminals not made to original specification, damage to seals, incorrect fitting of glands, etc.
3.
 - Ensure that apparatus is mounted securely.
 - Ensure that seals or sealing materials have not degraded such that they no longer serve the purpose of preventing the ingress of flammable atmospheres.
 - Replacement parts shall be in accordance with the manufacturer's specifications.

<p>NOTE: The use of silicon sealant may inhibit the effectiveness of some types of leak detection equipment. Intrinsicly safe components do not have to be isolated prior to working on them.</p>

Repair to intrinsically safe components

- Do not apply any permanent inductive or capacitance loads to the circuit without ensuring that this will not exceed the permissible voltage and current permitted for the equipment in use.
4.
 - Intrinsically safe components are the only types that can be worked on while live in the presence of a flammable atmosphere.
 - The test apparatus shall be at the correct rating.
 - Replace components only with parts specified by the manufacturer. Unspecified parts by manufacturer may result ignition of refrigerant in the atmosphere from a leak.

Cabling

5.
 - Check that cabling will not be subject to wear, corrosion, excessive pressure, vibration, sharp edges or any other adverse environmental effects.
 - The check shall also take into account the effects of aging or continual vibration from sources such as compressors or fans.

Detection of flammable refrigerants

6.
 - Under no circumstances shall potential sources of ignition be used in the searching or detection of refrigerant leaks.
 - A halide torch (or any other detector using a naked flame) shall not be used.

Leak detection methods

- Electronic leak detectors shall be used to detect flammable refrigerants, but the sensitivity may not be adequate, or may need re-calibration.
(Detection equipment shall be calibrated in a refrigerant-free area.)
 - Ensure that the detector is not a potential source of ignition and is suitable for the refrigerant used.
 - Leak detection equipment shall be set at a percentage of the LFL of the refrigerant and shall be calibrated to the refrigerant employed and the appropriate percentage of gas (25 % maximum) is confirmed
- 7.
- Leak detection fluids are suitable for use with most refrigerants but the use of detergents containing chlorine shall be avoided as the chlorine may react with the refrigerant and corrode the copper pipe-work.
 - If a leak is suspected, all naked flames shall be removed/extinguished.
 - If a leakage of refrigerant is found which requires brazing, all of the refrigerant shall be recovered from the system, or isolated (by means of shut off valves) in a part of the system remote from the leak. Oxygen free nitrogen (OFN) shall then be purged through the system both before and during the brazing process.

Removal and evacuation

- When breaking into the refrigerant circuit to make repairs – or for any other purpose – conventional procedures shall be used. However, it is important that best practice is followed since flammability is a consideration.
The following procedure shall be adhered to:

- remove refrigerant ->
- purge the circuit with inert gas ->
- evacuate ->
- purge again with inert gas ->
- open the circuit by cutting or brazing

- 8.
- The refrigerant charge shall be recovered into the correct recovery cylinders.
 - The system shall be “flushed” with OFN to render the unit safe.
 - This process may need to be repeated several times.
 - Compressed air or oxygen shall not be used for this task.
 - Flushing shall be achieved by breaking the vacuum in the system with OFN and continuing to fill until the working pressure is achieved, then venting to atmosphere, and finally pulling down to a vacuum.
 - This process shall be repeated until no refrigerant is within the system.
 - When the final OFN charge is used, the system shall be vented down to atmospheric pressure to enable work to take place.
 - This operation is absolutely vital if brazing operations on the pipe work are to take place.
 - Ensure that the outlet for the vacuum pump is not close to any ignition sources and there is ventilation available.

Charging procedures

- In addition to conventional charging procedures, the following requirements shall be followed.
 - Ensure that contamination of different refrigerants does not occur when using charging equipment.
 - Hoses or lines shall be as short as possible to minimize the amount of refrigerant contained in them.
 - Cylinders shall be kept upright.
 - Ensure that the refrigeration system is earthed prior to charging the system with refrigerant.
- 9.
- Label the system when charging is complete (if not already).
 - Extreme care shall be taken not to over fill the refrigeration system.
 - Prior to recharging the system it shall be pressure tested with OFN (refer to #7).
 - The system shall be leak tested on completion of charging but prior to commissioning.
 - A follow up leak test shall be carried out prior to leaving the site.
 - Electrostatic charge may accumulate and create a hazardous condition when charging and discharging the refrigerant.
To avoid fire or explosion, dissipate static electricity during transfer by grounding and bonding containers and equipment before charging/discharging.

Decommissioning

- Before carrying out this procedure, it is essential that the technician is completely familiar with the equipment and all its details.
- It is recommended good practice that all refrigerants are recovered safely.
- Prior to the task being carried out, an oil and refrigerant sample shall be taken in case analysis is required prior to re-use of reclaimed refrigerant.
- It is essential that electrical power is available before the task is commenced.
 - a) Become familiar with the equipment and its operation.
 - b) Isolate system electrically.
 - c) Before attempting the procedure ensure that:

- mechanical handling equipment is available, if required, for handling refrigerant cylinders;
- all personal protective equipment is available and being used correctly;
- the recovery process is supervised at all times by a competent person;
- recovery equipment and cylinders conform to the appropriate standards.

- 10.
- d) Pump down refrigerant system, if possible.
 - e) If a vacuum is not possible, make a manifold so that refrigerant can be removed from various parts of the system.
 - f) Make sure that cylinder is situated on the scales before recovery takes place.
 - g) Start the recovery machine and operate in accordance with manufacturer's instructions.
 - h) Do not over fill cylinders. (No more than 80 % volume liquid charge).
 - i) Do not exceed the maximum working pressure of the cylinder, even temporarily.
 - j) When the cylinders have been filled correctly and the process completed, make sure that the cylinders and the equipment are removed from site promptly and all isolation valves on the equipment are closed off.
 - k) Recovered refrigerant shall not be charged into another refrigeration system unless it has been cleaned and checked.
 - Electrostatic charge may accumulate and create a hazardous condition when charging or discharging the refrigerant.
To avoid fire or explosion, dissipate static electricity during transfer by grounding and bonding containers and equipment before charging/discharging.

 CAUTION

Labelling

- 11.
- Equipment shall be labelled stating that it has been de-commissioned and emptied of refrigerant.
 - The label shall be dated and signed.
 - Ensure that there are labels on the equipment stating the equipment contains flammable refrigerant.

Recovery

- 12.
- When removing refrigerant from a system, either for servicing or decommissioning, it is recommended good practice that all refrigerants are removed safely.
 - When transferring refrigerant into cylinders, ensure that only appropriate refrigerant recovery cylinders are employed.
 - Ensure that the correct number of cylinders for holding the total system charge are available.
 - All cylinders to be used are designated for the recovered refrigerant and labelled for that refrigerant (i.e. special cylinders for the recovery of refrigerant).
 - Cylinders shall be complete with pressure relief valve and associated shut-off valves in good working order.
 - Recovery cylinders are evacuated and, if possible, cooled before recovery occurs.
 - The recovery equipment shall be in good working order with a set of instructions concerning the equipment that is at hand and shall be suitable for the recovery of flammable refrigerants.
 - In addition, a set of calibrated weighing scales shall be available and in good working order.
 - Hoses shall be complete with leak-free disconnect couplings and in good condition.
 - Before using the recovery machine, check that it is in satisfactory working order, has been properly maintained and that any associated electrical components are sealed to prevent ignition in the event of a refrigerant release. Consult manufacturer if in doubt.
 - The recovered refrigerant shall be returned to the refrigerant supplier in the correct recovery cylinder, and the relevant Waste Transfer Note arranged.
 - Do not mix refrigerants in recovery units and especially not in cylinders.
 - If compressors or compressor oils are to be removed, ensure that they have been evacuated to an acceptable level to make certain that flammable refrigerant does not remain within the lubricant.
 - The evacuation process shall be carried out prior to returning the compressor to the suppliers.
 - Only electric heating to the compressor body shall be employed to accelerate this process.
 - When oil is drained from a system, it shall be carried out safely.

3. Specification

Model		Indoor	CS-VZ9SKE				
		Outdoor	CU-VZ9SKE				
Performance Test Condition		JIS, ErP					
Power Supply		Phase, Hz	Single, 50				
		V	230				
		Min.	Mid.	Max.			
Cooling	Capacity		kW	0.60	2.50	3.00	
	Running Current		A	—	2.05	—	
	Input Power		W	140	430	660	
	Annual Consumption		W	—	215k	—	
	EER		W/W	—	5.81	—	
	ErP	Pdsign		kW	—	2.5	—
		SEER		(W/W)	—	10.5	—
		Annual Consumption		kWh	—	83	—
		Class			—	A+++	—
	Power Factor		%	—	91	—	
	Indoor Noise (H / L / QLo)		dB-A	44 / 27 / 18			
			Power Level dB	59 / - / -			
	Outdoor Noise (H / L)		dB-A	49			
			Power Level dB	64			
Heating	Capacity		kW	0.60	3.60	7.90	
	Running Current		A	—	3.10	—	
	Input Power		W	140	640	2.72k	
	COP		W/W	—	5.63	—	
	ErP warm/ ave./ cold	Pdsign		kW	3.6		
		Tbivalent		°C	-10		
		SCOP		(W/W)	6.2		
		Annual Consumption		kWh	812		
		Class			A+++		
	Power Factor		%	—	91	—	
	Indoor Noise (H / L / QLo)		dB-A	44 / 26 / 18			
			Power Level dB	59 / - / -			
	Outdoor Noise (H / L)		dB-A	49			
			Power Level dB	64			
Max Current (A) / Max Input Power (W)		15.0 / 3.45k					
Starting Current (A)		3.1					
Compressor	Type		Hermetic Motor (Rotary)				
	Motor Type		Brushless (6-poles)				
	Output Power		W	900			

Model			Indoor	CS-VZ9SKE	
			Outdoor	CU-VZ9SKE	
Indoor Fan	Type			Cross-flow fan	
	Material			AS+GF Resin	
	Motor Type			DC, Transistor (8-poles)	
	Input Power		W	40.4	
	Output Power		W	40	
	Speed	QLo	Cool	rpm	530
			Heat	rpm	500
		Lo	Cool	rpm	600
			Heat	rpm	650
		Me	Cool	rpm	880
			Heat	rpm	950
		Hi	Cool	rpm	1010
			Heat	rpm	1110
	Shi	Cool	rpm	1070	
Heat		rpm	—		
Outdoor Fan	Type			Propeller Fan + Flat piece	
	Material			PP	
	Motor Type			DC Brushless (8-poles)	
	Input Power		W	46.00	
	Output Power		W	40	
	Speed	Hi	Cool	rpm	900
Heat			rpm	—	
Moisture Removal			L/h	1.5 (3.2)	
Indoor Airflow	QLo	Cool	m ³ /min (ft ³ /m)	4.7 (166)	
		Heat	m ³ /min (ft ³ /m)	5.5 (194)	
	Lo	Cool	m ³ /min (ft ³ /m)	5.8 (205)	
		Heat	m ³ /min (ft ³ /m)	8.0 (283)	
	Me	Cool	m ³ /min (ft ³ /m)	10.4 (367)	
		Heat	m ³ /min (ft ³ /m)	12.9 (456)	
	Hi	Cool	m ³ /min (ft ³ /m)	12.5 (441)	
		Heat	m ³ /min (ft ³ /m)	15.5 (547)	
Shi	Cool	m ³ /min (ft ³ /m)	13.5 (477)		
	Heat	m ³ /min (ft ³ /m)	—		
Outdoor Airflow	Hi	Cool	m ³ /min (ft ³ /m)	33.1 (1169)	
		Heat	m ³ /min (ft ³ /m)	33.1 (1169)	
Refrigeration Cycle	Control Device			Expansion Valve	
	Refrigerant Oil		cm ³	FW50S (450)	
	Refrigerant Type			R32	
	Pre charged / Maximum charge		g (oz)	1.05k (37.0) / 1.20k (42.3)	
F-gas	Pre charged / Maximum charge		ton	0.709 / 0.810	
	GWP			675	
Dimension	Height (I/D / O/D)		mm (inch)	295 (11-39/64) / 630 (24-51/64)	
	Width (I/D / O/D)		mm (inch)	798 (31-27/64) / 799 (31-29/64)	
	Depth (I/D / O/D)		mm (inch)	375 (14-49/64) / 299 (11-49/64)	
Weight	Net (I/D / O/D)		kg (lb)	14.5 (32) / 39.5 (87)	

Model		Indoor	CS-VZ9SKE	
		Outdoor	CU-VZ9SKE	
Piping	Pipe Diameter (Liquid / Gas)	mm (inch)	6.35 (1/4) / 9.52 (3/8)	
	Standard length	m (ft)	5.0 (16.4)	
	Length range (min – max)	m (ft)	3 (9.8) ~ 15 (49.2)	
	I/D & O/D Height different	m (ft)	5.0 (16.4)	
	Additional Gas Amount	g/m (oz/ft)	20 (0.2)	
	Length for Additional Gas	m (ft)	7.5 (24.6)	
Drain Hose	Inner Diameter	mm	16.2	
	Length	mm	650	
Indoor Heat Exchanger	Fin Material		Aluminium (Pre Coat)	
	FPI		20.5	
Outdoor Heat Exchanger	Fin Material		Aluminium (Pre Coat)	
	Fin Type		Corrugated Fin (2LT-C6S-L)	
	Row × Stage × FPI		2 × 32 × 19	
	Size (W × H × D)	mm	809.5:789.7 × 586.24 × 25.2	
Power Supply			Indoor Power Supply	
Power Supply Cord		A	Nil	
Thermostat			Electronic Control	
Protection Device			Electronic Control	
			DRY BULB	WET BULB
Indoor Operation Range	Cooling	Maximum	32	23
		Minimum	16	11
	Heating	Maximum	30	—
		Minimum	16	—
	+8/10°C HEAT	Maximum	10	—
		Minimum	16	—
Outdoor Operation Range	Cooling	Maximum	43	26
		Minimum	-10	—
	Heating	Maximum	24	18
		Minimum	-30	—
	+8/10°C HEAT	Maximum	—	—
		Minimum	-30	—

1. Cooling capacities are based on indoor temperature of 27°C Dry Bulb (80.6°F Dry Bulb), 19.0°C Wet Bulb (66.2°F Wet Bulb) and outdoor air temperature of 35°C Dry Bulb (95°F Dry Bulb), 24°C Wet Bulb (75.2°F Wet Bulb).
2. Heating capacities are based on indoor temperature of 20°C Dry Bulb (68°F Dry Bulb) and outdoor air temperature of 7°C Dry Bulb (44.6°F Dry Bulb), 6°C Wet Bulb (42.8°F Wet Bulb).
3. Specifications are subjected to change without prior notice for further improvement.

Model		Indoor	CS-VZ12SKE				
		Outdoor	CU-VZ12SKE				
Performance Test Condition			JIS, ErP				
Power Supply		Phase, Hz	Single, 50				
		V	230				
			Min.	Mid.	Max.		
Cooling	Capacity		kW	0.60	3.50	4.00	
	Running Current		A	—	3.7	—	
	Input Power		W	140	800	980	
	Annual Consumption		W	—	400k	—	
	EER		W/W	—	4.38	—	
	ErP	Pdsign		kW	—	3.50	—
		SEER		(W/W)	—	10.0	—
		Annual Consumption		kWh	—	122	—
		Class			—	A+++	—
	Power Factor		%	—	95	—	
	Indoor Noise (H / L / QLo)		dB-A	45 / 33 / 18			
			Power Level dB	60 / - / -			
	Outdoor Noise (H / L)		dB-A	50			
			Power Level dB	65			
Heating	Capacity		kW	0.63	4.20	9.20	
	Running Current		A	—	3.80	—	
	Input Power		W	140	830	3.16k	
	COP		W/W	—	5.06	—	
	ErP warm/ave./cold	Pdsign		kW	4.2		
		Tbivalent		°C	-10		
		SCOP		(W/W)	5.9		
		Annual Consumption		kWh	995		
		Class			A+++		
	Power Factor		%	—	95	—	
	Indoor Noise (H / L / QLo)		dB-A	45 / 29 / 18			
			Power Level dB	60 / - / -			
	Outdoor Noise (H / L)		dB-A	50			
			Power Level dB	65			
Max Current (A) / Max Input Power (W)			15.0 / 3.45k				
Starting Current (A)			3.8				
Compressor	Type		Hermetic Motor (Rotary)				
	Motor Type		Brushless (6-poles)				
	Output Power		W	900			

Model			Indoor	CS-VZ12SKE	
			Outdoor	CU-VZ12SKE	
Indoor Fan	Type			Cross-flow fan	
	Material			AS+GF Resin	
	Motor Type			DC, Transistor (8-poles)	
	Input Power		W	44.1	
	Output Power		W	40	
	Speed	QLo	Cool	rpm	590
			Heat	rpm	500
		Lo	Cool	rpm	600
			Heat	rpm	650
		Me	Cool	rpm	950
			Heat	rpm	1000
		Hi	Cool	rpm	1040
			Heat	rpm	1140
	Shi	Cool	rpm	1100	
Heat		rpm	—		
Outdoor Fan	Type			Propeller Fan + Flat piece	
	Material			PP	
	Motor Type			DC Brushless (8-poles)	
	Input Power		W	48.68	
	Output Power		W	40	
	Speed	Hi	Cool	rpm	960
			Heat	rpm	—
Moisture Removal			L/h	2.0 (4.2)	
Indoor Airflow	QLo	Cool	m ³ /min (ft ³ /m)	5.6 (198)	
		Heat	m ³ /min (ft ³ /m)	5.5 (194)	
	Lo	Cool	m ³ /min (ft ³ /m)	8.2 (290)	
		Heat	m ³ /min (ft ³ /m)	9.0 (318)	
	Me	Cool	m ³ /min (ft ³ /m)	11.5 (406)	
		Heat	m ³ /min (ft ³ /m)	13.6 (480)	
	Hi	Cool	m ³ /min (ft ³ /m)	12.9 (456)	
		Heat	m ³ /min (ft ³ /m)	15.9 (562)	
	Shi	Cool	m ³ /min (ft ³ /m)	13.9 (491)	
		Heat	m ³ /min (ft ³ /m)	—	
Outdoor Airflow	Hi	Cool	m ³ /min (ft ³ /m)	35.4 (1250)	
		Heat	m ³ /min (ft ³ /m)	33.9 (1197)	
Refrigeration Cycle	Control Device			Expansion Valve	
	Refrigerant Oil		cm ³	FW50S (450)	
	Refrigerant Type			R32	
	Pre charged / Maximum charge		g (oz)	1.10k (38.8) / 1.25k (44.1)	
F-gas	Pre charged / Maximum charge		ton	0.743 / 0.844	
	GWP			675	
Dimension	Height (I/D / O/D)		mm (inch)	295 (11-39/64) / 630 (24-51/64)	
	Width (I/D / O/D)		mm (inch)	798 (31-27/64) / 799 (31-29/64)	
	Depth (I/D / O/D)		mm (inch)	375 (14-49/64) / 299 (11-49/64)	
Weight	Net (I/D / O/D)		kg (lb)	14.5 (32) / 39.5 (87)	

Model		Indoor	CS-VZ12SKE	
		Outdoor	CU-VZ12SKE	
Piping	Pipe Diameter (Liquid / Gas)	mm (inch)	6.35 (1/4) / 9.52 (3/8)	
	Standard length	m (ft)	5.0 (16.4)	
	Length range (min – max)	m (ft)	3 (9.8) ~ 15 (49.2)	
	I/D & O/D Height different	m (ft)	5.0 (16.4)	
	Additional Gas Amount	g/m (oz/ft)	20 (0.2)	
	Length for Additional Gas	m (ft)	7.5 (24.6)	
Drain Hose	Inner Diameter	mm	16.2	
	Length	mm	650	
Indoor Heat Exchanger	Fin Material		Aluminium (Pre Coat)	
	FPI		20.5	
Outdoor Heat Exchanger	Fin Material		Aluminium (Pre Coat)	
	Fin Type		Corrugated Fin (2LT-C6S-L)	
	Row × Stage × FPI		2 × 32 × 19	
	Size (W × H × D)	mm	809.5:789.7 × 586.24 × 25.2	
Power Supply			Indoor Power Supply	
Power Supply Cord		A	Nil	
Thermostat			Electronic Control	
Protection Device			Electronic Control	
			DRY BULB	WET BULB
Indoor Operation Range	Cooling	Maximum	32	23
		Minimum	16	11
	Heating	Maximum	30	—
		Minimum	16	—
	+8/10°C HEAT	Maximum	10	—
		Minimum	16	—
Outdoor Operation Range	Cooling	Maximum	43	26
		Minimum	-10	—
	Heating	Maximum	24	18
		Minimum	-30	—
	+8/10°C HEAT	Maximum	—	—
		Minimum	-30	—

1. Cooling capacities are based on indoor temperature of 27°C Dry Bulb (80.6°F Dry Bulb), 19.0°C Wet Bulb (66.2°F Wet Bulb) and outdoor air temperature of 35°C Dry Bulb (95°F Dry Bulb), 24°C Wet Bulb (75.2°F Wet Bulb).
2. Heating capacities are based on indoor temperature of 20°C Dry Bulb (68°F Dry Bulb) and outdoor air temperature of 7°C Dry Bulb (44.6°F Dry Bulb), 6°C Wet Bulb (42.8°F Wet Bulb).
3. Specifications are subjected to change without prior notice for further improvement.

4. Features

- **Inverter Technology**
 - Wider output power range
 - Energy saving
 - Quick Cooling
 - Quick Heating
 - More precise temperature control
- **Environment Protection**
 - Econavi
- **Long Installation Piping**
 - Long piping up to 15 meters during single split connection only
- **Easy to use remote control**
 - Press Individual operation mode button to ON
 - Press OFF button to OFF
- **Quality Improvement**
 - Random auto restart after power failure for safety restart operation
 - Gas leakage protection
 - Prevent compressor reverse cycle
 - Inner protector to protect compressor
 - Noise prevention during dry operation
- **Operation Improvement**
 - Quiet mode to reduce the indoor unit operating sound
 - Powerful mode to reach the desired room temperature quickly
 - 24-hour timer setting
 - Dual timer setting (Timer 1, Timer 2)
 - Pre Heating operation
 - Air purifying operation (nanoe)
 - High heating performance (Non Stop (Heating) Deicing)
 - Aluminium electric heater and base pan electric heater
 - +8/10°C HEAT operation is designed to provide heating at low temperature settings. It is used in houses unoccupied during winter, for the purpose of protecting equipment or housing appliances which may be destroyed by extreme cold weather
- **Serviceability Improvement**
 - Breakdown Self Diagnosis function
 - Demo mode
 - Service check mode

5. Location of Controls and Components

5.1 Indoor Unit

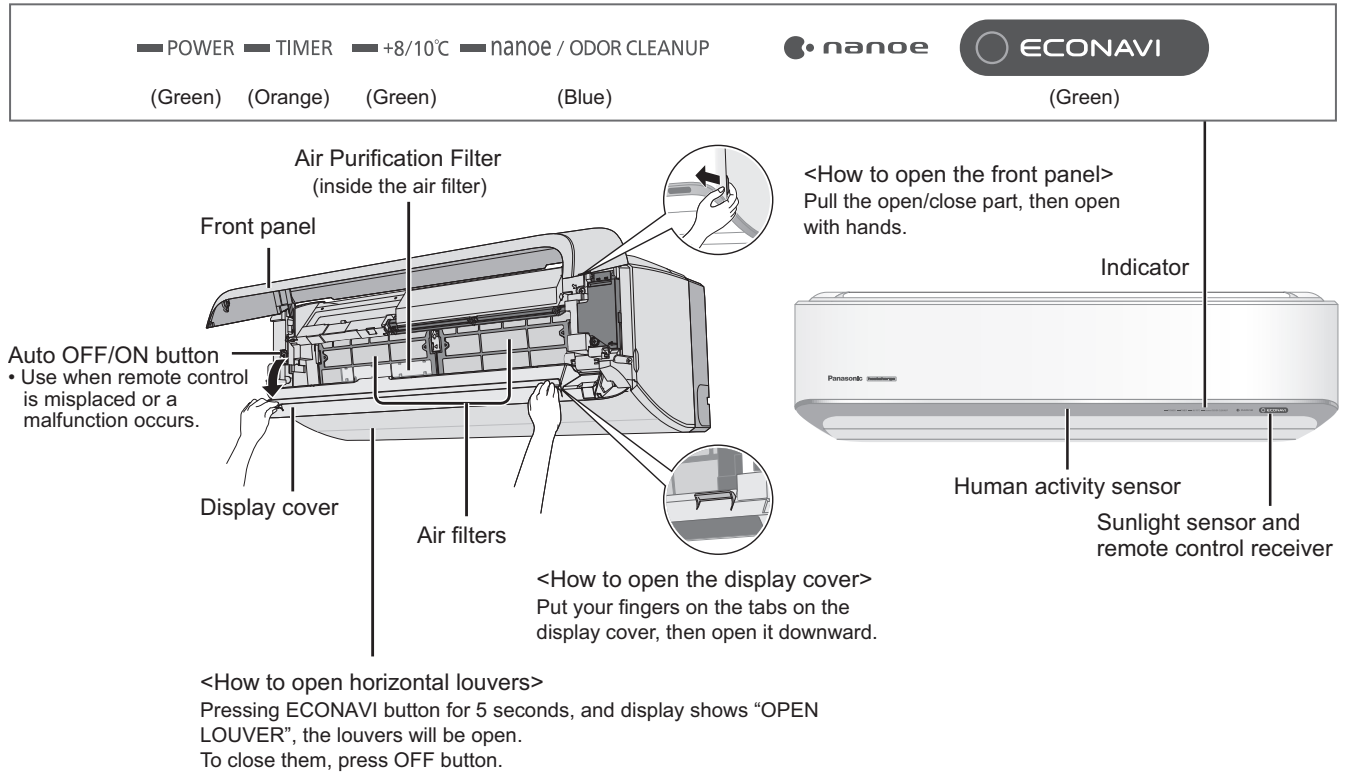

5.2 Outdoor Unit

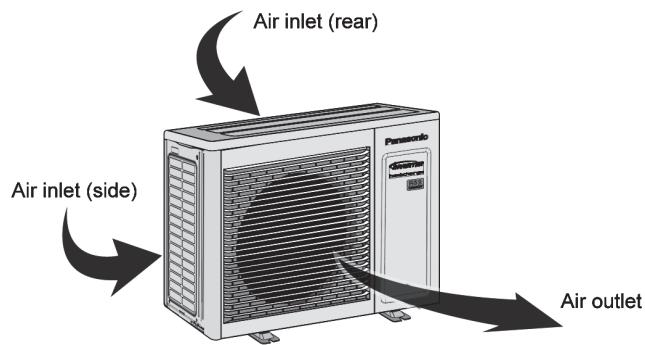

5.3 Remote Control

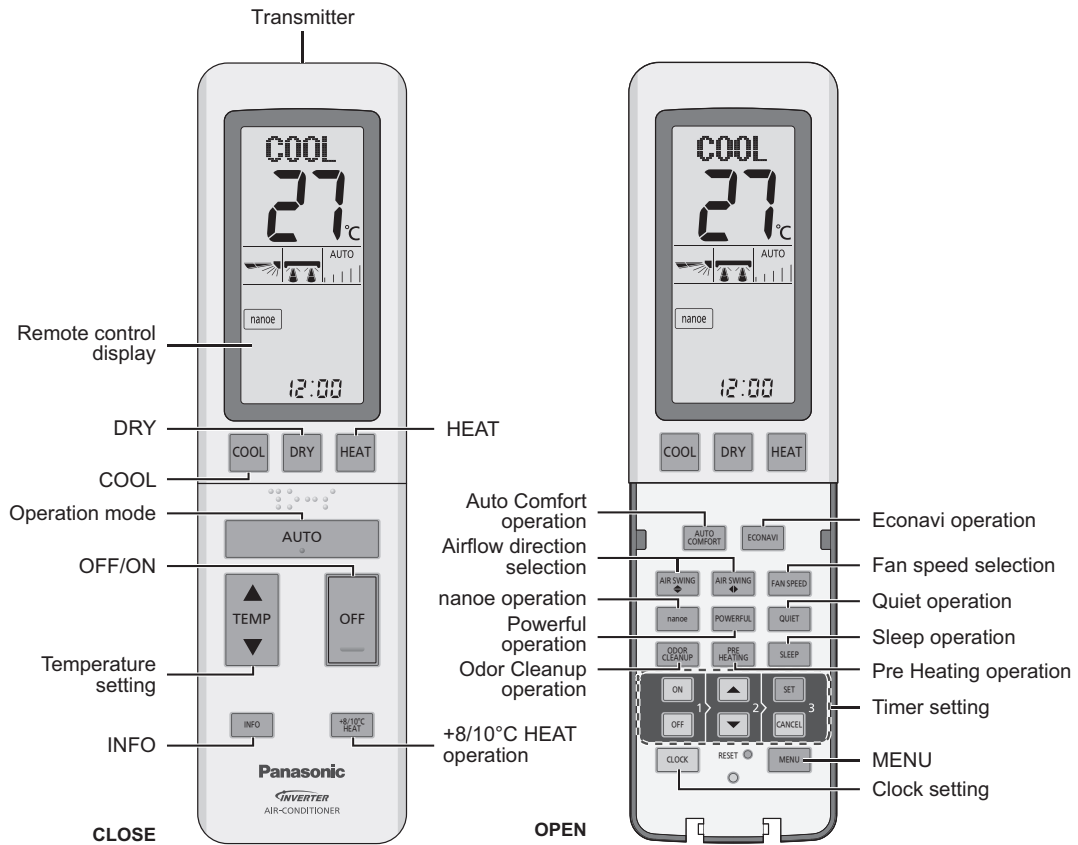

6. Dimensions

6.1 Indoor Unit and Remote Control

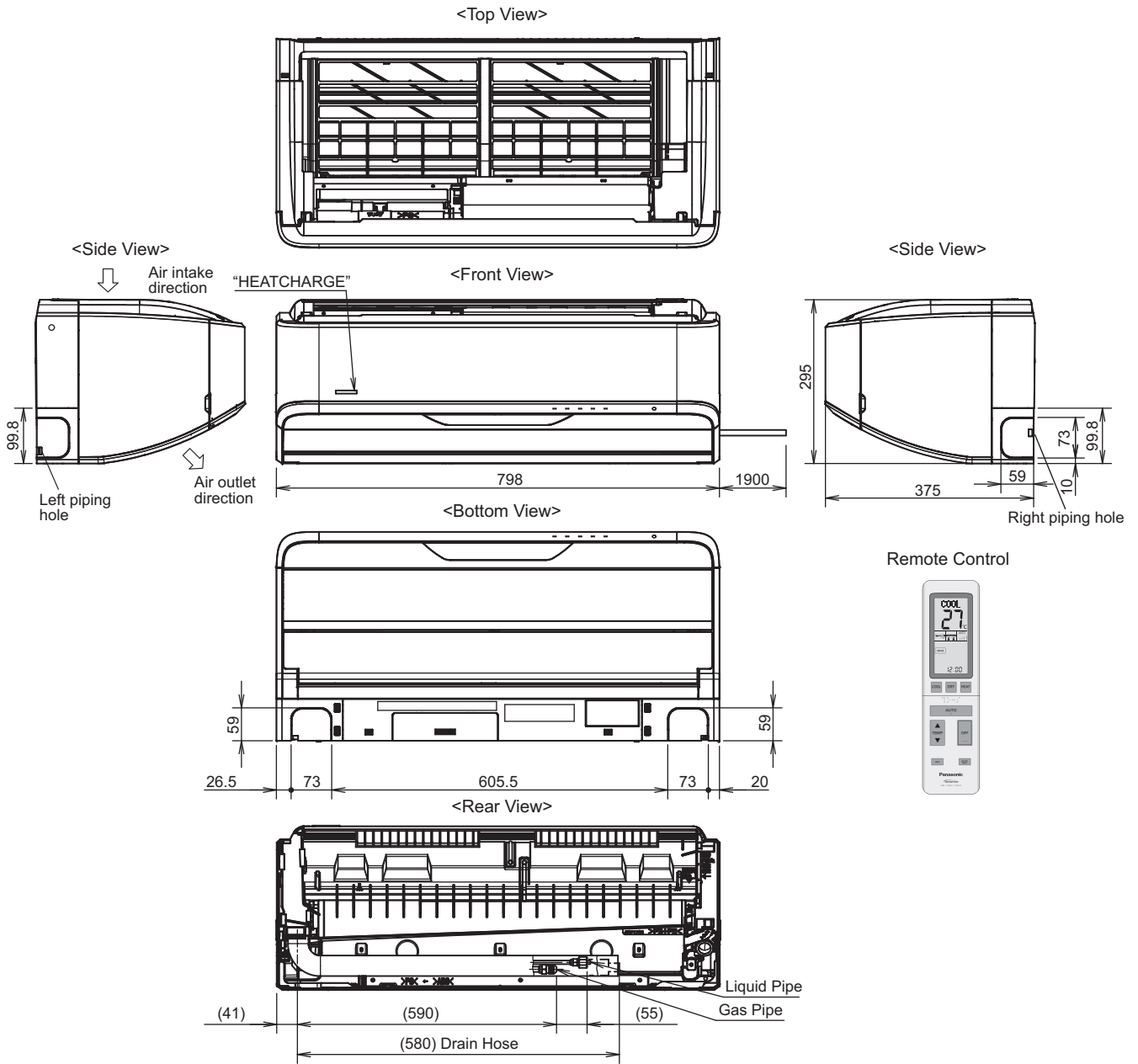

Remote Control



Relative position between the indoor unit and the installation plate

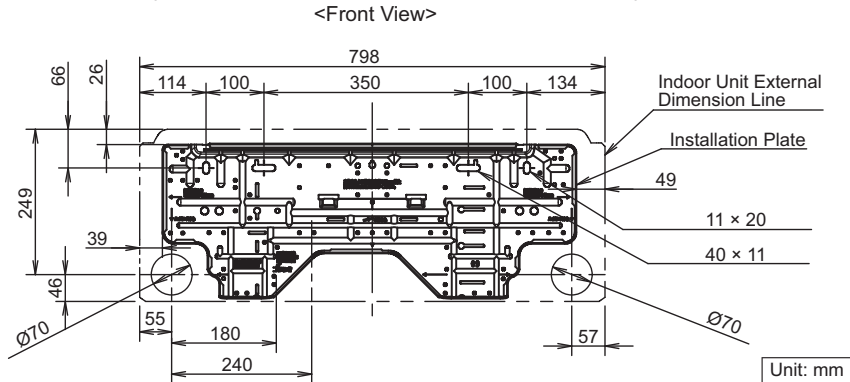

6.2 Outdoor Unit

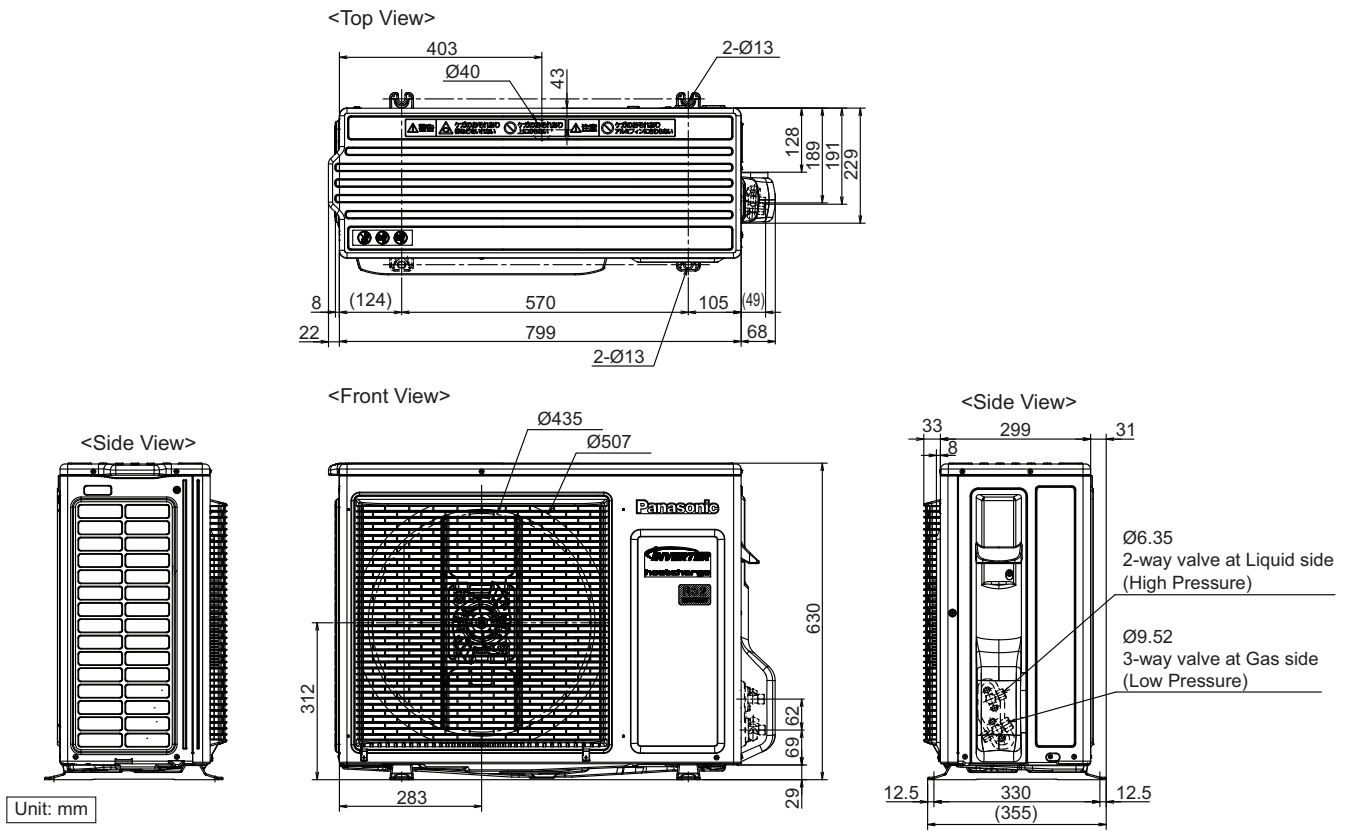

7. Refrigeration Cycle Diagram

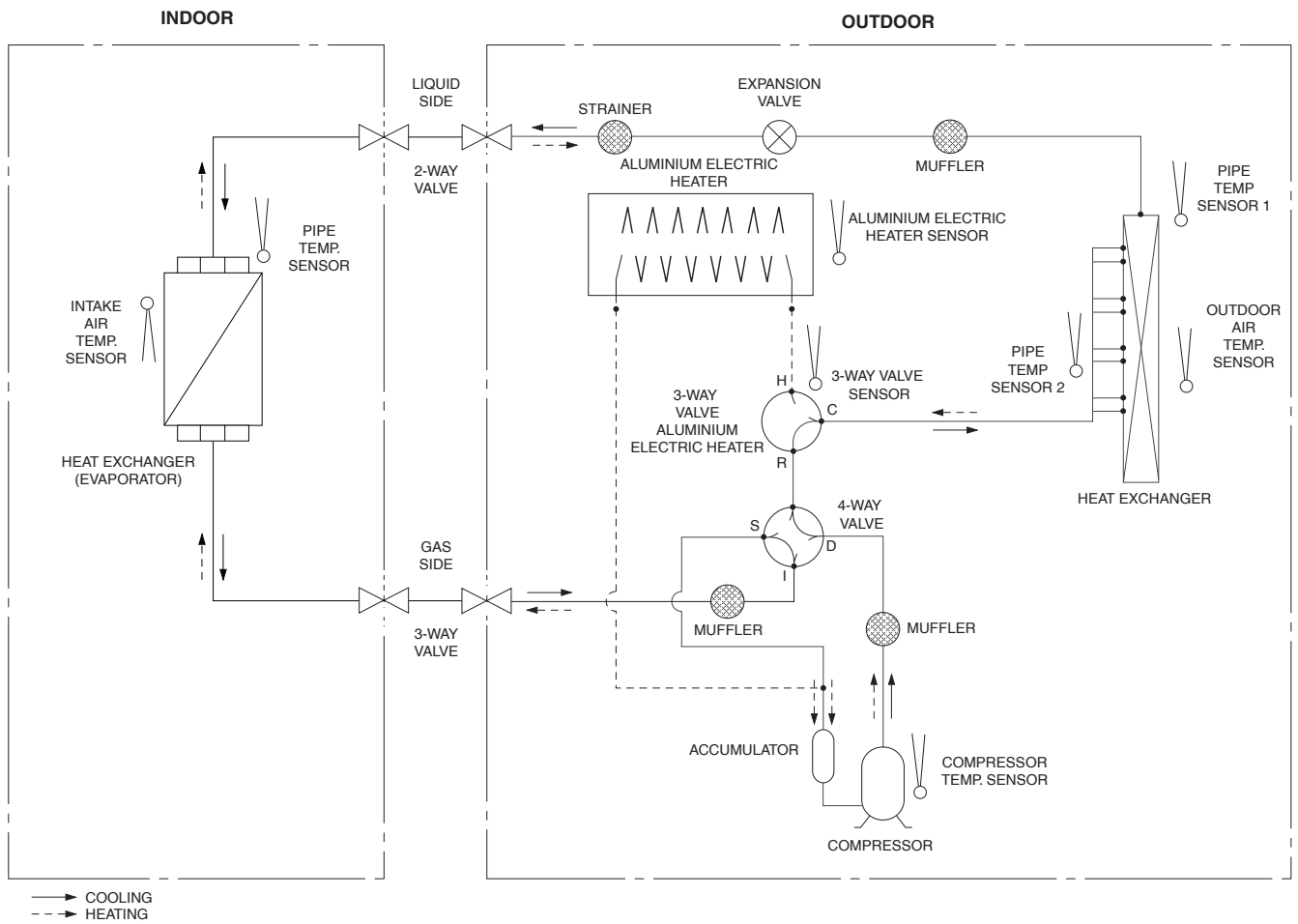

OPERATION MODE	REFRIGERANT FLOW	
	at 4-WAY VALVE REVERSING	at 3-WAY VALVE HEATER
COOLING	D → R I → S	R → C
HEATING	D → I R → S	C → R
NON STOP (HEATING) DEICE	D → I —	C → H
DEICE by REVERSING VALVE	D → R I → S	R → C

7.1 Refrigerant Flow

7.1.1 Heating: 4-WAY VALVE (Reversing Valve) Activate

※ Normal heating operation

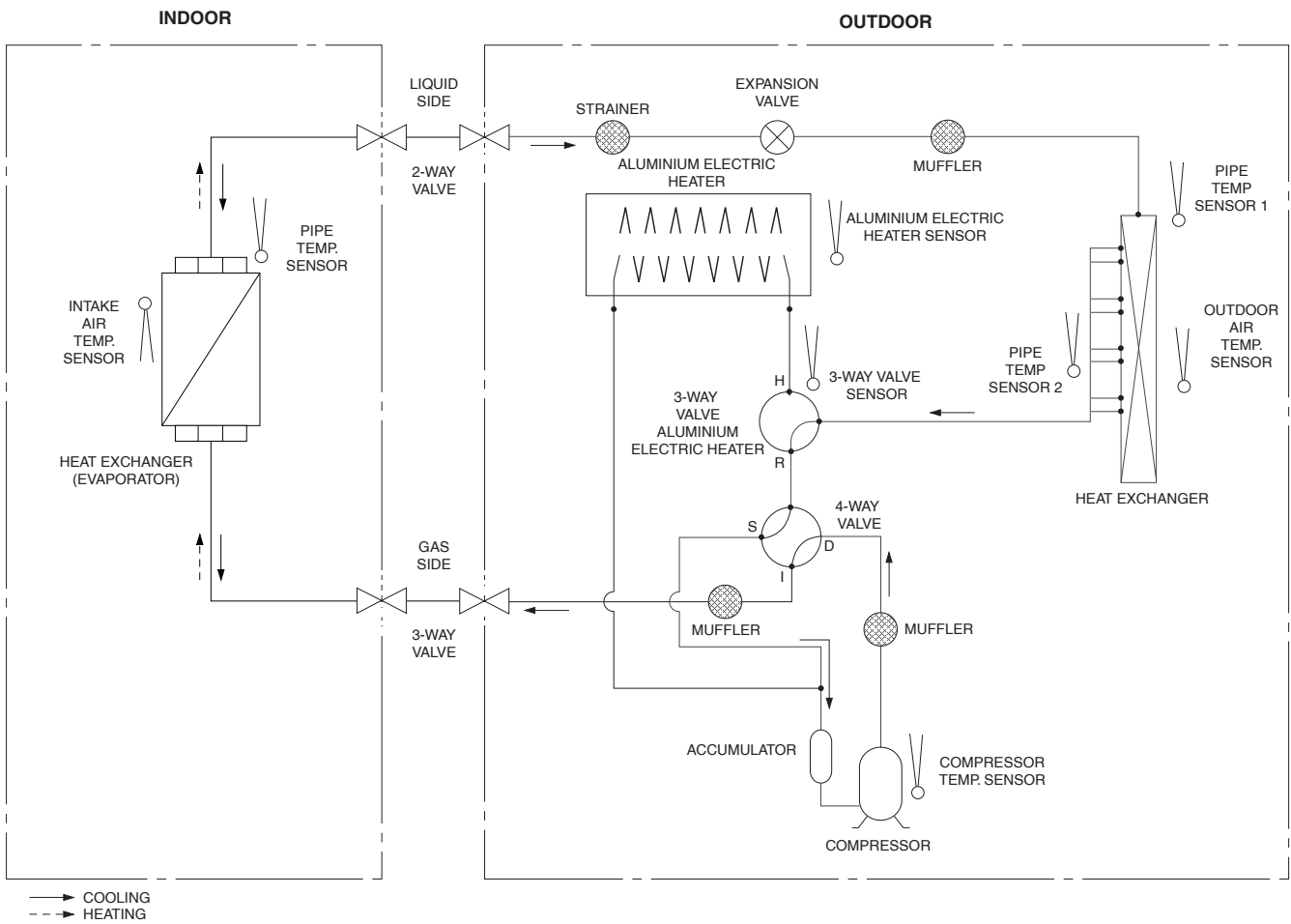

7.2 Deice Operation Flow

7.2.1 Non Stop (Heating) Deice

※ Aluminium Electric Heater Activate

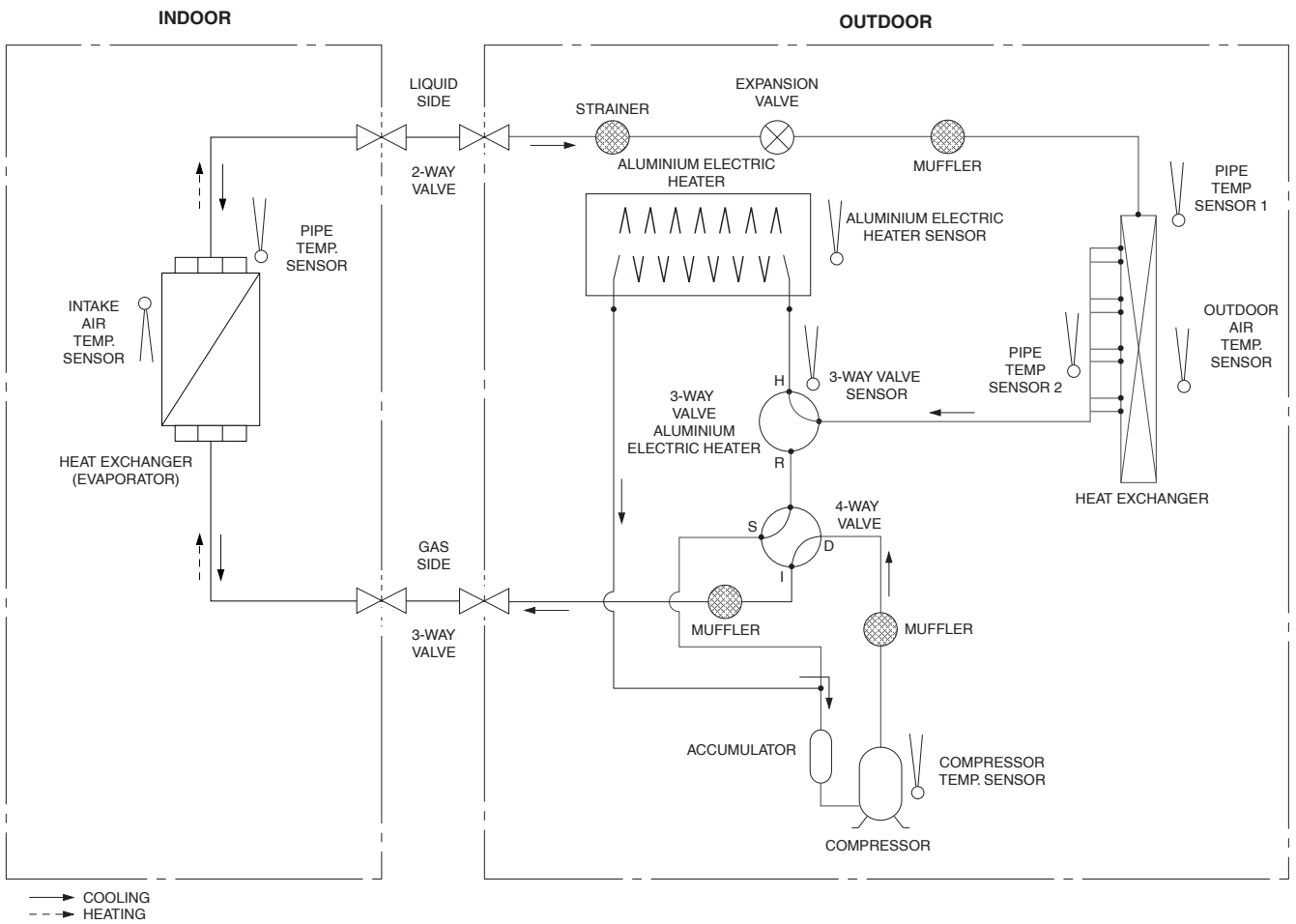

* The Aluminium Electric Heater heats the Refrigerant from Outdoor Heat Exchanger up for continuous operation.

7.2.2 De-icing by 4-Way Valve Activate

※ Cooling Cycle Operation

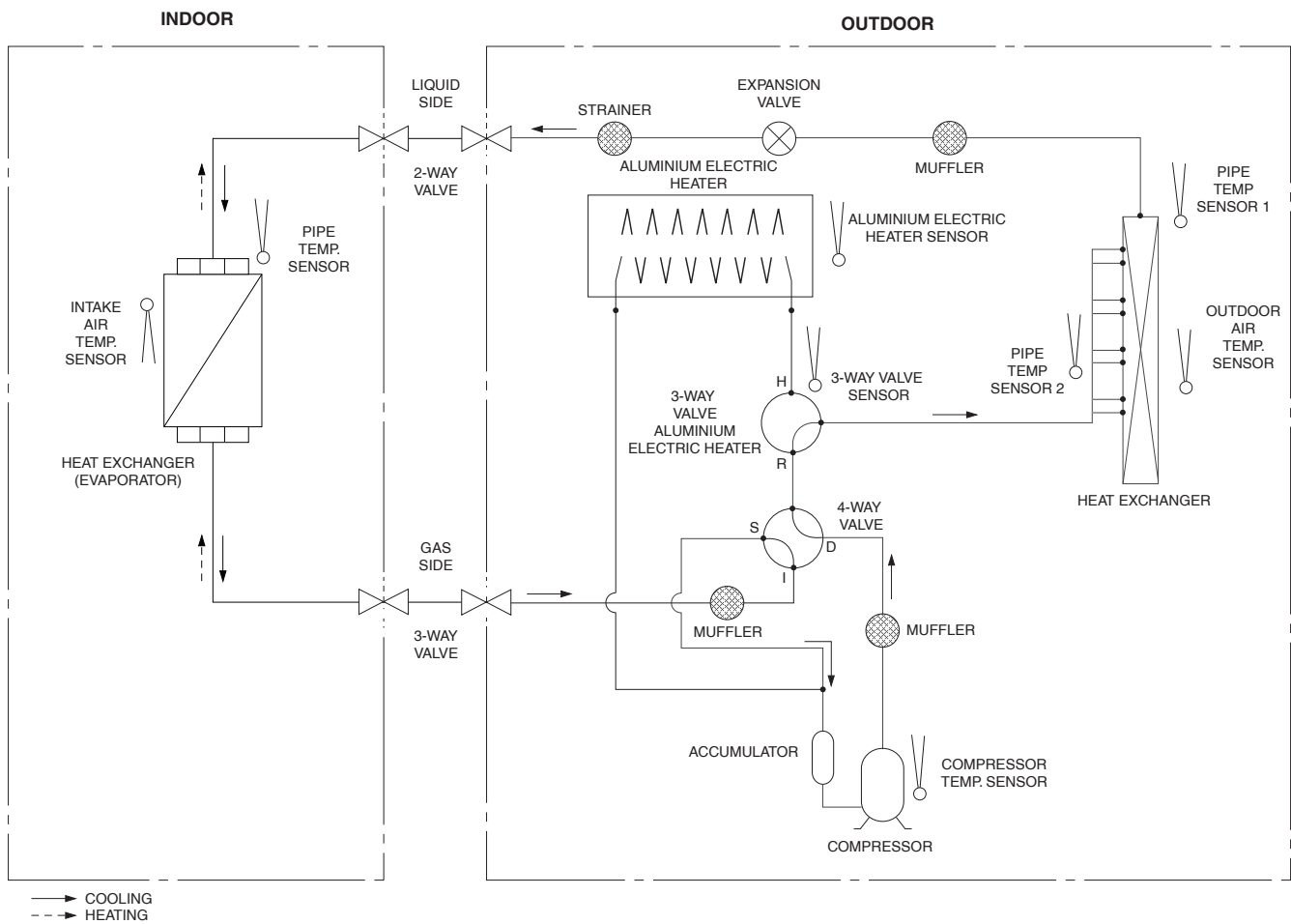

* De-icing will be completed in around 11 minutes or the Pipe Temperature Sensor senses 26°C and above.

7.2.3 Programed Deice Operation at Heating Operation OFF

When the Sensors sense the Outdoor and Pipe Temperature below 0°C, Non Stop (Heating) Deice will be activated automatically.

7.2.4 Forced Deice Operation by Remote-controller

Press (Pre Heating) button for 10 sec, Non Stop (Heating) Deice will be activated manually.
 To stop operation press Stop button.

8. Block Diagram

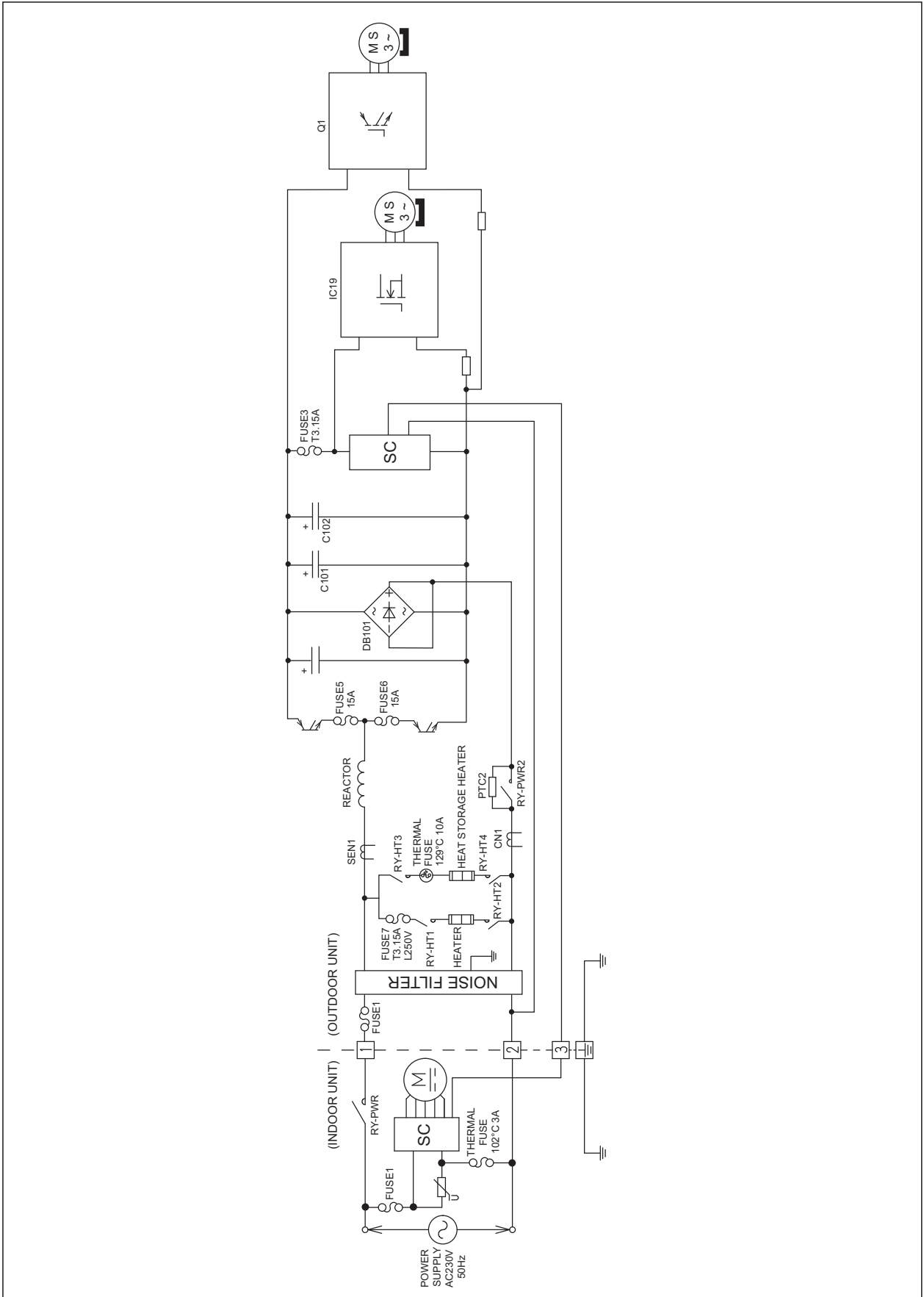

9. Wiring Connection Diagram

9.1 Indoor Unit

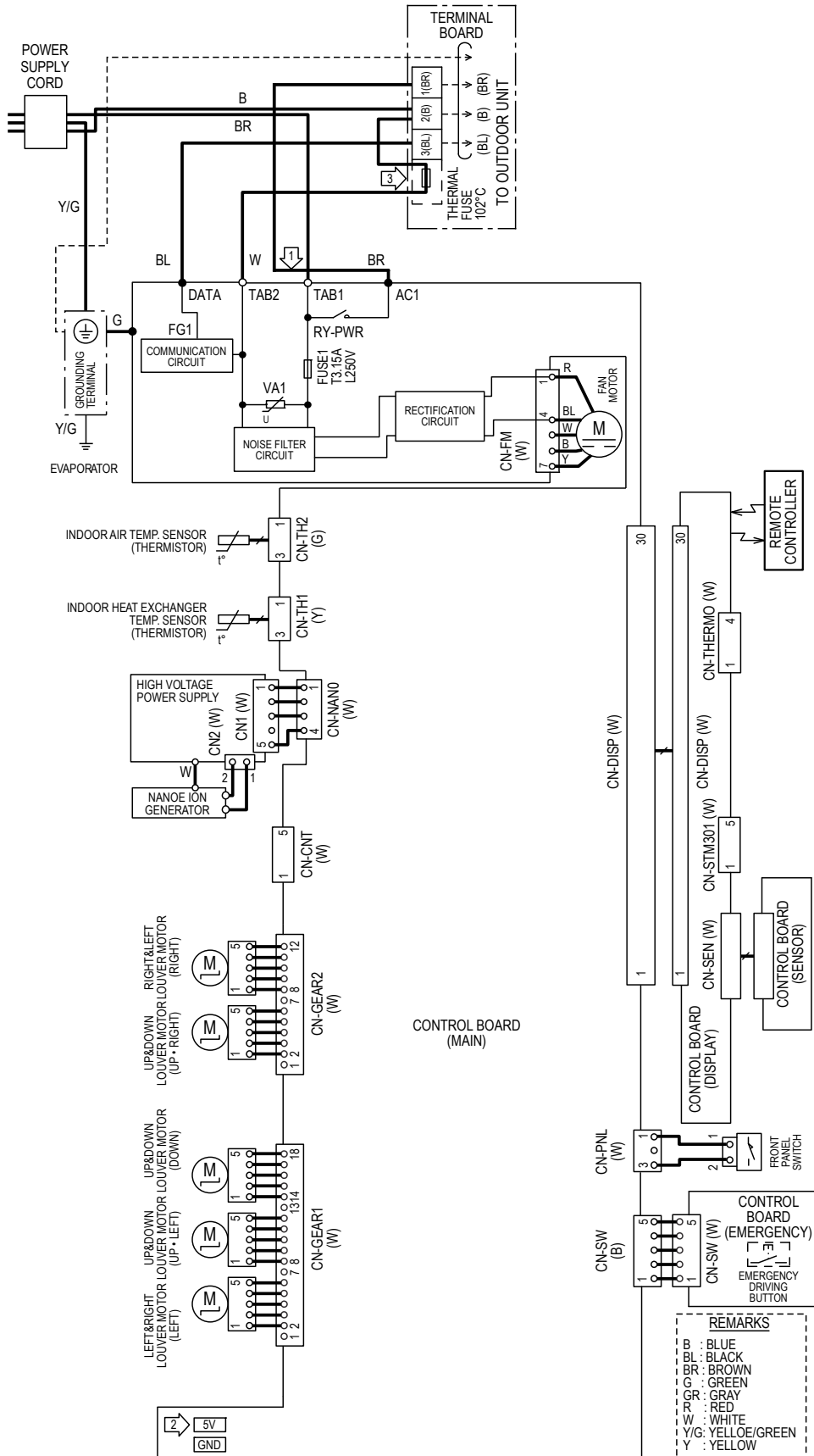

9.2 Outdoor Unit

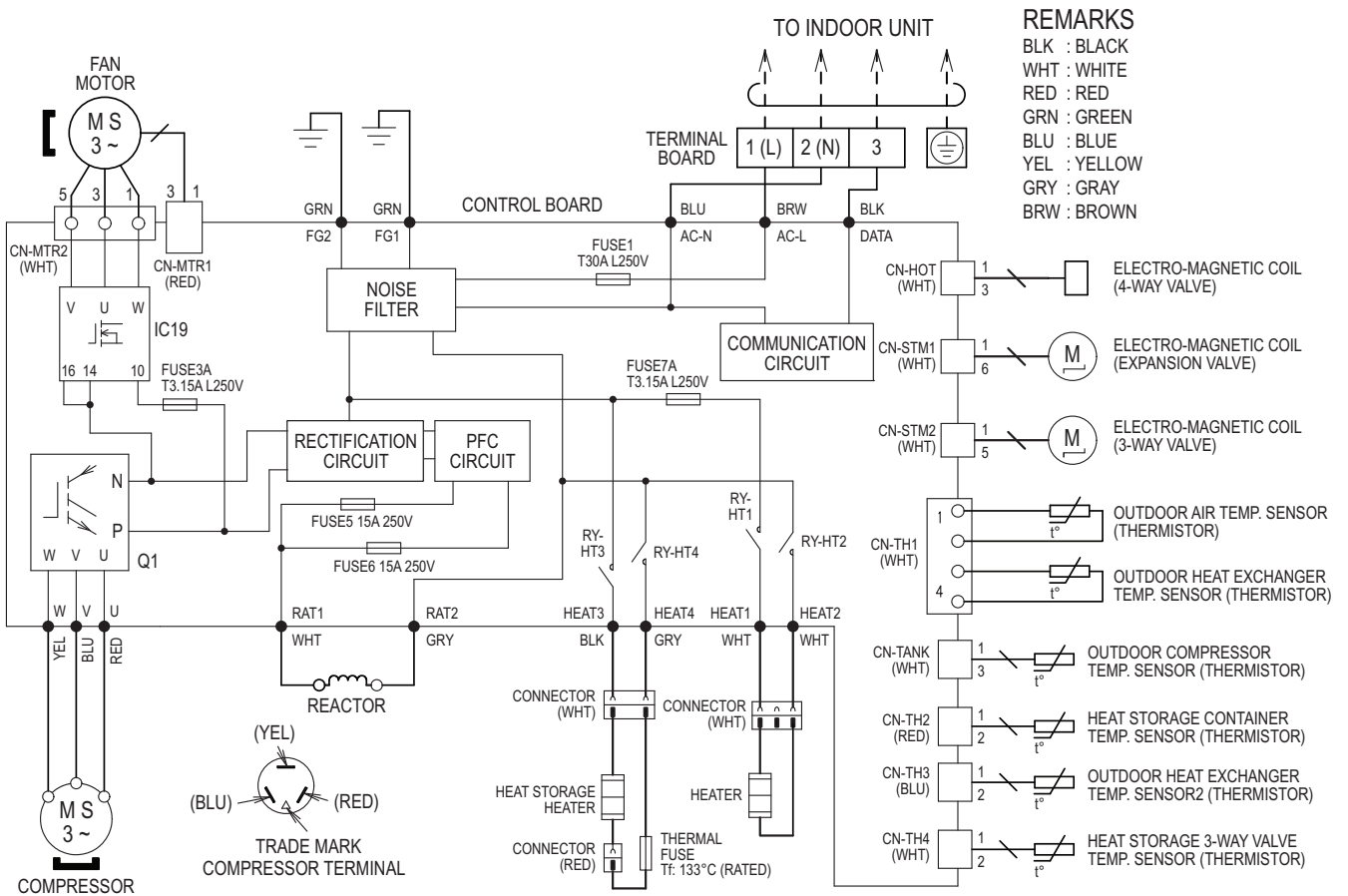

Resistance of Compressor Windings

CONNECTION	9RD138ZAA21
U-V	2.215 Ω
U-W	2.208 Ω
V-W	2.194 Ω

Winding resistance at 20°C.

10. Electronic Circuit Diagram

10.1 Indoor Unit

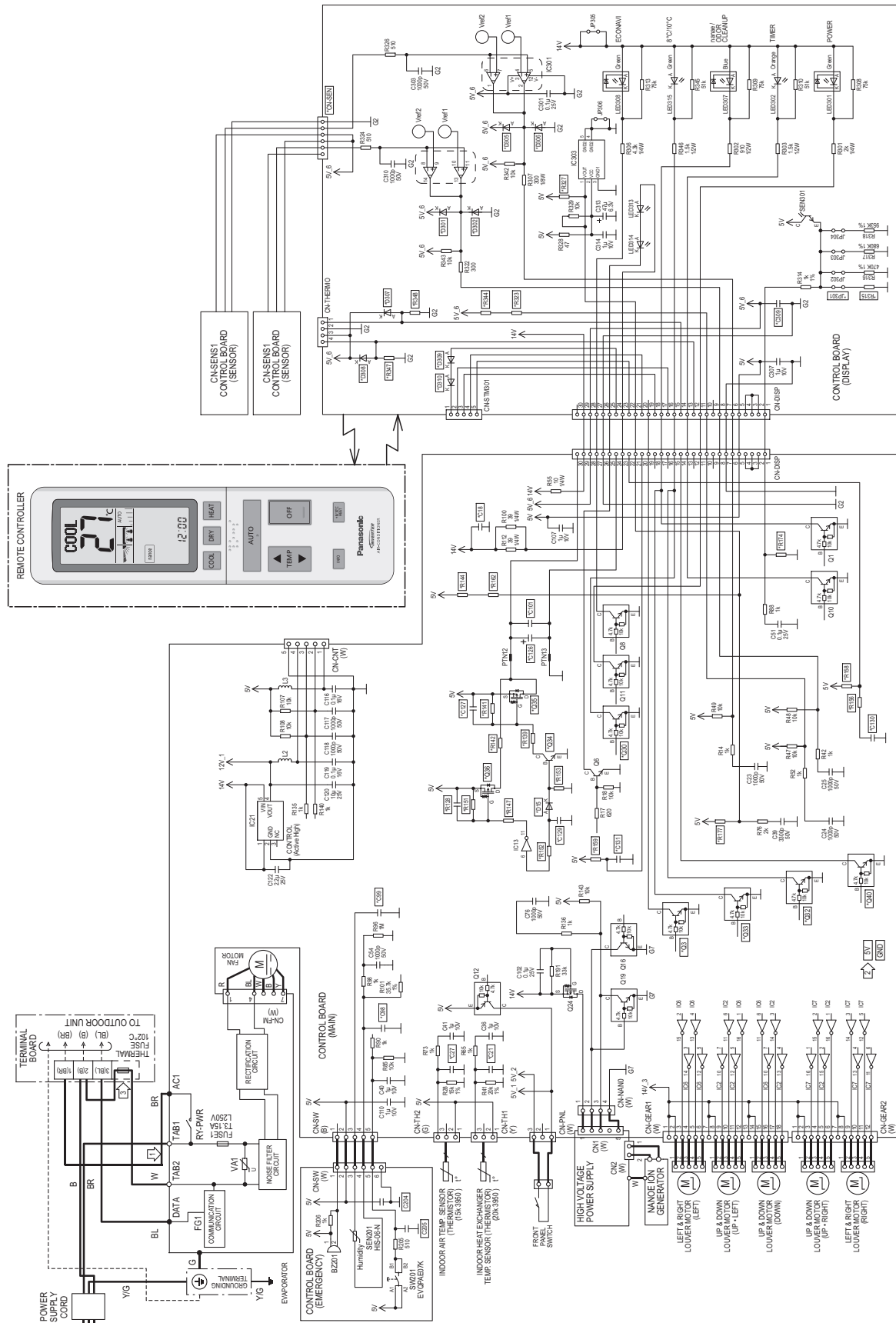

10.2 Outdoor Unit

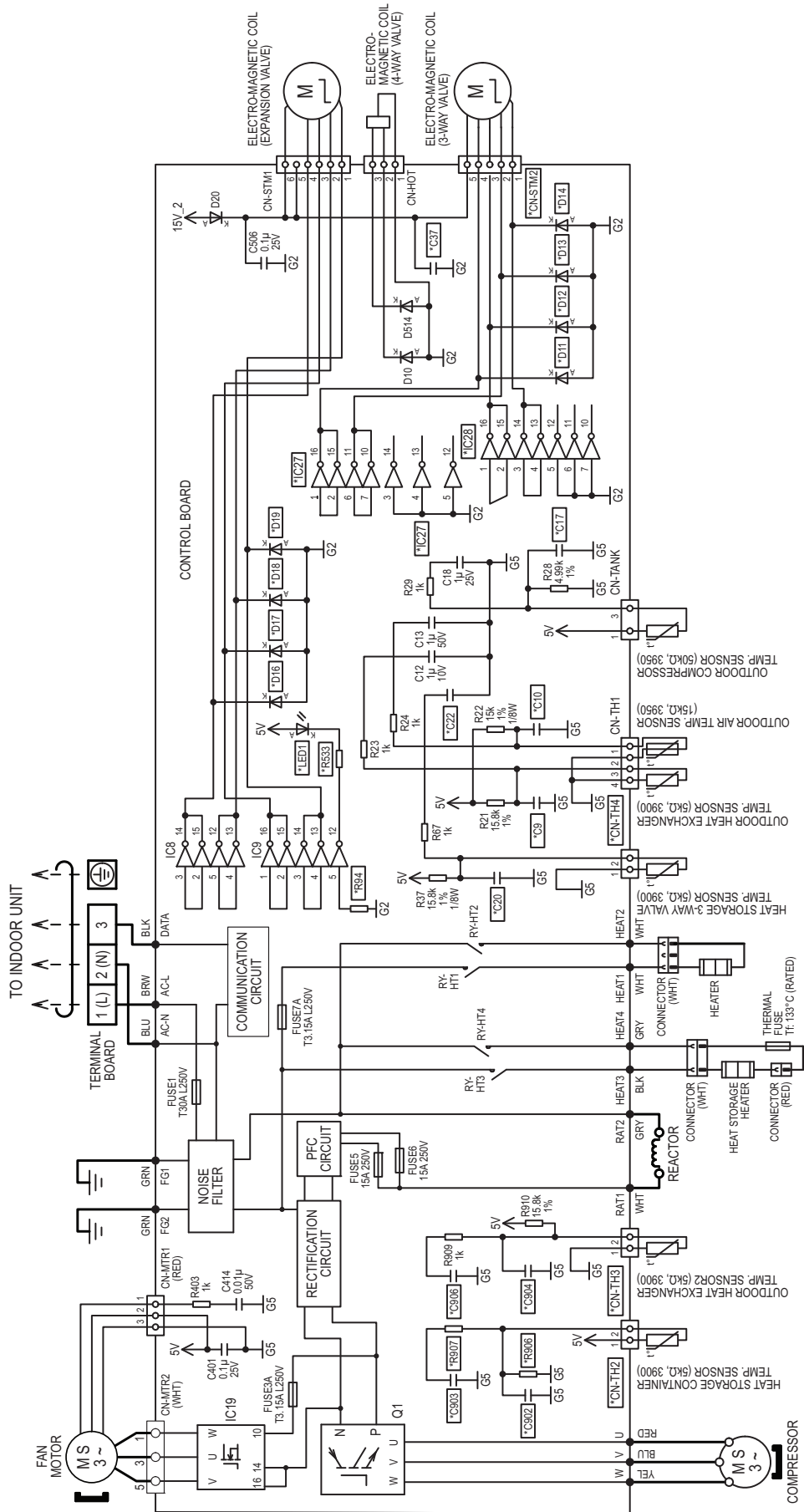

11. Printed Circuit Board

11.1 Indoor Unit

11.1.1 Main Printed Circuit Board

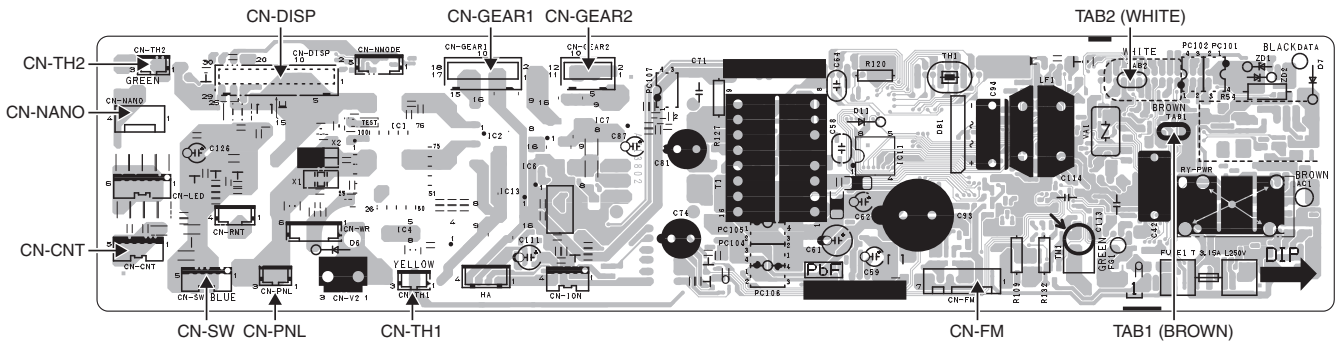

11.1.2 Indicator and Receiver Printed Circuit Board

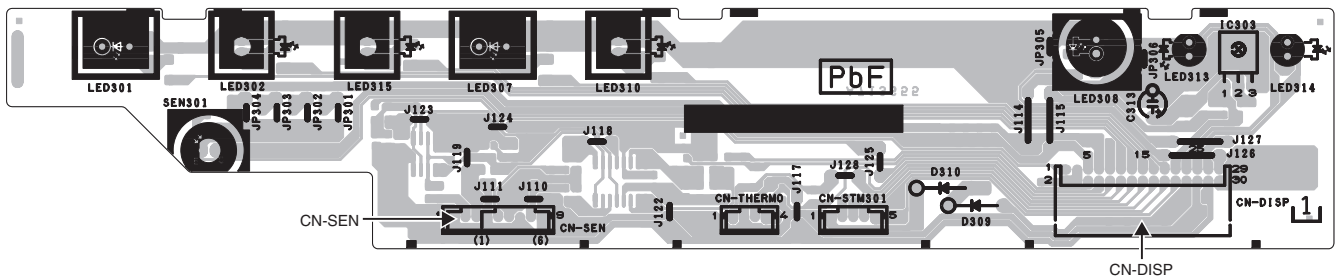

11.1.3 Human Activity Sensor Printed Circuit Board

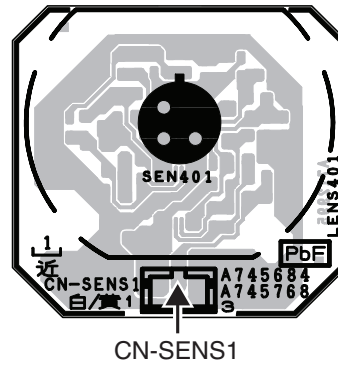

11.1.4 nanoe Printed Circuit Board

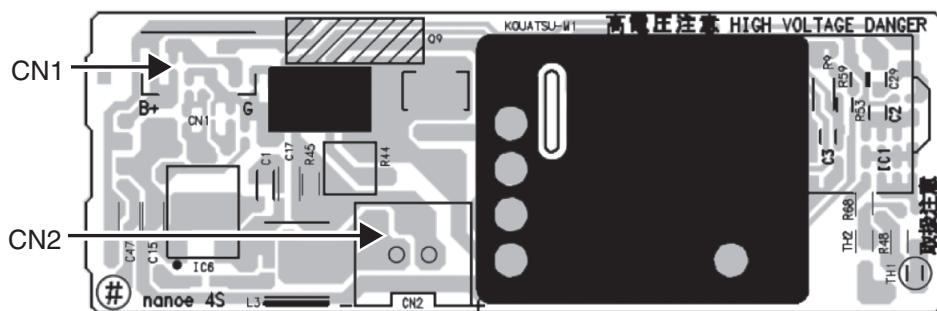

11.1.5 Emergency Switch Printed Circuit Board

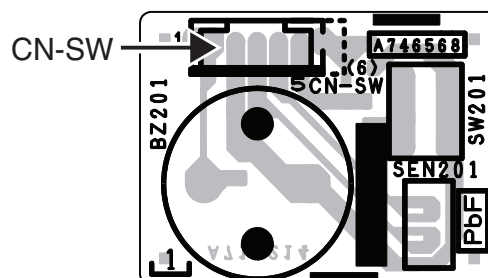

12. Installation Instruction

12.1 Select The Best Location

12.1.1 Indoor Unit

- Do not install the unit in excessive oil fume area such as kitchen, workshop and etc.
- There should not be any heat source or steam near the unit.
- There should not be any obstacles blocking the air circulation.
- A place where air circulation in the room is good.
- A place where drainage can be easily done.
- A place where noise prevention is taken into consideration.
- Do not install the unit near the door way.
- Ensure the spaces indicated by arrows from the wall, ceiling, fence or other obstacles.
- Recommended installation height for indoor unit shall be at least 2.5 m.

12.1.2 Outdoor Unit

- If an awning is built over the unit to prevent direct sunlight or rain, be careful that heat radiation from the condenser is not obstructed.
- There should not be any animal or plant which could be affected by hot air discharged.
- Keep the spaces indicated by arrows from wall, ceiling, fence or other obstacles.
- Do not place any obstacles which may cause a short circuit of the discharged air.
- If piping length is over the [piping length for additional gas], additional refrigerant should be added as shown in the table.

Model	Horse Power (HP)	Piping size		Std. Length (m)	Max. Elevation (m)	Min. Piping Length (m)	Max. Piping Length (m)	Additional Refrigerant (g/m)	Piping Length for add. gas (m)
		Gas	Liquid						
VZ9***	1.0HP	9.52 mm (3/8")	6.35 mm (1/4")	5	12	3	15	20	7.5
VZ12***	1.5HP								

Example: For VZ9***

If the unit is installed at 12 m distance, the quantity of additional refrigerant should be 40 g $(12-10) \text{ m} \times 20 \text{ g/m} = 40 \text{ g}$.

12.1.3 Indoor/Outdoor Unit Installation Diagram

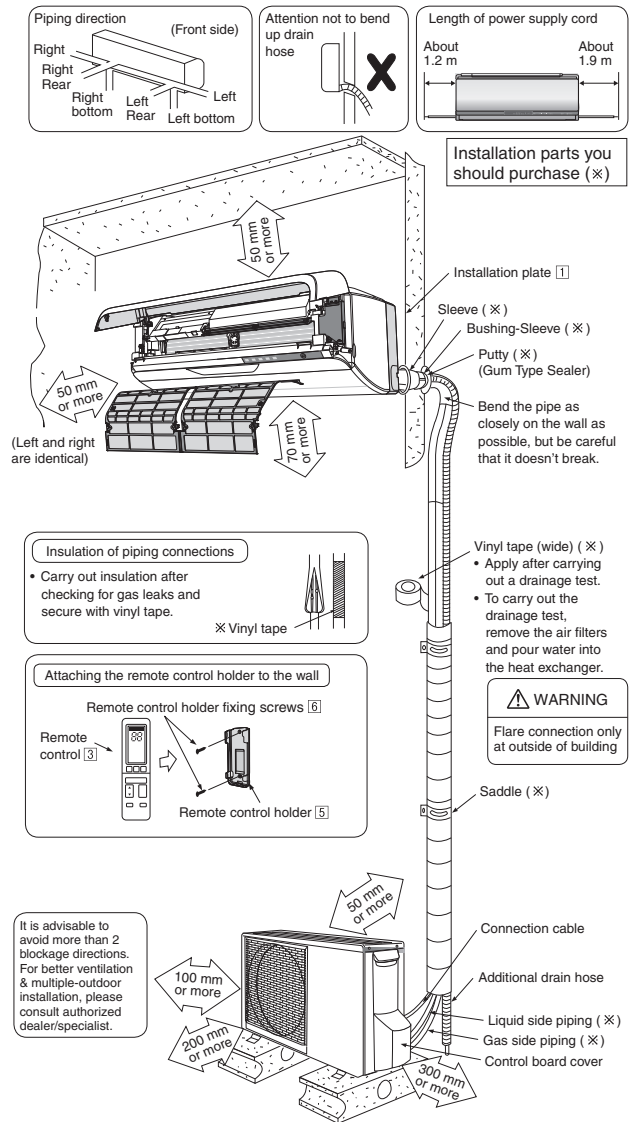

This illustration is for explanation purposes only. The indoor unit will actually face a different way.

12.2 Indoor Unit

12.2.1 How to Fix Installation Plate

The mounting wall shall be strong and solid enough to prevent it from vibration.

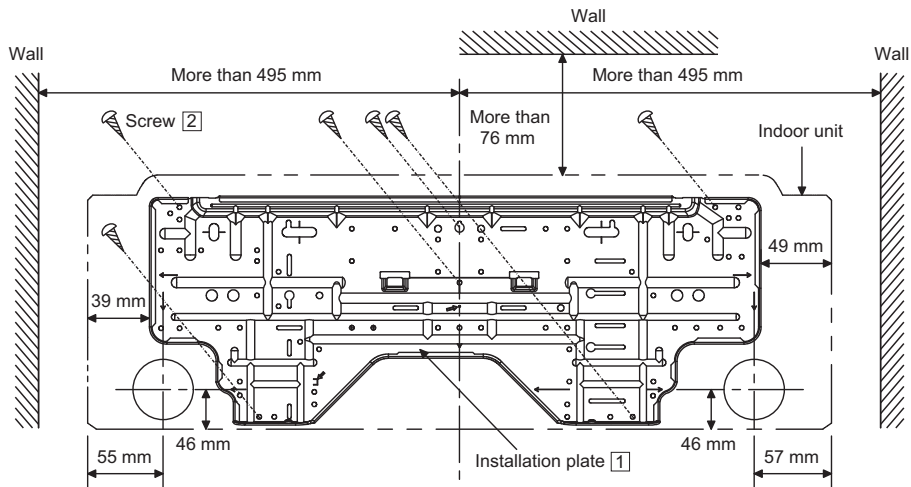

The center of the installation plate should be at more than 495 mm at right and left of the wall.

The distance from installation plate edge to ceiling should more than 76 mm.

From installation plate left edge to unit's left side is 39 mm.

From installation plate right edge to unit's right side is 49 mm.

1. Mount the installation plate on the wall with 6 screws or more (at least 6 screws).
(If mounting the unit on the concrete wall, consider using anchor bolts.)
 - Always mount the installation plate horizontally by aligning the marking-off line with the thread and using a level gauge.
2. Drill the piping plate hole with $\varnothing 70$ mm hole-core drill.
 - The hole center of the pipe is the meeting point of the following two lines, the vertically extended line of the down arrow on the plate and the horizontally extended line of the side arrow on the plate. (see figure above).
 - Drill the piping hole at either the right or the left and the hole should be slightly slanted to the outdoor side.

12.2.2 To Drill a Hole in the Wall and Install a Sleeve of Piping

- 1 Insert the piping sleeve to the hole.
- 2 Fix the bushing to the sleeve.
- 3 Cut the sleeve until it extrudes about 15 mm from the wall.

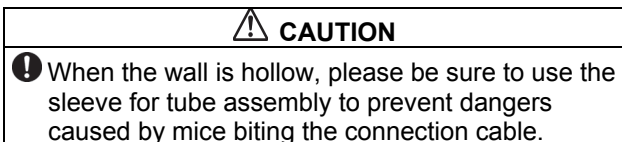

- 4 Finish by sealing the sleeve with putty or caulking compound at the final stage.

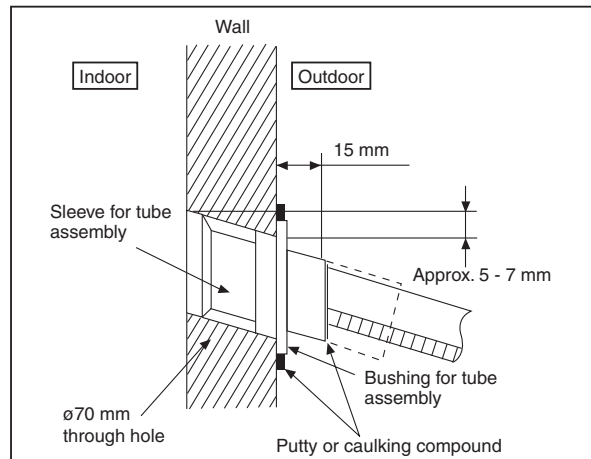

12.2.3 Indoor Unit Installation

- Do not turn over the unit without its shock absorber during pull out the piping. It may cause intake grille damage.
- Use shock absorber during pull out the piping to protect the intake grille from damage.

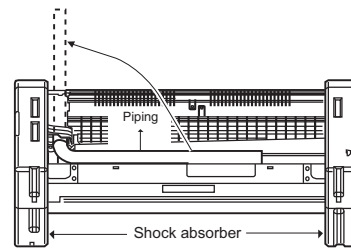
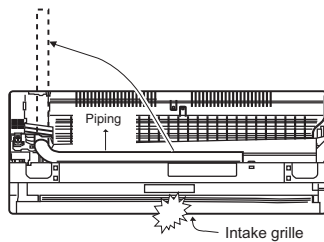

12.2.3.1 For the right rear piping

- Step-1** Pull out the Indoor piping
- Step-2** Install the Indoor Unit
- Step-3** Secure the Indoor Unit
- Step-4** Insert the connection cable

12.2.3.2 For the right and right bottom piping

- Step-1** Pull out the Indoor piping
- Step-2** Install the Indoor Unit
- Step-3** Insert the connection cable
- Step-4** Secure the Indoor Unit

12.2.3.3 For the embedded piping

- Step-1** Replace the drain hose
- Step-2** Bend the embedded piping
 - Use a spring bender or equivalent to bend the piping so that the piping is not crushed.
- Step-3** Pull the connection cable into Indoor Unit
 - The inside and outside connection cable can be connected without removing the front grille.
- Step-4** Cut and flare the embedded piping
 - When determining the dimensions of the piping, slide the unit all the way to the left on the installation plate.
 - Refer to the section "Cutting and flaring the piping".
- Step-5** Install the Indoor Unit
- Step-6** Connect the piping
 - Please refer to "Connecting the piping" column in outdoor unit section. (Below steps are done after connecting the outdoor piping and gas-leakage confirmation).
- Step-7** Insulate and finish the piping
 - Please refer to "Insulation of piping connection" column as mentioned in indoor/outdoor unit installation.
- Step-8** Secure the Indoor Unit

Right Rear piping

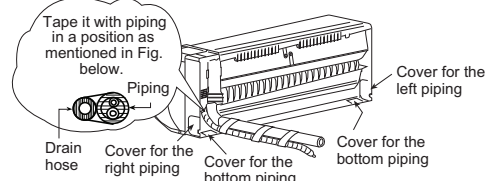

How to keep the cover

In case of the cover is cut, keep the cover at the rear of chassis as shown in the illustration for future reinstallation. (Left, right and 2 bottom covers for piping.)

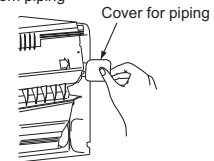

Right and Right Bottom piping

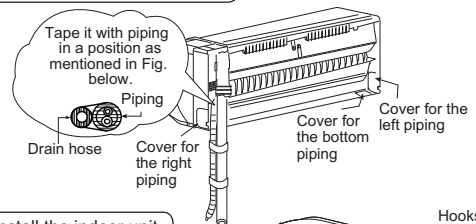

Install the indoor unit

Hook the indoor unit onto the upper portion of installation plate. (Engage the indoor unit with the upper edge of the installation plate). Ensure the hooks are properly seated on the installation plate by moving it in left and right.

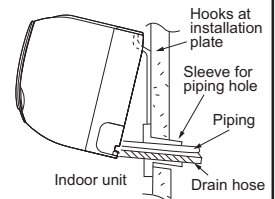

Secure the Indoor Unit

1. Press the lower left and right side of the unit against the installation plate until hooks engages with their slot (sound click).

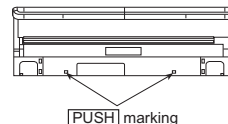
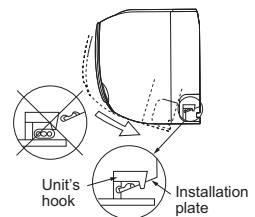

To take out the unit, push the [PUSH] marking at the bottom unit, and pull it slightly towards you to disengage the hooks from the unit.

Insert the connection cable

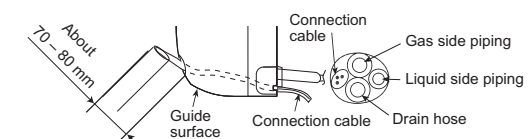

(This can be used for left rear piping and bottom piping also.)

Exchange the drain hose and the cap

Rear view for left piping installation

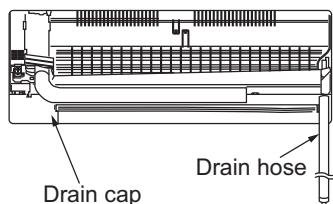

When inserting a drain cap into the unit, do not use a lubricant (such as refrigerating oil.) This may cause damage and water leakage.

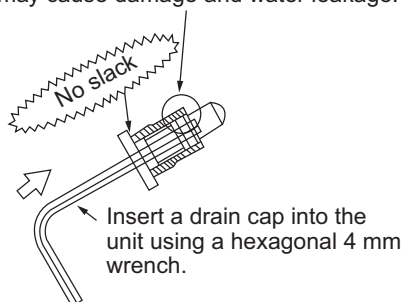

- In case of left piping how to insert the connection cable and drain hose.

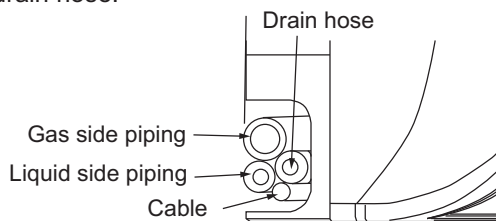

(For the right piping, follow the same procedure)

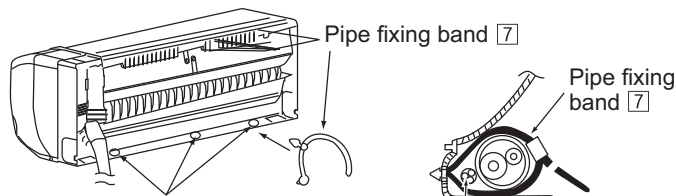

In case of left, rear left or lower left tubing, any hole can be used.

Connection cable

Cut off the excess hose clamp. (Otherwise, it may cause abnormal noise or water leakage.)

- How to pull the piping and drain hose out, in case of the embedded piping.

Apply putty or caulking material to seal the wall opening.

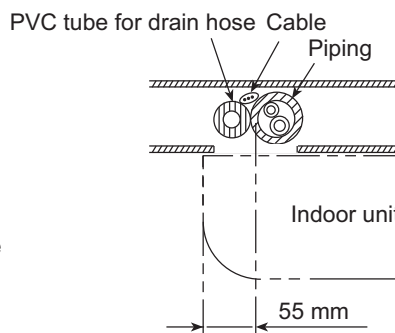
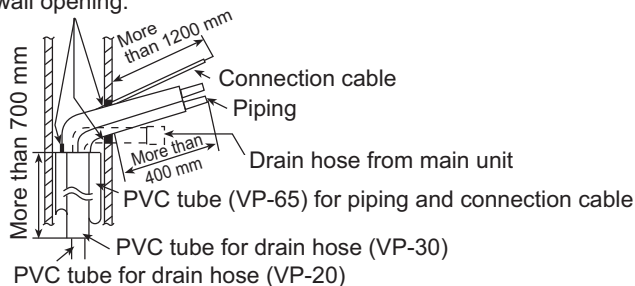

12.2.4 Connect the Cable to the Indoor Unit

1. The inside and outside connection cable can be connected without removing the front grille.
2. **Connection cable** between indoor unit and outdoor unit shall be approved polychloroprene sheathed $4 \times 1.5 \text{ mm}^2$ flexible cord, type designation 245 IEC 57 or heavier cord.
3. Bind all the indoor and outdoor connection cable with tape and route the connection cable via the escapement.
4. Remove the tapes and connect the connection cable between indoor unit and outdoor unit according to the diagram below.

Terminals on the indoor unit	1	2	3	
Colour of wires				
Terminals on the outdoor unit	1	2	3	

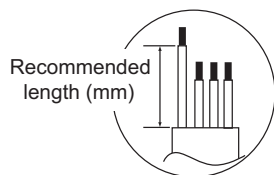

Recommended length (mm)	a	b	c	d
	30	30	30	50

WARNING

This equipment must be properly earthed.

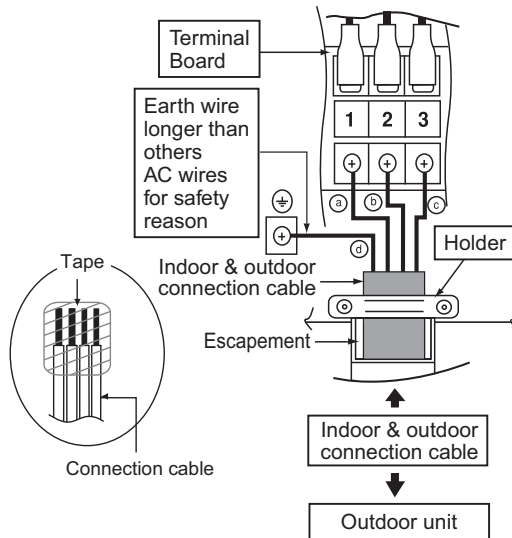

Note:

- Secure the connection cable onto the control board with the holder (clamper).
- Ensure the colour of wires of outdoor unit and the terminal Nos. are the same to the indoor's respectively.
- Earth wire shall be Yellow/Green (Y/G) in colour and longer than other AC wires for safety reason.

12.2.4.1 Wire Stripping and Connecting Requirement

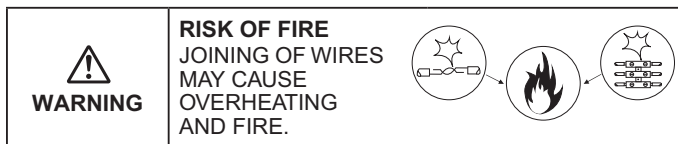
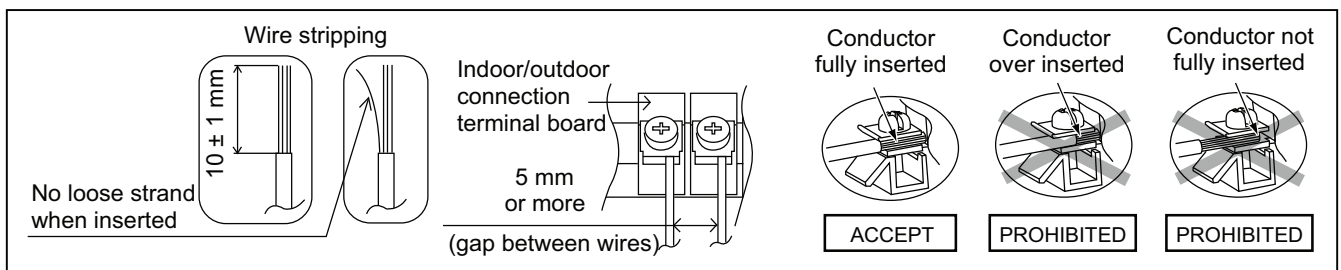

- Do not joint wires

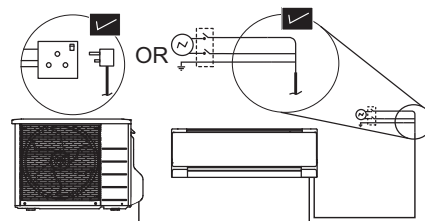
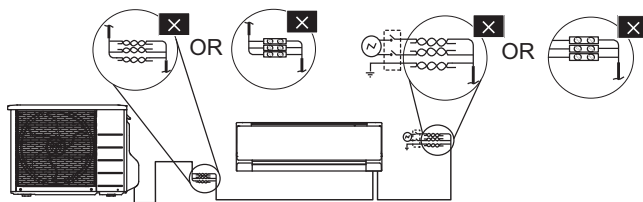

- Use complete wire without joining.
- Use approved socket and plug with earth pin.
- Wire connection in this area must follow to national wiring rules.

12.2.4.2 Cutting and flaring the piping

- 1 Please cut using pipe cutter and then remove the burrs.
- 2 Remove the burrs by using reamer. If burrs is not removed, gas leakage may be caused. Turn the piping end down to avoid the metal powder entering the pipe.
- 3 Please make flare after inserting the flare nut onto the copper pipes.

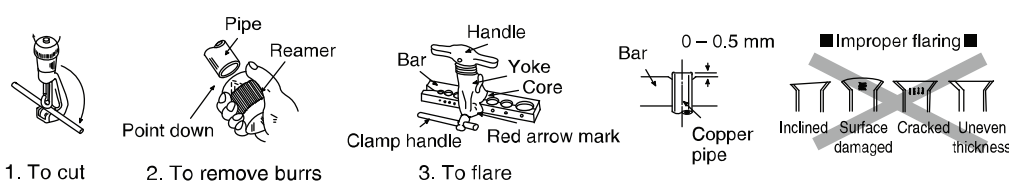

When properly flared, the internal surface of the flare will evenly shine and be of even thickness. Since the flare part comes into contact with the connections, carefully check the flare finish.

12.3 Outdoor Unit

12.3.1 Install the Outdoor Unit

- After selecting the best location, start installation to Indoor/Outdoor Unit Installation Diagram.
 - Install at least 3 cm above the ground. Do not install the unit on the floor.
 - Fix the unit on concrete or rigid frame firmly and horizontally by bolt nut ($\phi 10$ mm). Install the outdoor unit in a level position and do not block the holes. Failure to do so may result in water leakage or accumulation.
 - When installing at roof, please consider strong wind and earthquake. Please fasten the installation stand firmly with bolt or nails.

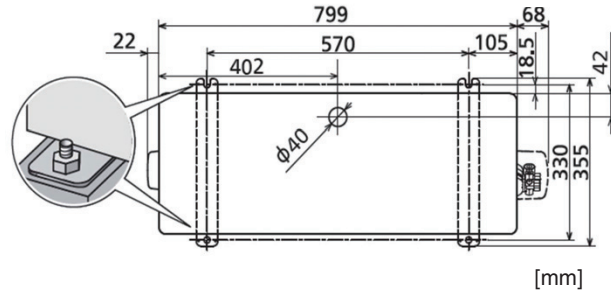

12.3.2 Connect the piping

12.3.2.1 Connecting the piping to Indoor Unit

For connection joint location at outside building

Please make flare after inserting flare nut (locate at joint portion of tube assembly) onto the copper pipe. (In case of using long piping)

Connect the piping

- Align the center of piping and sufficiently tighten the flare nut with fingers.
- Further tighten the flare nut with torque wrench in specified torque as stated in the table.

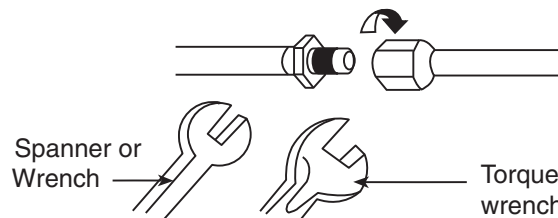

For connection joint location at inside building

- Decide the length.
- Cut and remove the tube connectors at indoor copper pipings (both gas and liquid piping) by using pipe cutter. Remove burrs from cut edge.
- Use pipe expander to expand the end of long piping.
- Align the center of piping and braze the piping joints.

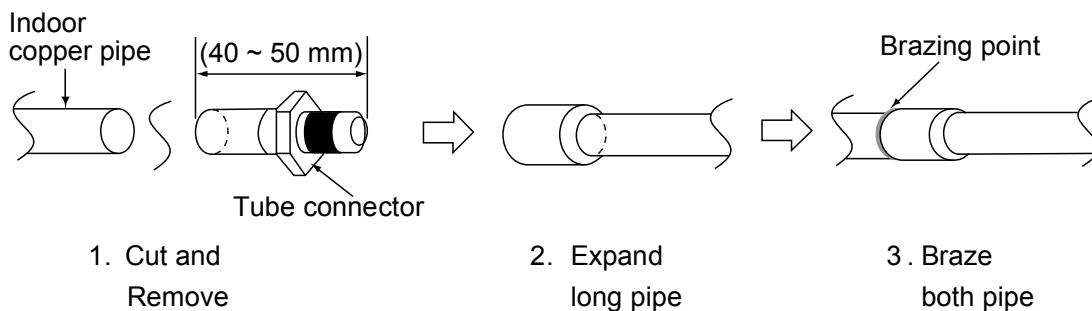

12.3.2.2 Connecting the piping to Outdoor Unit

Decide piping length and then cut by using pipe cutter.
Remove burrs from cut edge.
Make flare after inserting the flare nut (locate at valve) onto the copper pipe.
Align center of piping to valve and then tighten with torque wrench to the specified torque as stated in the table.

Do not overtighten, overtightening may cause gas leakage.	
Piping size	Torque
6.35 mm (1/4")	[18 N•m (1.8 kgf•m)]
9.52 mm (3/8")	[42 N•m (4.3 kgf•m)]
12.7 mm (1/2")	[55 N•m (5.6 kgf•m)]
15.88 mm (5/8")	[65 N•m (6.6 kgf•m)]
19.05 mm (3/4")	[100 N•m (10.2 kgf•m)]

12.3.3 Evacuation of the Equipment

WHEN INSTALLING AN AIR CONDITIONER, BE SURE TO EVACUATE THE AIR INSIDE THE INDOOR UNIT AND PIPES in the following procedure.

- ⊘ Do not purge the air with refrigerants but use a vacuum pump to vacuum the installation.
- ⚠ There is no extra refrigerant in the outdoor unit for air purging.

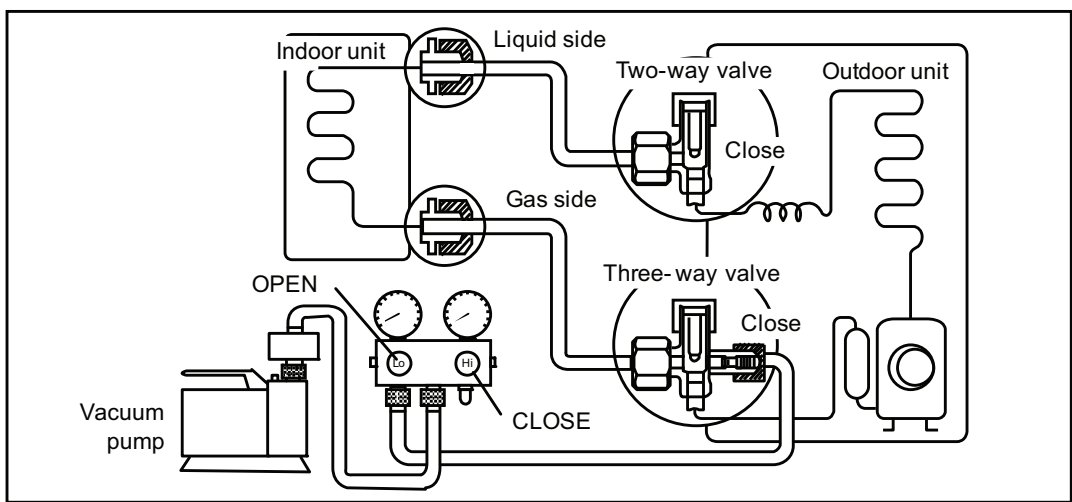







- 1 Connect a charging hose with a push pin to the Low side of a charging set and the service port of the 3-way valve.
 - Be sure to connect the end of the charging hose with the push pin to the service port.
- 2 Connect the center hose of the charging set to a vacuum pump.
- 3 Turn on the power switch of the vacuum pump and make sure that the needle in the gauge moves from 0 cmHg (0 MPa) to -76 cmHg (-0.1 MPa). Then evacuate the air approximately ten minutes.
- 4 Close the Low side valve of the charging set and turn off the vacuum pump. Make sure that the needle in the gauge does not move after approximately five minutes.

Note : BE SURE TO TAKE THIS PROCEDURE IN ORDER TO AVOID REFRIGERANT GAS LEAKAGE.
- 5 Disconnect the charging hose from the vacuum pump and from the service port of the 3-way valve.
- 6 Tighten the service port caps of the 3-way valve at a torque of 18 N•m with a torque wrench.
- 7 Remove the valve caps of both of the 2-way valve and 3-way valve. Position both of the valves to "OPEN" using a hexagonal wrench (4 mm).
- 8 Mount valve caps onto the 2-way valve and the 3-way valve.
 - Be sure to check for gas leakage.

1. If gauge needle does not move from 0 cmHg (0 MPa) to -76 cmHg (-0.1 MPa), in the step ③ above take the following measure:
 - If the leak stops when the piping connections are tightened further, continue working from step ③.
 - If the leak does not stop when the connections are retightened, repair location of leak.
 - Do not release refrigerant during piping work for installation and reinstallation.
 - Take care of the liquid refrigerant, it may cause frostbite.

12.3.4 Connect the cable to the Outdoor Unit

1. Remove the control board cover from the unit by loosening the screw.
2. **Connection cable** between indoor unit and outdoor unit shall be approved polychloroprene sheathed 4×1.5 mm² flexible cord, type designation 245 IEC 57 or heavier cord.
3. Connect the connection cable between indoor unit and outdoor unit according to the diagram below.

Terminals on the indoor unit	1	2	3	
Colour of wires				
Terminals on the outdoor unit	1	2	3	

4. Secure the connection cable onto the control board with the holder.
5. Attach the control board cover back to the original position with screw.
6. For wire stripping and connection requirement, refer to instruction 12.2.4 of indoor unit.

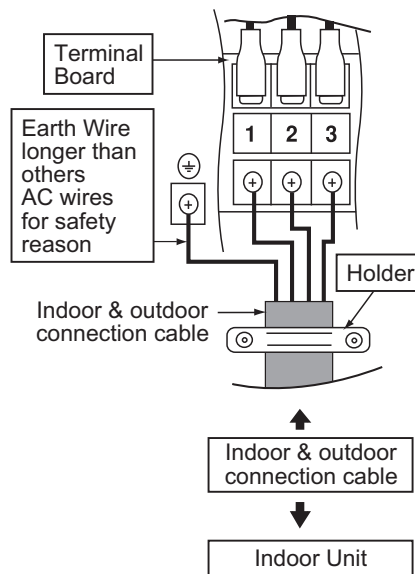

 WARNING
 This equipment must be properly earthed.

Note:

- Isolating Devices (Disconnecting means) should have minimum 3.0 mm contact gap.
- Earth wire shall be Yellow/Green (Y/G) in colour and longer than other AC wires for safety reason.

12.3.5 Piping Insulation

1. Please carry out insulation at pipe connection portion as mentioned in Indoor/Outdoor Unit Installation Diagram. Please wrap the insulated piping end to prevent water from going inside the piping.
2. If drain hose or connecting piping is in the room (where dew may form), please increase the insulation by using POLY-E FOAM with thickness 6 mm or above.

13. Installation and Servicing Air Conditioner using R32

13.1 About R32 Refrigerant

For air conditioning refrigerants such as R410A, the refrigerants were collected back in order to prevent their air dissipation, to curbe the global warming impact, in case they were released into the atmosphere. In the “4th Environmental Basic Plan”, 80% reduction of greenhouse gas emissions by 2050 is required, and due to this requirement, further reduction in the emission of high greenhouse effect gas, such as CFCs, is required. Therefore, the conversion of air conditioning refrigerant into the ones who has smaller greenhouse effect, even if it is dissipated into the atmosphere, became our responsibility.

Nevertheless, in case of air conditioning refrigerant, it would be the best if there is a refrigerant which has smaller impact on global warming, but ensures good energy efficiency and performance, and is safe; however, there is no such refrigerant which satisfies all these conditions. As a result, we have been considering the practical usage, within the safety frame-work, of R32 refrigerant which has short lifetime in the atmosphere, and has smaller effect of global warming, but is slightly flammable.

In 2004, due to the revision of air conditioner safety standards by the International Electro-safety Commission (IEC), the safety standards of air conditioners using slightly flammable refrigerant was issued. In 2010, the regulations of American Society of Heating, Refrigerating and Air-Conditioning Engineers in the United States (ANSI/ASHRAE34) was issued adopting the grades for refrigerants which are difficult to inflame due to their slow burning rates, and as a result have smaller damages in cases of fire. The burning rate of R32 is lower by 10cm / per second, and safety standardization for various usage is now being processed.

13.2 Characteristics of R32 Refrigerant

1. Chemical Characteristics

R32 is one of the refrigerants used in R410A, has almost no toxicity, and chemically stable compound formed by hydrogen, carbon and fluorine.

R32 has short lifetime of 4 to 9 years in case of being released into the atmosphere; therefore, it has smaller greenhouse gas effect but has slight inflammability because of the large proportion of hydrogen.

Chemical Characteristic Table of R32, R410A and R22.

	R32	R410A	R22
Chemical Formula	CH ₂ F ₂	CH ₂ F ₂ / CHF ₂ CF ₃	CH ₂ ClF ₂
Composition (mixture ratio wt.%)	Single Composition	R32 / R125A (50 / 50 wt.%)	Single Composition
Boiling Point (°C)	-51.7	-51.5	-40.8
Pressure (physical) *1	3.14	3.07	1.94
Capacity (physical) *2	160	141	100
COP (physical) *3	95	91	100
Ozone Depletion Potential (ODP)	0	0	0.055
Global Warming Potential (GWP) *4	675	2090	1810
Inflammability *5	Slightly Inflammable (A2L)	Non-inflammable (A1)	Non-inflammable (A1)
Toxicity	None	None	None

*1 : Physical property of temperature condition 50°C

*2 : Relative value of temperature condition 0/50°C, providing R22=100

*3 : Te/Tc/SC/SH=5/50/3/0°C

*4 : GWP=Global Warming Potential, each figure is based on “4th IPCC4 Report”

*5 : Based on ANSI / ASHRAE std. 34-2010

2. Characteristic of Pressure

As shown in Table 2, R32 does not have much difference in vapor pressure at the same refrigerant temperature comparing to R410A, but comparing to R22, it is higher at 1.6 times more. Thus, the same as in case of R410A, it is necessary to do installation and service using high-pressure tools and components.

Table 2. Saturated vapor pressure comparison table

(Unit: MPa)

Temperature	Refrigerant		
	R32	R410A	R22
-20	0.30	0.30	0.14
0	0.71	0.70	0.40
20	1.37	1.35	0.81
40	2.38	2.32	1.43
60	3.84	3.73	2.33
65	4.29	4.17	2.60

Reference : Thermal properties table of Japan Society of Refrigerating and Air Conditioning Engineers (60, 65°C)
NIST REFPROP V8.0 (-20 ~ 40°C)

13.3 Refrigerant piping installation • Tools used in services

13.3.1 Required Tools

R32 refrigerant air conditioners use the common parts as R410A air conditioners for two-way valves and three-way valves (diameters of service ports); thus, they maintain commonality in the maintenance of the compressive strength, the size of pipe flaring, and the size of flare nuts as R410A. Therefore, for refrigerant pipe installation and services, you can use tools for R410A.

However, mixing of refrigerants is not allowed, so that you have to separate the cylinders for the recovery of refrigerants.

Tools used for installation • relocation • replacement of air conditioning units

Works	R32	R410A	R22
Flaring	Flare tools for R410A (clutch type)		Flare tools for R22 (clutch type)
Connection of pipes	Torque wrench (diameter 1/4 3/8)		
	Torque wrench (diameter 1/2 5/8) *1		Torque wrench (diameter 1/2 5/8)
Manifold gauge charging hose	R32 & R410A Common (As at November 2013)		R22 Only
Air purging	Vacuum pump + Reducer / expander		Vacuum pump
Gas leakage test	Detection liquid or soup water, HFC detector		

*1. Nut diameters of 1/2 5/8, the size of torque wrench common with R410A

For other installation, you can use general tools such as screw drivers (+, -), metal saws, electric drills, long-nose pliers, hole core drills (ø70 or ø65), linen tape, levels, temperature gauges, clamp meters, electric knives, nippers, pipe cutters, reamers or scrapers, spring benders, (diameters 1/4 3/8 1/2 5/8), monkey wrenches, fixing wrenches (17 or 12 mm), feeler gauges, hexagon wrenches (4 mm), testers, megohm testers, etc.

Tools used for services

Works	R32	R410A	R22
Insertion of refrigerant	Digital scale for refrigerant charging, refrigerant cylinders, cylinder adopters and packing *a		
Recovery of refrigerant	Refrigerant recovery devices, refrigerant cylinders, manifold gauges, charging hoses *b		

*a. Use cylinder for each refrigerant, cylinder adopter and packing.

*b. Use refrigerant recovery cylinder separately for each refrigerant (**no mixture of refrigerant allowed**). Please be aware that there are some refrigerant collection devices which do not have self-certification.

13.3.2 Tools for R32 (common with R410A)

1. Flare gauges

Use flare gauges when you perform flaring with flare tools (crutch type). Flare gauges are used to set the pipe ends at 0.5 ~ 1.5 mm from clump bars of flare tools.

Flare gauges



2. Flare tools (clutch type)

Flare tools have larger holes of clump bars in order to set the pipe end at 0 ~ 0.5 mm, and have stronger springs inside to ensure solid flaring torques. These flare tools can be used commonly for R22.

Flare tools (clutch type)



3. Torque wrenches (diameters 1/2, 5/8)

In order to strengthen the compressive strength, the diameters of wrenches change depending on the flare nut sizes.

Torque wrenches

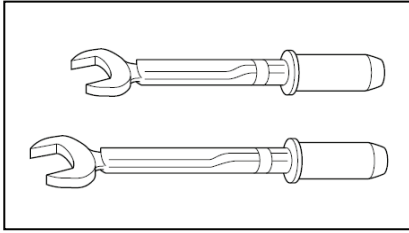

Differences in torque wrenches

	R32 (common R410A)	R22
1/2 (diameter × torque)	26 mm × 55 N•m (550 kgf•cm)	24 mm × 55 N•m (550 kgf•cm)
5/8 (diameter × torque)	29 mm × 65 N•m (650 kgf•cm)	27 mm × 65 N•m (650 kgf•cm)

4. Manifold gauges

R22 gauges cannot be used because of the high pressures.

Each port of manifold has different shapes in order to prevent inserting wrong refrigerant.

*However, the port shape for R410A and R32 is the same; therefore, attention need to be paid not to insert wrong refrigerant.

Differences in high/low pressure gauges

	R32 (common R410A)	R22
High pressure gauges (red)	-0.1 ~ 5.3 MPa -76 cmHg ~ 53 kgf / cm ²	-76 cmHg ~ 35 kgf / cm ²
Low pressure gauges (blue)	-0.1 ~ 3.8 MPa -76 cmHg ~ 38 kgf / cm ²	-76 cmHg ~ 17 kgf / cm ²

Difference in manifold port sizes

	R32 (common R410A)	R22
Port sizes	1/2 UNF20	7/16 UNF20

5. Charging hoses

The pressure resistance of charge hoses is increased. At the same time, the material is changed to HFC resistant, and the size of each manifold adopter is changed, as the port size of manifold gauge itself. Further, some hoses are with anti-gas pressure backflow valves placed near the adopters. (hoses with the valves recommended)

Manifold gauges / Charging hoses

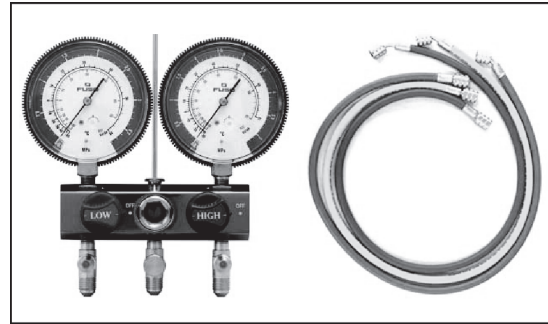

Differences in charging hoses

		R32 (common R410A)	R22
Pressure Resistance	Normal operation pressure	5.1 MPa (52 kgf / cm ²)	3.4 MPa (35 kgf / cm ²)
	Burst pressure	27.4 MPa (280 kgf / cm ²)	17.2 MPa (175 kgf / cm ²)
Material		HNBR rubber Internal nylon coating	NBR rubber

6. Vacuum pump Vacuum pump adopter

When using a vacuum pump, it is necessary to set a solenoid valve in order to prevent backflow of vacuum pump oil into the charge hoses, and use a vacuum pump with oil backflow prevention function, or use the vacuum pump with vacuum pump adopter.

If vacuum pump oil (mineral oil-based) mixes with R410A (R32), it may cause damage to the machine.

Vacuum pump

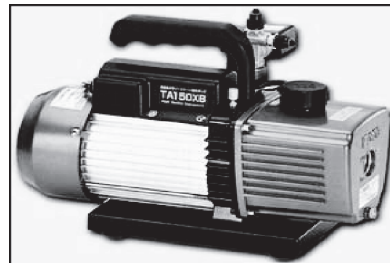

Vacuum pump adopter

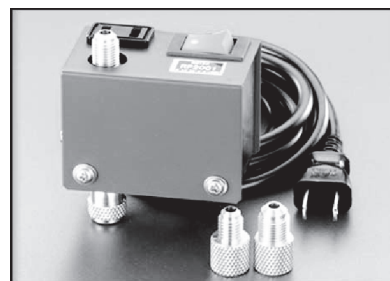

7. HFC refrigerant_Electric gas leakage tester
 R32 refrigerant is often used for other mixed refrigerant (R410A, R404A, R407C etc.). Therefore, the usage of existing HFC detectors is possible, but in order to detect more accurately, we recommend to use detectors specially set and adjusted for R32 detection.

HFC refrigerant_Electric gas leakage tester



8. Digital scale for refrigerant charging
 R32 and R410A have high pressure level and their evaporation speed is high. Thus, if you recover the refrigerant by cylinder charging method, the refrigerant evaporates within the weighing scale glass, which makes reading the scale difficult, rather than liquidating the refrigerant into the cylinder. (Charging cylinders for R22 have different pressure resistance, scale, connection port size; therefore, they are not usable) At the same time, the digital scale for refrigerant charging is strengthened by receiving the weight of the refrigerant cylinders with four pillars at the corners. The connection ports of charging hoses have two separate ports for R22 (7/16 UNF20) and R32/R410A (1/2 UNF20) therefore, they can be used for the insertion of the existing refrigerants.

Digital scale for refrigerant charging

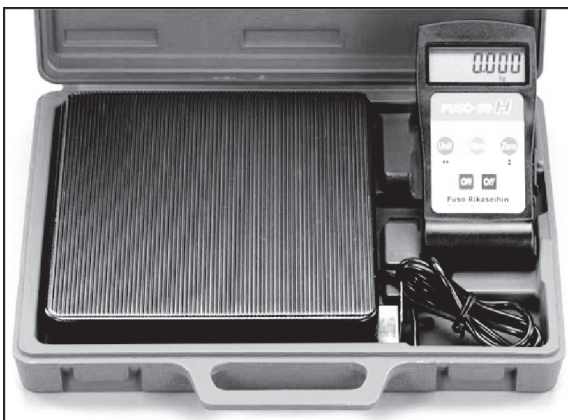

9. Refrigerant cylinders
 Refrigerant cylinders for R410A are painted in pink, and the ones for R32 are painted in other colors that might subject to change according to the international standards. R32 is a single refrigerant, so that both liquid and gas insertion are possible. Additional charging is also possible. (R410A is a mixed refrigerant, so only liquid insertion is possible)

Refrigerant cylinders



10. Connection ports of refrigerant cylinders and packing
 Charging ports which fit to the charging hose connection port size (1/2 UNF20) is needed. At the same time, the packing has to be of HFC resistant materials.

Connection ports and packing

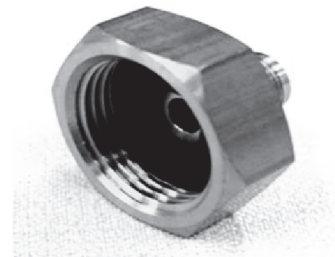

11. Tools used for refrigerant piping installations and services

	Tools for R410A	Common with R32	Possibility of usage for R22
1.	Pipe cutters, reamers or scrapers	○	○
2.	Flare tools (clutch type)	○	○
3.	Torque wrench (1/4, 3/8)	○	○
4.	Torque wrench (1/2, 5/8)	○	×
5.	Manifold gauges · charging hoses	○	×
6.	Vacuum pumps, vacuum pump adopters	○ Connection 5/16	○ Connection 1/4
7.	Electric gas leakage testers for HFC *1	○	△
8.	Digital scale for refrigerant charging	○	○
9.	HCF recovery devices (connection port 5/16) *2	○ Connection 5/16	○ Connection 1/4
10.	Refrigerant cylinders (pressure resistant: FC3)	Same specs ×	×
11.	Refrigerant cylinders (pink)	Other (colors that might subject to change according to the international standards).	×
12.	Refrigerant cylinder connection ports and packing	○	×
13.	Allen wrench (4 mm) Electric knives	○	○
*1	Those testers only for HCFC22 (R22), but not for HCF32 (R32) and HCF410A (R410A) cannot be for common use.		
*2	Recovery devices which are self-certified for each HCF type can be used.		
	<p>[Knowledge for the common usage of tools for R410A & R32]</p> <ul style="list-style-type: none"> • R410A and R32 machines use different compressor oils. • If unregulated compressor oil gets mixed into, it may cause damage to the machine function. • Careful pump down will ensure the recovery of compressor oil, and it will minimize the remaining amount of the oil in the manifold gauge and charging hose. • If you only perform the recovery of refrigerant and not be able to perform pump down, <u>you have to dispose the compressor oil in the charging hose.</u> 		
	<p>[Precaution of repairing refrigerant cycle]</p> <ul style="list-style-type: none"> • In the brazing, open 2-way and 3way valves, and make sure the refrigerant is completely recovered back and not remaining the system. • When repairing outside, make sure no refrigerant is in the air, ensure good air flow, and perform the brazing. 		
	<p>[Inserting wrong refrigerant]</p> <ul style="list-style-type: none"> • It may cause “not cooling” and “not heating” customer claims because each component (expansion valve, compressor, PCB) of the refrigeration cycle is specially adjusted for R32. • At the same time, it is not subject to product warranty, if wrong refrigerant was inserted into the system. 		

13.4 New installation, Relocation, Repairing of Refrigerant Cycle System The Procedures

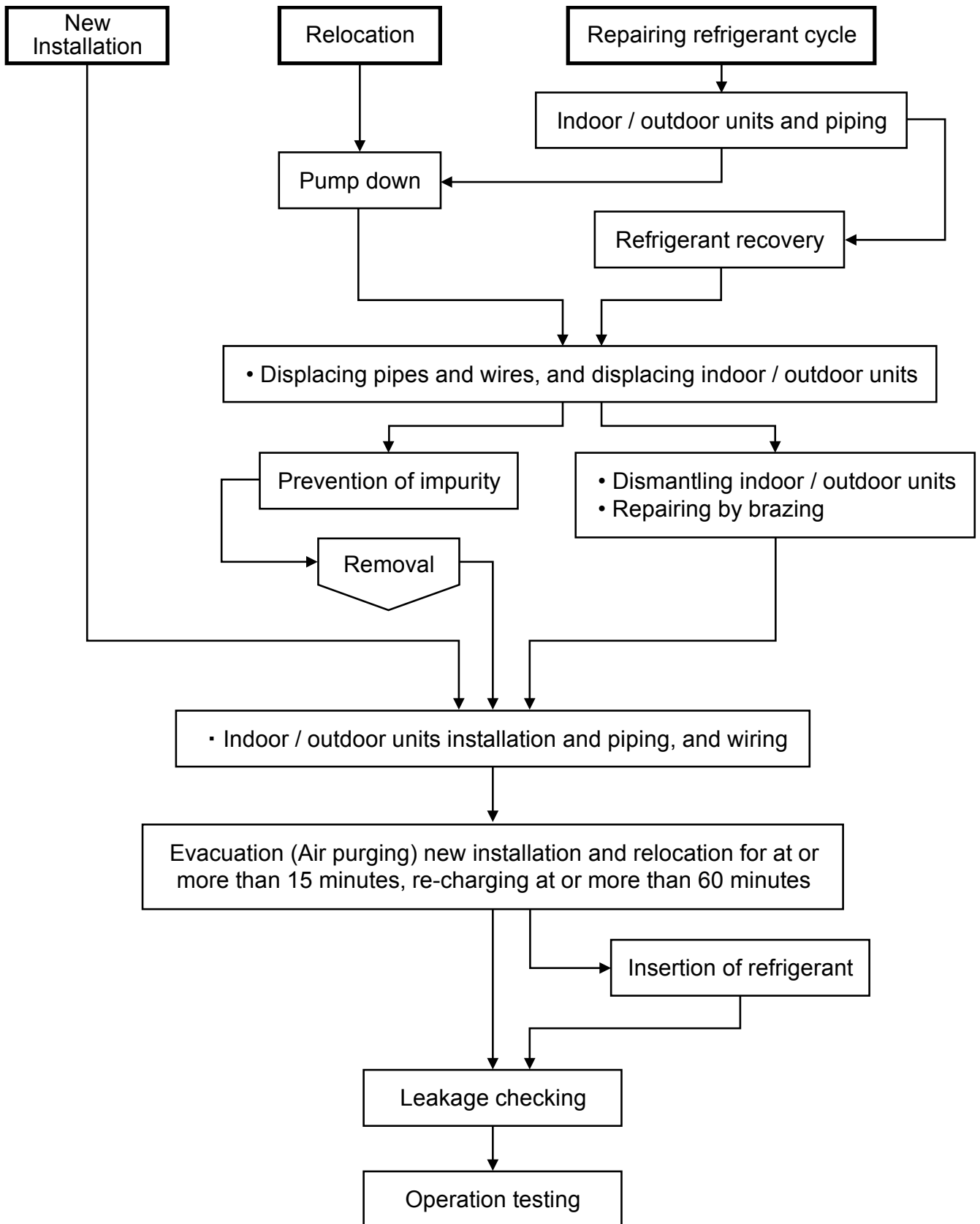

13.5 Piping installation of R32

13.5.1 Pipe materials used and flaring

Copper pipes are used for refrigerant piping. Pipes which comply with JIS Regulations need to be used. Room air conditioners which use R410A and R32 have higher pressure; thus, using pipes which comply with the Regulations is important.

The pipe thickness is regulated by revised JIS B 8607 "Flaring and brazing fittings for refrigerant" and the pipe thickness for R410A, R32 is shown in the table.

Pipe thickness

O and OL materials		Thickness (mm)		
Diameter	Diameter (mm)	R410A	R32	R22
1/4	6.35	0.80		
3/8	9.52	0.80		
1/2	12.70	0.80		
5/8	15.88	1.00		

Caution

- For connection piping, use copper phosphate seamless pipes (1220T) as regulated in "JIS H 3300" and the pipe thickness is 0.8 mm.
- In the market, there are some pipes of 0.7 mm thickness, but do not use these pipes (0.8 mm thickness has to be strictly followed).
- It is recommended to use pipes whose adhesion amount of oil is at or less than 40 mg / 10 m. At the same time, do not use pipes with dent, de-shape, and color change (especially inside).

13.5.2 Processing and connection of pipes

For refrigerant pipe installation, be aware of moisture and dirt do not get into the pipes, and make sure of no refrigerant leakage.

◎ The procedure of flaring and precautions

- Cutting of pipes : use pipe cutter and cut the pipe slowly not to de-shape the pipe.
- Removal of burrs on the edge of pipe (reamer or scraper)
If the condition of pipe edge after the deburring is no good or if burrs attaches on the flaring, it may cause refrigerant leakage. Turn the pipe end down and perform deburring carefully.
- Insert the flare nut (use the nut which is a part of the CZ parts)
- Flaring

Ensure the cleanliness of clump bar and pipe, and perform flaring carefully.

Use the existing flare tools or flare tools for R410A. Be aware that the sizes and dimensions of flaring is different in each flaring tool. If you use the existing flaring tools, use flaring gauge to measure the length of the flaring part.

Piping size (mm)	Dimensions "a" (mm) R22			Dimensions "a" (mm) R410A/R32			Nut outer diameter (mm)	
	Flare tools		Flare tools for R410A	Flare tools		Flare tools for R410A	R22	R410A
	Clutch type	Wing nut type	Clutch type	Clutch type	Wing nut type	Clutch type		R32
6.35 (1/4")	0.5 ~ 1.0	1.0 ~ 1.5	0 ~ 0.5	1.0 ~ 1.5	1.5 ~ 2.0	0 ~ 0.5	17	17
9.52 (3/8")	0.5 ~ 1.0	1.0 ~ 1.5	0 ~ 0.5	1.0 ~ 1.5	1.5 ~ 2.0	0 ~ 0.5	22	22
12.70 (1/2")	0.5 ~ 1.0	1.5 ~ 2.0	0 ~ 0.5	1.0 ~ 1.5	2.0 ~ 2.5	0 ~ 0.5	24	26
15.88 (5/8")	0.5 ~ 1.0	1.5 ~ 2.0	0 ~ 0.5	1.0 ~ 1.5	2.0 ~ 2.5	0 ~ 0.5	27	29

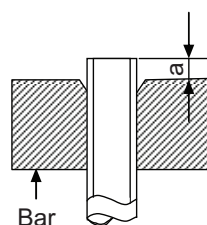

13.6 Installation, Relocation, and Service

13.6.1 Air purge and gas leak test for new installation (using new refrigerant pipes) using vacuum pump

(From the point of view of global environment protection, do not release CFCs into the atmosphere during installation work)

1. Connect the charging hose of manifold gauge to the service port of 3-way valve (pushing insect pin).
2. Fully open the handle Lo of manifold gauge and operate vacuum pump.
(If the needle of the low-pressure gauge reaches the vacuum immediately, check 1 procedure again)
3. Perform vacuuming 15 minutes or more, and make sure low pressure gauge reaches to -0.1 MPa (-76cmHg).
When the vacuuming completes, fully open the handle Lo of manifold gauge and stop the operation of vacuum pump, and leave it for 1 ~ 2 minutes. Then, remove the connection side of the charging hose of vacuum pump adaptor after checking the needle of manifold gauge does not turn back.
4. Open the stem of 2-way valve to 90° in anti-clock wise, and close the 2-way valve after 10 seconds, and perform gas leakage test.
5. Remove the charge hose from the service port of 3-way valve, and open the stems of 2-way and 3-way valves (open the valves to anti-clock wise carefully, do not use full strength to open)
6. Tighten the service port cap with torque wrench $18\text{ N}\cdot\text{m}$ ($1.8\text{ kgf}\cdot\text{m}$)
Tighten the caps of 2-way and 3-way valves with torque wrench $18\text{ N}\cdot\text{m}$ ($1.8\text{ kgf}\cdot\text{m}$)
7. After the tightening of each cap, check gas leakage around the cap.

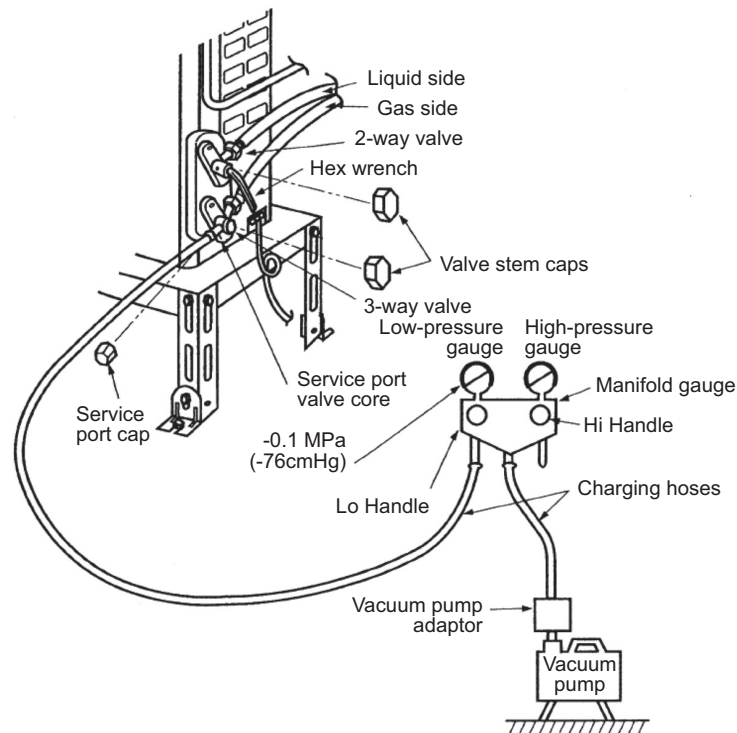

13.6.2 Process of refrigerant recovery

1. Connect the center charging hose of manifold gauge to the in-let side of recovery device.
2. Connect the valves of the discharge side of recovery device and liquid side of refrigerant cylinder with red hose (charging hose).
3. Connect the yellow float switch cable of the recovery device to the refrigerant cylinder.
4. Open the low pressure side valve of manifold gauge.
5. Slightly loosen the charging hose of in-let connecting side of recovery device and perform air purge.
6. Open the liquid valve of refrigerant cylinder and slightly loosen the charging hose in discharging side of recovery device, and perform air purge (the recovery cylinder needs slight inside pressure).
7. Insert electric plug of recovery device into electrical outlet (the fan operation starts).
8. Turn the valve 1 and 2 of recovery device to pressure equalization point.
9. After a few seconds, turn back the valve 1 and 2 to the original position.
10. Turn the switch of the recovery device to "ON". (the compressor operation starts)
11. When the low pressure of manifold gauge is close to "0", close the low pressure side valve, turn "OFF" the recovery device switch.
12. Remove the center charging hose of manifold gauge from the recovery device.

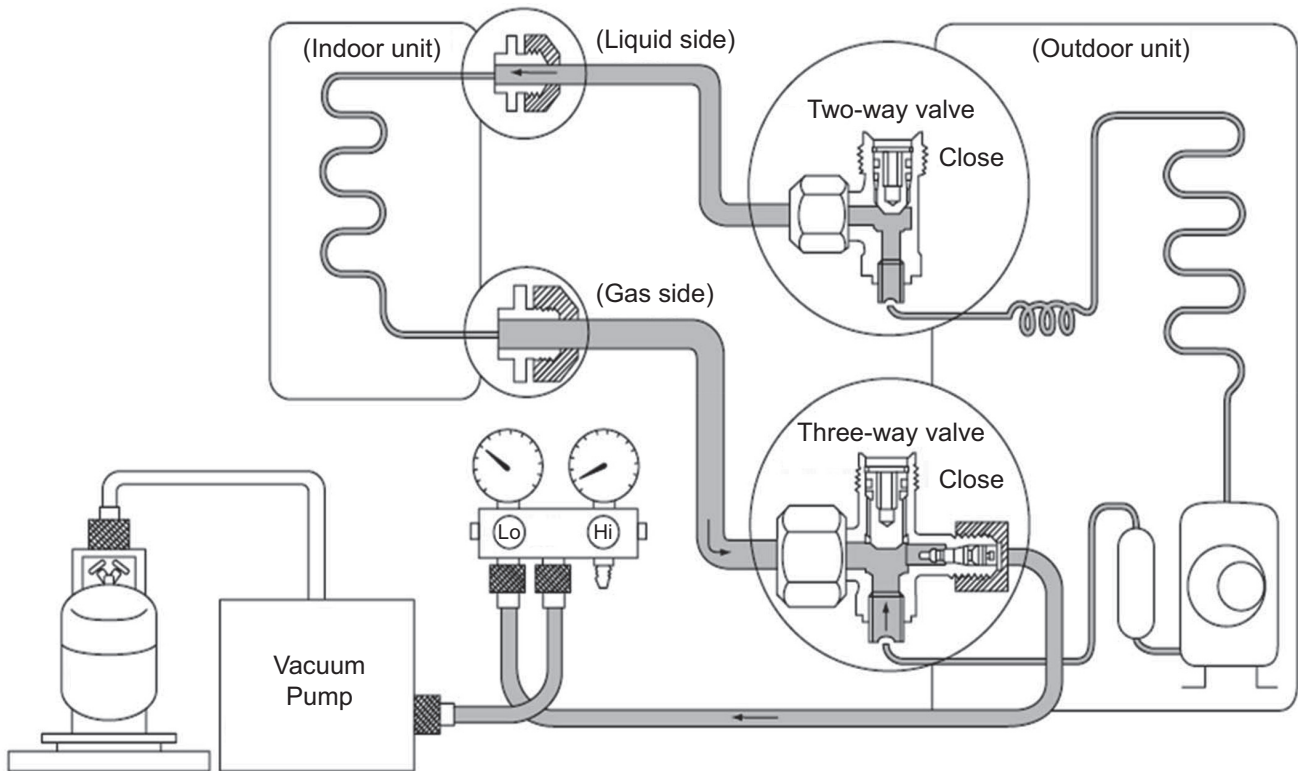

13.6.3 Relocation

1. Removing the air conditioning unit

a) Recovery of outdoor unit refrigerant by pumping down

Press “forced cooling button” (as a general rule, since 1998 the name of cooling testing button is changed, and this name is unified within the air conditioning industry), and then you are able to start cooling operation in which the room temperature is low, and you can recover the refrigerant from the outdoor unit.

1. Check the valve stems of two-way and three-way valves are open by being turned to anti-clockwise (Remove the caps, and confirm the bars are fully open. Use hexagon wrench <4 mm> to open and close the valves).
2. Press the “Emergency Operation” button of the indoor units for five seconds and release [Forced cooling operation] (for old models, press “forced cooling” button). Then, operate the air conditioning unit for about 10 minutes.
3. Turn the stem of the two-way valve to the clock-wise and close the valve.
4. After about 2 ~ 3 minutes, turn the stem of the three-way valve quickly to the clock-wise, and stop the operation.

Caution: In the pump down operation, stop the compressor before removing the refrigerant pipes.

If you do not stop the compressor operation, and if the valve is open and remove the refrigerant pipes, the air may be sucked into the system and causes extreme high temperature in the refrigerant cycle. This may result in rupture or injury, etc.

5. Attach and tighten the caps of two-way and three-way valves with torque wrench.
6. Remove the connecting pipes (liquid side and gas side).

b) Removal of indoor and outdoor units

1. Remove the connecting pipes and wires between the indoor and outdoor units.
2. Attach capping flare nuts on the edges of the pipes, connecting the indoor and outdoor units, in order to prevent dust and moisture get into the pipes.
3. Remove the indoor and outdoor units.

2. Unit installation

Use new refrigerant pipes for the installation, and perform air purging using vacuum pump and gas leakage testing stated in 14.5.1.

13.6.4 Replacement of air conditioning units and evacuation (when re-using the existing pipes)

When replacing the air conditioning units, you might use the existing pipes, but it is recommended to perform flaring again. In case of unit replacement, even if the unit is new refrigerant air conditioner, if the refrigerant oil is different, it may cause problem. Further, when re-using the existing refrigerant pipes, it is recommended to evacuate the pipes as much as possible, due to the reason that much refrigerant oil may be attached on the surface of the pipes. If the pipes are used without evacuation, the remaining refrigerant oil may cause under-performance and abnormal refrigerant cycle caused by non-compatibility of those oils.

13.6.5 Inter-changeability of refrigerant

Do not operate air conditioning units inserting wrong (or mixed) refrigerant (R22, R410A, R32). It may cause malfunction of the units, and at the same time, may cause serious incident such as rupture of the refrigerant cycle.

13.6.6 Re-insertion of refrigerant in service

When re-insertion is needed, follow the procedures to ensure the insertion of new refrigerant at correct amount.

1. Attach charging hose (blue) to the service port of the outdoor unit.
2. Attach charging hose (red) to the vacuum pump. Fully open the 2-way and 3-way valves.
3. Place the refrigerant cylinder on the digital scale for refrigerant charging and connect the charge hose (yellow) to the connection port of the vacuum pump and the digital scale. Leave the cylinder valve fully open.
4. Fully open the handles Lo and Hi of the manifold gauge, and switch on the vacuum pump, and then perform evacuation for at or more than one hour.
5. Confirm the compound gauge of -0.1 MPa (-76 cmHg) and fully open the handles of Lo and Hi, and switch off the vacuum pump. Leave it for about 1 ~ 2 minutes and confirm the needle of the compound gauge does not turn back.
Refer to the picture below to follow the procedures below.
6. Remove the charging hose (red) of the manifold gauge from the vacuum pump adaptor.
7. After adjusting the digital scale to zero, open the cylinder valve and the valve Lo of the manifold gauge, and insert the refrigerant.
8. If it is not possible to insert the refrigerant at regulated amount at once, operate the cooling mode and gradually insert the refrigerant (recommended amount approx. $150 \text{ g} / 1 \text{ time}$)
*Do not insert much refrigerant at once.
9. Close the open/close valve and insert the refrigerant in the charging hose to the outdoor unit.
*Perform this procedure during operating cooling operation. Close the stem of the two-way valve, and when the pressure of the manifold gauge becomes zero (0), quickly remove the charging hose (blue). Immediately open the 2-way valve, and stop the cooling operation.
10. Final checking ••• Confirm the 2-way and 3-way valves are fully open.
Attach the caps of the service port and control valve, and then check the gas leakage around the caps.

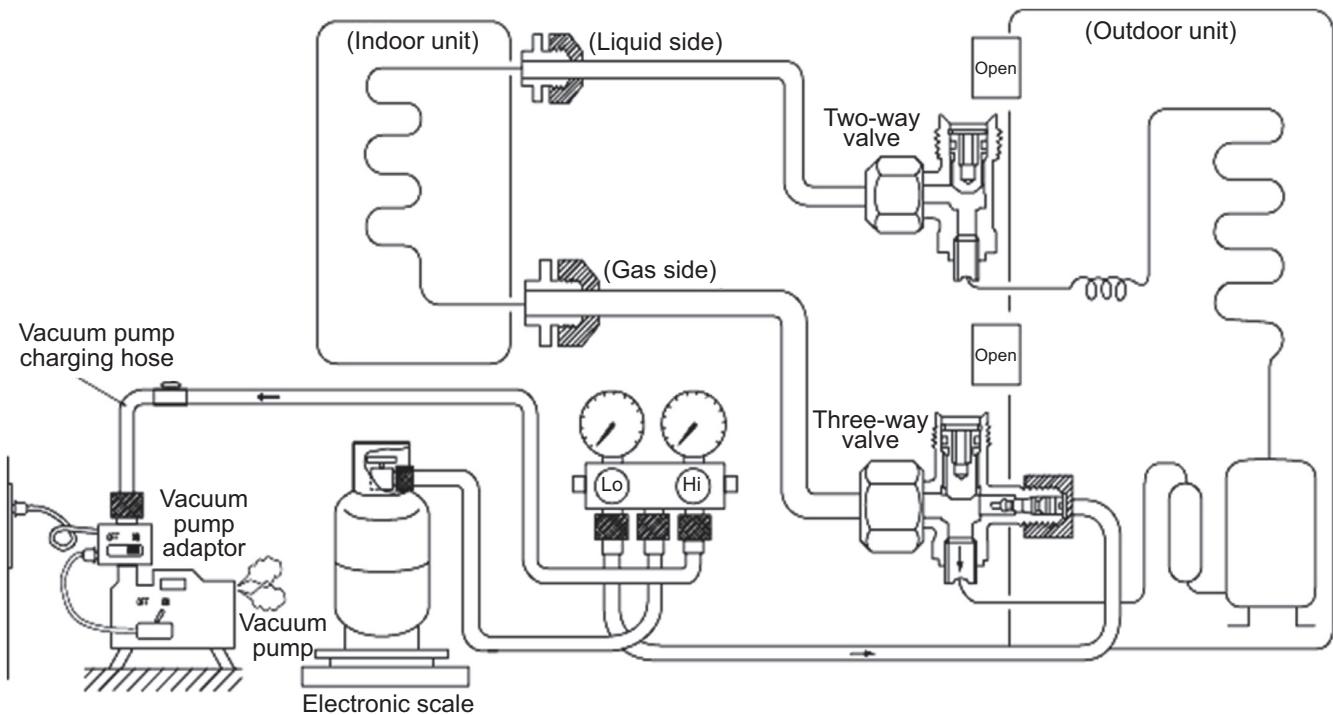

13.7 Repairing of refrigerant cycle / Brazing point

13.7.1 Preparation for repairing of refrigerant cycle / brazing

Brazing which is a technique needed for repairing refrigerant cycle requires advanced technique and experience, and this brazing procedure can only be performed by the workers who completed "Gas Welding Skill Training" regulated by the Occupational Safety and Health Act, and went through the training programs of refrigerant operations. Dismantling and re-connecting (assembling) refrigerant system requires working space, and the space has to ensure good air flow and fire prevention (water bucket and fire extinguisher). Moreover, the worker has to ensure the wearing of goggles, gloves, safety shoes, and long sleeve shirts, and be aware of work safety and attempt to prevent secondary defect (quality assurance of products). For brazing the indoor / outdoor unit structural components (heat exchangers, compressors, expansion valves, four-way valve blocks), after the recovery of all refrigerant, confirm that no refrigerant remains in the system, and fully open the 2-way and 3-way valves. When the brazing is conducted outside, check and make sure no refrigerant is contained in the air (be careful with vaporized refrigerant). Furthermore, protect the compressor terminal with metal plates, and heat but use wet clothes to cool down (releasing the heat) the expansion valves, and four way valves (prevent destruction of parts). In brazing, it is important to pour the brazing material without melting the base metal based on capillary action principle. In case of holes and oxidizing caused by overheating, do not perform re-brazing or alteration but replace the parts.

13.7.2 Adjustment of vacuum pump pressure

1. Cylinder with adjustment handle

1. Check and confirm the adjustment handle of the 1st pressure adjuster is loosen (anticlockwise). If cylinder valve is opened when the 1st gauge pressure adjust handle is closed, the 2nd gauge might get broken.

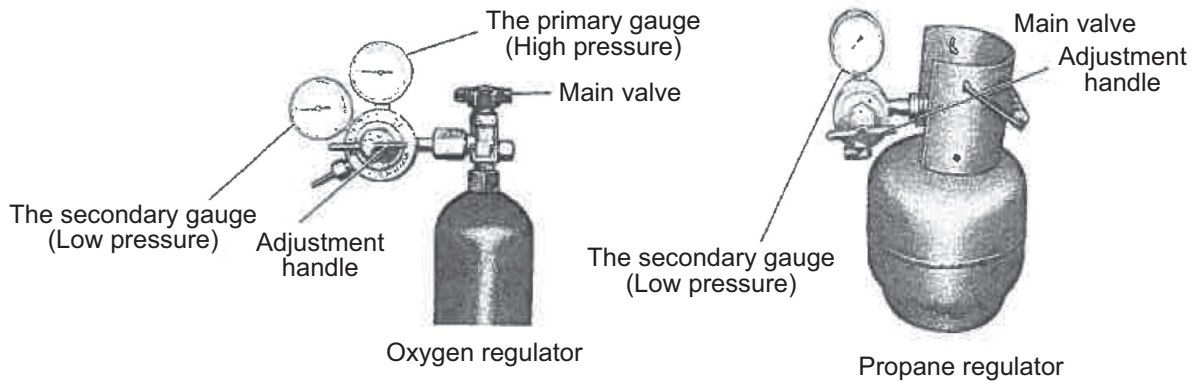

2. Open the cylinder valve, and check the remaining amount with the first side pressure gauge.
3. Check the pressure of 2nd gauge and turn the adjustment handle to clock-wise direction to adjust the pressure.
 - ⊙ Oxygen 2nd side gauge pressure 0.5 MPa (5.0 kgf / cm²)
 - ⊙ Propane 2nd side gauge pressure 0.05 MPa (0.5 kgf / cm²)

2. Cylinder without adjustment valve

2nd side gauge pressure is adjusted by the adjuster.

Check the both side valves of the torch and open the cylinder valve to check the remaining refrigerant in the cylinder.

Caution: Do not attach oil component on the connection port of the adjuster.

Especially, use an oxygen cylinder adjuster which is no oil substance type. Do not dismantle or repair the adjuster and pressure gauge.

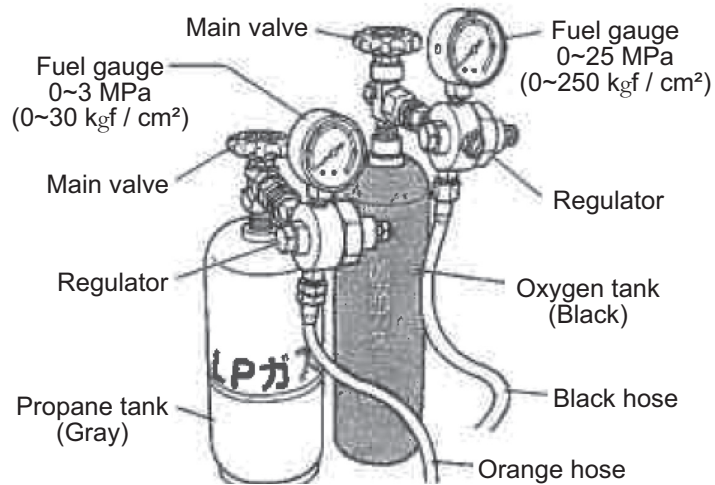

13.7.3 Checking of gas provision

Checking there is no fire around the torch, and then confirm the provision of gas.

1. Slightly open the "propane valve" of the torch, and make sure the gas comes out from the torch crater and then close the "propane valve".
2. Slightly open the "oxygen valve" of the torch and make sure the gas comes out from the torch crater and then close the "oxygen valve".

Check there is no gas leakage around the hose connection.

13.7.4 Adjustment of flame

1. Slightly open the "propane valve" of the torch and lit with spark lighter. This moment, the flame is only by propane and the color is red.
2. Gradually open the "oxygen valve" of the torch to mix oxygen, and adjust the amount of propane and oxygen with the valve to make the flame suitable for brazing work.

If the white core flame splits into two, the torch crater might be clogged. In this case, remove the crater from the torch and check.

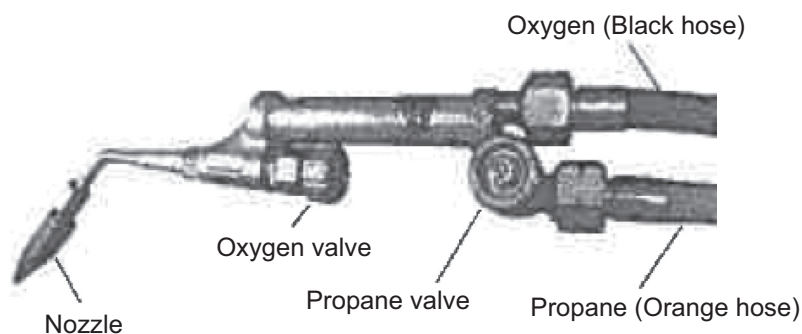

13.7.5 Types of flame

Types of flame change based on the proportion of propane and oxygen.

[Neutral Flame]

Perform brazing with this flame

(This is a flame when oxygen and propane are mixed at proper proportion, and has lesser effect on the brazed metals)

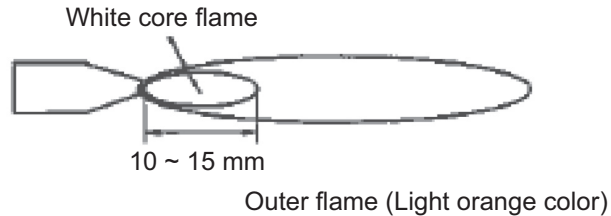

[Carbide Flame]

When propane is excessive, the flame has white color flame in between the white core flame and outer flame.

(This is due to the lack of oxygen and the proportion of unburned propane is excessive.)

The black carbon created during the brazing work may contaminate the surface of the brazed metal).

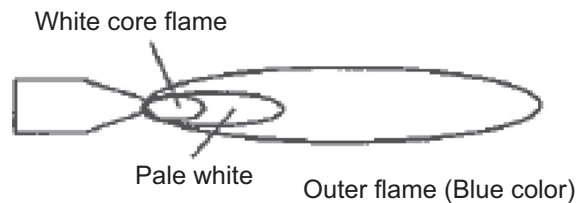

[Oxidizing Flame]

Oxygen is more compared to the neutral flame. Although the flame size is small, this has the highest flame heat.

However, due to the excessive oxygen contained in the flame, the brazing point gets oxidized. (This flame may cause holes, due to the high heat. The pipe may get melt)

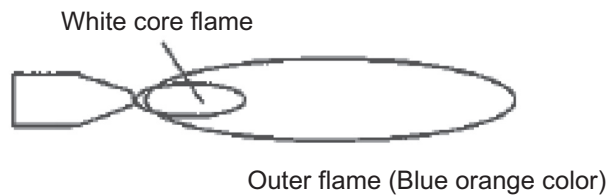

13.7.6 Closing the flame

[In case of short break]

1. Close the "propane valve" of the torch.
2. Close the "oxygen valve" of the torch.

[In case of finishing work]

1. As above, close the flame following the procedure of "In case of short break"
2. Completely close the valves of oxygen and propane cylinders
3. Release the remaining gas inside the hose by opening the "oxygen valve" and "propane valve" of the torch.
4. Confirm the 1st and 2nd side gauge pressures of "oxygen" and "propane" cylinder pressure adopter are "zero".

13.7.7 Selection of brazing material

Use BA_g brazing material (silver solder) to increase the welding performance.

Category	JIS Standard Number	Composition of ingredients (%)						Temperature (°C)			Tensile strength (Reference)		Characteristics and applications
		Ag	Cu	Zu	Cd	Ni	P	Solidus	Liquidus	Brazing temp	Kgf·cm ²	Base material	
BA _g	BA _g • 1A	49.0 ~ 51.0	14.5 ~ 16.5	14.5 ~ 18.5	17.0 ~ 19.0	—	—	approx. 625	approx. 635	635 ~ 760	45.5	S20C	Liquidity is good at low temperature, it is preferable to a small junction of the gap in the universal form.
	BA _g • 1	44.0 ~ 56.0	14.0 ~ 16.0	14.0 ~ 18.0	23.0 ~ 25.0	—	—	approx. 605	approx. 620	620 ~ 760	45.5	S20C	It has similar performance to the BA _g • 1A, and suitable for every base material except the light weight metal.
	BA _g • 2	34.0 ~ 36.0	25.0 ~ 27.0	19.0 ~ 23.0	17.0 ~ 19.0	—	—	approx. 605	approx. 700	700 ~ 845	45.5	S20C	It is a brazing filler metal in universal form, suitable for a slightly larger gap junction.
	BA _g • 3	48.0 ~ 51.0	14.5 ~ 16.5	13.5 ~ 17.5	15.0 ~ 17.0	2.5 ~ 3.5	—	approx. 630	approx. 690	690 ~ 815	35 ~ 70	SS ~ SUS	It has good corrosion resistance in stainless steel-based brazing, suitable for brazing tungsten carbide, aluminum bronze and copper.
BCuP	BCuP-2	—	remain	—	—	—	6.8 ~ 7.5	approx. 710	approx. 785	690 ~ 815	21 ~ 24.5	Cu	Good liquidity, suitable for brazing copper tube.
	BCuP-3	4.8 ~ 5.2	remain	—	—	—	5.8 ~ 6.7	approx. 645	approx. 815	720 ~ 815	21 ~ 24.5	Cu	Suitable for brazing when the joint spacing is not constant
	BCuP-5	14.5 ~ 15.5	remain	—	—	—	4.8 ~ 5.3	approx. 645	approx. 800	705 ~ 815	21 ~ 24.5	Cu	When brazing of copper and copper, it is used without a flux, but not possible for brazing basic materials

Caution

BCuP (phosphorus copper wax) is easy to react with sulfur, and makes a brittle compound water soluble, and causes gas leakage. In hot spring areas, use other brazing materials or paint the surface for protection.

13.7.8 Need of flux

Use flux to protect the base materials.

1. Remove impurity and oxide film on the metal base, and improve the flow of the brazing material.
2. Prevent oxidation of the metal surface in brazing.
3. Reduce the surface tension of the brazing material.

13.7.9 Need of nitrogen gas

In order to prevent oxidation in the pipe, perform the brazing operation in nitrogen gas flow. Flow rate 0.05 m³ / h, or pressure reducing valve at 0.02 MPa (0.2kgf / cm²) below.

13.7.10 Checking of brazing (insert) points

1. No impurity on the brazing point
If dirt or oil is attached on the brazing point, the brazing filler metal does not reach to junction, and it may cause poor welding.
2. Adequate gap space in the brazing point
The advantage of capillary current situation is used in brazing. If the gap space is too large, this phenomenon may not occur and it may cause poor welding because brazing filler metal does not flow to join the front part.

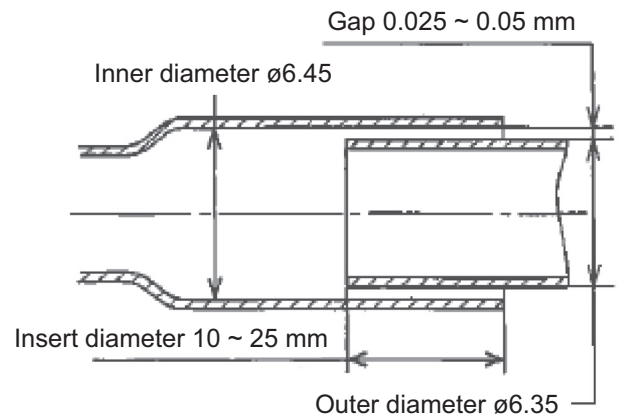

3. Appropriate size for insertion
The guideline for pipe insertion dimensions is to three times the diameter of the base material, but you need to decide the insertion size in consideration of the clogging of the brazing material. Generally, for thin pipes, you need to increase the insert size, and for thick pipe vice versa.

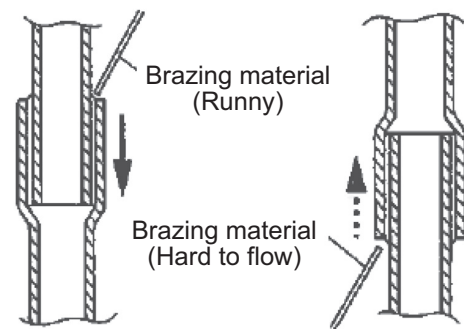

4. Brazing material to flow from top to bottom
Brazing filler metal will easily flow to the connecting portion by capillary action. Further, by bending the brazing portion of [dryer side] of the capillary tube at 15 mm from the tube top to the angle of about 120°, you can prevent the damage of dryer inside and the clogging of brazing material caused by the excessive insertion of capillary tube.

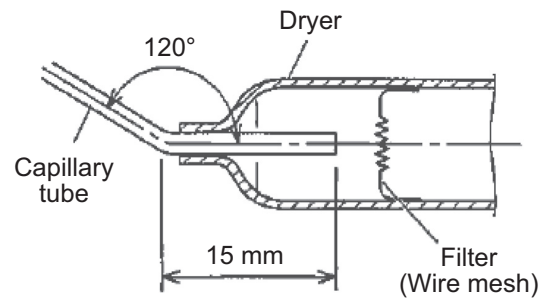

13.7.11 Brazing and heating

1. Place the flame to a pipe which has more heat capacity in order to let the brazing material melt by the pipe heat. Heat the pipe up to the melting temperature of the brazing material, but when it is overheating, assess the temperature by pipe color in order not to melt the pipe.

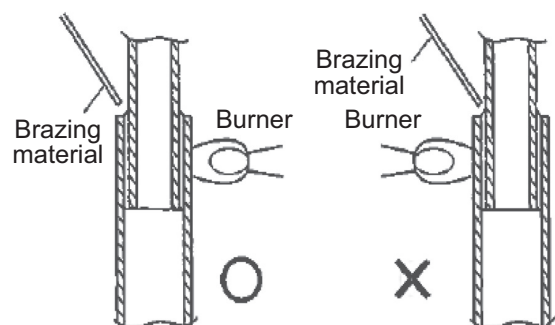

The pre-heating is to heat the base material until the melting temperature, and requires certain training to distinguish the color of the heated base material in order not to melt the material.

The color and temperature of copper tube

- Becoming red color 480°C
- Dull red 650°C
- Cherish red 760°C
- Brightening cherish red 870°C

(Reference)

Melting temperature of copper •••••••• Approx. 1083°C

Maximum temperature obtained in propane and oxygen •••••••• Approx. 1083°C

The important point is to heat the bonding part uniformly within a short period of time until reaching to the brazing temperature in the following manner.

2. Apply the flame on to the side with better heat transmission. If the pipe thickness is consistent, by heating like 30% iron and 70% copper, the copper pipe inside reaches to brazing temperature.
Iron pipes have low heat transmission and only the part the flame is applied get high temperature, and this causes oxidization of the pipe. The flow of the brazing filler is affected negatively.
3. Apply the flame on to the side of larger heat capacity.
When brazing a thin tubes such as capillary tube and dryer, etc., caution has to be taken to apply the flame to the dryer side (thick pipe side), in order to prevent burn out by the heat.
4. When brazing the compressor connection pipes (suction and discharge), remove the sound insulation plate and the fan, and place the compressor stand vertically (to prevent the leakage of compressor refrigerating machine oil), and apply the flame from the compressor body side.

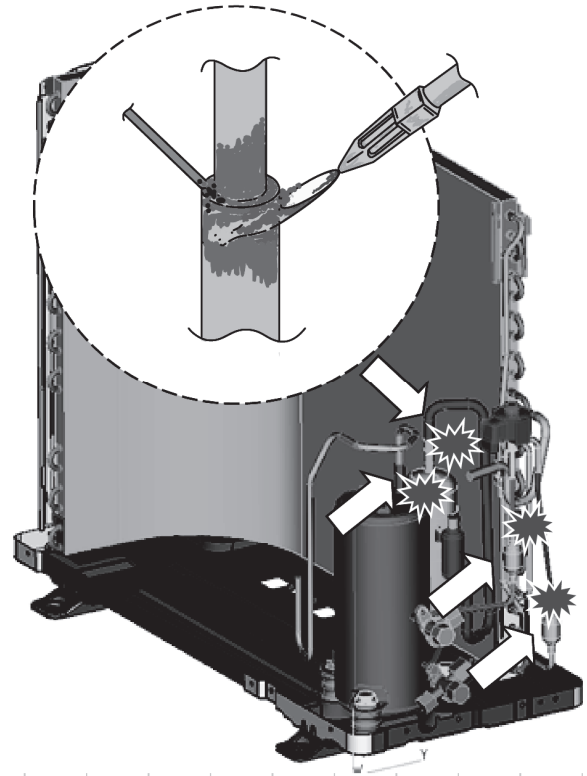

13.7.12 Terminologies of brazing

Pin holes → Small holes are generated on the surface of the brazing metal.

Wet temperature → Liquidus temperature at which the brazing material starts flowing out by heating, generally it is the liquidus-line temperature.

Blow holes → Hollows made by gas in the brazing material of brazing portion (gas reservoirs).

Pits → As a result of blow holes, small dents generated on the outside surface of welding.

Voids → The brazing material does not reach completely to the brazing part. It cannot be identified from outside.

13.8 <Reference> Analysis method for no error code, no cooling / no warming

13.8.1 Preparation for appropriate diagnosis

In order to obtain appropriate operation characteristics, minimum 15 minutes or more operation time [testing operation (rated operation)] is required.

1. Method of rated operation (rated operation)

For the models which have two buttons of "emergency operation and forced cooling operation", press forced cooling button once. For the models which have only emergency operation button, press the button once for 5 seconds and when hear "beep" sound, release the button. Then, cooling operation starts.
2. Checking the mal-functions of indoor / outdoor units
 - 1) Any obstacles against heat release and air suction? (short circuit)
(Forget to remove the outdoor unit cover or fallen leaves blocking the outdoor unit)
 - 2) Are the indoor unit air filters clean? (obstructing heat suction)
 - 3) Is the setting temperature on the remote controller correct? (is the setting temperature set at lower/higher than the room temperature?)

13.8.2 Understanding and verification of refrigerant cycle

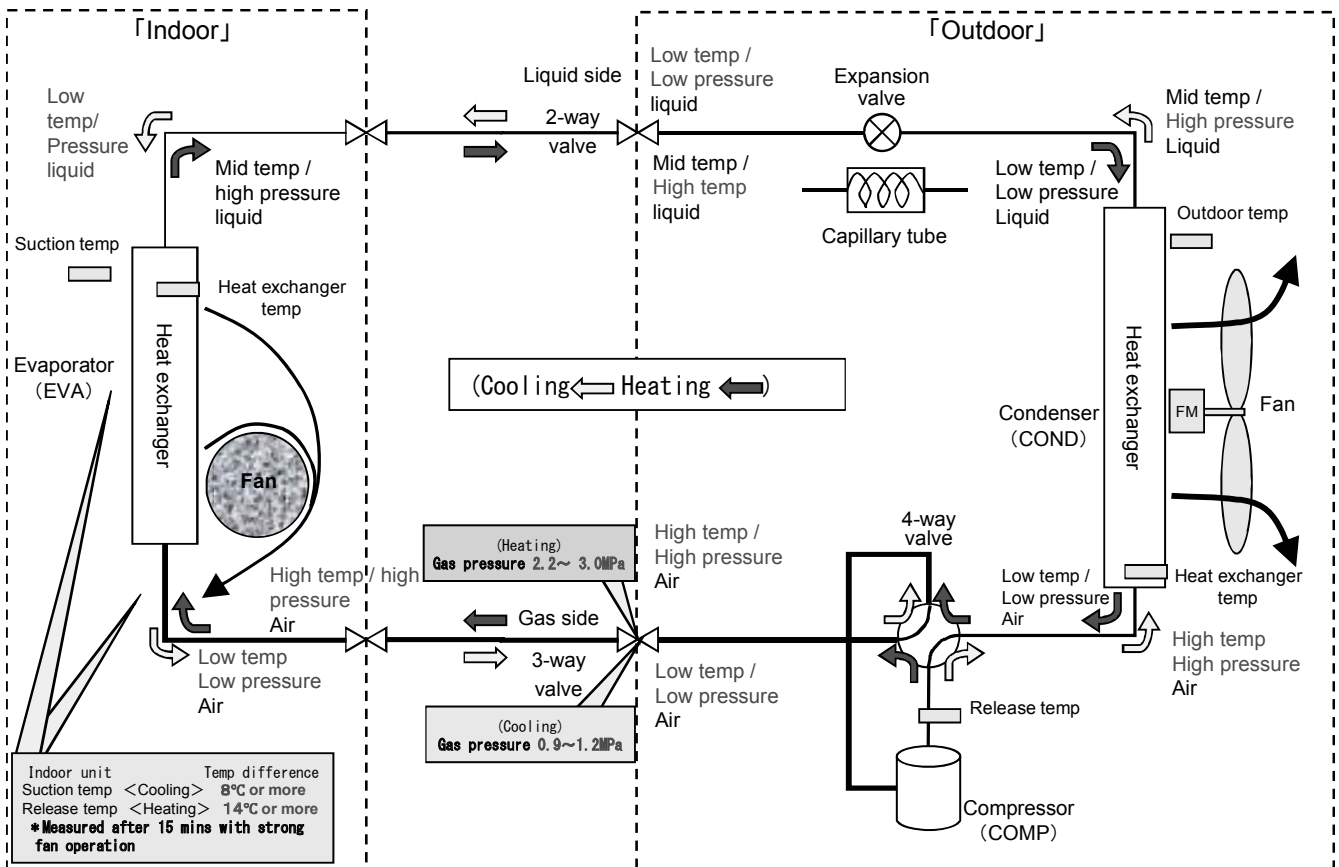

1. Measuring temperature
 - 1) Indoor unit suction temperature, release temperature, temperature difference, → Measure by thermometer
 - 2) 2-way valve pipe temperature in cooling mode is low temperature (benchmark : 5 ~ 10°C), in heating mode is medium temperature (benchmark : 25 ~ 35°C).
 - 3) 3-way valve pipe temperature in cooling mode is low temperature (benchmark : 7 ~ 15°C) in heating mode is high temperature (benchmark : 38 ~ 50°C).
2. Measuring electric current
 - Measuring electric current in operation → check by clamp meter (refer to table of technical characteristic guideline)
3. Measuring pressure
 - Measuring gas pressure → check the pressure by manifold gauge (refer to table of technical characteristic guideline)
4. Any sound from the expansion valve?
(when starting the operation and the outdoor unit is turned on, the expansion valve is re-set, check if there is any edged sound or clack sound)

13.8.3 Guidance for diagnosis of refrigerant cycle

Comparison with normal operation	Cooling mode	
	High	Low
Refrigerant pressure	Excess insertion of refrigerant	Clogged capillary, expansion valve malfunction
	Heat releasing obstruction	Clog by moisture
	Dirty condenser, attachment of impurity	Lack of refrigerant gas
	Compressor malfunction	
Operation electric current	Excess insertion of refrigerant	Lack of refrigerant gas
	Heat releasing obstruction	Compressor malfunction
	Dirty condenser, impurity	Mixture of air
		(Insufficient evacuation)
2-way valve temperature	Excess insertion of refrigerant	Clogged capillary, expansion valve malfunction
	Compressor malfunction	Lack of refrigerant gas
3-way valve temperature	Lack of refrigerant gas • Compressor malfunction	Excess insertion of refrigerant
	Clogged capillary, expansion valve malfunction	

Suction temperature & Release air temperature	Temperature difference at or less than 8°C in cooling operation • • • Causes		
	• Heat releasing obstruction	• Dirty condenser	• Attachment of impurity
	• Lack of refrigerant gas	• Excess insertion of refrigerant	
	• Mixture of air	• Mixture of moisture	
	• Clogged capillary	• Expansion valve malfunction	• Compressor malfunction

◎ Above all are based on the condition that the installation work is properly performed (no issues in indoor / outdoor pipe connections, etc.)

14. Operation Control

14.1 Basic Function

Inverter control, which is equipped with a microcomputer to determine the most suitable operating mode as time passes, automatically adjusts output power for maximum comfort always. In order to achieve the suitable operating mode, the microcomputer maintains the set temperature by measuring the temperature of the environment and performing temperature shifting. The compressor at the outdoor unit is operating following the frequency instructed by the microcomputer at the indoor unit, which judges the condition according to the internal setting temperature and intake air temperature.

14.1.1 Internal Setting Temperature

Once the operation starts, the remote control setting temperature will be taken as the base value for temperature shifting processes. These shifting processes depend on the air conditioner settings and the operation environment. The final shifted value will be used as the internal setting temperature and is updated continuously whenever the electrical power is supplied to the unit.

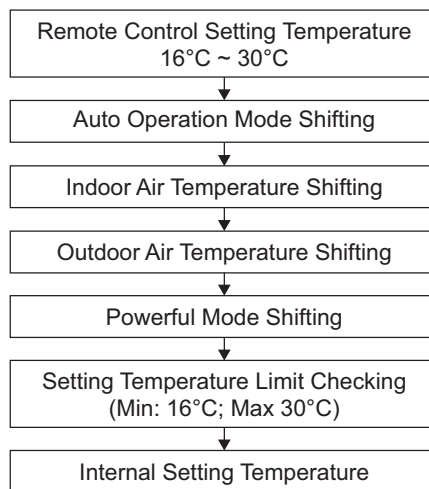

14.1.2 Cooling Operation

14.1.2.1 Thermostat Control

- Compressor is OFF when Intake Air Temperature - Internal Setting Temperature $< -1.5^{\circ}\text{C}$ continues for 3 minutes.
- Compressor is ON after waiting for 3 minutes, if the Intake Air Temperature - Internal Setting Temperature $>$ Compressor OFF point.

14.1.3 Heating Operation

14.1.3.1 Thermostat Control

- Compressor is OFF when Intake Air Temperature - Internal Setting Temperature $\geq +2.0^{\circ}\text{C}$ continues for 3 minutes.
- Compressor is ON after waiting for 3 minutes, if the Intake Air Temperature - Internal Setting Temperature $<$ Compressor OFF point.

14.1.4 Dry Operation

14.1.4.1 Thermostat control

- Compressor is OFF when Intake Air Temperature - Internal Setting Temperature $< -2.5^{\circ}\text{C}$ continues for 3 minutes.
- Compressor is ON after waiting for 3 minutes, if the Intake Air Temperature - Internal Setting Temperature $>$ Compressor OFF point.

14.1.5 Automatic Operation

- This mode can be set using remote control and the operation is decided by remote control setting temperature, remote control operation mode, indoor intake air temperature and outdoor air temperature.

- During operation mode judgment, indoor fan motor (with speed of Lo-) and outdoor fan motor are running for 30 seconds to detect the indoor intake and outdoor air temperature. The operation mode is decided based on below chart.

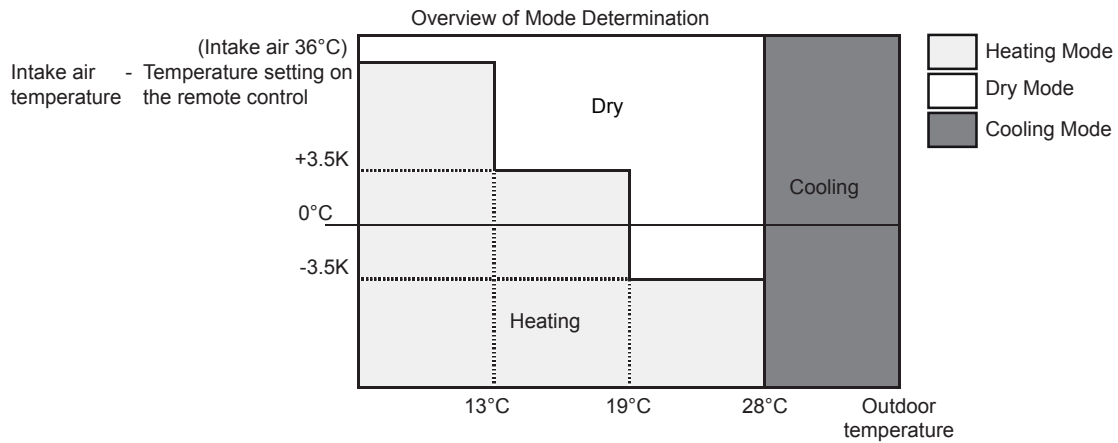

Every 30 minutes, the indoor and outdoor temperature is judged.

The Auto Operation Mode shifting will take place whenever operation mode changed from Cooling/Dry to Heating or vice versa.

14.1.6 Emergency Operation

Emergency operation can be set by pressed "Auto OFF/ON" button and operate in auto operation at the setting temperature 25°C.

14.2 Indoor Fan Motor Operation

A. Basic Rotation Speed (rpm)

i. Manual Fan Speed

[Cooling, Dry]

- Fan motor's number of rotation is determined according to remote control setting.

Remote control	O	O	O	O
Tab	Hi	Me	Me-	Lo

[Heating]

- Fan motor's number of rotation is determined according to remote control setting.

Remote control	O	O	O	O
Tab	Hi	Me	Me-	Lo

ii. Auto Fan Speed

[Cooling, Dry]

- According to room temperature and setting temperature, indoor fan speed is determined automatically.
- The indoor fan will operate according to pattern below.

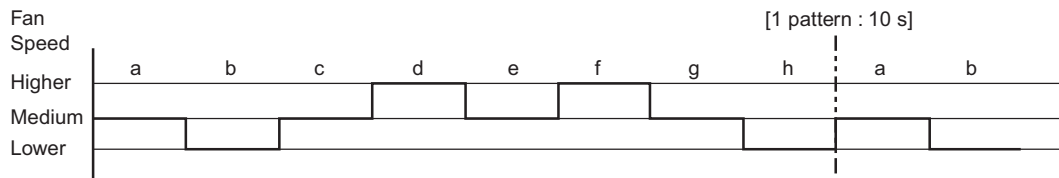

[Heating]

- According to indoor pipe temperature, automatic heating fan speed is determined as follows.

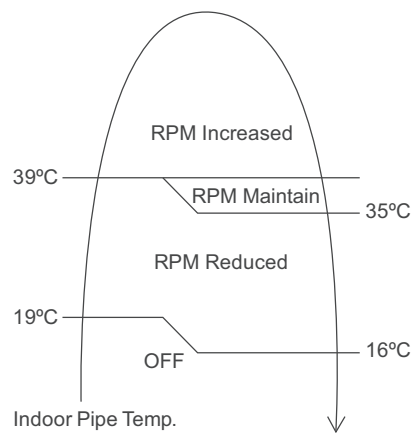

B. Feedback control

- Immediately after the fan motor started, feedback control is performed once every second.
- During fan motor on, if fan motor feedback ≥ 2550 rpm or < 50 rpm continue for 10 seconds, then fan motor error counter increase, fan motor is then stop and restart. If the fan motor counter becomes 7 times, then H19 – fan motor error is detected. Operation stops and cannot on back.

14.2.1 CS-VZ9SKE

			SSLo	SLo	Quiet	Lo-	Lo	Me-	Me	Hi	SHi	
Fan speed: Manual			450	530	430	540	600	740	880	1010	1070	
Cooling Range	Fan Speed: Auto	Normal	Outside air 35°C & Unstable							■		
			Other from the above						■ ← → ■			
		Initial airflow	Area								■	
		Airflow stable/Unstable	Area						Area ← → ■			
Dry Range	Fan Speed: Auto	Normal	Cool Dry		■ (Range ②)			■ (Range ①)				
		Initial airflow	Area							■		
		Airflow stable/Unstable	Area				Area ← → ■					
Heating range	Fan Speed: Manual			400	500	450	570	650	800	950	1110	---
	Fan Speed: Auto	Initial airflow/Unstable							■ ← → ■			
		Airflow stable	Area						Area ← → ■			
			Other than the above							■ ← → ■		
Hot Dry							■					
Blowing/Fan Operation	Fan Speed: Manual			---	---	430	---	600	740	880	1010	---
	Fan Speed: Auto			■								
Individual +8/10°C HEAT			1110									
Odor Cut Shift Only for the COOL and DRY range			Below Me and Auto: No shifting						Me and above: -90			
<ul style="list-style-type: none"> Lock detection: When the rotation speed of 2550rpm and above or below 50rpm is detected for 10 consecutive seconds during the feedback control, H19 is indicated (the TIMER indicator flashes) if normal rotation speed is not detected even after the retry is performed 7 times. Refer to the attached list of "Indoor Unit Fan Operation Status" for the operations of the indoor unit fan while the thermostat id OFF. 												

- O : Manual setting for remote controller (air discharge adjustable tap)
 ■ : Fan rotation speed
 Area : Targeted area (air discharge changes based on human position)
 ← → : Rotation speed changes based on indoor pipe temperature

※ Attention: Other than above, there are tap and rotation limit and instructed rotation speed changes based on capacity ranks and models

14.2.2 CS-VZ12SKE

			SSLo	SLo	Quiet	Lo-	Lo	Me-	Me	Hi	SHi	
Fan speed: Manual			450	590	430	590	750	850	950	1040	1100	
Cooling Range	Fan Speed: Auto	Normal	Outside air 35°C & Unstable							■		
			Other from the above					■ ← → ■				
		Initial airflow	Area								■	
		Airflow stable/Unstable	Area						Area ← → ■			
Dry Range	Fan Speed: Auto	Normal	Cool Dry		■ (Range ②)		■ (Range ①)					
		Initial airflow	Area							■		
		Airflow stable/Unstable	Area				Area ← → ■					
Heating range	Fan Speed: Manual		400	500	450	620	720	860	1000	1140	---	
	Fan Speed: Auto	Initial airflow /Unstable						■ ← → ■				
		Airflow stable	Area						Area ← → ■			
			Other than the above						■ ← → ■			
Hot Dry							■					
Blowing/Fan Operation	Fan Speed: Manual		---	---	430	---	750	850	950	1040	---	
	Fan Speed: Auto		■									
Individual +8/10°C HEAT			1140									
Odor Cut Shift Only for the COOL and DRY range			Below Me and Auto: No shifting						Me and above: -90			
<ul style="list-style-type: none"> Lock detection: When the rotation speed of 2550rpm and above or below 50rpm is detected for 10 consecutive seconds during the feedback control, H19 is indicated (the TIMER indicator flashes) if normal rotation speed is not detected even after the retry is performed 7 times. Refer to the attached list of "Indoor Unit Fan Operation Status" for the operations of the indoor unit fan while the thermostat is OFF. 												

- : Manual setting for remote controller (air discharge adjustable tap)
 ■ : Fan rotation speed
 Area : Targeted area (air discharge changes based on human position)
 ← → : Rotation speed changes based on indoor pipe temperature

※ Attention: Other than above, there are tap and rotation limit and instructed rotation speed changes based on capacity ranks and models

14.3 Outdoor Fan Motor Operation

Outdoor fan motor is operated with various fan speeds with compressor RPM. It starts when compressor starts operation and it stops 30 seconds after compressor stops operation.

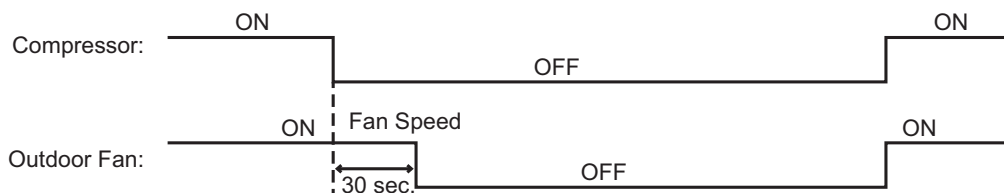

14.4 Airflow Direction

- There are two types of airflow, vertical airflow (directed by horizontal vane) and horizontal airflow (directed by vertical vanes).
- Control of airflow direction can be automatic (angles of direction is determined by operation mode, and heat exchanger temperature) and manual (angles of direction can be adjusted using remote control).

14.4.1 Vertical Airflow

		Operation state	Upper blade	Lower blade	
Heating Operation	Auto	C area	30°	35°	
		B area	Sensor, windbreak, wind address	Refer to the part of area air-conditioning	
			Normal powerful	60°	58°
	Manual	A area	10°	15°	
		Manual 1	10°	15°	
		Manual 2	15°	38°	
		Manual 3	30°	45°	
		Manual 4	45°	52°	
	Manual 5	60°	60°		
Cooling Operation	Auto	Sensor, windbreak, wind address	Refer to the part of area air-conditioning		
		Powerful	Air-flow initial	25°	30°
			Air-flow stability/instability	※ Same as cooling manual 2	
		Normal	Neuro stability	8° ~ 30°	10° ~ 35°
	Neuro instability		8° ~ 35°	10° ~ 40°	
	Manual	Manual 1 (Ceiling air-flow)	0°	3°	
		Manual 2	8°	21°	
		Manual 3	15°	38°	
Manual 4		32°	46°		
Manual 5		50°	50°		
Dry Operation	Auto	Sensor, windbreak, wind address	Refer to the part of area air-conditioning		
		Normal, powerful	※ Ceiling air-flow		
	Manual	Manual 1	0°	3°	
		Manual 2	8°	13°	
		Manual 3	17°	22°	
		Manual 4	26°	31°	
	Manual 5	35°	40°		
Blower operation	Automatic	※ Same as the normal neuro stability of cooling automation			
	Manual	※ Same as cooling manual			
Inside drying	Slight open				
Change control	Slight open				
Stop, filter cleaning, room temperature lookout waiting	Cooling position after reset				
Louver opening, in check mode	※ Same as cooling manual 5				

Determination of automatic area with heating air flow direction

Operation state		Wind direction area
Heating	Automatic demo mode	B area
	Four-way valve de-icing	A area
	In abnormality of indoor piping temperature sensor	B area
	Exceed more than 20s after stopping compressor	A area
	Exceed 180 second after completing weak operation or suction temperature area is the following low temperature area	A area
	Other than those above	Follow the following piping determination
Other than heating		A area

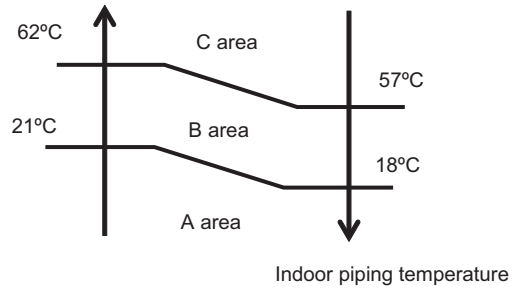
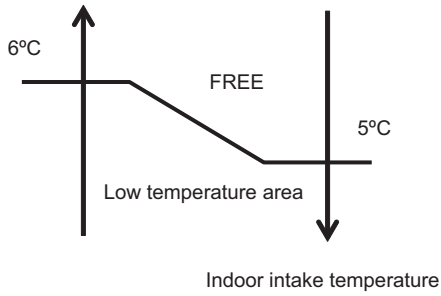



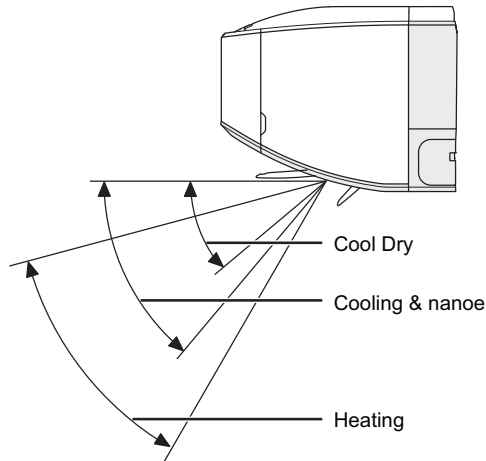



Motion range of horizontal vane (air direction control)



14.4.2 Horizontal Airflow

Automatic horizontal airflow direction can be set using remote control, the vane swings left and right within the angles as stated below.

During Manual Setting			1	2	3	4	5	6	7	
										
During Auto Setting Condition			Middle Setting (default)			Right Setting		Left Setting		
Heating Operation	Auto	C area	0°/0°							
		B area	Area	Refer to the part of area air-conditioning						
			Neuro Unbalance	0° / 0°		-25° / 25°		25° / -25°		
			Neuro balance	Powerful	0° / 0°		-30° / 30°		30° / -30°	
	Normal	0±5° / 0±5°		-25±5° / 25±5°		25±5° / -25±5°				
	A area	-40° / -40°		40° / -40°		-40° / 40°				
	Manual	Center, Non set	0° / 0°	10° / 10°	-30° / -30°	-40° / 40°	-40° / 0°	0° / -40°	40° / -40°	
Left & right setting		-40° / 50°				-30° / 0°	0° / -30°	50° / -40°		
Cooling Operation	Auto	Area	Refer to the part of area air-conditioning							
		Powerful, beginning stage	0° / 0°		-10° / 10°		10° / -10°			
		Normal, other than above	0±30° / 0±30°		-15±15° / 15±15°		15±15° / -15±15°			
	Manual	Normal	0° / 0°	10° / 10°	-20° / -20°	-30° / 30°	-30° / 0°	0° / -30°	30° / -30°	
Dry Operation	Auto	Area	Refer to the part of area air-conditioning							
		Other than above	Similar to cooling automatic normal							
	Manual	Similar to cooling manual normal								
Blower operation	Manual	Similar to cooling manual normal								
Demo mode			0±30° / 0±30°							
Inside drying			0°/0°							
Stop, stop de-ice										
In weak heating operation										

* B area: Left & right wind direction (twin independent configuration spec)

* The front position standard: Inward + outward - (Left blade/right blade)

14.5 Quiet Operation

- Purpose
 - To provide quiet operation compare to normal operation.
 - Quiet operation can be operate with Auto, Cooling, Heating, Dry and nanoe.
- Control condition
 - Quiet operation start condition
 - When “QUIET”  button at remote control is pressed.
 - “QUIET” shown in LCD of remote control.

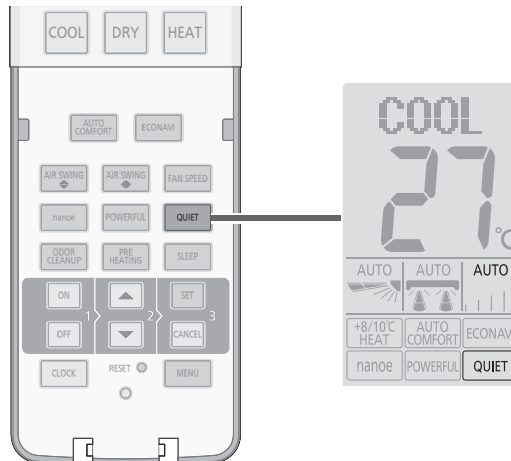

- Quiet operation stop condition
 - When one of the following conditions is satisfied, quiet operation stops:
 - QUIET button is pressed.
 - Stop by OFF/ON button.
 - FAN SPEED button is pressed.
 - ECONAVI button is pressed.
 - AUTO COMFORT button is pressed.
 - POWERFUL button is pressed.
 - When fan speed is changed, fan speed follows the setting change.
 - When operation mode is changed, resume previous operation setting.
 - During quiet operation, if timer “ON” activates, quiet operation maintains.

14.6 Powerful Mode Operation

- During cooling or heating operation by pressing the “Powerful” button for a certain period of time, it will blow out the strong cold air or strong heat air.
- When the powerful mode is selected, the internal setting temperature will shift lower up to 2°C (for Cooling/Dry) or higher up to 2°C (for Heating) than remote control setting temperature for 20 minutes to achieve the setting temperature quickly.
- Maximum operation for Powerful (Cooling/Dry) is 60 minutes to achieve the setting temperature quickly and resume normal operation when room temperature reaches or less than 16°C.
- Maximum operation for Powerful (Heating) is 60 minutes to achieve the setting temperature quickly and resume normal operation when room temperature reaches or more than 30°C.
- Fan speed will be set as “Auto” and ECONAVI operation will be canceled.
 - Powerful operation stop condition
 - When one of the following conditions is satisfied, powerful operation stops:
 - QUIET button is pressed.
 - Stop by OFF/ON button.
 - OFF Timer activates.
 - POWERFUL button is pressed again.
 - Powerful operation continues for 60 minutes.

14.7 Timer Control

- There are 2 sets of ON and OFF timer available to turn the unit ON or OFF at different preset time.
- If more than one timer had been set, the upcoming timer will be displayed and will activate in sequence.

14.7.1 ON Timer Control

- ON timer 1 and ON timer 2 can be set using remote control, the unit with timer set will start operate earlier than the setting time.
This is to provide a comfortable environment when reaching the set ON time.
- 70 minutes before the set time, indoor (at fan speed of Lo-) and outdoor fan motor start operate for 30 seconds to determine the indoor intake air temperature and outdoor air temperature in order to judge the operation starting time.
- From the above judgment, the decided operation will start operate earlier than the set time as shown below.

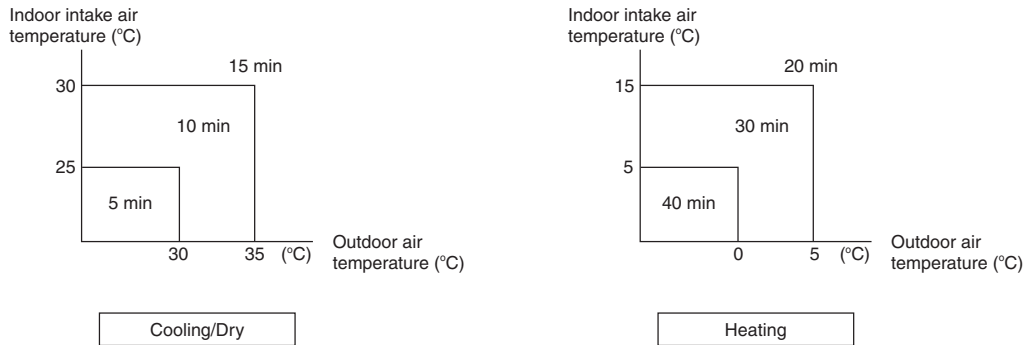

14.7.2 OFF Timer Control

OFF timer 1 and OFF timer 2 can be set using remote control, the unit with timer set will stop operate at set time.

14.7.3 Sleep Timer

- Sleep operation is performed according to the delay OFF time (0.5, 1, 2, 3, 5, 7, or 9 hour) and provide comfortable environment by shifting set temperature.
- This will automatically adjust the temperature to prevent your body from being cooled down or warmed up too much.

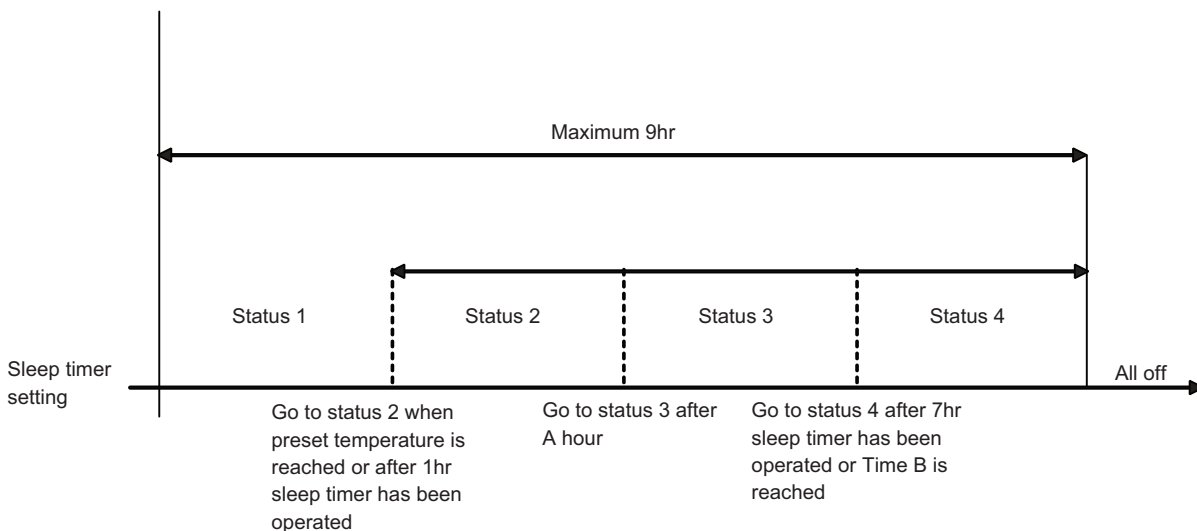

	Heating	Cooling, Dry
A	2hr	3hr
B	*5am	*4am

* According to remote control clock

- Remaining time appear on the remote control displays for the remaining time every hour. When the time is up the remaining time display will disappear.
- If change the remote control setting temperature during the sleep operation, you can correct the set temperature during the next sleep operation (up to $\pm 1^{\circ}\text{C}$ by pressing “date and time” button (5 seconds or more).
- During cooling operation and set to the sleep mode, it will make the cooling and dehumidifying operation.

Temperature Shift

		Status 1	Status 2	Status 3	Status 4
Set temperature ($^{\circ}\text{C}$)	Cooling / Dry	0	+1	+1	+1
	Heating	0	-1	-1	-1

- Sleep operation stop condition
 - Reached delay time.
 - Pressed sleep button to cancel.
 - Unit is OFF.







14.8 Auto Restart Control

- When the power supply is cut off during the operation of air conditioner, the compressor will re-operate within three to four minutes (various period of protection control is programmed) after power supply resumes.
- The type control is not applicable during ON/OFF Timer setting, Sleep Timer Setting or when there is an abnormality.
- When the power supply resumes, the vertical louver does not closed. Press the “STOP” button if want close the vertical louver.

14.9 Menu Function

To change setting according to living environment.

- 8 options are available in Menu button.

Display Items	Purpose	Button
Center	To set Indoor unit installation position (CENTER  → LEFT  → RIGHT )	 (Pressed and released)
Auto-off	To set Auto Off operation. (Human activity sensor)	
Brighter LED	Change the brightness of the remote controller.	
Contrast	Change the contrast of the remote controller.	
Back light	Change the brightness of the back light of the remote controller.	
Remote Control Code Setting	To change remote control code (A, B, C and D).	 (Pressed until 10 seconds)
Sunlight Sensor	To set sunlight sensor intensity.	
Back light	To change back light timer of remote control (Standard or Long).	 (Pressed until 20 seconds)

To set functions at MENU button.

- This functions can be set by pressing MENU  button at remote controller for 1 times press, 10 seconds and 20 seconds.





- Press set ARROW  button to select functions.

- Press SET  button to confirm.

- Press CANCEL  button to cancel Menu functions.

14.10 Info Function

- Purpose
 - To check the energy charging level.
 - To check the diagnosis code for malfunction.
- To check the energy charging level.
 - Air conditioner must be operate in heating mode.
 - Press Info  button on the remote controller to check energy charging level.
 - Display will be indicate of the storage of heat that can be used in the non-stop defrost operation.
 - Energy charging level (0~4).
 - Energy charging level will be displayed on the remote controller display for 4 seconds then it will return to the original display.
 - When press the info button in any operation except heating, remote control will display as “_”.
- To check the diagnosis code for malfunction.
 - Once abnormality has occurred during operation, the unit will stop its operation and Timer LED blinks.
 - Press Info  button on the remote controller to check diagnosis code.
- “beep, beep, beep, beep” sound can be heard and display "diagnosis" then show alphanumeric (H□□ or F□□).
- Diagnosis code will be displayed on the remote controller display for 4 seconds then it will return to the original display.

14.11 Indication Panel

LED	POWER	TIMER	+8/10°C	nanoe/ODOR CLEANUP	ECONAVI
Color	Green	Orange	Green	Blue	Green
Light ON	Operation ON	Timer Setting ON	+8/10°C HEAT ON	nanoe / ODOR CLEANUP ON	ECONAVI ON
Light OFF	Operation OFF	Timer Setting OFF	+8/10°C HEAT OFF	nanoe / ODOR CLEANUP OFF	ECONAVI OFF

Note:

- If Operating LED is blinking, the possible operation of the unit are HOT Start, during Deice operation, operation mode judgement, or ON timer sampling.
- If Timer LED is blinking, there is an abnormality operation occurs.

14.12 nanoe Operation

- This operation provides moisturizing effect on the skin or hair due to the generation of (fine particle ions wrapped in water), to provide a deodorant and sterilization effect.
- It is depends on the season, ambient environment (temperature and humidity), hours of use, human. This preserves user's skin's moisture, coherency feeling of hair.
- This operation also for reduces the smell in the room, smell that sticks on curtains (smell of cigarettes and foods) and constrains propagations of mold and bacteria. The deodorization effect depends on the ambient environment (temperature and humidity) hours of use, type of smells and fabrics.
- The “nanoe” generates ions using the air in the room.
- nanoe operation can be set together with cooling, heating and dry operation.
- If press the air-purification button in nanoe operation, the air-purification operation can be operate.
- If press the nanoe button during operation stop, the nanoe operation can operate nanoe solely.
- Recommend using nanoe in the below condition:
Indoor temperature: about 5~35°C (focused temperature: more than about 2°C).
Humidity: about 30~85%
- nanoe ON/OFF condition

Condition		nanoe operation	
1	Demo Mode	OFF	
	Cooling operation check		
	nanoe abnormality		
	nanoe re-start stanby		
2	Out of mistification area	OFF	
3	nanoe check	After checking nanoe more than 2 minute	OFF
		Other than above	ON
4	Cleaning indoor unit nanoe operation fan mode	ON	
5	Remocon setting nanoe OFF	OFF	
6	Filter cleaning	OFF	
7	Inside cleaning	Heating or after heating fan	OFF
		Other than above	ON
8	Thermo OFF	Odor cutting	OFF
		Heating operation	
9	Indoor fan motor 440 RPM	OFF	
10	Operation stop	OFF	
11	Other than above	ON	

14.13 ODOR CLEANUP

- Purpose
 - This operation is to release odor from indoor unit.
- Control condition (During Stand by mode)
 - Press ODOR CLEANUP button for 3 seconds or more.
 - The operation activates for 20 minutes and resume to the presetting operation automatically.
 - The unit will be stop after 20 minutes of ODOR CLEANUP function. (Blast --> Heating --> Blast).
 - Air flow amount is adjusted automatically and the air flow direction is upward.

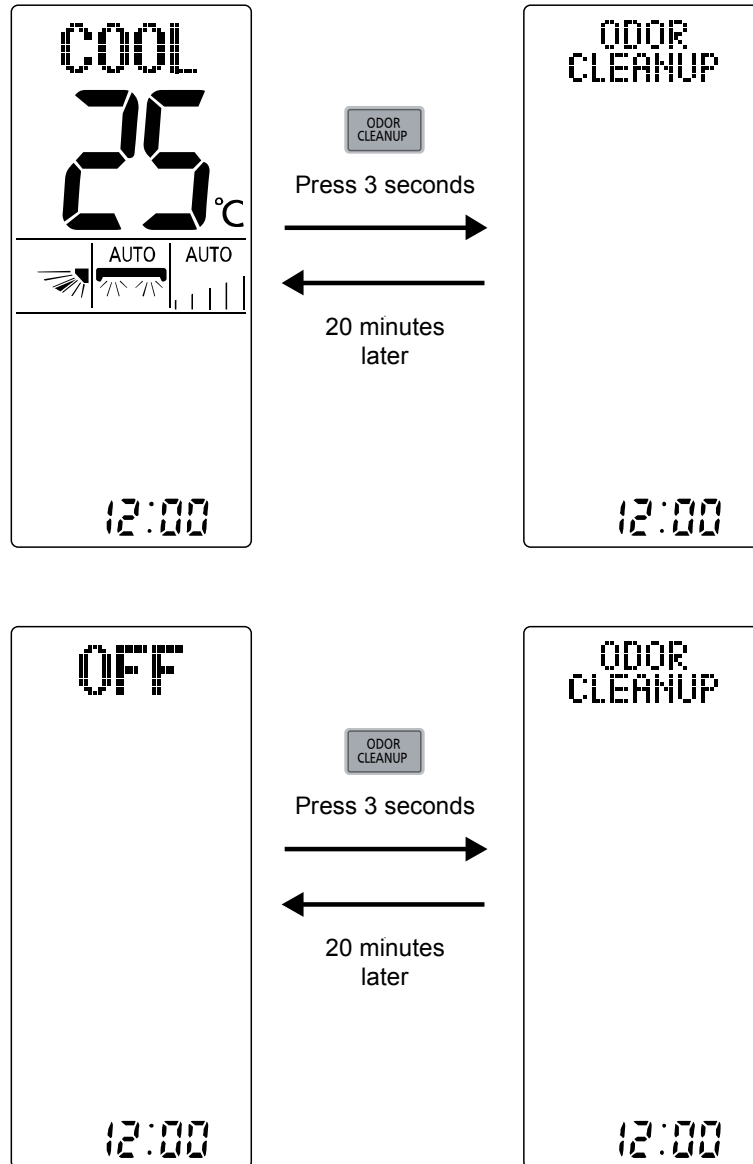

* No odor cleanup when stopped in half way.

- OFF timer: ODOR CLEANUP continues display and the operation stopped after odor removal end.
- SLEEP timer: ODOR CLEANUP immediately stop and OFF "ODOR CLEANUP" display.
- Note:
 - When pressing "ODOR CLEANUP" for 3 seconds during operation, the unit gets back to normal operation after 20 minutes of ODOR CLEANUP operation.
 - During odor clean operation, please open windows to circulate the room air because the room temperature and humidity will rise followed by odor inside the room.
 - If the odor persists after the odor cleanup operation, please consult service dealers for unit washing and service.

14.14 +8/10°C Operation

- +8/10°C operation provides heating at low setting temperature in unoccupied houses during winter for the purpose of protecting equipments or housing appliances which may be destroyed by the extreme cold weather.
- This operation can be ON by pressing the +8/10°C button on the remote control.
- Two temperature settings are available, which are;
 - 8°C (Pressing TEMP down button at the remote control)
 - 10°C (Pressing TEMP up button at the remote control)

During the operation or standby mode:

- The indoor fan speed will remain at Hi fan tap all the time included deice process.
- Powerful operation, Quiet operation, Econavi operation and Fan Speed selection are disabled.
- Cold draft prevention control is disabled.
- The vane direction can be set using remote controller.
- In default setting, it will operate the nanoe at the same time.
- Control condition;

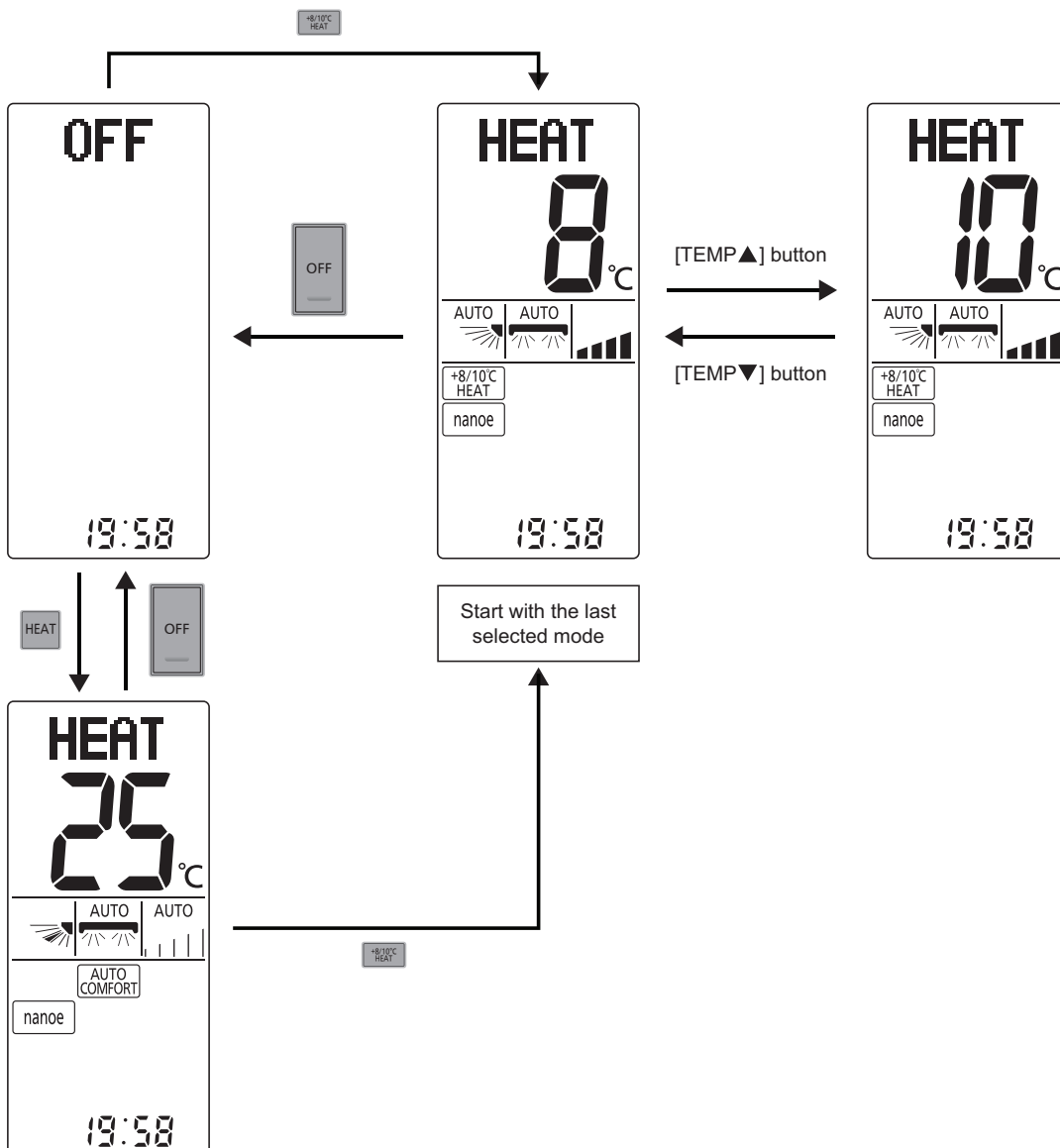

NOTE:

+8/10°C HEAT set temperature follows previously fixed set temperature (+8°C or +10°C). But after battery reset, (default condition) set temperature always start with +8°C.

⚠ Caution

If the indoor temperature constantly is less than 0°C (Door, windows not close properly), the error code F11 may occur. This is because in open area, the indoor pipe sensor will misjudge operation condition and will give error code.

14.15 Pre Heating Operation

- Pre Heating operation learn and memorised everyday switch "ON" time of heating and pre heating to blow heat wind as soon pressed the heating button.
- Before setting, please make sure that the current time is correct.
- If start operation in heating or pre-heating, the air conditioner could not blow hot air immediately because it is not heat enough to blow hot air. (operation lamp will blink)

* Recommend: Clear the setting when not use the air conditioner in for a long time period.

- The initial condition of the charging operation

Indoor unit learns every-day switch "ON" time

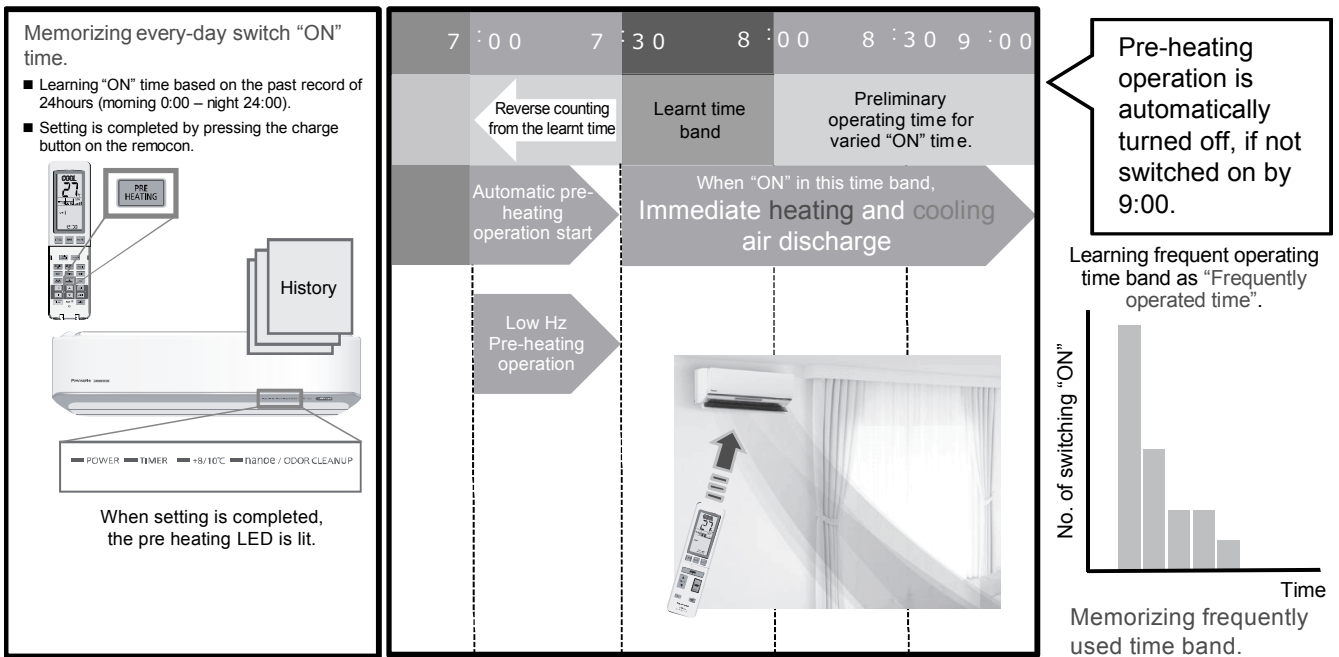

Heating: The room temperature should be less than 18°C and the outdoor temperature should be less than 10°C and previous operation is heating operation.

- When relative temperature is high, pre-heating operation might be stopped for dew prevention.

Note:

- * The air conditioner will learn and memorize the time zone that you used frequently and perform the pre-heating operation.
- * When it is in pre-heating operation, the operation lamp will not light up.
- * Only when the previous operation is a heating, it will perform the pre-heating operation.
- * If you do not press the heating button, it will perform the pre-heating operation for 60 min and finish it.

14.16 AUTO COMFORT and ECONAVI Operation

- Area of human availability, activity level and absent is judged based on pulses by using infrared sensor. The internal setting temperature shift, fan speed, horizontal and vertical airflow direction are adjusted in order to provide comfort environment while maintain the energy saving level.
- AUTO COMFORT start condition:
 - When AUTO COMFORT button is pressed.
- AUTO COMFORT stop conditions:
 - When AUTO COMFORT button is pressed again.
 - When unit is OFF by OFF button.
 - When unit is OFF when OFF TIMER activates.
 - When unit is OFF by AUTO OFF/ON button at indoor unit.
 - When POWERFUL, QUIET and ECONAVI operation activates.
 - When ◀▶ button is pressed.
 - When FAN SPEED button is pressed.
- ECONAVI start condition:
 - When ECONAVI button is pressed.
- ECONAVI stop conditions:
 - When ECONAVI button is pressed again.
 - When unit is OFF by OFF button.
 - When unit is OFF when OFF TIMER activates.
 - When unit is OFF by AUTO OFF/ON button at indoor unit.
 - When POWERFUL, QUIET and AUTO COMFORT operation selected.
 - When FAN SPEED button is pressed.
 - When Vertical louver button is pressed.

14.16.1 Human Activity Sensor

- Area of human availability, activity level and absent is judged based on pulses by using infrared sensor. The internal setting temperature shift, fan speed and horizontal airflow direction are adjusted in order to provide comfort environment while maintain the energy saving level.
- Human activity judgment is as following:

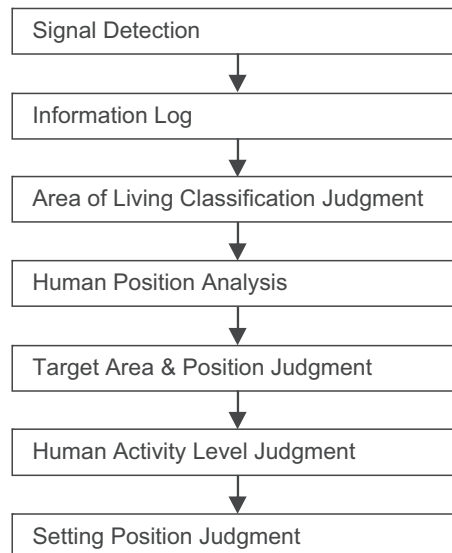

14.16.1.1 Signal Detection

Sensor: 2 unit

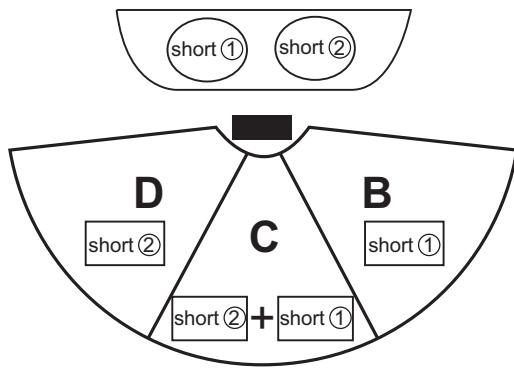

Area	B	C	D
Short distance	①	O	O
	②		O

Estimated flow of human position

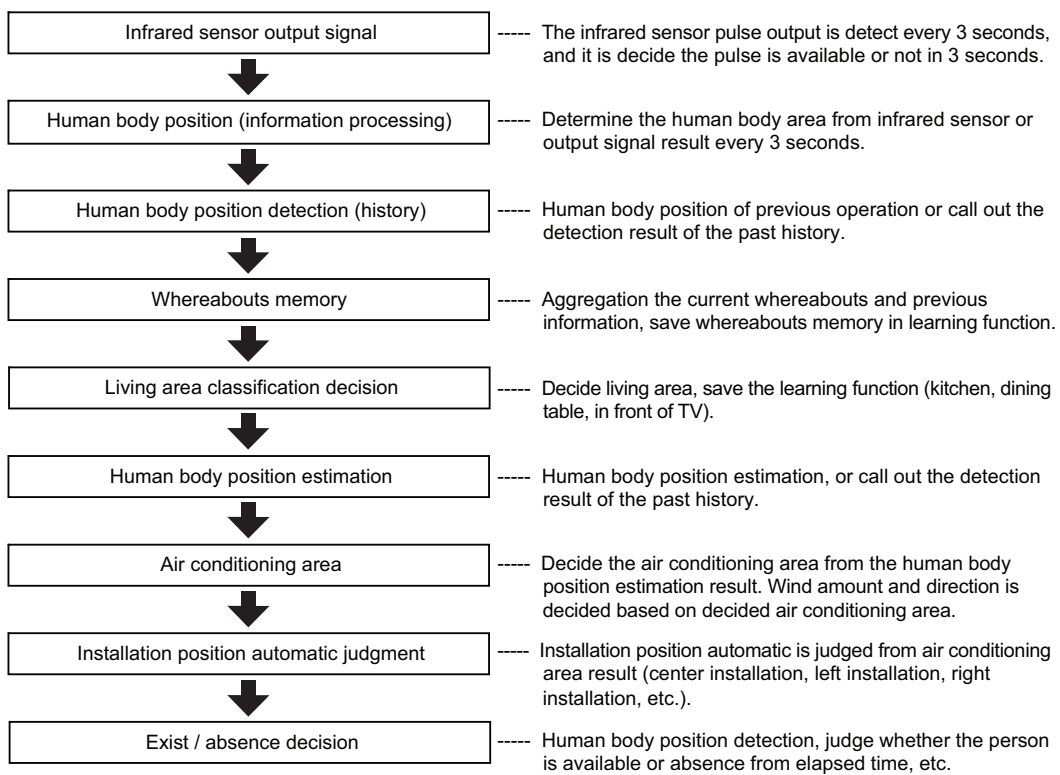

14.16.1.2 Information Log

- The signal from Infrared sensor will be log to human activity database for further analysis.

14.16.1.3 Human Position Analysis

- According to Area of Living, frequency of activity, the system will analyze the human position away from the indoor unit.

14.16.1.4 Human Activity Level Judgment

- Human Activity Level is judged based on the frequency of pulses detected by the infrared sensor within a timeframe. The activity level will be categorized into High, Normal or Low level.
- When a pulse is detected within this timeframe, the status of human presence is judge.
- When there is no signal detection continues for 30~60 minutes, the result of activity amount status is "Low" consecutively for 5 cycles the status of human absence is judged.

14.16.1.5 Determination of Presence or Absence

- Human presence status shall be determined based on the human presence status of each area.
- When all area has been detected absent for more than 120 minutes then it will judge as absence.

14.16.1.6 Area of Living Classification Judgment

- The system is able to judge area of living according to human activity database, classified as following:
 - Living Area - In front of television, dining table, etc.
 - Walkway - Human detection is relatively less.
 - Non-Living Area - Near windows, wall, etc.

14.16.1.7 Target Area and Position Judgment

- By default, the system will judge the indoor unit installation position according to human activities and will reset the louver center position:
 - Non-Living Area at Position A - Indoor unit is installed at left side of the room, louver center position set to right side.
 - Non-Living Area at Position C - Indoor unit is installed at right side of the room, louver center position set to left side.
 - Other than above - Indoor unit is installed at center of the room, louver position set to center.
- Every 4 hours, the Target Area and Position Judgment will restart.
- If the indoor unit installation position is set by remote control, the above judgement will be ignored.

14.16.2 Setting Temperature and Fan Speed Shift

- Cooling Dual Sensor

ECONAVI ; Detecting human presence and activity, the unit controls room temperature to save energy.

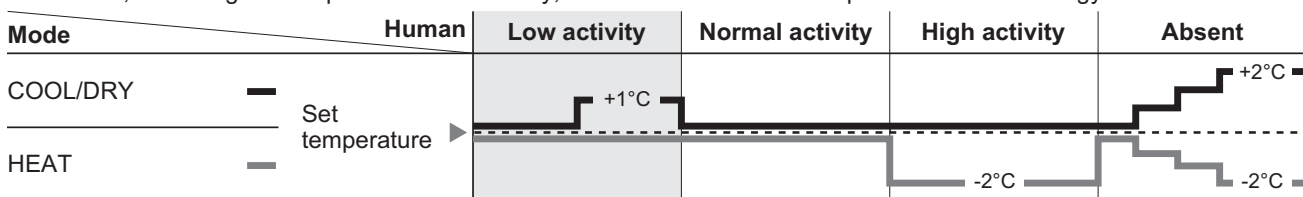











14.16.3 Air Direction Control

Fan motor, horizontal vane, vertical vane are to control and adjust the discharge air amount and direction.

14.16.3.1 Image of Air Flow Control

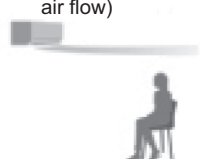
When sensor is set:

	Sensor directs the air to humans	To avoid direct air flow	Direct air flow
Cooling	<p>Reaching close to set temperature</p>  <p>When reached set temperature (Cooling shower air flow)</p> 	<p>(Cooling shower air flow)</p> 	
Heating	<p>Reaching close to set temperature</p>  <p>When reached set temperature</p>  <p>(Heating near to floor)</p>		
Dry	<p>Reaching close to set temperature</p>  <p>When reached set temperature (Cooling shower air flow)</p> 	<p>(Cooling shower air flow)</p> 	

※ When "Powerful" is set.

- Cooling or heating: Strong air flow at beginning, air discharge change after that.

When sensor is not set:

	Auto mode air conditions whole room	When "Powerful" or "More" is set, is cools (heats) the entire room quickly
Cooling		<p>When hot ► When cooling</p>
Heating	<p>When cool ► When heated</p>	<p>When cool ► When heated</p>
Dry		(cannot be set)

14.16.3.2 Human Activity Sensor Check Mode

1 Conditions to start the mode

The infrared sensor check mode starts when all of the following conditions are fulfilled / satisfied:

- a. The infrared sensor error is not being detected.
- b. Not in Demo mode.
- c. An error of Error Level 20 or higher is not present.
- d. The signal for infrared sensor check is received.

2 Conditions to end the mode

The infrared sensor check mode ends when any of the following conditions is met:

- a. A signal other than the signal for infrared sensor check is received; or the Auto OFF/ON button is pressed → The signal received is followed.
- b. 5 minutes have elapsed since the signal for infrared sensor check was received → The mode is stopped.
- c. The infrared sensor error is confirmed → The mode is stopped.
- d. An error of Error Level 20 or higher has occurred → Follow the processing of each error.

3 Descriptions of the mode

Every time the signal for infrared sensor check is received, the fixed detection is performed at a different human activity sensor angle. The result is displayed on LED every 3 seconds.

Operation mode	OFF (Cleaning is also stopped)	
Panel	Ordinary operating position (It opens even if the mode signal received is "OFF")	
Human activity sensor STM	Every time the signal for infrared sensor check is received, the position is shifted in the sequence of "Front → Left → Right → Front ..." It starts operation from the front position when the check mode starts.	
	Front	Direction towards detection of middle area
	Left	Direction towards detection of left area
	Right	Direction towards detection of right area
LED	[TIMER] LED	Sensor responded: ON Sensor not responded: OFF
	[ECONAVI] LED	The status in which the detection is not allowed *: OFF The status in which the detection is allowed: ON
	Other LEDs	OFF
Other parts	Follow the case of OFF mode	

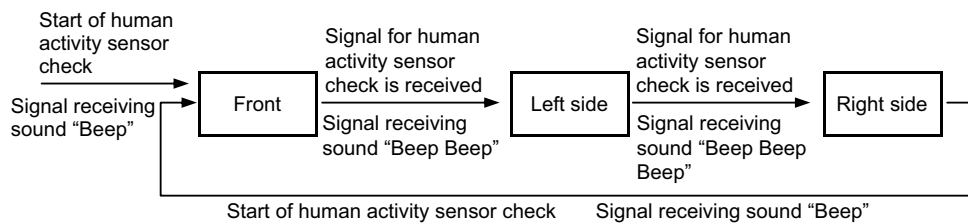

※ Conditions in which detection is not allowed

- For 65 seconds after the infrared sensor is powered ON.
- While the human detection sensor STM is in operation and for 10 seconds after the human activity sensor STM turns off.

※ Operation command by HA and ON timer is not valid during check mode.
(OFF mode continues even after the check mode stops at the expiry time.)

14.16.4 Sunlight Sensor

- During ECONAVI operation, the sunlight sensor detects sunlight intensity coming through windows and differentiates between sunny and cloudy or night to further optimize energy saving by adjusting the temperature.
- Sunlight judgment is as following.

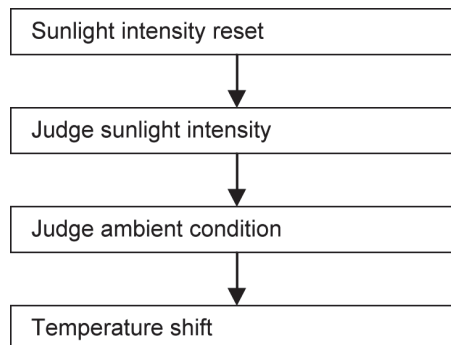

14.16.4.1 Sunlight Intensity Reset

- The sunlight intensity will to reset to zero (no sunlight condition) when
 - Each time ECONAVI is activated.
 - Setting temperature is changed.
 - Operation mode is changed (exception interchanging COOL ↔ Dry).
 - Open the Front Panel (Front Panel switch open).

14.16.4.2 Judge Sunlight Intensity

- Based on sunlight sensor output voltage, the sunlight intensity value will be computed and logged to sunlight intensity database.
- The sunlight sensor sensitivity could be adjusted:

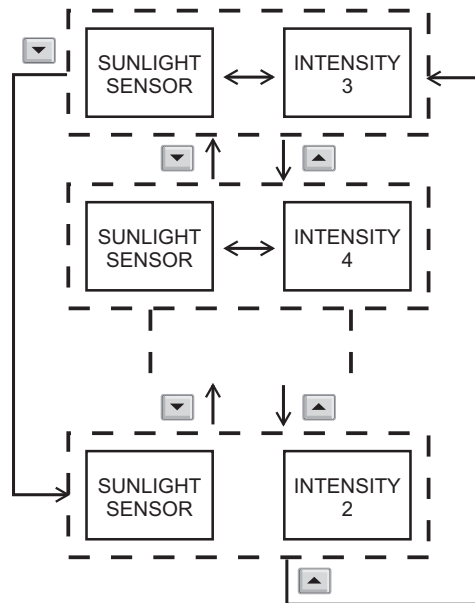

14.16.4.3 Judge Ambient Condition

- According to sunlight intensity over a period of time, the system will analyze the ambient condition is sunny, cloudy or night.

14.16.4.4 Temperature Shift

ECONAVI ; Detecting sunlight intensity, the unit adjust temperature to save energy.

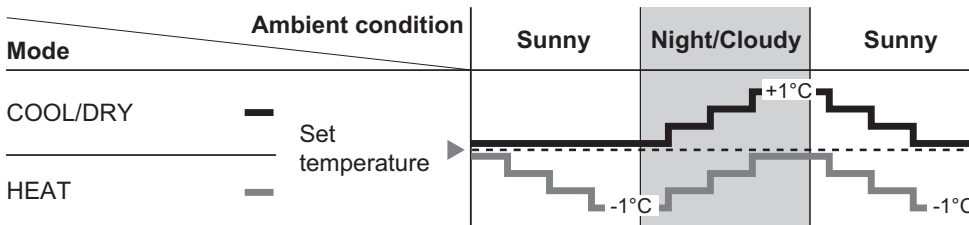

- In a room without window or with thick curtain, the sunlight sensor will judge as cloudy/night.

14.16.4.5 Sunlight Sensor Check Mode

- Operation details (to check, press ECONAVI button for 10 sec).
 - The sunlight sensor check mode will be operated for 5 minutes.
 - During check mode, the ON and OFF timer will be memorized but its operation will be ignored.
 - During check mode, if the sunlight sensor check code is retransmitted, the 5 minutes counter will be reset.
 - During check mode, if the sunlight sensor detected the sunlight intensity value above the minimum level, the ECONAVI indicator turns ON. Else if the sunlight sensor detected the sunlight intensity value below the minimum level, the ECONAVI indicator is OFF.
- To disable sunlight sensor check mode
 - After check mode is ended (5 minutes counter elapsed), press AUTO OFF/ON button at indoor unit.
 - If the sunlight sensor detected the sunlight intensity is at an abnormal range, the check mode will be ended. Please check for error code.

14.16.4.6 Sunlight Sensor Abnormality

- Abnormality detection:
 - When ECONAVI is ON, if the sunlight intensity value below the minimum level continuously for 24 hours, the sunlight sensor disconnection error counter will increase by 1 time. If the ECONAVI is OFF, the 24 hours timer will be reset, but the sunlight sensor disconnection error counter will not be reset.
- Error Code Judgment
 - When the sunlight sensor disconnection error counter reached 15 times, H70 occurred.
 - No TIMER indicator or ECONAVI indicator blink.
- When error code happened, the unit is able to operate without the sunlight sensor.

15. Protection Control

15.1 Protection Control for All Operations

15.1.1 Restart Control (Time Delay Safety Control)

- The Compressor will not turn on within 3 minutes from the moment operation stops, although the unit is turned on again by pressing OFF/ON button at remote control within this period.
- This control is not applicable if the power supply is cut off and on again.
- This phenomenon is to balance the pressure inside the refrigerant cycle.

15.1.2 Total Running Current

- 1 When the outdoor unit total running current (AC) exceeds X value, the frequency instructed for compressor operation will be decreased.
- 2 If the running current does not exceed X value for 10 seconds, the frequency instructed will be increased.
- 3 However, if total outdoor unit running current exceeds Y value, compressor will be stopped immediately for 3 minutes.

Model	VZ9SKE		VZ12SKE	
Hz	50		50	
Operation Mode	X (A)	Y (A)	X (A)	Y (A)
Cooling (A)	6.93	17.2	7.99	17.2
Cooling (B)	5.65	17.2	6.63	17.2
Cooling (C)	4.53	17.2	5.45	17.2
Heating	14.17	17.2	14.17	17.2

- 4 The first 30 minutes of cooling operation, (A) will be applied.

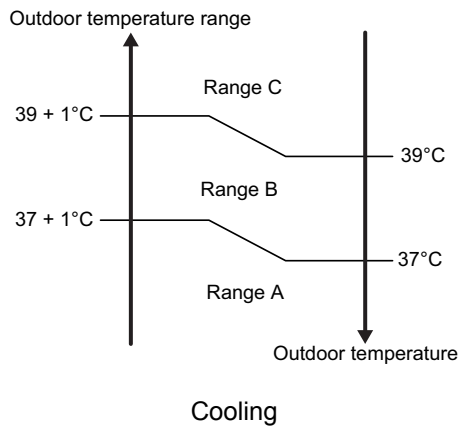

Maximum Current Limit

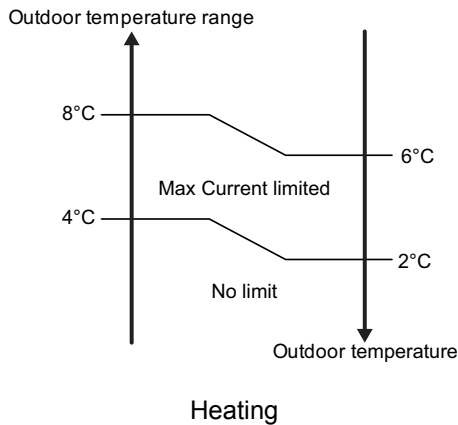

15.1.3 IPM (Power Transistor) Prevention Control

- Overheating Prevention Control
 - 1 When the IPM temperature rises to 120°C, compressor operation will stop immediately.
 - 2 Compressor operation restarts after 3 minutes the temperature decreases to 110°C.
 - 3 If this condition repeats continuously 4 times within 30 minutes, timer LED will be blinking (“F96” is indicated).
- DC Peak Current Control
 - 1 When electric current to IPM exceeds set value of 20 A, the compressor will stop operate. Then, operation will restart after 3 minutes.
 - 2 If the set value is exceeded again more than 30 seconds after the compressor starts, the operation will restart after 1 minute.
 - 3 If the set value exceeded again within 30 seconds after the compressor starts, the operation will restart after 1 minute. If this condition repeats continuously for 7 times, all indoor and outdoor relays will be cut off, timer LED will be blinking (“F99” is indicated).

15.1.4 Compressor Overheating Prevention Control

- Instructed frequency for compressor operation will be regulated by compressor discharge temperature. The changes of frequency are as below.
- If compressor discharge temperature exceeds 107°C, compressor will be stopped, occurs 4 times per 20 minutes, timer LED will be blinking. (“F97” is indicated.)

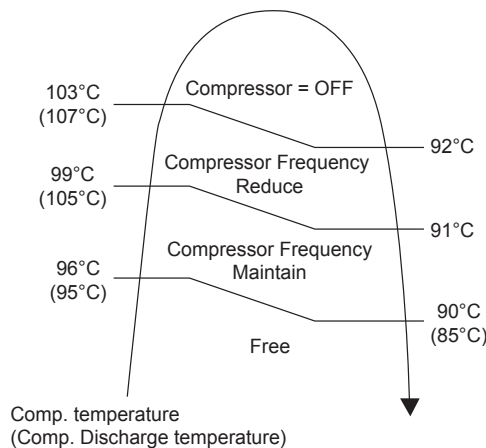

15.1.5 Low Pressure Prevention Control (Gas Leakage Detection)

- Control start conditions
 - For 5 minutes, the compressor continuously operates and outdoor total current is between 0.75A and 0.95A.
 - During Cooling and Dry operations:
Indoor suction temperature - indoor piping temperature is below 4°C.
 - During Heating operations :
Indoor piping temperature - indoor suction is under 5°C.
- Control contents
 - Compressor stops (and restart after 3 minutes).
 - If the conditions above happen 2 times within 20 minutes, the unit will:
 - Stop operation
 - Timer LED blinks and “F91” indicated.

15.1.6 Low Frequency Protection Control 1

- When the compressor operate at frequency lower than 24 Hz continued for 240 minutes, the operation frequency will be changed to 23 Hz for 2 minutes.

15.1.7 Low Frequency Protection Control 2

- When all the below conditions comply, the compressor frequency will change to lower frequency.

Temperature, T, for:	Cooling/Dry	Heating
Indoor intake air (°C)	T < 14 or T ≥ 30	T < 14 or T ≥ 28
Outdoor air (°C)	T < 13 or T ≥ 38	T < 4 or T ≥ 24
Indoor heat exchanger (°C)	T < 30	T ≥ 0

15.1.8 4-Way Valve Operation Detection Control (Switching Abnormality between Cooling and Heating)

- When indoor heat exchanger exceeds 45°C (Cooling operation) or 0°C (Heating and Deice operation) in 4 minutes or 3 minutes (Deice operation) after compressor start, compressor will stopped.
- If above condition occurs 4 times per 40 minutes (non-stop heating deice operation), timer LED blinks "F11" indicated.

15.2 Protection Control for Cooling and Dry Operation

15.2.1 Outdoor Air Temperature Control

- The compressor operating frequency is regulated in accordance to the outdoor air temperature as shown in the diagram below.
- This control will begin 1 minute after the compressor starts.
- Compressor frequency will adjust base on outdoor air temperature.

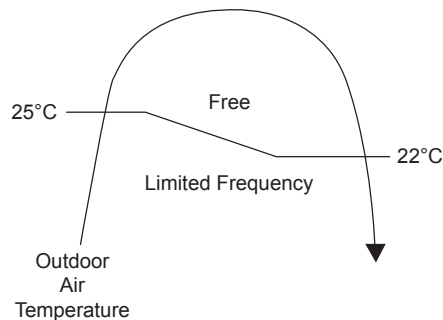

15.2.2 Cooling Overload Control

- Detects the Outdoor pipe temperature and carry out below restriction/limitation (Limit the compressor Operation frequency).
- The compressor stop if outdoor pipe temperature exceeds 61°C.
- If the compressor stops 4 times in 20 minutes, Timer LED blinking (F95 indicated: outdoor high pressure rise protection).

15.2.3 Freeze Prevention Control 1

- When indoor heat exchanger temperature is lower than 0°C continuously for 6 minutes, compressor will stop operating.
- Compressor will resume its operation 3 minutes after the indoor heat exchanger is higher than 5°C.
- At the same time, indoor fan speed will be higher than during its normal operation.
- If indoor heat exchanger temperature is higher than 5°C for 5 minutes, the fan speed will return to its normal operation.

15.2.4 Freeze Prevention Control 2

- Control start conditions
 - During Cooling operation and dry operation
 - During thermo OFF condition, indoor intake temperature is less than 10°C or
 - Compressor stops for freeze prevention control
 - Either one of the conditions above occurs 5 times in 60 minutes.
- Control contents
 - Operation stops.
 - Timer LED blinks and "H99" indicated.

15.2.5 Dew Prevention Control 1

- To prevent dew formation at indoor unit discharge area.
- This control will be activated if:
 - Outdoor air temperature and Indoor pipe temperature judgment by microcontroller is fulfilled.
 - When Cooling or Dry mode is operated more than 20 minutes or more.
- This control stopped if:
 - Compressor stopped.
 - Remote control setting changed (fan speed / temperature).
 - Outdoor air temperature and indoor intake temperature changed.
- Fan speed will be adjusted accordingly in this control.

15.2.6 Odor Cut Control

- To reduce the odor released from the air discharge vent.
 - Start Condition
 - AUTO FAN Speed is selected during COOL or DRY operation.
 - During freeze prevention control and timer preliminary operation, this control is not applicable.
 - Control content
 - Depends on compressor conditions:
 1. Compressor OFF → Compressor ON.
The indoor unit fan stops temporarily and then starts to blow at minimum airflow for 40 seconds.
 2. Compressor ON → Compressor OFF.
The indoor unit fan stops for 90 seconds and then blows at minimum airflow for 20 seconds.

15.3 Protection Control for Heating Operation

15.3.1 Overheating Protection by Intake Air Temperature Detection

Compressor will operate at limited freq., if indoor intake air temperature is 30°C or above.

15.3.2 Overheating Protection by Outdoor Air Temperature Detection

- The Max current value is regulated when the outdoor air temperature rise above 16°C in order to avoid compressor overloading.

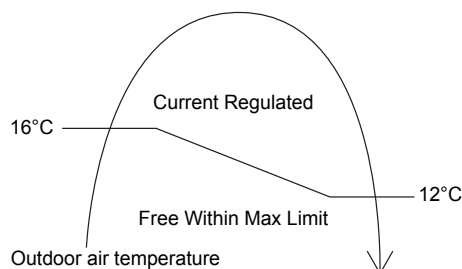

15.3.3 Overload Protection Control

- The compressor operating frequency is regulated in accordance to indoor heat exchanger temperature as shown below.
- If the heat exchanger temperature exceeds 60°C, compressor will stop.

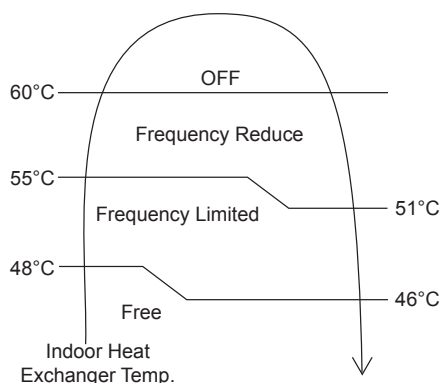

15.3.4 Cold Draught Prevention Control

- When indoor pipe temperature is low, cold draught operation starts where indoor fan speed will be reduced.

15.3.5 Deice Operation

- When outdoor pipe temperature and outdoor air temperature is low, deice operation starts.
- Deice Start condition
 - Outdoor air temperature sensor 1 detected below 9°C continuously for 40 minutes, outdoor pipe temperature sensor 1 detected below line A for 3 minutes within the next 20 minutes.
 - Outdoor air temperature sensor 1 detects temperature below 9°C continuously for 40 minutes, if the temperature is below line A and line B for 3 minutes.
 - Heating operation operates without deicing operation continuously for 24 hour, outdoor temperature is below 3°C.
- ※ Cannot operate the deicing operation if heating operation operate after 40 minutes starting operation.

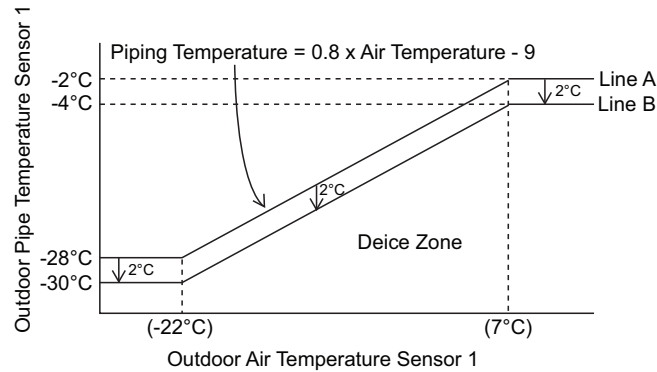

Non-stop Heating Deice Operation

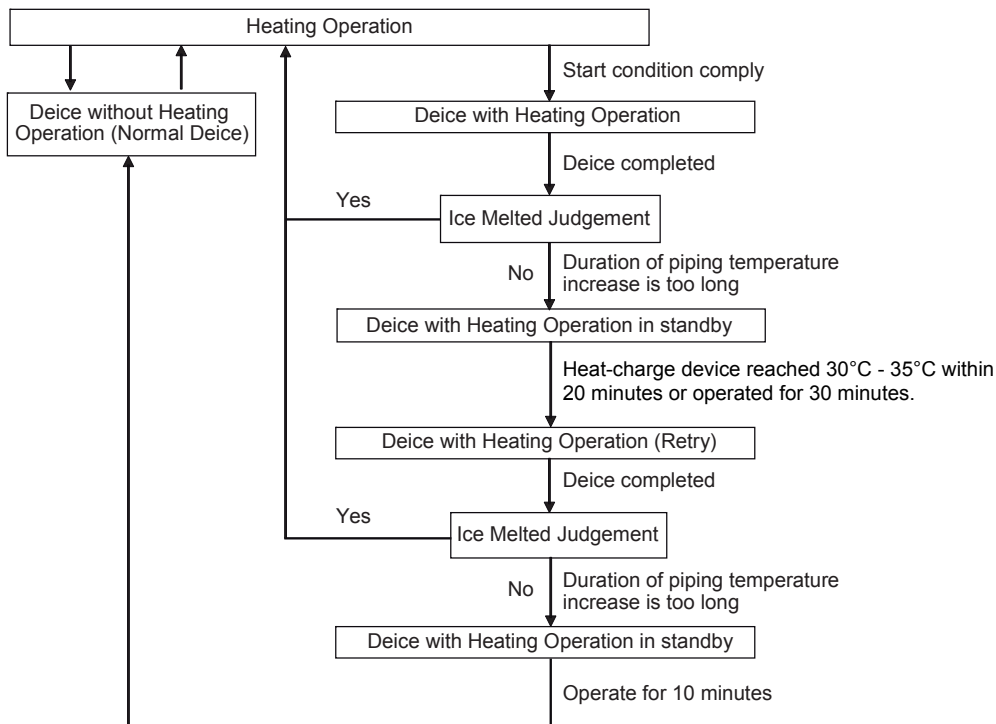

Without Heating Deice Operation

- 4-way valve is switched and deicing is performed by cooling cycle.
- Unit stop heating operation for maximum 12 minutes.
- During this operation the power indicator blinks and the vertical airflow direction louver is left open.
- After the deicing start, it'll end with either the elapsed 11 minutes, or the outdoor piping temperature is equal to or greater than the following table of temperature.

- Non-stop heating device operation is prohibited when any of the following condition is met
 - Protection control that limit capacity.
 - Aluminium electric heater (HEATCHARGE) temperature sensor abnormal.
 - Aluminium electric heater (HEATCHARGE) cycle abnormal.
 - Outdoor pipe temperature sensor 2 abnormal.
 - The outdoor temperature range falls under -30°C .
- Device stop condition
 - Outdoor air temperature is more than 9°C

15.3.6 Base Pan Heater Protection Control

Base pan heater is installed inside to the outdoor unit at base pan. It is for quickly melted ice at base pan area.

- When outdoor air temperature is 4°C , Base pan heater operation starts.
- If the temperature is more than 6°C , base pan heater operation stop.

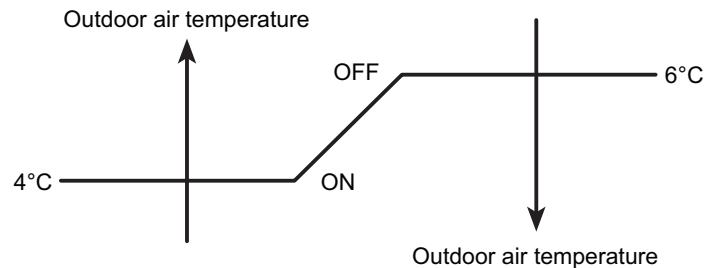

15.3.7 Aluminium Electric Heater 3-Way Valve Control

Aluminium electric heater 3-way valve temperature sensor is used for the abnormality determination of aluminium electric heater 3-way valve cycle.

Control condition:

Aluminium electric heater 3-way valve temperature sensor

Outdoor operation

- Aluminium electric heater 3-way valve temperature sensor is disconnected or short circuit continuously in 5sec. Error code H80 will be appear.

Indoor operation

- If aluminium electric heater 3-way valve temperature sensor error code (H80) is received, after powerful operation OFF in 2 minute, the operation will be continues.
- If abnormality of aluminium electric heater 3-way valve temperature sensor error code (H80) is received from outdoor once again, the operation will be continued in the stage of flashing timer.
- However, if H80 doesn't come from outdoor within 10 sec after outdoor power turned ON, abnormality will be cancelled.

Thermo OFF delay - Aluminium electric heater 3-way valve control

Aluminium electric heater 3-way valve will open before thermo OFF to change the room temperature during thermo OFF and to reduce loss during thermo ON >.

Start condition

- 1 Heater ON or compressor ON.
- 2 Control area is continued more than 90 second.
- 3 Not in protection operating of capacity limit.
- 4 Not in de-icing operation.
- 5 Temperature of outdoor piping temperature is greater than or equal to -3°C .
- 6 Indoor piping temperature is greater than or equal to 35°C .
- 7 More than 5 hours after device completed.
- 8 After more than 20 minute.
- 9 Compressor frequency (Hz) is the control area as below.

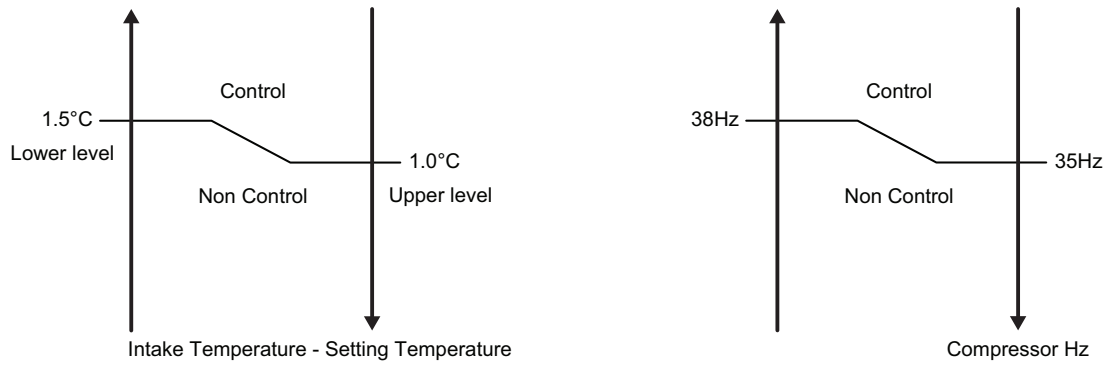

Control content

- Aluminium electric heater 3-way valve is ON in 90 sec.
- Aluminium electric heater 3-way valve ON is completed, at the time that initial conditions are not arranged.

15.3.8 Aluminium Electric Heater (HEATCHARGE) Protection Control

Heat charge will absorb the heat from compressor body and store the heat inside the storage unit. Cool refrigerant will flow through the heat charge and absorb the accumulate heat before return to compressor.

Safety control for aluminium electric heater.

- Protection by temperature sensor and temperature fuse.
- Aluminium electric heater coil surface temperature less than 100°C in normal condition.
- Aluminium electric heater coil surface temperature around 350°C ~ 390°C in abnormal condition.

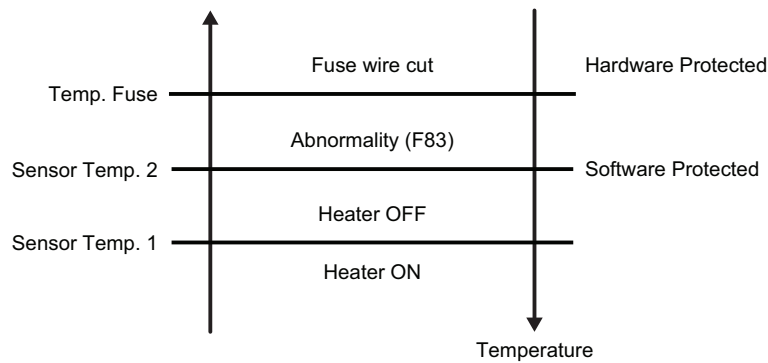

- Heater OFF by sensor (1) temperature detection.
- Heater STOP by sensor (2) temperature detection.
- Temperature fuse makes heater when software OFF protection not active.

15.3.8.1 Protection of Aluminium Electric Heater (HEATCHARGE).

OFF by Sensor

- Aluminium electric heater OFF in 85°C (normal condition)
- Temperature rise stopped at 100°C.

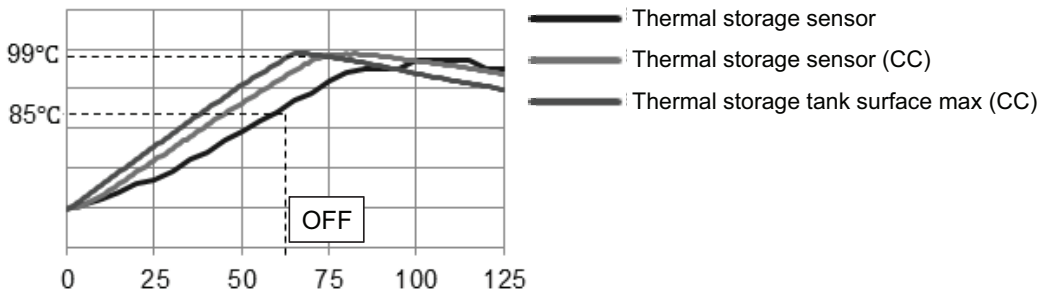

OFF by Temperature Fuse

- Fuse cut at 129°C
- Temperature rise stopped at 206°C.

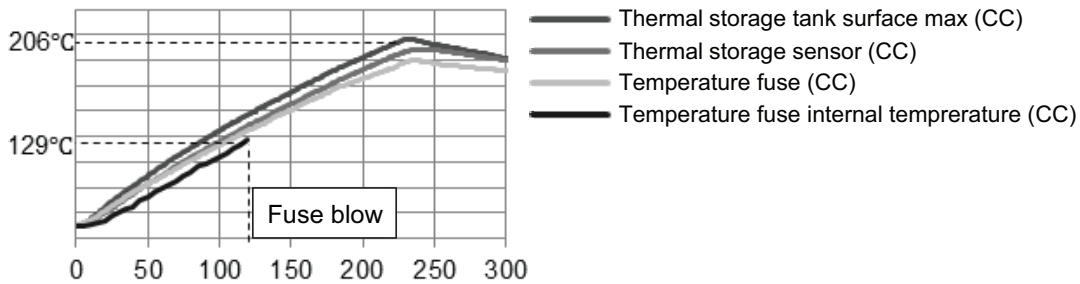

16. Servicing Mode

16.1 Auto OFF/ON Button (Indoor Unit)

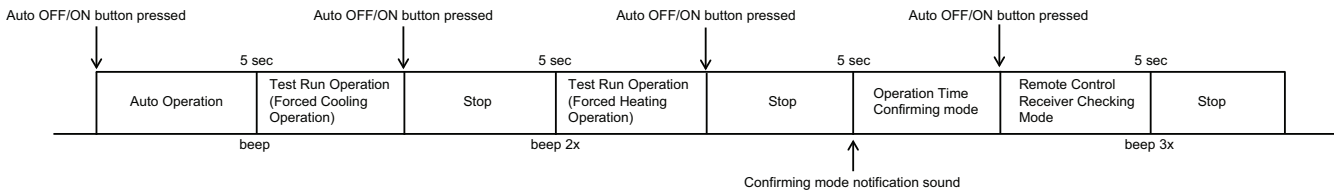

1 AUTO OPERATION MODE

The Auto operation will be activated immediately once the Auto OFF/ON button is pressed. This operation can be used to operate air conditioner with limited function if remote control is misplaced or malfunction.

2 TEST RUN OPERATION (FOR PUMP DOWN/SERVICING PURPOSE)

The Test Run operation will be activated if the Auto OFF/ON button is pressed continuously for more than 5 seconds. A "beep" sound will heard at the fifth seconds, in order to identify the starting of Test Run operation (Forced cooling operation). Within 5 minutes after Forced cooling operation start, the Auto OFF/ON button is pressed for more than 5 seconds. A 2 "beep" sounds will heard at the fifth seconds, in order to identify the starting of Forced heating operation.

In within 5 minutes after Forced heating operation start, the Auto OFF/ON button is pressed for more than 5 seconds. A confirming mode notification sound will be heard, in order to identify the starting Operation Time Checking mode. (If less than 5 seconds pressed Auto OFF/ON button, Forced heating operation will be stop). After that, in within 5 minutes after Operation Time Confirmation mode start, the Auto OFF/ON button is pressed continuously for more than 5 seconds. A 3 "beep" sound will be heard at the fifth seconds, in order to identify the starting Remote Control Receiver Checking mode. (If less than 5 seconds pressed Auto OFF/ON button, Operation Time Confirmation mode will be continued).

The Auto OFF/ON button may be used together with remote control to set / change the advance setting of air conditioner operation.

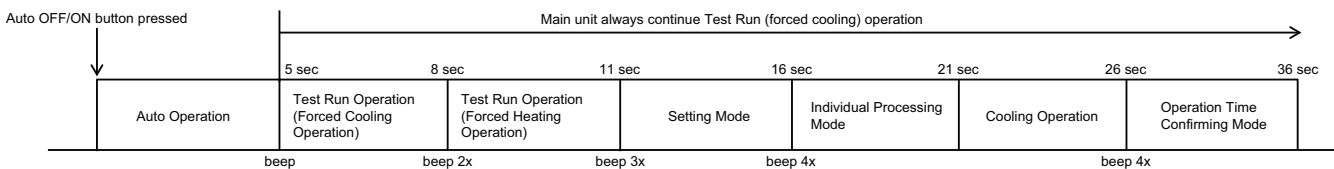

3 Notification sound

Stop receiving in operating status (LED : Light ON → Light OFF) Receive the remote control reset code	Bee
Receive notification and diagnosis code	Refer failure diagnosis function
Receive during the abnormal occurrence of protection operation (ON)	Beep beep beep beep
Receive the basic sound bit (after temperature SW is operated and when the temperature is upper threshold and lower threshold)	bleep bleep
Operation receive, stop receive, set change, single function set (other than those above)	bleep

4 OPERATION MODE

The total of cumulative operation time of heating, cooling, defrosting, automatic, blower operation that is being recorded in EEPROM will be notified by number of times of timer LED flash and notification sound.

Cumulative operation time	Number of times of LED flash and notification sound	Notification sound	
		No failure memory	Existence of failure memory
Less than 3 mins	1	bleep	bleep bleep
3 ~ 15 mins	2		
15 ~ 30 mins	3		
30 mins ~ 1hrs 30mins	4		
1hrs 30mins ~ 2hrs 30mins	5		
2hrs 30 mins and over	6		

※ EEP memory timing of cumulative operation time of operation modes is changed according to total of cumulative operation time.

Total of cumulative operation time	EEP memory timing
Less than 3 minute	Continuous operation for 3 minute and stop operation
Less than 15 minute	Continuous operation for 15 minute and stop operation
Less than 30 minute	Continuous operation for 30 minute and stop operation
30 minute and over	Stop ⇒ The first time of starting operation : continuous operation for 30 minute and stop operation More than those above : Continuous operation with 1 hour and stop operation

5 PREFERENCE SETTING MODE

- Set mode type

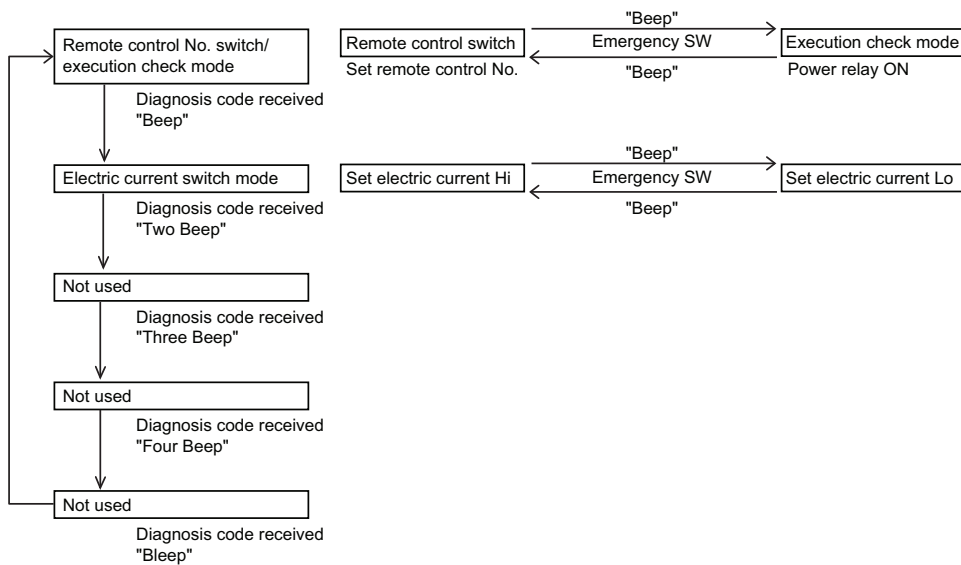

※ Each mode is cancelled if no operation is performed for 5 minutes or any code other than the diagnosis code is received from the remote control.

- Individual Mode

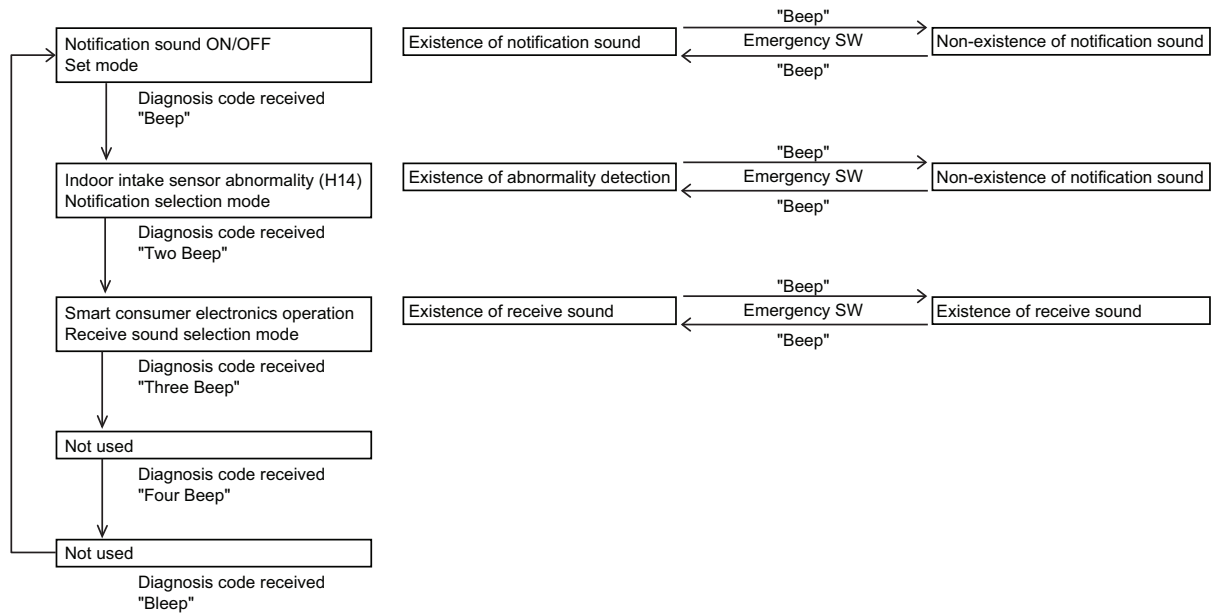

※ Each mode is cancelled if no operation is performed for 5 minutes or any code other than the diagnosis code is received from the remote control.

16.2 Remote Control Button

16.2.1 RESET

- To reset the remote control.
 - Press once to restore the unit setting.

17. Troubleshooting Guide

17.1 Refrigeration Cycle System

In order to diagnose malfunctions, make sure that there are no electrical problems before inspecting the refrigeration cycle. Such problems include insufficient insulation, problem with the power source, malfunction of a compressor and a fan.

The normal outlet air temperature and pressure of the refrigeration cycle depends on various conditions, the standard values for them are shown in the table on the right.

Normal Pressure and Outlet Air Temperature (Standard)

	Gas Pressure MPa (kg/cm ² G)	Outlet air Temperature (°C)
Cooling Mode	0.9 ~ 1.2 (9 ~ 12)	13 ~ 17
Heating Mode	2.0 ~ 2.7 (20 ~ 27)	32 ~ 42

- *Condition:
- Indoor fan speed = High
 - Outdoor temperature 35°C at the cooling mode and 7°C at the heating mode
 - Compressor operates at rated frequency

※ Forced Cooling Operation or Forced Heating Operation

Difference in the intake and outlet air temperatures

More than 8°C
(15 minutes after an operation is started.)
at cooling mode.
Above 14°C
(15 minutes after an operation is started.)
at heating mode

Normal

- Measuring the air temperature difference

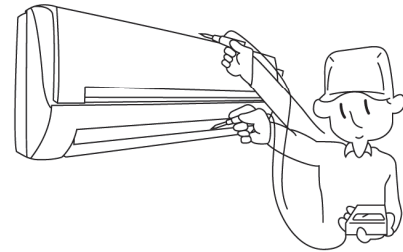

Less than 8°C at the cooling mode
Less than 14°C at the heating mode.

Value of electric current during operation

Higher than specified

Dusty condenser preventing heat radiation
Excessive amount of refrigerant

- Measuring electric current during operation

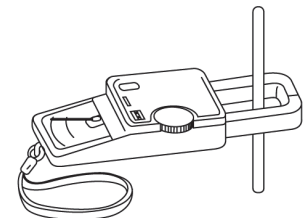

Lower than specified

Gas side pressure

Cooling Mode High
Low
Low
Heating Mode Low
Low
Low

Inefficient compressor
Insufficient refrigerant
Clogged strainer or capillary tube
Inefficient compressor
Insufficient refrigerant
Clogged strainer or capillary tube

- Measuring gas side pressure

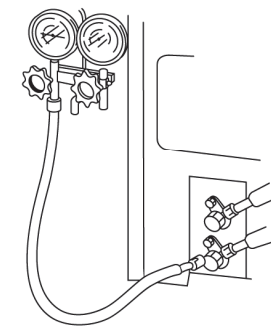

17.1.1 Relationship between the Condition of the Air Conditioner and Pressure and Electric Current

Condition of the air conditioner	Cooling Mode			Heating Mode		
	Low Pressure	High Pressure	Electric current during operation	Low Pressure	High Pressure	Electric current during operation
Insufficient refrigerant (gas leakage)	↘	↘	↘	↘	↘	↘
Clogged capillary tube or Strainer	↘	↘	↘	↗	↗	↗
Short circuit in the indoor unit	↘	↘	↘	↗	↗	↗
Heat radiation deficiency of the outdoor unit	↗	↗	↗	↘	↘	↘
Inefficient compression	↗	↘	↘	↗	↘	↘

- Carry out the measurement of pressure, electric current, and temperature fifteen minutes after an operation is started.

17.2 Breakdown Self Diagnosis Function

17.2.1 Self Diagnosis Function (Three Digits Alphanumeric Code)

- Once abnormality has occurred during operation, the unit will stop its operation and Timer LED blinks. In case of abnormality which does not affect the refrigeration cycle, the operation will not stop but the Timer LED will blink.
- Although Timer LED goes off when power supply is turned off, if the unit is operated under breakdown condition, the LED will light up again.
- In operation after breakdown repair, the Timer LED will no more blink. The last error code (abnormality will be stored in IC memory).

17.2.2 To Make a Diagnosis

- Timer LED start to blink and the unit automatically stops the operation.
- Press the INFO button on the remote controller.
- Error code will be displayed on the remote controller display for 4 seconds then it will return to the original display.
- If no information can be received from indoor unit, "RETRY" will be display for 4 seconds on the remote controller display.

17.2.3 To Display Memorized Error Code (Protective Operation)

- Turn power on (in standby condition).
- Short the DIAGNOSIS terminal, the latest error code is displayed on the remote control display.

17.2.4 To Clear Memorized Error Code after Repair (Protective Operation)

- Turn power on (in standby condition).
- Press the Auto button for 5 seconds (A beep receiving sound) on the main unit to operate the unit at Forced Cooling Operation modes.
- Short DIAGNOSIS terminal to transmit signal to main unit. A beep sound is heard from main unit and the data is cleared.

17.2.5 Temporary Operation (Depending on Breakdown Status)

- Press the AUTO button (A beep receiving sound) on the main unit to operate the unit. (Remote control will become possible.)
- The unit can temporarily be used until repair.

Error Code	Temporary items
F19, H23, H25, H27, H28, H29, H53, H59, H80	Emergency operation with limited power

17.2.6 Failure Diagnosis Function

Condition	Remote control operation		Failure diagnosis operation	
			Diagnosis sound	Diagnosis display
Normal	Notification		Bleep	-
	Diagnosis Code	The 1st time	Bleep	The latest failure diagnosis code in history
		The 2nd time	Bleep bleep	The last time failure diagnosis code in history
		The 3rd time	Bleep bleep bleep	The time prior to last one failure diagnosis code in history
Abnormal	Notification		Beep beep beep beep...(4s continuous)	The current failure diagnosis code
	Diagnosis Code		Beep beep beep beep...(4s continuous)	The current failure diagnosis code

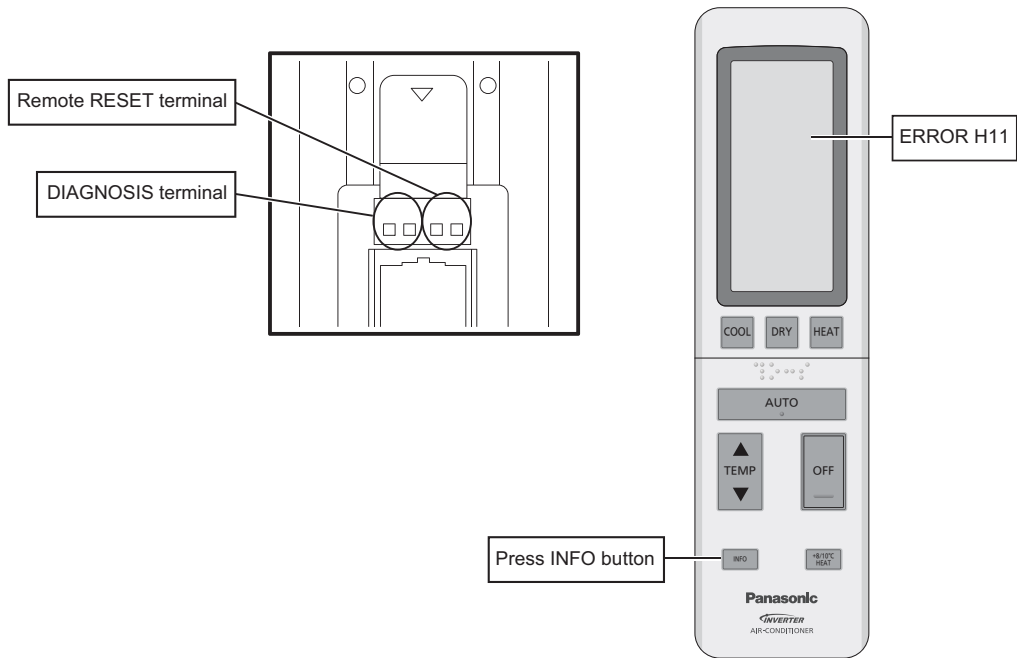

17.3 Self Diagnosis Functions and Points of Diagnosis

[List of Diagnosis Method]

Code	Name of Diagnosis	Descriptions on Diagnosis	Main Areas to be Diagnosed
—	Codes for the commencement of self diagnosis	—	—
H00	No memory of error code	—	—
H11	Indoor/outdoor communication error	When the indoor/outdoor communication failed for 15 seconds or more, the power relay is OFF for 2 minutes. Then, determine the presence of the error again. The error code is displayed when the error is detected two times. (No communication error is determined for 1 minute after the operation is started or the power relay is ON.) <Points of diagnosis> 1. The model and supply voltage of the indoor and outdoor unit are checked. 2. Ensure that the control board of the outdoor unit is working. 3. The voltage of indoor/outdoor communication line, the supply voltage of the outdoor unit and the return voltage from outdoor to indoor unit are checked.	<ul style="list-style-type: none"> • Check of the model of indoor & outdoor units • Indoor/outdoor unit connection wire • Indoor & outdoor unit control boards • Outdoor unit AC circuit components
H14	Indoor unit intake air temperature sensor error	This error code is displayed when the detected temperature of the intake air temperature sensor is below -50°C for 5 consecutive seconds, or 149°C or higher for 2 consecutive minutes after 20 minutes have elapsed since the air conditioner is turned on. <Points of diagnosis> 1. This is an error code displayed when an improbable temperature is detected. If the sensor is not open ($\geq 500k\Omega$) or short-circuited ($\leq 6.5k\Omega$), poor contact of the connector has occurred.	<ul style="list-style-type: none"> • Intake air temperature sensor (Bad connection / detached connector)
H15	Compressor temperature sensor error	This error code is displayed when the detected temperature of the compressor temperature sensor is 330°C or higher for 5 consecutive seconds, or below -16°C for 5 consecutive seconds after 5 minutes have elapsed since the compressor is started. <Points of diagnosis> 1. This is an error code displayed when an improbable temperature is detected. If the sensor is not open ($\geq 500k\Omega$) or short-circuited ($\leq 0.5k\Omega$), poor contact of the connector or a failure of control board has occurred.	<ul style="list-style-type: none"> • Compressor temperature sensor (Bad connection / detached connector)
H16	Outdoor unit CT disconnection error	If the detected total current is below 0.7A for 20 consecutive seconds when the air conditioner operates beyond its rated capacity, the air conditioner stops and this error code is displayed. (This function does not work for 3 minutes after the outdoor unit starts operating.) <Points of diagnosis> 1. Check of refrigerating cycle: Gas leak (Refrigerant level is very low.) 2. Check of control board; Check for disconnection of CT (open) only. (The control board is to be replaced in case of CT open.) ※ For scroll compressor (DC motor): H16 is usually detected only when the compressor is in operation.	<ul style="list-style-type: none"> • Low refrigerant level (almost empty) • Outdoor unit control board
H19	Indoor unit fan motor lock error	If a rotation error (too high/low speed) is detected for 10 consecutive seconds, only the fan motor is stopped and then restarted. If the rotation error is detected seven consecutive times within 25 seconds, the fan motor lock is determined and this error code is displayed. <Points of diagnosis> 1. Check for indoor unit fan motor lock. 2. Poor contact and detached fan motor connector, fan motor failure and indoor unit control board.	<ul style="list-style-type: none"> • Indoor unit control board • Indoor unit fan motor (Bad connection / detached connector)
H23	Indoor unit heat exchanger temperature sensor error	This error code is displayed when the detected temperature of the indoor unit heat exchanger temperature sensor is below -50°C or 149°C or higher for 5 consecutive seconds. (The temperature is not detected during De-Icing.) <Points of diagnosis> 1. This is an error code displayed when an improbable temperature is detected. If the sensor is not open ($\geq 500k\Omega$) or short-circuited ($\leq 2.5k\Omega$), poor contact of the connector or a failure of control board has occurred.	<ul style="list-style-type: none"> • Indoor unit heat exchanger temperature sensor (Bad connection / detached connector)
H27	Outdoor temperature sensor error	This error code is displayed when the detected temperature of the outdoor temperature sensor is below -40°C or 150°C or higher for 5 consecutive seconds. <Points of diagnosis> 1. This is an error code displayed when an improbable temperature is detected. If the sensor is not open ($\geq 500k\Omega$) or short-circuited ($\leq 0.5k\Omega$), poor contact of the connector or a failure of control board has occurred.	<ul style="list-style-type: none"> • Outdoor temperature sensor (Bad connection / detached connector)

H28	Outdoor unit heat exchanger temperature sensor 1 error	This error code is displayed when the outdoor unit heat exchanger temperature sensor 1 is below -58°C or 107°C or higher for 5 consecutive seconds. <Points of diagnosis> 1. This is an error code displayed when an improbable temperature is detected. If the sensor is not open ($\geq 500k\Omega$) or short-circuited ($\leq 0.5k\Omega$), poor contact of the connector has occurred.	<ul style="list-style-type: none"> Outdoor unit heat exchanger temperature sensor 1 (Bad connection / detached connector)
H29	Outdoor unit heat exchanger temperature sensor 2 error	This error code is displayed when the detected temperature of the outdoor temperature sensor 2 is below -58°C or 107°C or higher for 5 consecutive seconds. <Points of diagnosis> 1. This is an error code displayed when an improbable temperature is detected. If the sensor is not open ($\geq 500k\Omega$) or short-circuited ($\leq 0.5k\Omega$), poor contact of the connector or a failure of control board has occurred.	<ul style="list-style-type: none"> Outdoor unit heat exchanger temperature sensor 2 (Bad connection / detached connector)
H33	Connection error of the models with different voltage power supply	This error code is displayed when the models of indoor and outdoor units are different or connected to 100V and 200V models, respectively. ※ This function does not apply to the case where the supply voltage of the indoor unit is doubled. <Points of diagnosis> 1. Check for the model compatibility between indoor & outdoor units; Check of supply voltage. 1 200V indoor unit: When 100V or 200V is supplied and the outdoor unit is a 100V model: The indoor unit immediately turns off the power relay and H33 is displayed. After the reset is cancelled, the power relay does not turn on if the indoor unit is a 200V model. 2 Both indoor and outdoor units are 200V models and 100V power is supplied: If the DC voltage of the outdoor unit is 180V or below after 20 seconds from power relay ON, the signal is transmitted to the indoor unit. If the error occurs one more time, H33 is displayed. 3 100V indoor unit: When 100V is supplied and the outdoor unit is a 200V model: The indoor unit immediately turns off the power relay and H33 is displayed.	<ul style="list-style-type: none"> Model difference between indoor & outdoor units Check of supply voltage
H38	Brand not corresponding	This error code is displayed when the connection is different between the indoor and outdoor units. <Points of diagnosis> 1. Check of models and capabilities of indoor and outdoor units. 2. Short-circuit of CN-S on outdoor unit control board.	<ul style="list-style-type: none"> Models of indoor and outdoor units
H53	Aluminium Electric Heater (Heatcharge) sensor abnormality	When the Aluminium Electric Heater (Heatcharge) sensor detects less than -47°C, or, at or more than 190°C for 5 seconds. <Points of diagnosis> Abnormality display when detecting an unusual temperature. Check the sensor; it might be connection abnormality of the connectors and PCB abnormality, if the sensor is not open (at or more than 500k Ω) or short (0.6k Ω).	<ul style="list-style-type: none"> Aluminium Electric Heater (Heatcharge) sensor (wire cut / short)
H54	Abnormality in Aluminium Electric Heater (Heatcharge) circuit	After 6 seconds from switching on the outdoor unit, the total amperage value is judged to be abnormal. <Points of diagnosis> 1. Check the Aluminium Electric Heater (Heatcharge): short circuit. 2. Check PCB: only check Aluminium Electric Heater (Heatcharge): change PCB if the circuit is open.	<ul style="list-style-type: none"> Aluminium Electric Heater (Heatcharge) Outdoor unit PCB
H59	Infrared sensor error	This error code is displayed when the infrared sensor shows no response within 30 seconds after it is ON or continuously responds between 80 and 250 seconds after it is ON. <Points of diagnosis> 1. Check of the detection and location of the infrared sensor. 2. Check for disconnection and detached infrared sensor.	<ul style="list-style-type: none"> Infrared sensor (Bad connection / disconnection / detached connector)
H67	Nano-e abnormality	Detection of wire cut When the main PCB receives abnormal signal from Nano-e control PCB after 1 to 7 seconds subsequent to switching on Nano-e, power supply to Nano-e is stopped for 5 minutes and re-started after that. Having repeated this procedure for 3 times, Nano-e abnormality is detected.	<ul style="list-style-type: none"> PBC Nano-e system High voltage device
H70	Sunlight sensor error	When 24-hour disconnection is detected for 15 consecutive days, the diagnosis code "H70" is displayed on the indoor unit and ECONAVI LED is OFF. (The air conditioner continues the operation.) <Points of diagnosis> 1. Failure of the sunlight sensor. 2. Detached sunlight sensor connector.	<ul style="list-style-type: none"> Sunlight sensor (Bad connection of connector)
H80	Aluminium Electric Heater (Heatcharge) 3-way valve sensor abnormality	When wire cut or short circuit of Aluminium Electric Heater (Heatcharge) 3-way valve is repeatedly detected in continuous 5 seconds, the power relay is stopped for 2 minutes, and after re-starting, the wire cut or short circuit is detected in 5 continuous seconds within 10 seconds, the timer lamp blinks (the operation is continued). <Points of diagnosis> 1. This is an abnormality indication of unusual temperature detection. Check the sensor, and if the sensor is not open or shorted, improper connector connection or PCB defect is suspected.	<ul style="list-style-type: none"> Aluminium Electric Heater (Heatcharge) 3-way valve sensor (connector connection abnormality/ detachment)

H96	2- and 3-way valve opening failure check	Failure to open the 2- and 3-way valve is detected based on the changes in indoor unit intake air temperature and indoor unit pipe temperature. The time required for this detection is approximately 10 minutes when in COOL mode and approximately 25 minutes when in HEAT mode. <Points of diagnosis> 1. Check if the 2-way and 3-way valves are closed.	<ul style="list-style-type: none"> • 2- and 3-way valve opening failure
H97	Outdoor unit fan motor lock error	If a rotation error (too high/low speed) is detected for 10 consecutive seconds, only the fan motor is stopped and then restarted. If the rotation error is detected 2 consecutive times or if an overcurrent (fan motor current 3A and above) is detected, the compressor is stopped, and then restarted after 180 seconds. If the error or overcurrent is detected two times within 20 minutes, this error code is displayed. <Points of diagnosis> 1. Check for outdoor unit fan motor lock. 2. Poor contact and detached fan motor connector, fan motor failure and outdoor unit control board.	<ul style="list-style-type: none"> • Outdoor unit control board • Outdoor unit fan motor (Bad connection / detached connector)
H98	Indoor unit overpressure protection	When the temperature of the indoor unit heat exchanger temperature sensor exceeds 60°C during the heating operation, this diagnosis code is stored in the memory and the compressor stops operation. It resumes operation after 180 seconds if the temperature is below 60°C. No error code is displayed. <Points of diagnosis> 1. Check of the indoor unit heat exchanger temperature sensor (Check for change in characteristic and resistance value): Symptom – No hot start, no thermo ON and repeating stop and start during the start of the operation. 2. Additional check for short-circuit of the indoor unit and clogging of air filter.	<ul style="list-style-type: none"> • Dirt on air filter • Short-circuit of indoor unit
H99	Indoor unit heat exchanger freezing protection	When the temperature of the indoor unit heat exchanger temperature sensor is 0°C for 6 consecutive minutes during the cooling or dry operation, this diagnosis code is stored in the memory and the compressor stops. It resumes operation after 180 seconds if the temperature is 10°C and above. No error code is displayed. <Points of diagnosis> 1. The primary cause is cooling or dry operation at low outside temperature. This is not a failure. H99 is also displayed if dry operation is performed under AUTO mode in winter while the outside temperature goes up. 2. Check of refrigerant cycle: Gas leak (refrigerant level is low) and pipe breakage. 3. Additional check for short-circuit of the indoor unit and clogging of air filter.	<ul style="list-style-type: none"> • Low refrigerant level (relatively low) • Dirt on air filter • Short-circuit of indoor unit
F11	Cooling-Heating switching error	When the temperature of the indoor unit heat exchanger temperature sensor after 4 minutes from the start of compressor is 45°C and above during cooling or dry cool operation or below 0°C during heating operation, this diagnosis code is stored in the memory and the compressor stops. It resumes operation after 180 seconds. The error code is displayed if this error is detected four times within 40 minutes. <Points of diagnosis> 1. Check of the 4-way valve: Check for disconnection or short-circuit of the 4-way valve coil. 2. If the 4-way valve is normal, then switching error of the 4-way valve has occurred.	<ul style="list-style-type: none"> • 4-way valve • 4-way valve coil
F19	Aluminium Electric Heater (Heatcharge) wire cut abnormality	When the total electric current value is judged to be abnormal after Aluminium Electric Heater (Heatcharge) is switched ON during 6-12 seconds after switched on the outdoor unit. <Points of diagnosis> 1. Check the Aluminium Electric Heater (Heatcharge) PCB: in-motion temperature: 160°C, revert back temperature: 125°C. 2. Check temperature fuse Aluminium Electric Heater (Heatcharge) power source: In-motion temperature heat fuse at 129°C, Aluminium Electric Heater (HEATCHARGE) power source wire cut at 240°C. 3. Check PCB: only check Aluminium Electric Heater (Heatcharge) PCB: change PCB if open.	<ul style="list-style-type: none"> • Aluminium Electric Heater (Heatcharge) PCB (wire cut) • Temperature fuse (wire cut) • Outdoor unit PCB

F83	Prevention of over-increase of Aluminium Electric Heater (Heatcharge) temperature	When the Aluminium Electric Heater (Heatcharge) is switched ON, if the sensor detects more than 85 °C of heat, the power supply to the Aluminium Electric Heater (Heatcharge) is switched OFF. Furthermore, when more than 100 °C is detected, the error code is shown.	<ul style="list-style-type: none"> Over-increase of Aluminium Electric Heater (Heatcharge) temperature Aluminium Electric Heater (Heatcharge) sensor Blockage of Aluminium Electric Heater (Heatcharge) heat radiation
F86	Aluminium Electric Heater (Heatcharge) 3-way valve cycle abnormality	<p>[Heating operation] No blinking of timer LED</p> <p>When any of the following conditions is met, the error code is stored in the system. No indication of error code is given.</p> <ul style="list-style-type: none"> While the compressor operates at a fixed speed, Outdoor heat exchanger sensor 1 – Aluminium Electric Heater (Heatcharge) 3-way valve sensor $\geq 18^{\circ}\text{C}$ Close to the completion of non stop deice, Outdoor heat exchanger sensor 2 < Aluminium Electric Heater (Heatcharge) 3-way valve sensor temperature <p>[Operation other than heating mode]</p> <p>An error code is shown when all of the following conditions are fulfilled for 10 seconds within 70 to 250 seconds in cooling mode.</p> <ul style="list-style-type: none"> Compressor temperature – Outdoor heat exchanger sensor 2 temperature $\geq 20^{\circ}\text{C}$ Outdoor heat exchanger sensor 2 temperature – Outside temperature $< 5^{\circ}\text{C}$ Present compressor temperature – compressor temperature at the operation start $\geq 25^{\circ}\text{C}$ or compressor temperature $\geq 100^{\circ}\text{C}$ 	<ul style="list-style-type: none"> Aluminium Electric Heater (Heatcharge) 3-way valve clogged Wire cut of Aluminium Electric Heater (Heatcharge) 3-way valve coil Outdoor unit PCB Refrigerant leakage Abnormal resistance of Aluminium Electric Heater (Heatcharge) 3-way valve sensor
F90	PFC protection	<p>The compressor stops if the DC voltage of the outdoor unit control board (PFC output) exceeds the preset value for protection against over-voltage. The error code is displayed if the protection is activated four times within 20 minutes.</p> <p><Points of diagnosis></p> <ol style="list-style-type: none"> Check of the inverter circuit on the control board: The voltage of IPM is checked within 3 minutes after the power is OFF and then ON. Symptom: The compressor stops after 30 seconds from its start and F90 is stored in the memory. The error code is displayed once the compressor is restarted four times. 	<ul style="list-style-type: none"> Outdoor unit control board
F91	Refrigeration cycle error	<p>While the air conditioner is in operation beyond the ratings, this diagnosis code is stored in the memory and the compressor stops if:</p> <ul style="list-style-type: none"> During cooling or dry cool operation: Indoor unit intake air temperature - Indoor unit pipe temperature $< 4^{\circ}\text{C}$ During heating operation: Indoor unit pipe temperature - Indoor unit intake air temperature $< 5^{\circ}\text{C}$ <p>In the case where the air conditioner operates within the total current range of 0.7 – 1.4A for 5 minutes. The compressor resumes operation after 180 seconds. The error code is displayed if this error is detected two times within 20 minutes.</p> <p><Points of diagnosis></p> <ol style="list-style-type: none"> Check of refrigerating cycle: Gas leak. (Gas level is less than a half.) The diagnosis code to be displayed due to gas leak changes in the order of H99 → F97 → F91 → H16 depending on the amount of gas leaked. The range of this error (F91) is extremely small. (Protection of the compressor at the beginning of a season) 	<ul style="list-style-type: none"> Draining of refrigerant (3-way valve opening failure, gas leak, etc.)
F93	Compressor rotation error	<p>If the rotation of the compressor does not synchronize with the control signal, this diagnosis code is stored in the memory and the compressor stops. It resumes operation after 180 seconds. The error code is displayed if this error is detected four times within 20 minutes.</p> <p><Points of diagnosis></p> <ol style="list-style-type: none"> Symptom caused by the failure to open the 2-way and 3-way valves: The compressor stops after it operates for 1 to 3 minutes from its start and F93 is stored in the memory. Check of the inverter circuit of the control circuit: The IPM base current is checked (6 locations) within 3 minutes after the power is turned off and on. Symptom: The compressor stops after 30 seconds from its start and F93 is stored in the memory. The error code is displayed once the compressor is restarted four times. Check of the disconnection of the compressor coil (open): Approximately 1Ω when each phase is in normal state (The symptom is the same as the above 2.). 	<ul style="list-style-type: none"> Outdoor unit control board 3-way valve opening failure Detached compressor connector Compressor phase interruption
F95	Overpressure protection in case of cooling error	<p>When the temperature of the outdoor unit heat exchanger temperature sensor 1 exceeds 61°C during the cooling or dry cool operation, this diagnosis code is stored in the memory and the compressor stops operation. No error code is displayed.</p> <p><Points of diagnosis></p> <ol style="list-style-type: none"> Check of the outdoor unit heat exchanger temperature sensor 1. (Check for change in characteristic and resistance value.) Check for interrupted heat radiation on the outdoor unit. 	<ul style="list-style-type: none"> Outdoor unit heat exchanger temperature sensor 1 Interrupted heat radiation

F96	Transistor module over-temperature protection	Overheat is detected in the IPM to block the heat. The diagnosis code is stored in the memory and the compressor stops. The error code is displayed if this error is detected four times within 30 minutes. <Points of diagnosis> 1. Interrupted heat radiation on the outdoor unit and the failure of outdoor unit fan. (The outdoor unit fan does not rotate.) 2. Failure of IPM (outdoor unit control board). 3. Check for short-circuit and continuity of IPM sensor.	<ul style="list-style-type: none"> Interrupted heat radiation Outdoor unit fan motor failure Overload conditions
F97	Compressor over-temperature protection	When the temperature of the compressor exceeds 103°C, the diagnosis code is stored in the memory and the compressor stops. It resumes operation after 180 seconds when the temperature is 92°C or below. The error code is displayed if this error is detected four times within 20 minutes. <Points of diagnosis> 1. Check of refrigerating cycle: Gas leak (Low refrigerant level). Symptom: The outdoor unit sometimes stops. 2. The compressor temperature sensor is checked when the error code is displayed and the compressor stops. (Check for change in characteristic and resistance value.) 3. Interrupted heat radiation on the outdoor unit and the failure of outdoor unit fan. (The unit fan does not rotate due to open state.) (The error is sometimes detected in case of overload. In this case, F97 remains in the memory.)	<ul style="list-style-type: none"> Low refrigerant level (relatively low) Interrupted heat radiation Overload conditions
F98	Total current protection	If the total current exceeds the preset value, this diagnosis code is stored in the memory and the compressor stops. It resumes operation after 180 seconds. The error code is displayed if this error is detected three times within 20 minutes. [Refer to "Total Current Protection Control" for the preset value] <Points of diagnosis> 1. AC voltage of the outdoor unit terminal board during operation: The voltage should drop by less than 5% from the voltage at the STOP state. (The rated voltage is to be ±110% even during the operation.) If the voltage drops by not less than 5%, or in case of sudden change in voltage, check for the length/thickness of the indoor wiring and indoor/outdoor connection wire. 2. Check for the interrupted heat radiation on the outdoor unit (during cooling operation): The outdoor unit is usually not stopped and only subjected to the capacity restriction by way of current control. No diagnosis code is displayed.	<ul style="list-style-type: none"> High refrigerant level Interrupted heat radiation
F99	DC peak operation error	When overcurrent, overheat or drop in supply voltage is detected in the IPM within 30 seconds from the start of the compressor, the compressor stops and then resume operation in 60 seconds. When the error is detected seven consecutive times, the compressor stops operation and the error code is displayed. <Points of diagnosis> 1. The compressor stops under F99 within 30 seconds from its start: When the lead wires are disconnected from U, V and W on the IPM then operate: <ul style="list-style-type: none"> If F93 is displayed and the compressor stops: Check of refrigerating cycle, 3-way valve opening failure, clogged pipe, failure of compressor (disconnection of coil). If F99 is displayed and the compressor stops: Check for IPM power supply of DC15V (4 locations) and voltage of DC280V. Failure of outdoor unit control board. 2. If the compressor stops after it operates for more than 5 minutes, a failure of the power circuit and refrigerant cycle is also checked.	<ul style="list-style-type: none"> Compressor Outdoor unit control board

[Examples of the How to Identify the Faulty Point]

The following is some flow charts which illustrate on how to identify the faulty point for each code (examples).

17.4 Self-diagnosis Method

17.4.1 H11 (Indoor/Outdoor Communication Error)

Troubleshooting

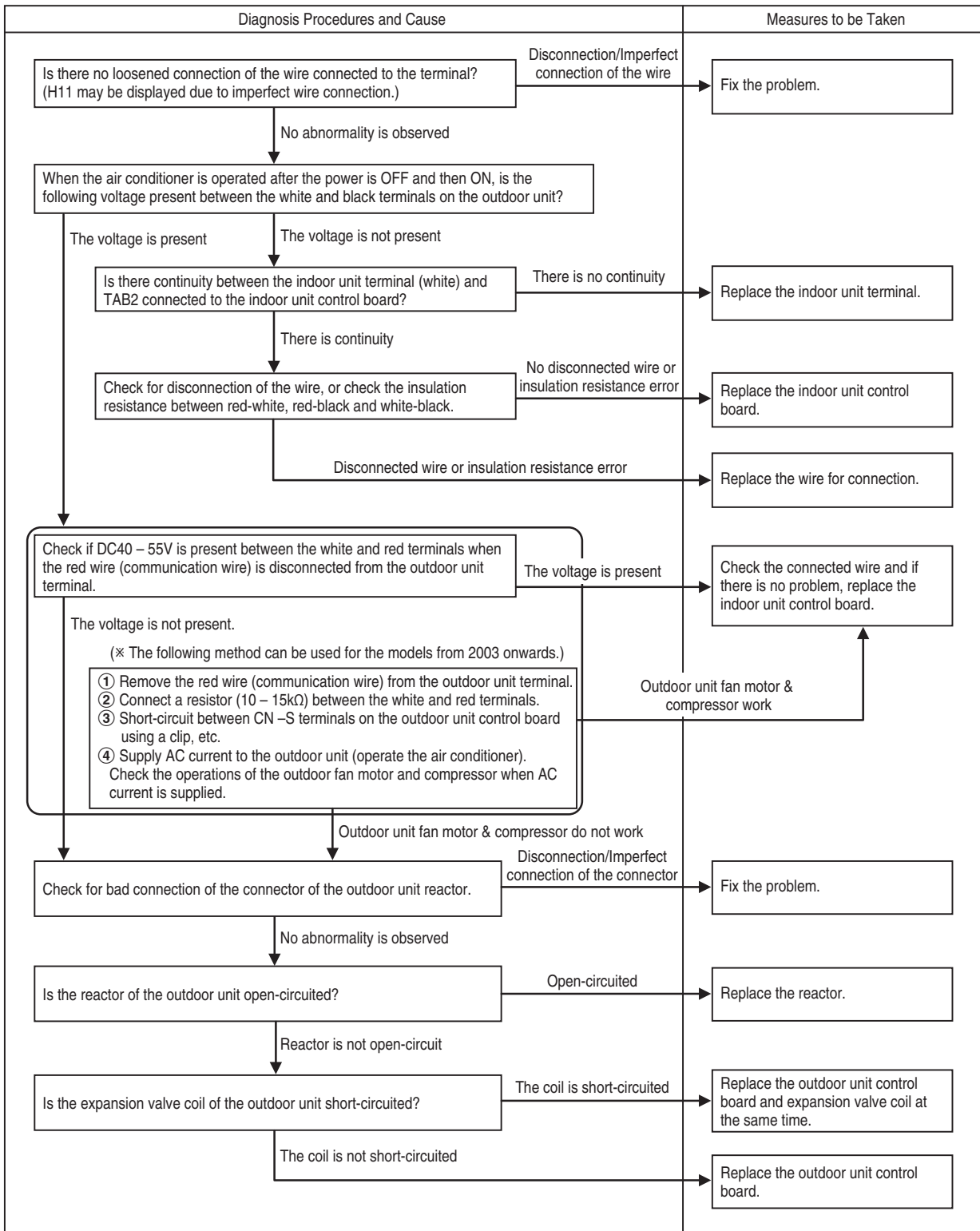

17.4.2 H14 (Indoor Unit Intake Air Temperature Sensor Error)

Troubleshooting

Diagnosis Procedures and Cause	Measures to be Taken
<p>Check the ambient temperature of the indoor unit during operation.</p>	<p>46°C and above → Improve the ambient temperature.</p>
<p>Below 46°C</p> <p>Check for bad connection of the connector of the indoor unit intake air temperature sensor.</p>	<p>Disconnection/Imperfect connection of the connector → Fix the problem.</p>
<p>No abnormality is observed</p> <p>Check for the characteristics of the sensor. ※ Refer to the characteristic table for electronic circuit diagram. (Remove the connector and check the resistance value of the sensor.)</p>	<p>An abnormality is observed → Replace the indoor unit intake air temperature sensor.</p>
<p>No abnormality is observed</p>	<p>→ Replace the indoor unit control board.</p>
<p>※ For some models, the sensor is not connected by a connector but it is directly soldered to the board. In this case, replace the control board.</p>	

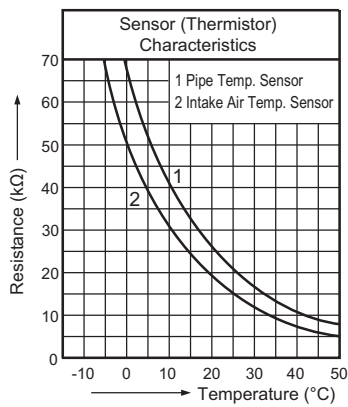

17.4.3 H15 (Compressor Temperature Sensor Error)

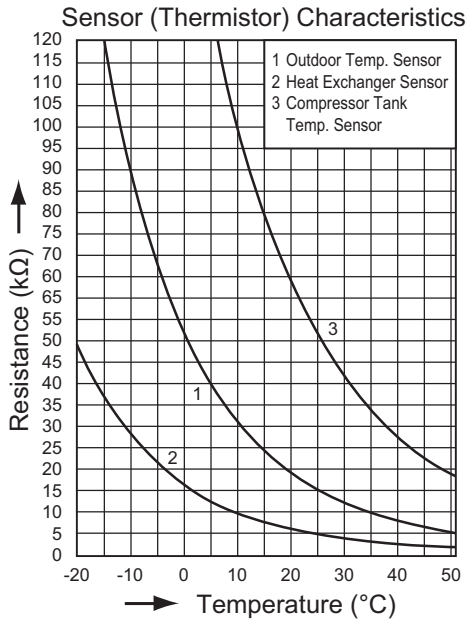

17.4.4 H16 (Outdoor Unit CT Disconnection Error)

Troubleshooting

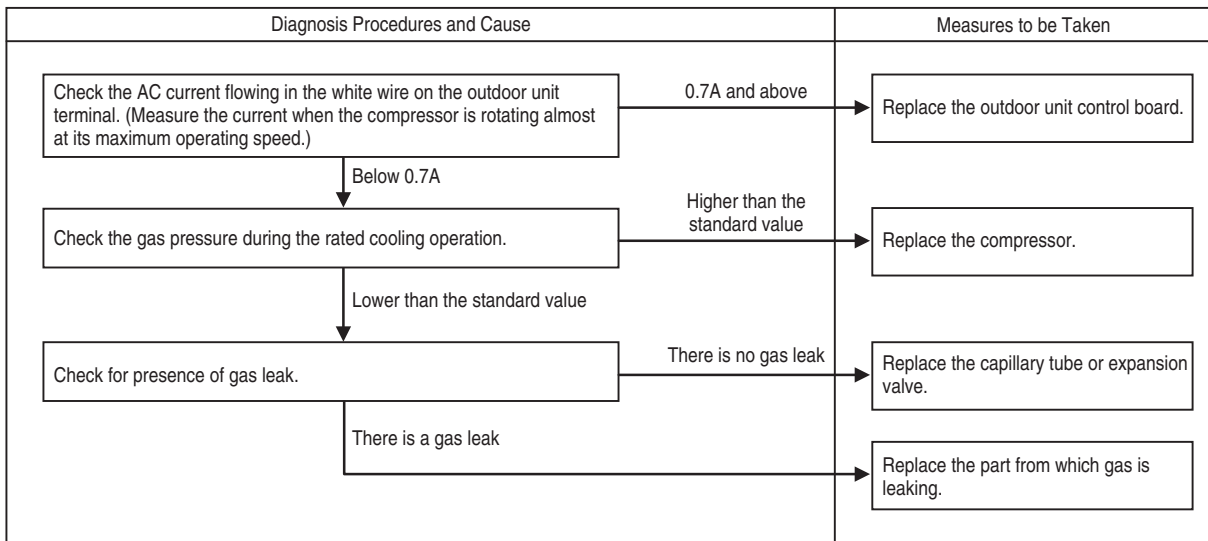

17.4.5 H19 (Indoor Unit Fan Motor Lock Error)

Troubleshooting

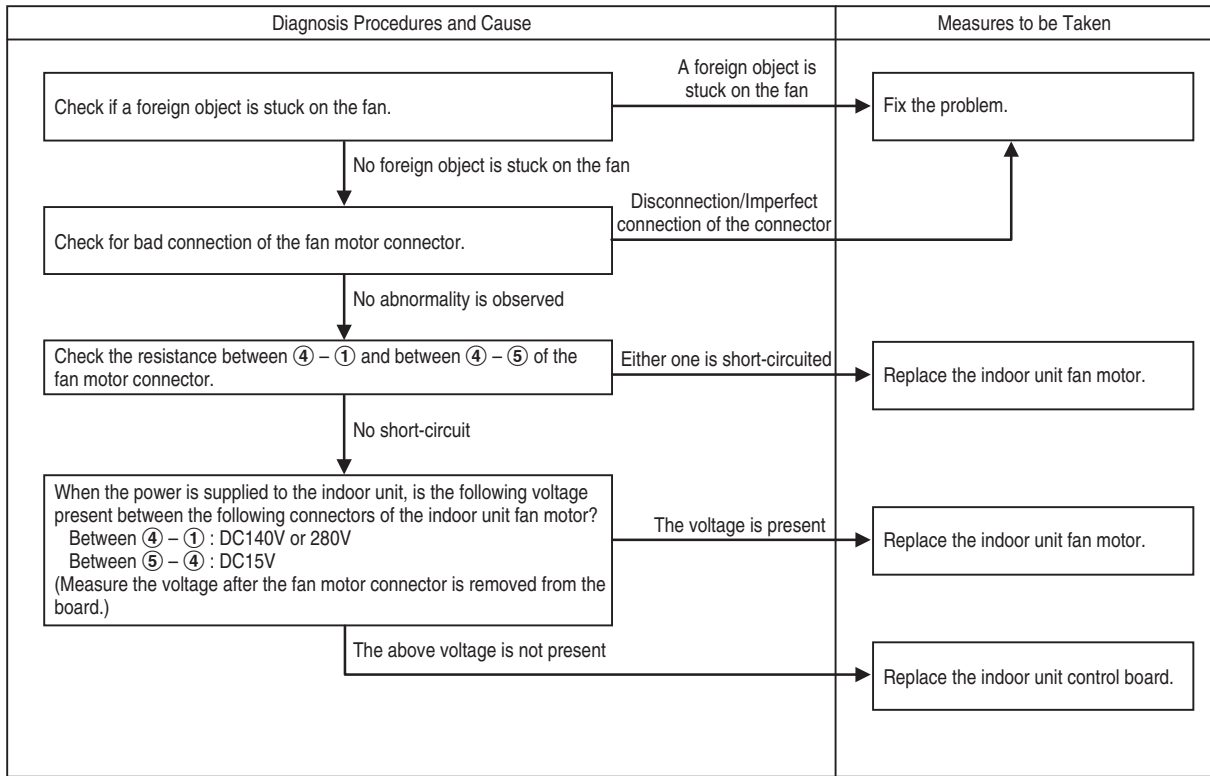

17.4.6 H23 (Indoor Unit Heat Exchanger Temperature Sensor Error)

Check the Resistance of Thermistor.

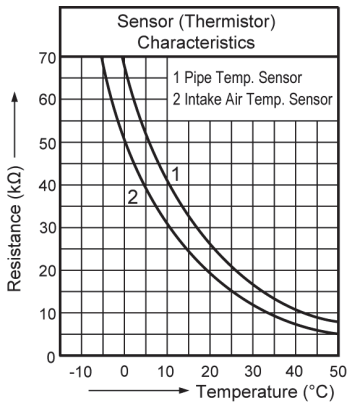

17.4.7 H27 (Outdoor Temperature Sensor)

17.4.8 H28 (Outdoor Heat Exchanger Temperature Sensor 1 Error)

17.4.9 H29 (Outdoor Heat Exchanger Temperature Sensor 2 Error)

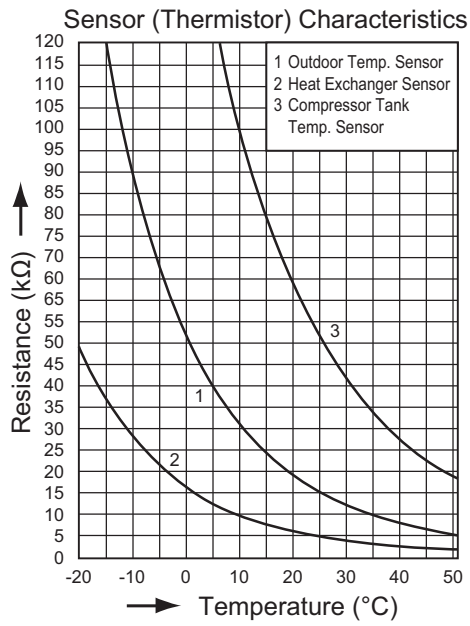

17.4.10 H33 (Connection Error of the Models with Different Voltage Power Supply)

Troubleshooting

Diagnosis Procedures and Cause	Measures to be Taken
<p data-bbox="252 360 858 427">Are the indoor and outdoor units connected following the correct voltage specifications?</p> <p data-bbox="555 443 778 472">No abnormality is observed</p>	<p data-bbox="890 342 1023 383">An abnormality is observed</p> <p data-bbox="1086 376 1407 427">Fix the problem.</p> <p data-bbox="1086 465 1407 517">Replace the control boards of indoor and outdoor unit.</p>

17.4.11 H38 (Brand not Corresponding)

Troubleshooting

Diagnosis Procedures and Cause	Measures to be Taken
<p data-bbox="199 358 805 425">Are the correct models of indoor and outdoor units connected?</p> <p data-bbox="502 436 805 492">No abnormality is observed</p>	<p data-bbox="1029 358 1348 425">Fix the problem.</p> <p data-bbox="1029 459 1348 526">Replace the control boards of indoor and outdoor unit.</p>

17.4.12 H53 (Aluminium Electric Heater (Heatcharge) Temperature Sensor Error)

Troubleshooting

Diagnosis Procedures and Cause	Measures to be Taken
<div style="border: 1px solid black; padding: 5px; margin-bottom: 10px;">Check for bad connection of the sensor connector.</div> <p style="text-align: right; margin-right: 20px;">Disconnection/Imperfect connection of the connector</p>	<div style="border: 1px solid black; padding: 5px; margin-bottom: 10px;">Fix the problem.</div>
<p style="text-align: center;">↓ No abnormality is observed</p> <div style="border: 1px solid black; padding: 5px; margin-bottom: 10px;">Check for the characteristics of the sensor. ※ Refer to the characteristic table for electronic circuit diagram. (Remove the connector and check the resistance value of the sensor.)</div> <p style="text-align: right; margin-right: 20px;">An abnormality is observed</p>	<div style="border: 1px solid black; padding: 5px; margin-bottom: 10px;">Replace the sensor.</div>
<p style="text-align: right; margin-right: 20px;">No abnormality is observed</p>	<div style="border: 1px solid black; padding: 5px; margin-bottom: 10px;">Replace the control board.</div>
<p>※ For the heat exchanger temperature sensor of some models, the sensor is not connected by a connector but it is directly soldered to the board. In this case, replace the control board.</p>	

17.4.13 H54 (Aluminium Electric Heater (Heatcharge) PCB Abnormality)

Troubleshooting

Diagnosis Procedures and Cause	Measures to be Taken
<div data-bbox="199 369 766 436" style="border: 1px solid black; padding: 5px; display: inline-block;">PCB abnormality</div>	<div data-bbox="1029 369 1348 436" style="border: 1px solid black; padding: 5px; display: inline-block;">Replace the PCB</div>

17.4.14 H59 (Infrared Sensor Error)

Troubleshooting

Diagnosis Procedures and Cause	Measures to be Taken
<p>Check for bad connection of the connector of the infrared sensor unit.</p> <p style="text-align: right;">Disconnection/Imperfect connection of the connector</p>	<p>Fix the problem.</p>
<p style="text-align: center;">No abnormality is observed</p>	
<p>Is DC5V present between ① – ③ of the infrared sensor unit?</p> <p style="text-align: right;">An abnormality is observed</p>	<p>Replace the indoor unit control board.</p>
<p style="text-align: center;">No abnormality is observed</p>	<p>Replace the infrared sensor unit.</p>

17.4.15 H67 (nanoe Abnormality)

Troubleshooting

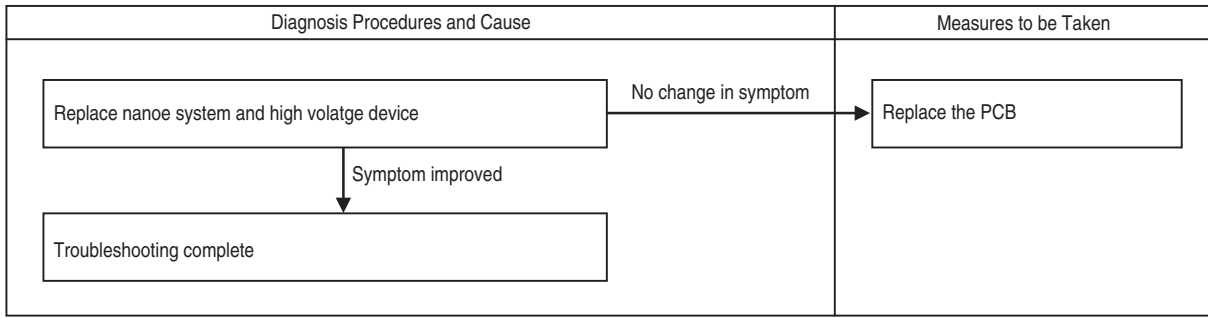

17.4.16 H70 (Sunlight Sensor Error)

Troubleshooting

Diagnosis Procedures and Cause	Measures to be Taken
<p data-bbox="252 360 818 421">Replace the board on which the sunlight sensor is mounted, and then check for the error in the sunlight sensor check mode.</p> <p data-bbox="555 439 775 465">No abnormality is observed</p> <p data-bbox="252 510 424 537">Repair is completed.</p>	<p data-bbox="1086 376 1401 403">Replace the indoor unit control board.</p>

17.4.17 H80 (Aluminium Electric Heater (Heatcharge) 3-Way Valve Sensor Abnormality)

Troubleshooting

Diagnosis Procedures and Cause	Measures to be Taken
<div style="border: 1px solid black; padding: 5px; margin-bottom: 10px;"> Check sensor connection abnormality </div> <div style="margin-left: 100px;"> ↓ Normal </div> <div style="border: 1px solid black; padding: 5px; margin-bottom: 10px;"> Check sensor characteristics Check the resistance of the sensor </div> <div style="margin-left: 100px;"> ↓ Normal </div> <p> ※ In some the models for the heat exchanger temperature sensor, the sensor has been soldered directly to the board rather than the connector connection. For that case, please change the system PCB. </p>	<div style="border: 1px solid black; padding: 5px; margin-bottom: 10px;"> Re-connect the connector </div> <div style="border: 1px solid black; padding: 5px; margin-bottom: 10px;"> Replace the sensor </div> <div style="border: 1px solid black; padding: 5px;"> Replace the PCB </div>

17.4.18 H96 (2-Way and 3-Way Valve Opening Failure Check)

Troubleshooting

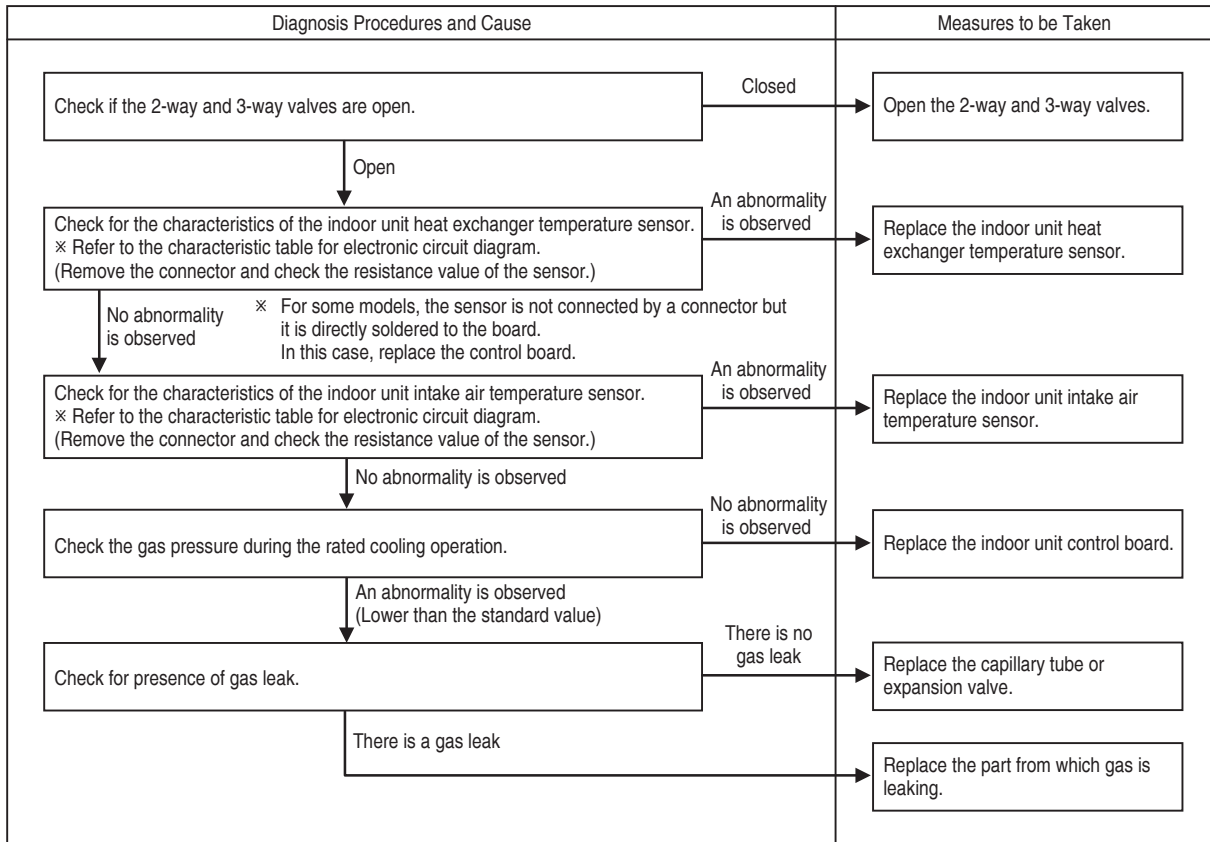

17.4.19 H97 (Outdoor Unit Fan Motor Lock Error)

Troubleshooting

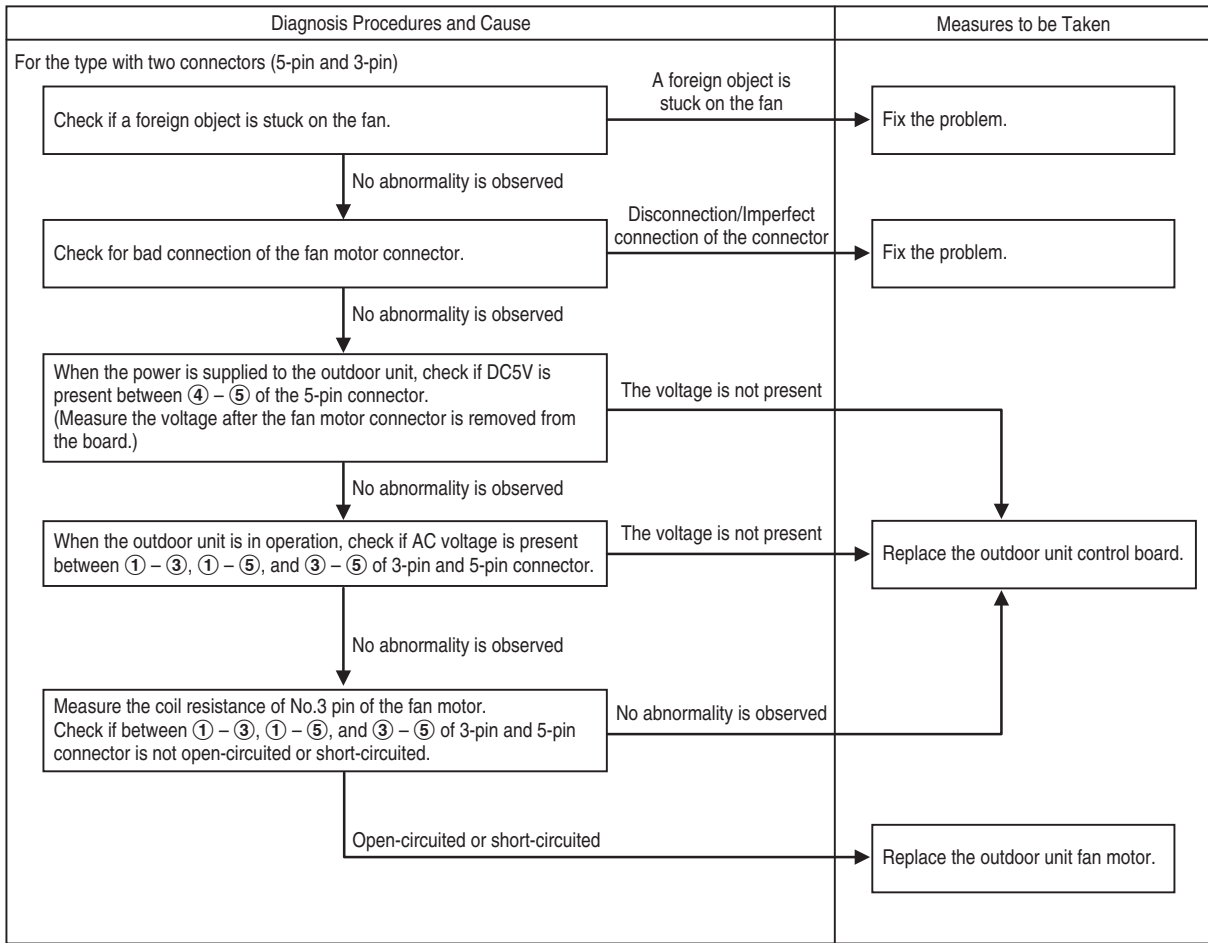

17.4.20 H98 (Indoor Unit Overpressure Protection)

Troubleshooting

Diagnosis Procedures and Cause	Measures to be Taken
<p>Check for clogged filter on the indoor unit.</p> <p style="text-align: right;">An abnormality is observed</p>	<p>Clean the filter.</p>
<p style="text-align: center;">↓ No abnormality is observed</p> <p>Check for bad connection of the connector of indoor unit heat exchanger temperature sensor.</p> <p style="text-align: right;">Disconnection/Imperfect connection of the connector</p>	<p>Fix the problem.</p>
<p style="text-align: center;">↓ No abnormality is observed</p> <p>Check for the characteristics of the indoor unit heat exchanger temperature sensor. ※ Refer to the characteristic table for electronic circuit diagram. (Remove the connector and check the resistance value of the sensor.)</p> <p style="text-align: right;">An abnormality is observed</p>	<p>Replace the indoor unit heat exchanger temperature sensor.</p>
<p style="text-align: center;">↓ No abnormality is observed</p>	<p>Replace the indoor unit control board.</p>
<p>※ For some models, the sensor is not connected by a connector but it is directly soldered to the board. In this case, replace the control board.</p>	

17.4.21 H99 (Indoor Unit Heat Exchanger Freezing Protection (Error Code is to be Stored in the Memory only))

Troubleshooting

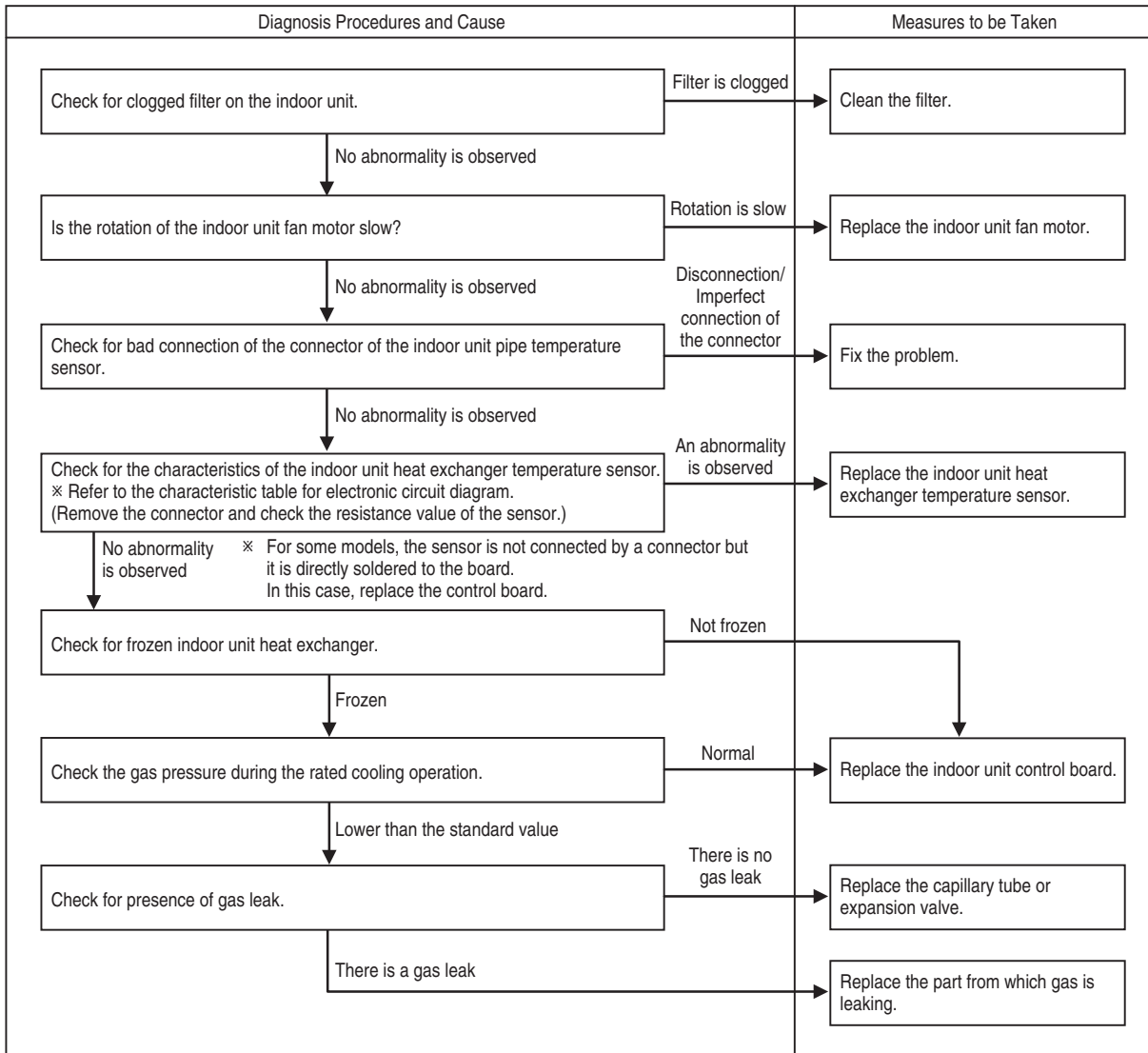

17.4.22 F11 (Cooling-Heating Switching Error)

Troubleshooting

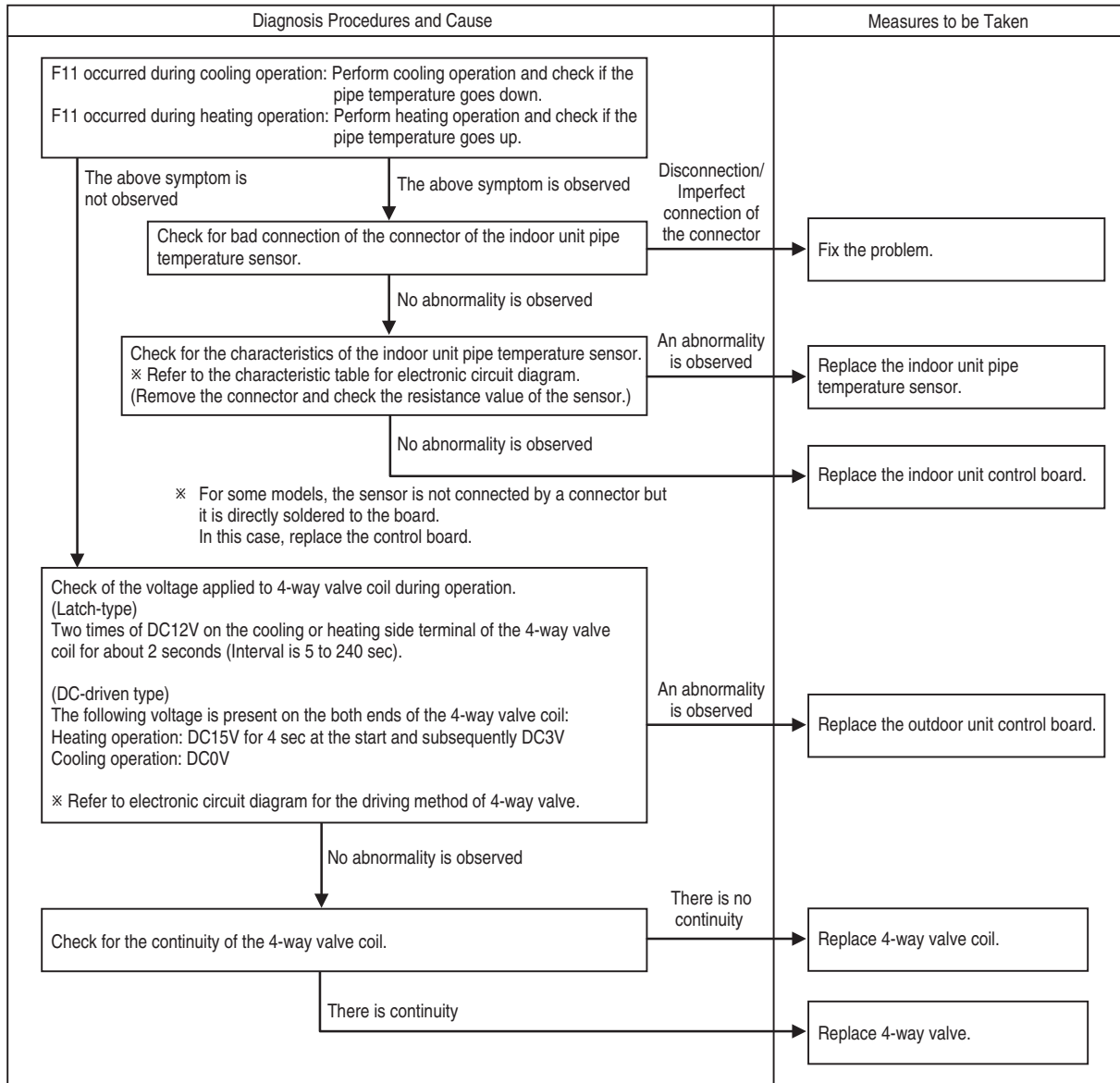

17.4.23 F19 (Aluminium Electric Heater (Heatcharge) Wire Cut Abnormality)

Troubleshooting

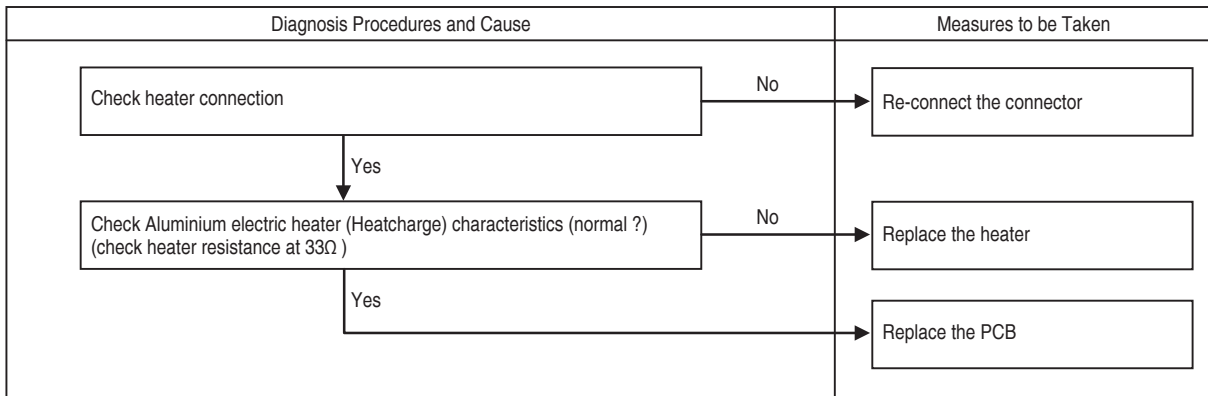

17.4.24 F83 (Protection of Aluminium Electric Heater (Heatcharge) Temperature Over Heating)

Troubleshooting

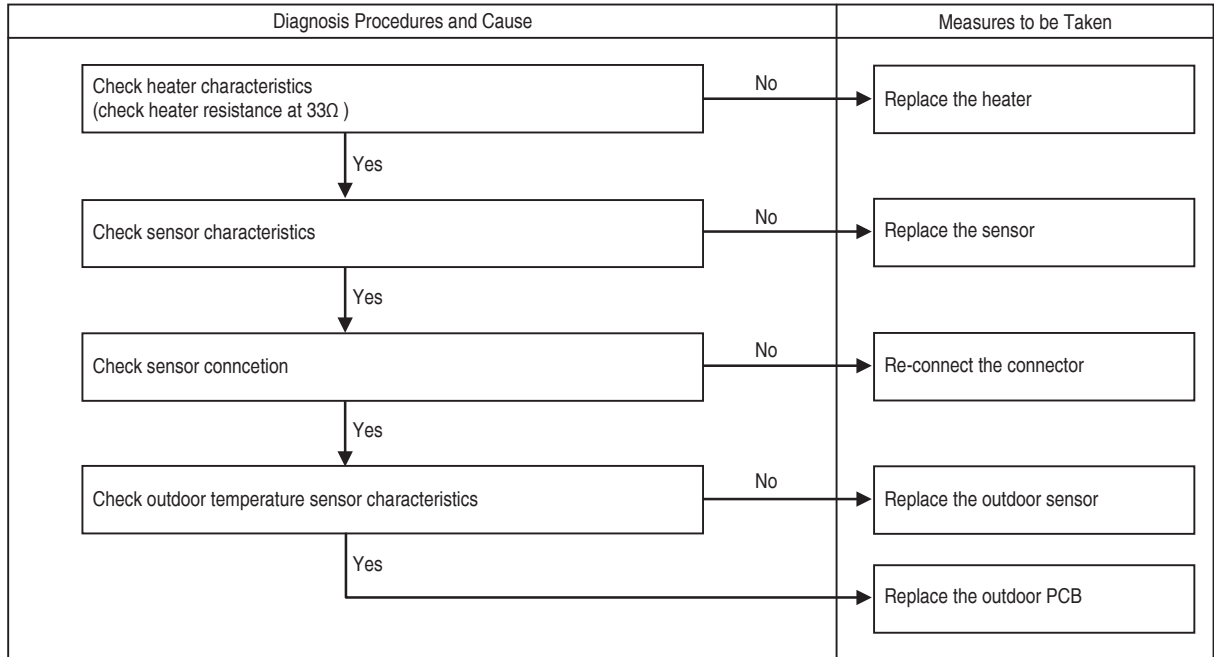

17.4.25 F86 (Aluminium Electric Heater (Heatcharge) 3-Way Valve Cycle Abnormality)

Troubleshooting

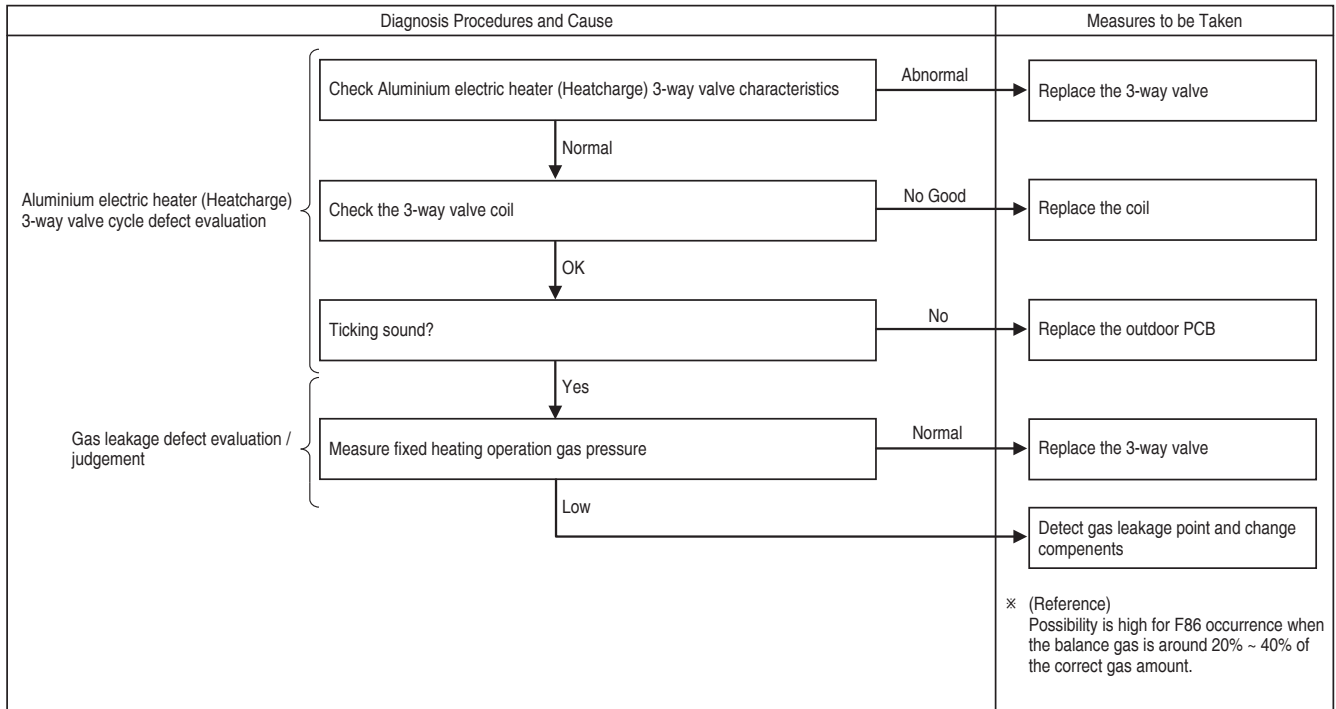

17.4.26 F90 (PFC Protection)

Troubleshooting

Diagnosis Procedures and Cause	Measures to be Taken
<p data-bbox="252 383 882 443">Is PFC protection activated occasionally, or is F90 stored in the memory only?</p> <p data-bbox="555 477 919 506">PFC protection is activated at every operation</p>	<p data-bbox="1086 367 1410 443">PFC protection is activated as a protection against supply voltage drop or instantaneous power interruption.</p> <p data-bbox="1086 499 1401 528">Replace the outdoor unit control board.</p>

17.4.27 F91 (Refrigeration Cycle Error)

Troubleshooting

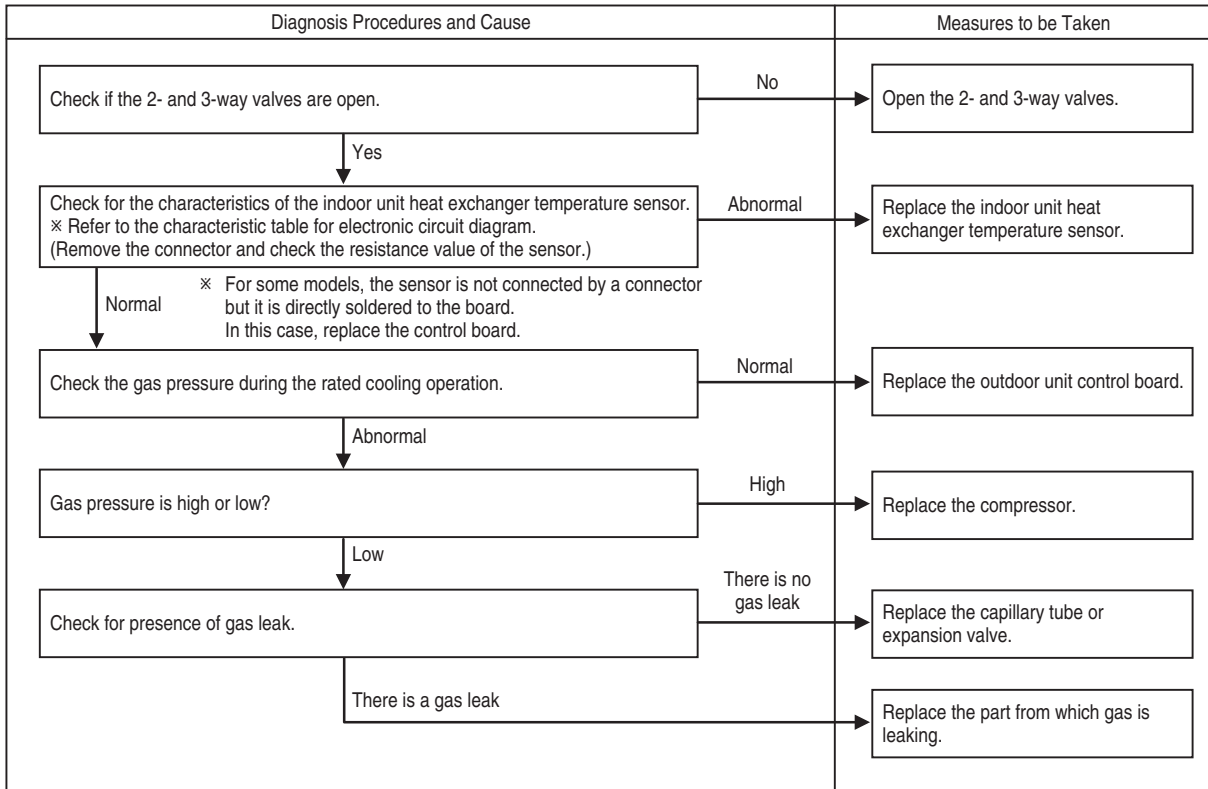

17.4.28 F93 (Compressor Rotation Error)

Troubleshooting

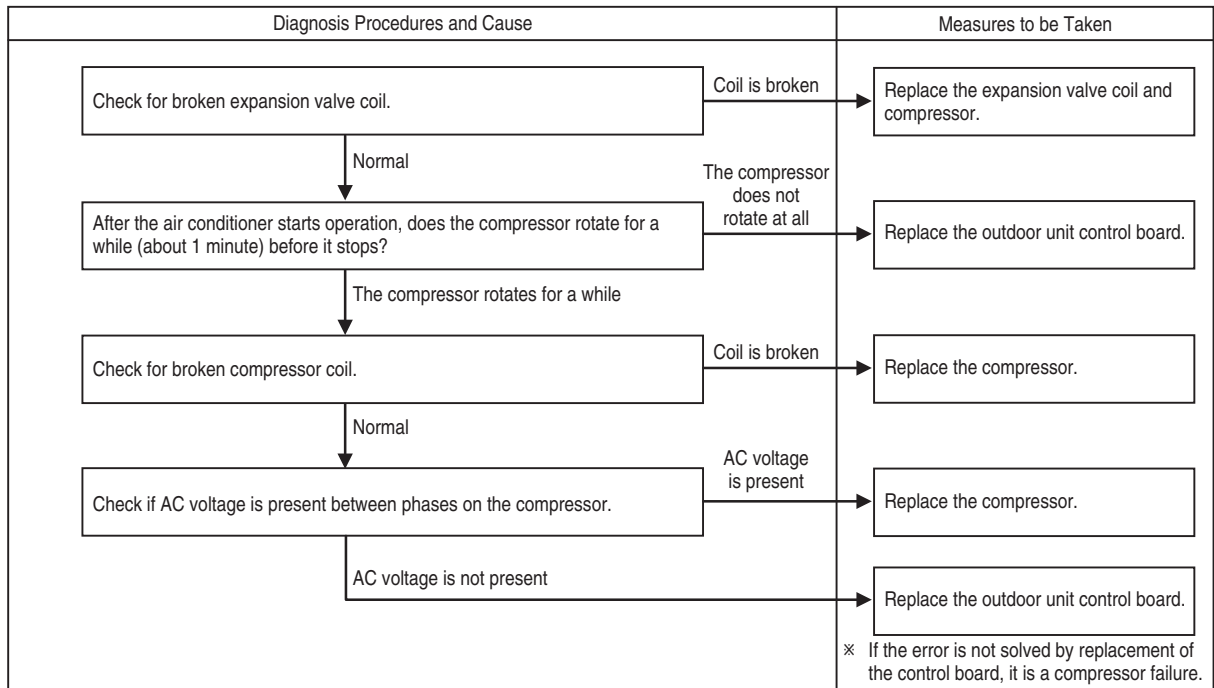

17.4.29 F95 (Overpressure Protection in Case of Cooling Error)

Troubleshooting

Diagnosis Procedures and Cause		Measures to be Taken
<p>Check for clogging and interrupted heat radiation on the outdoor unit heat exchanger.</p>	An abnormality is observed	Fix the problem.
<p>No abnormality is observed</p>		
<p>Check for bad connection of the connector of the outdoor unit heat exchanger temperature sensor.</p>	Disconnection/ Imperfect connection of the connector	Fix the problem.
<p>No abnormality is observed</p>		
<p>Check for the characteristics of the outdoor unit heat exchanger temperature sensor. ※ Refer to the characteristic table for electronic circuit diagram. (Remove the connector and check the resistance value of the sensor.)</p>	An abnormality is observed	Replace the outdoor unit heat exchanger temperature sensor.
<p>No abnormality is observed</p>		Replace the outdoor unit control board.

17.4.30 F96 (Transistor Module Over-temperature Protection)

Troubleshooting

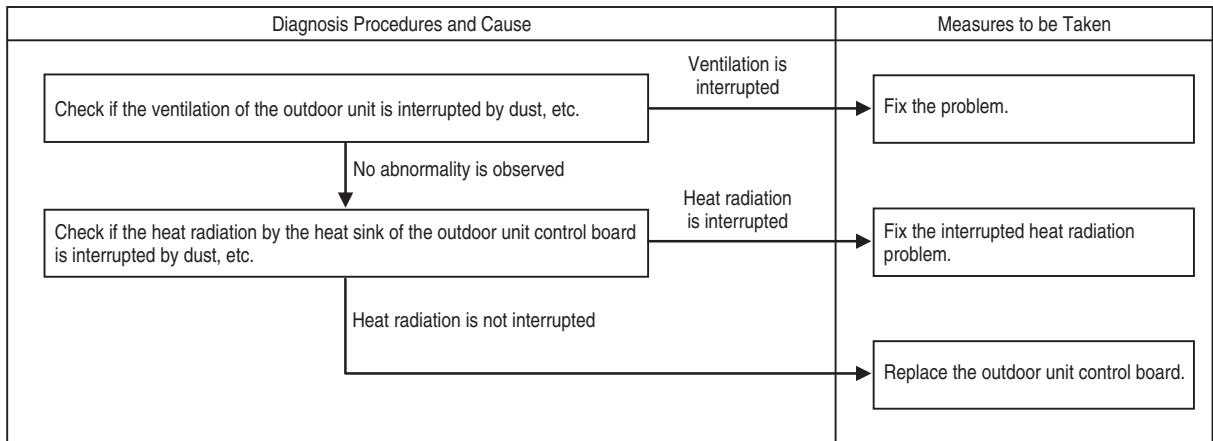

17.4.31 F97 (Compressor Over-temperature Protection)

Troubleshooting

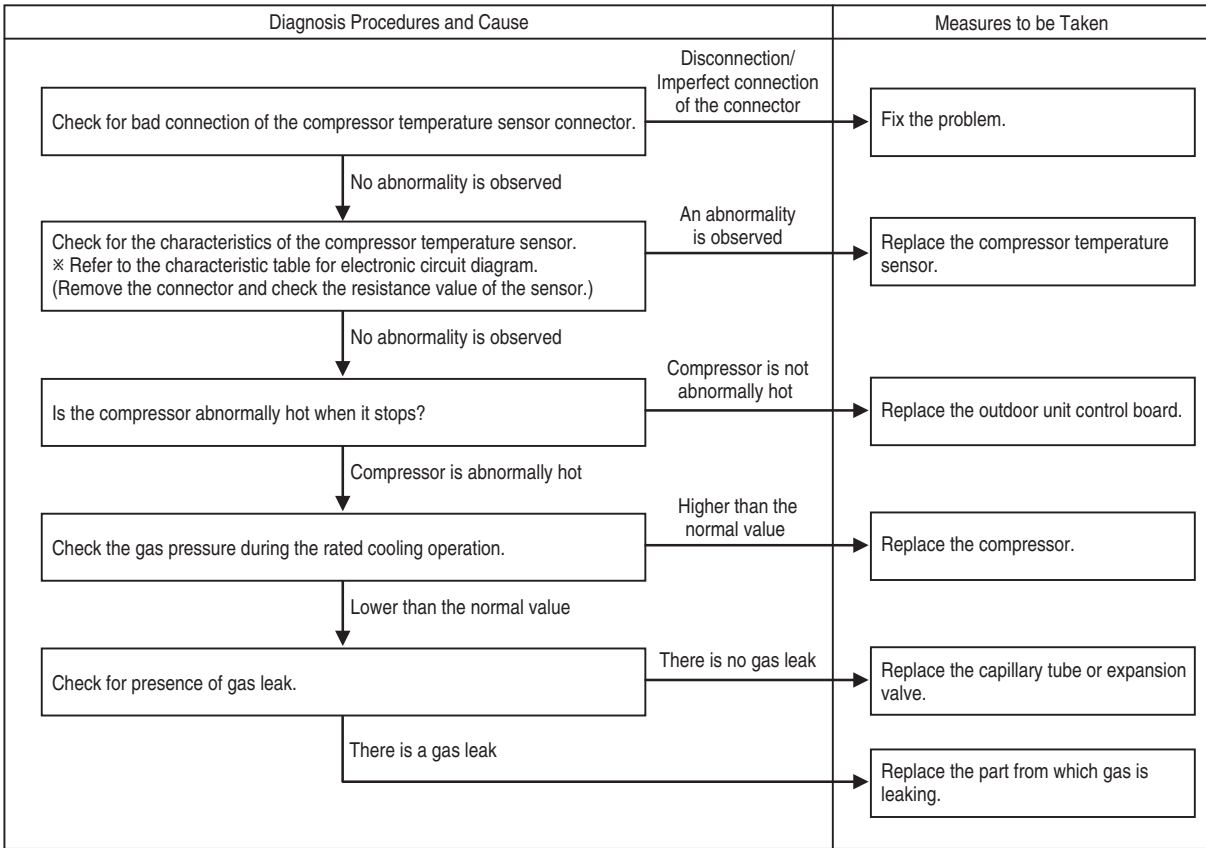

17.4.32 F98 (Total Current Protection Control)

Troubleshooting

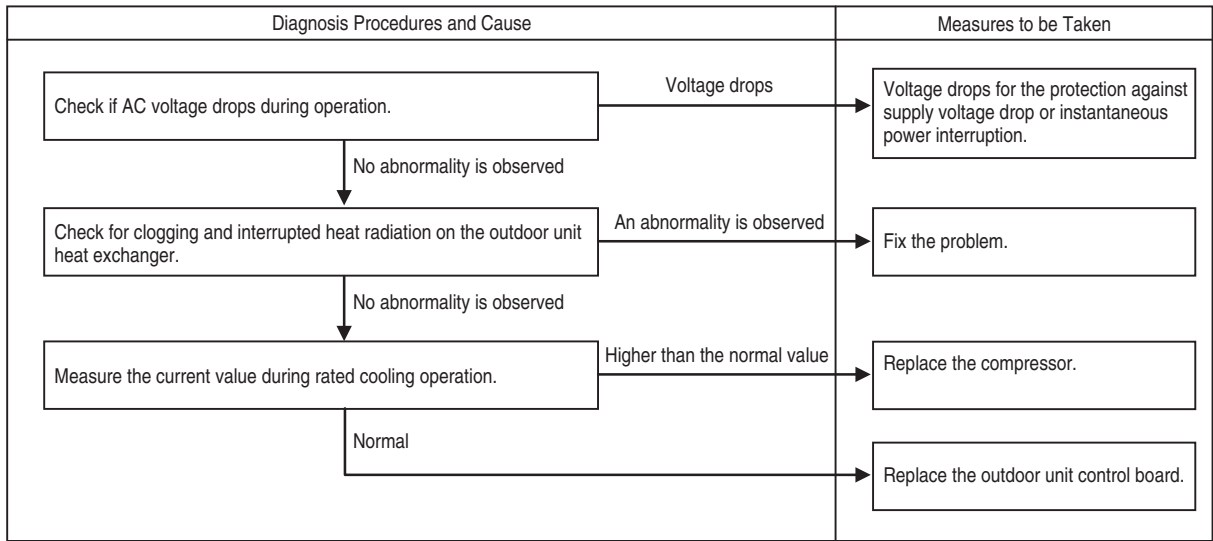

17.4.33 F99 (DC Peak Operation Error)

Troubleshooting

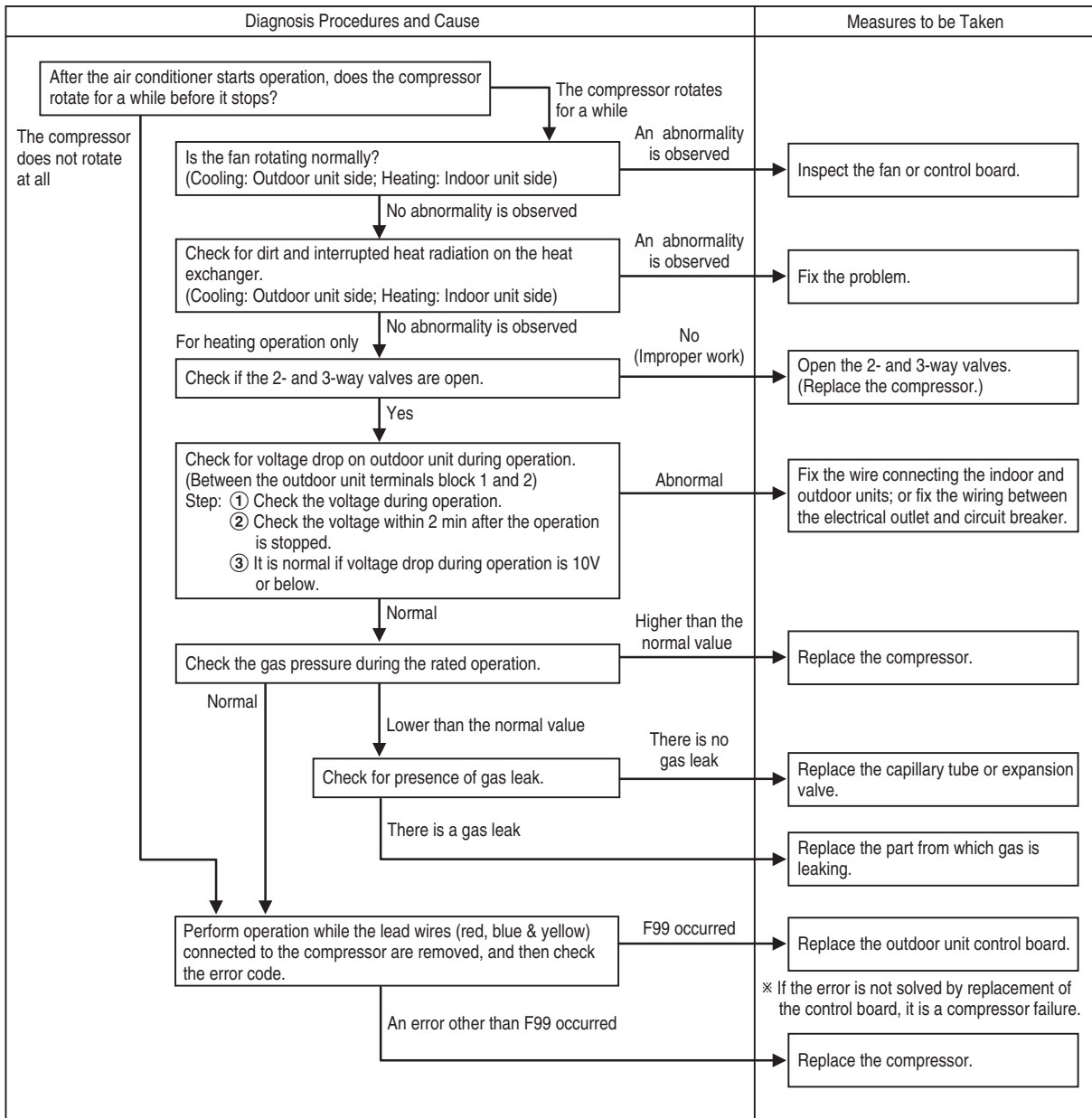

18. Disassembly and Assembly Instructions

18.1 Points of Disassembly (Indoor Unit)



WARNING



Disconnect the power plug

Be sure to disconnect the power plug from the outlet before disassembly or repair of the unit. Failure to observe this warning could result in electric shock. Be very careful not to touch the live parts when performing a repair work which requires power supply or inspecting the circuit. Also, be very careful of the fan as it can start rotating anytime.

Read this manual carefully when replacing the air filter frame (auto cleaner) block or other parts.

18.1.1 Removing the Front Panel

- 1 Push the panel up with both hands until it stops. Push the panel further up and then pull it towards you to remove it.
※ Note on disassembly: Hold the grooves on the front panel to open it. (The panel moves if you hold the movable part.)

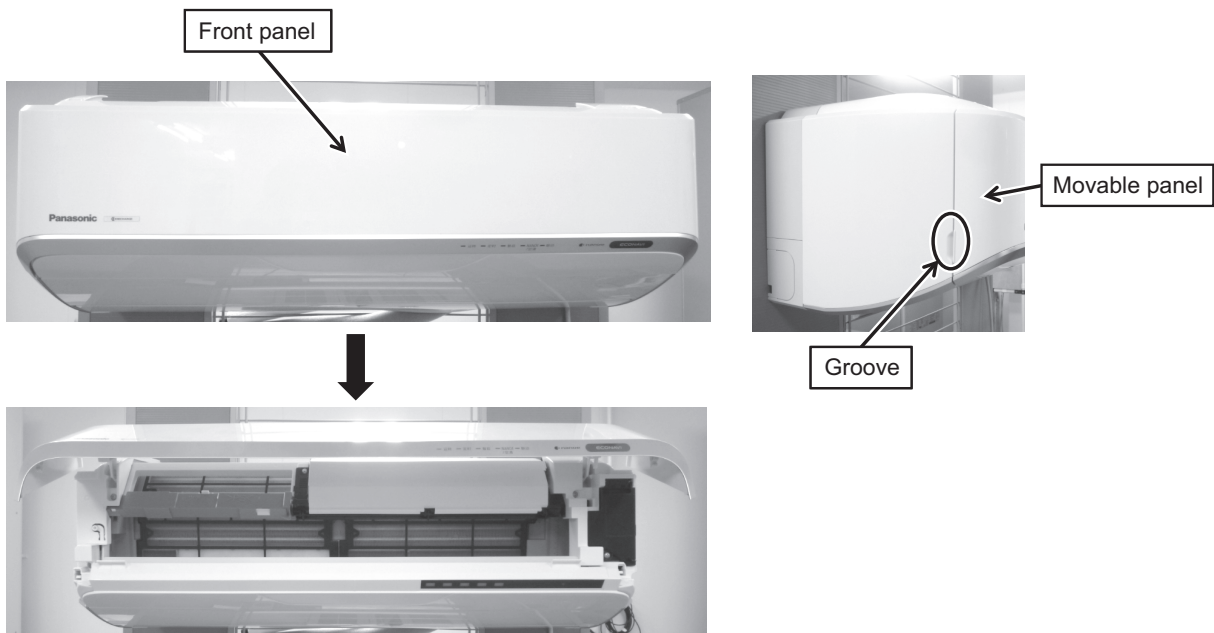

18.1.2 Removing the Air Filters

- 1 Raise the front panel up with both hands until it stops.
* Note on disassembly: Hold the grooves on the front panel to open it. (The panel moves if you hold the movable part).
 - 2 Pull down the receiver and indicator panel.
 - 3 Put your fingers at the slits on both sides of the air filter and pull the filter towards you to remove it. (Left and right filters are common).
- * Note on disassembly: The air filters are in L shape which cover up to the inner end of the stop side. Pull the filters slowly towards you to avoid them from getting stuck.

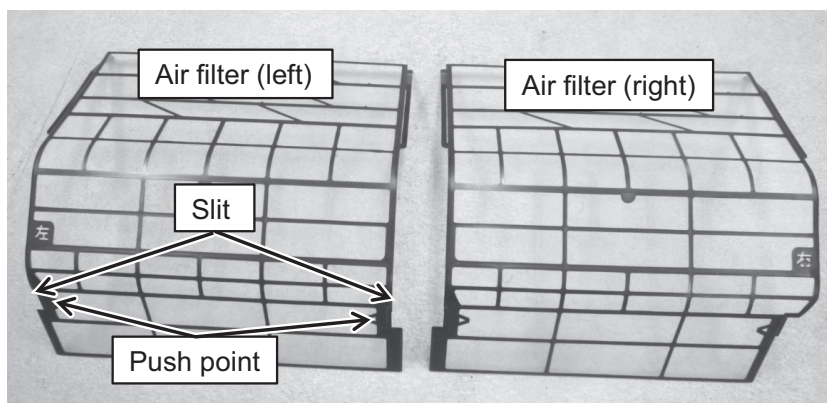
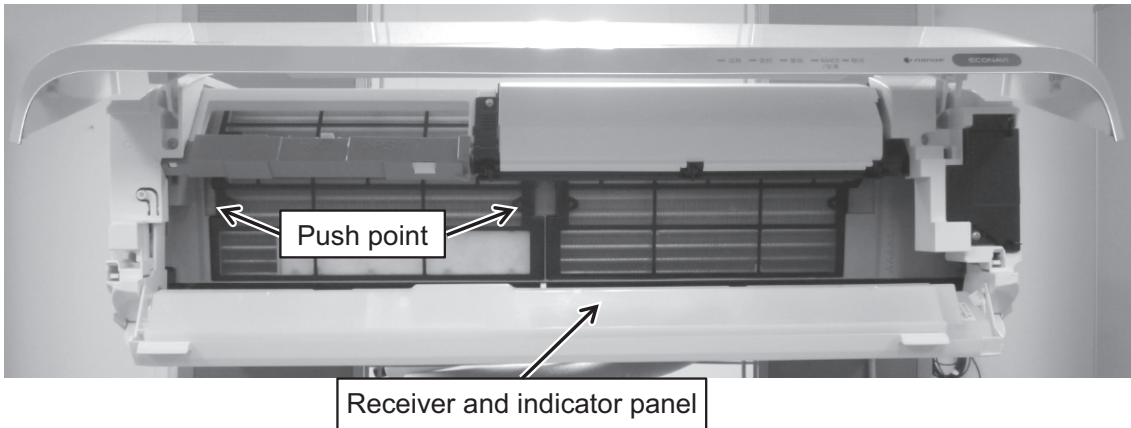

※ Note on assembly: When attaching the air filters, push the push point on the air filters securely and make sure that there is no misalignment of the filters such as lifted filter.

18.1.3 Removing the Front Grille (Right) and Front Grille (Left)

- 1 Perform "18.1.1 Removing the Front Panel".
- 2 Pull down the receiver and indicator panel.

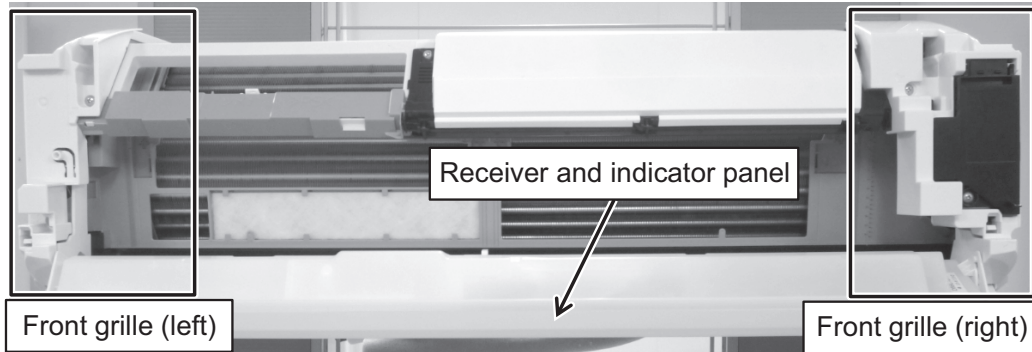

- 3 Open the vertical airflow direction louver slowly.

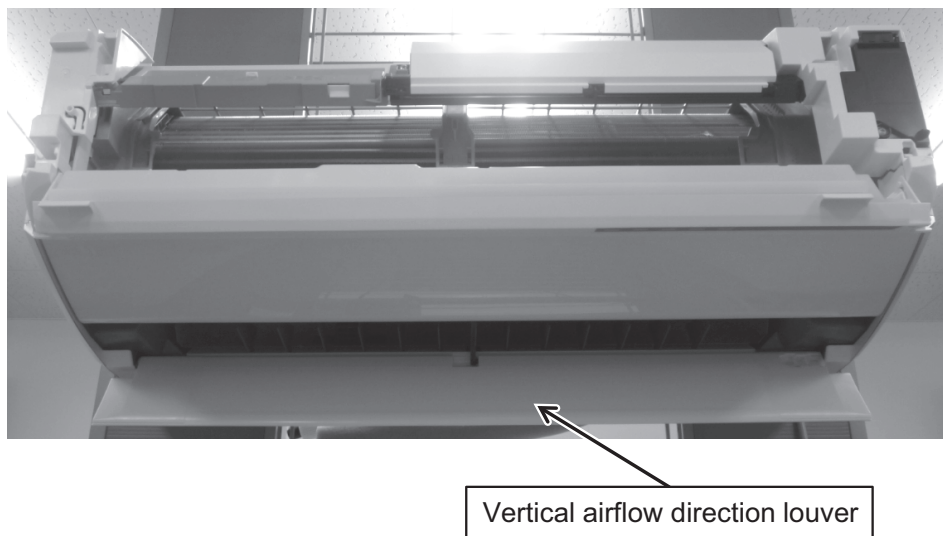

- 4 Remove the screw of the front grille (right) and (left) (2 screws each).
- 5 Disengage the tab on the top part of the front grille (right) and (left) (one tab each). Slightly lift the top part and then raise the front grilles to remove them.

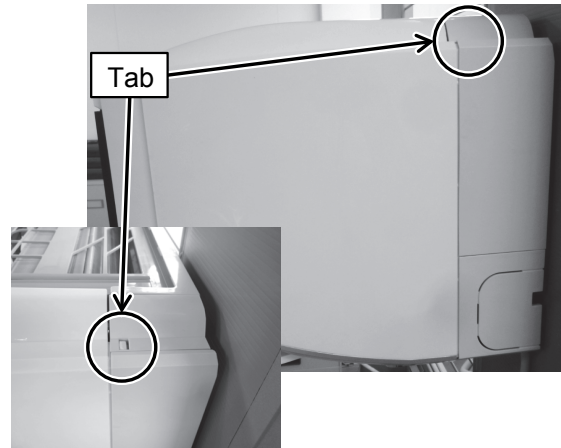
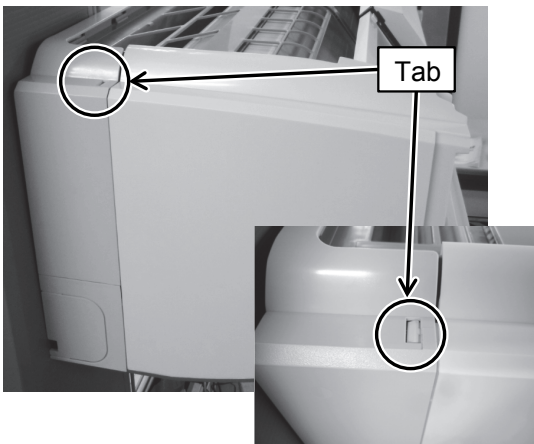
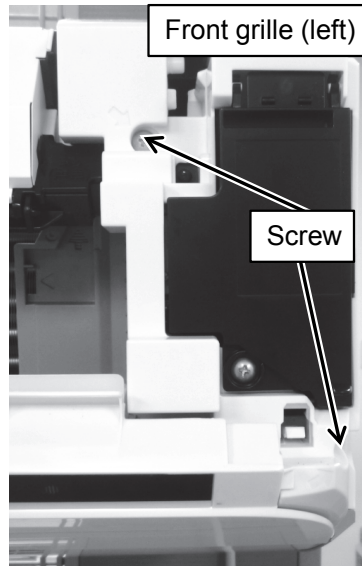
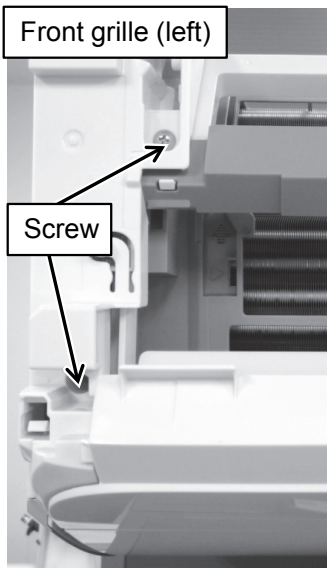

18.1.4 Removing the Control Board (Electronic Controller)

- 1 Perform "18.1.1 Removing the Front Panel".
- 2 Perform "18.1.3 Removing the Front Grille (Right) and Front Grille (Left)".
* Note on disassembly: When removing only the control board box, remove the front grille (right) only.
- 3 Remove the screw (2 pieces) at the control board cover.
- 4 Disengage the tab at the control board cover (2 tab).
- 5 Pull down the electrical component cover (front) on the control board box.

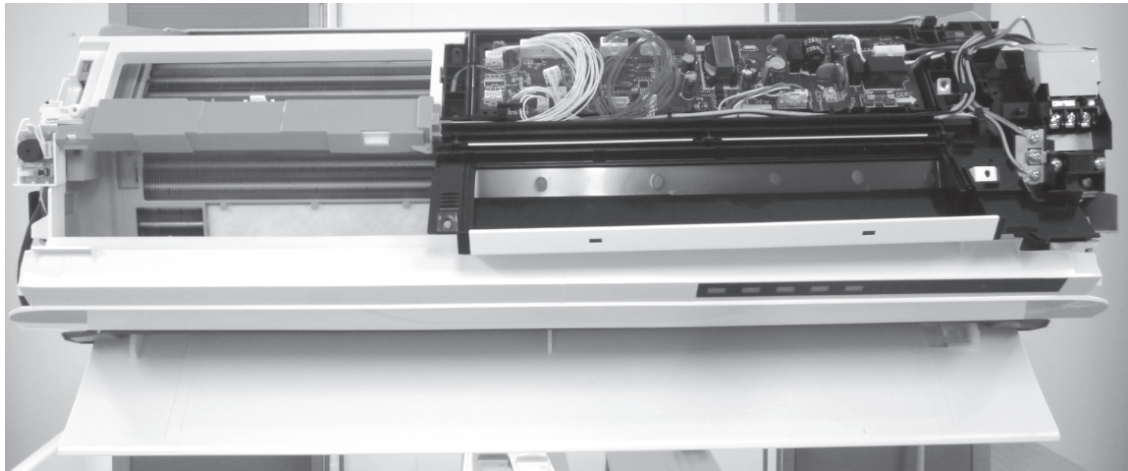
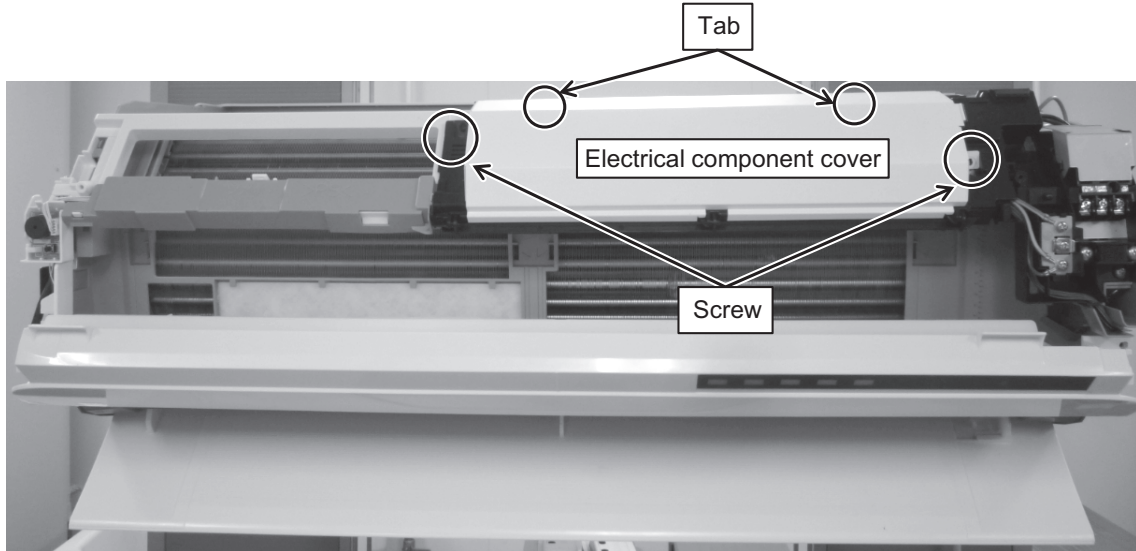

Disconnect the connectors and terminals.

■ Connectors

- CN-GEAR1 (white).....Horizontal louver motor (left), Vertical louver motor (up left) and Vertical louver motor (down).
- CN-GEAR2 (white).....Vertical louver motor (up right) and Horizontal louver motor (right).
- CN-CNT (white)
- CN-NANO (white).....High voltage power supply (nanoe)
- CN-TH1 (yellow).....Indoor heat exchanger temperature sensor.
- CN-TH2 (green).....Indoor air temperature sensor.
- CN-FM (white).....Indoor fan motor.
- CN-DISP (white).....Control board (Indicator, signal receptor and human sensor).
- CN-PNL (white).....Front panel switch.
- CN-SW (blue).....Control board (Auto OFF/ON button).

■ Tab terminals

- TAB1 (brown).....Power supply.
- TAB2 (white).....Power supply (Thermal fuse).

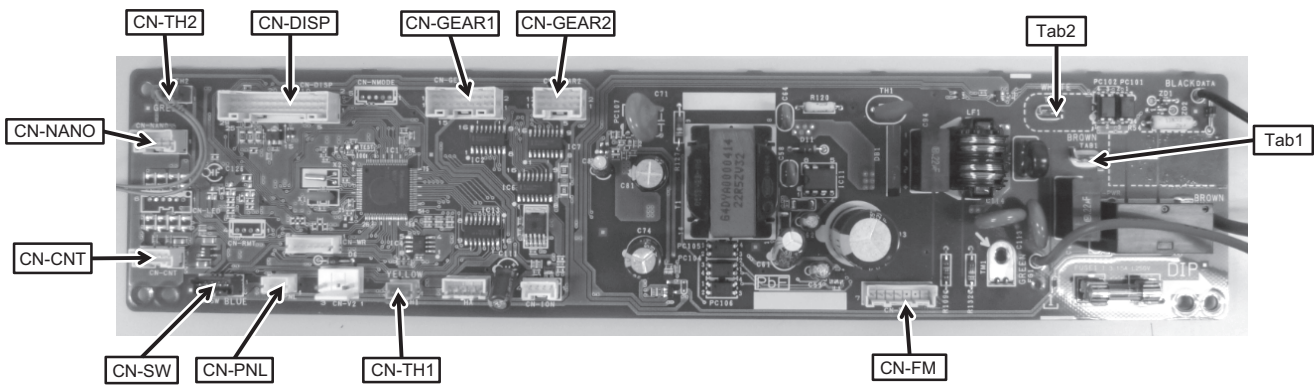

- 6 Remove terminal block cover and disconnect terminal lead wire (brown and black) and remove earth wire screw (1 piece).
- 7 Remove the screw at the control board and disengage the tab (2 locations) on both sides of the control board. Then remove the control board.

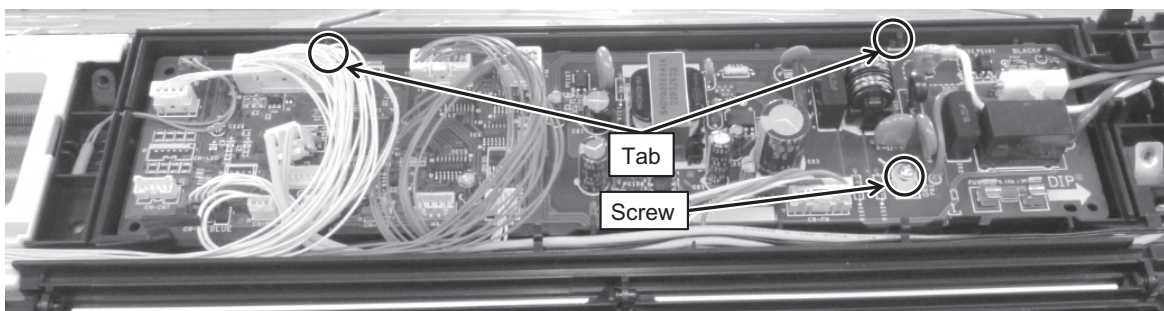
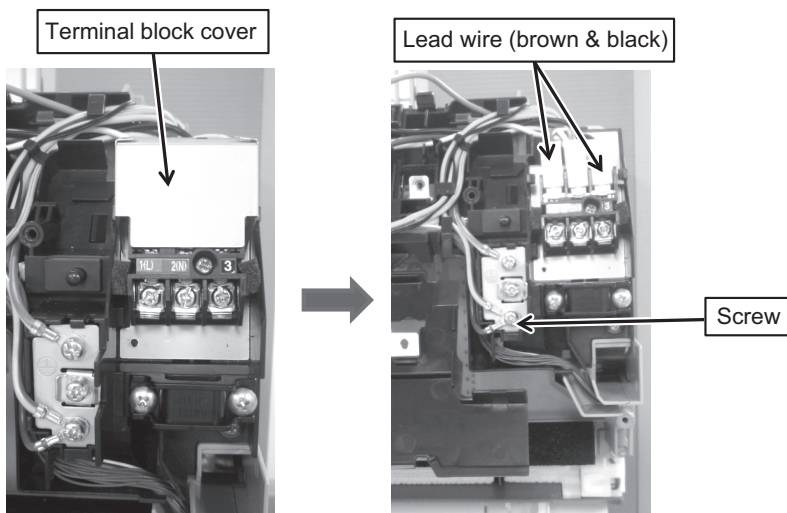

18.1.5 Removing the Control Board (Auto OFF/ON Button)

- 1 Perform "18.1.1 Removing the Front Panel".
- 2 Perform "18.1.3 Removing the Front Grille (Right) and Front Grille (Left)".
* Note on disassembly: When removing only the control board (Auto OFF/ON button), remove the front grille (left) only.
- 3 Remove lead wire casing. (There are 3 tabs at the casing).
- 4 Disconnect connector CN-SW (white).....Control board (Auto OFF/ON button).
- 5 Disengage the tab (2 locations) on both sides of the control board. Then, remove the control board from casing.

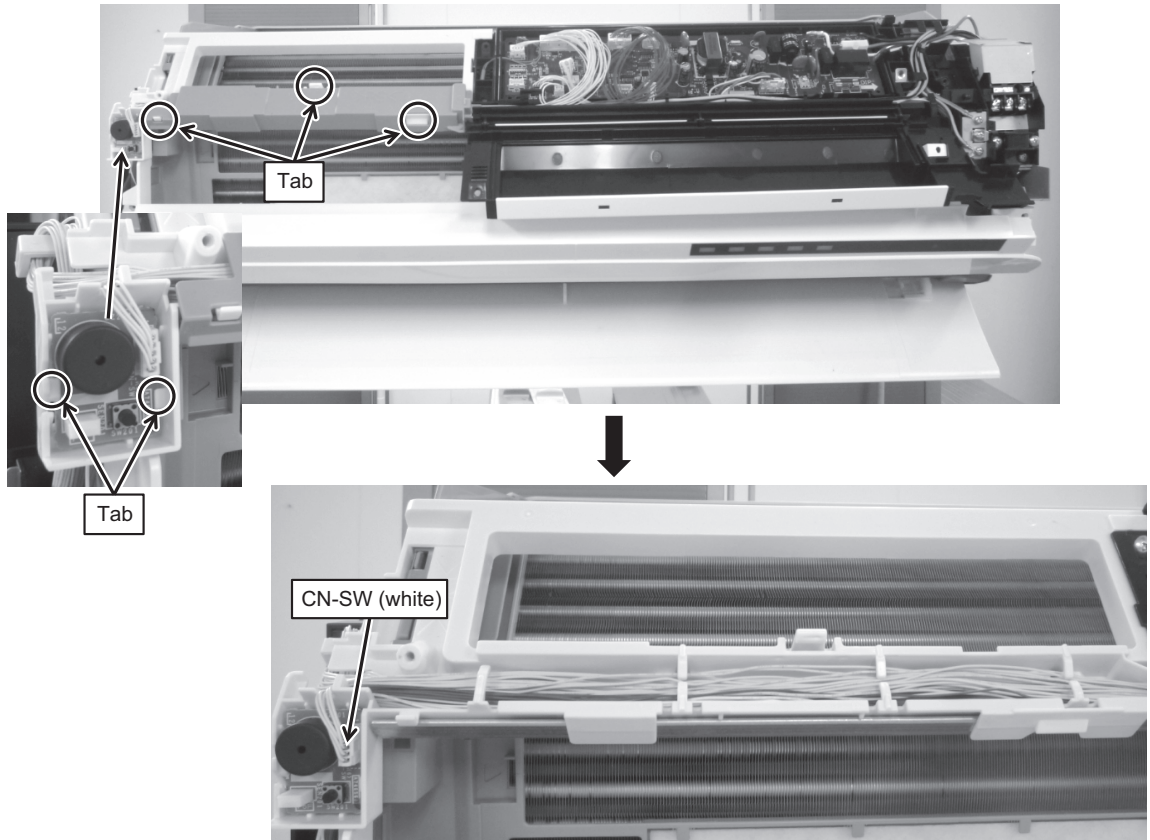

18.1.6 Removing the Indicator, Receiver & Human Sensor Control Board

- 1 Perform "18.1.1 Removing the Front Panel".
- 2 Pull down the receiver and indicator panel.
- 3 Remove the screw (2 pieces) and disengage the tab (2 locations) on both sides of the control board and 1 tab on the center of control board.

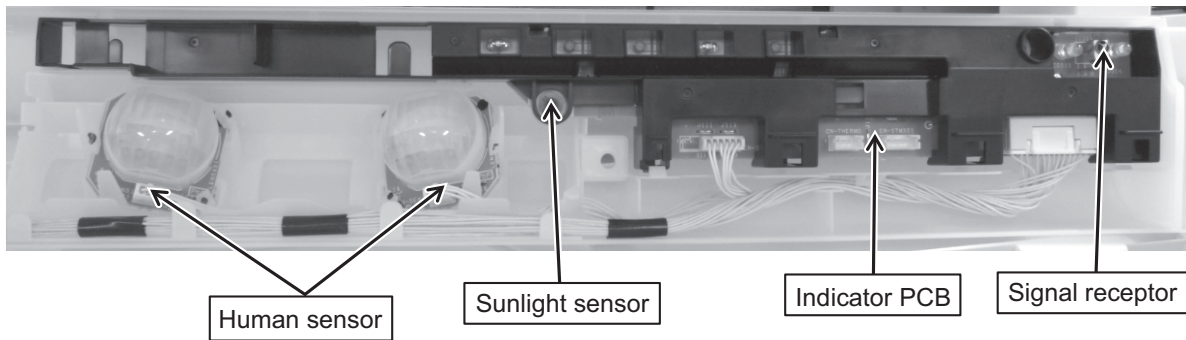
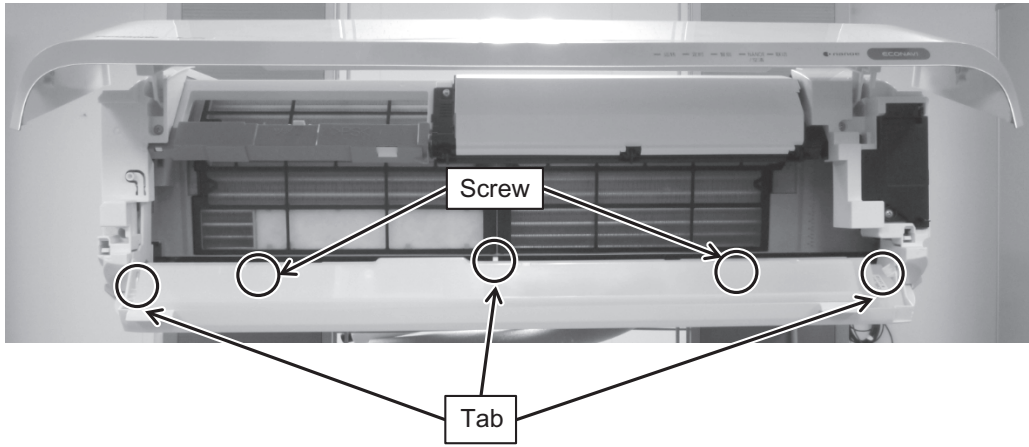

■ How to remove the human sensor

- 1 Disconnect connector CN-SENS1 (white).....Human sensor .
- 2 Remove the human sensor from casing. (each unit have 2 tabs at the casing).

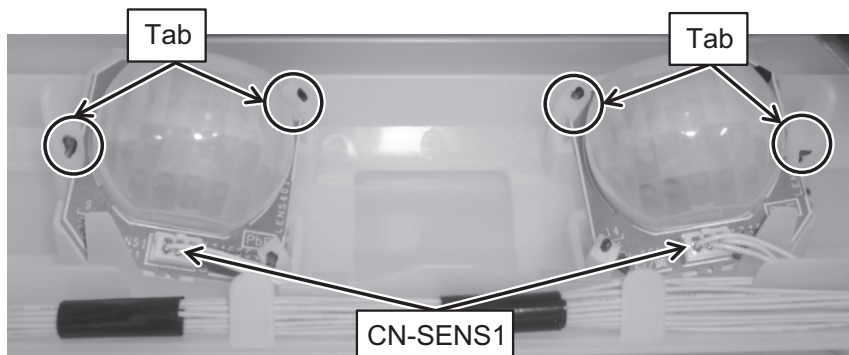

Note: There is 3 human sensor for model CS-VE18KK1 and CS-VE22KK1.

■ How to remove control board (indicator and signal receptor)

- 1 Disconnect connector CN-DISP (white)....Control board.....and CN-SENS (white).....Human sensor.
- 2 Disengage the tabs (1 location on the plastic indicator cover).

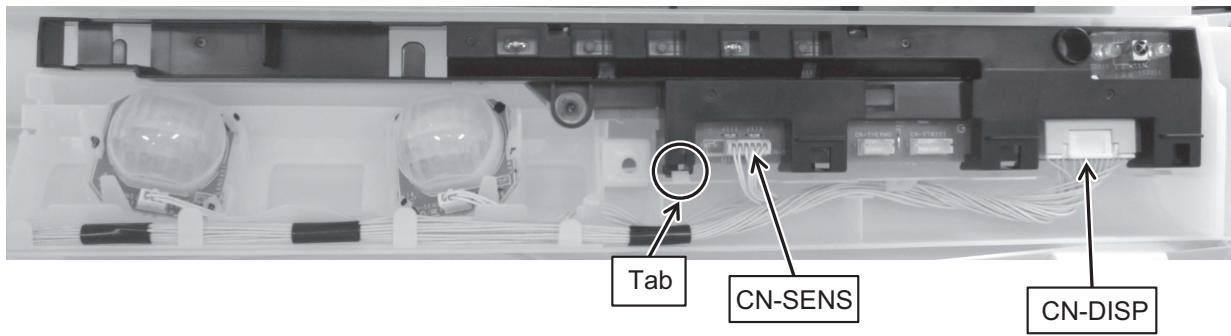

- 3 Flip the plastic indicator cover and disengage the tabs. (4 locations).

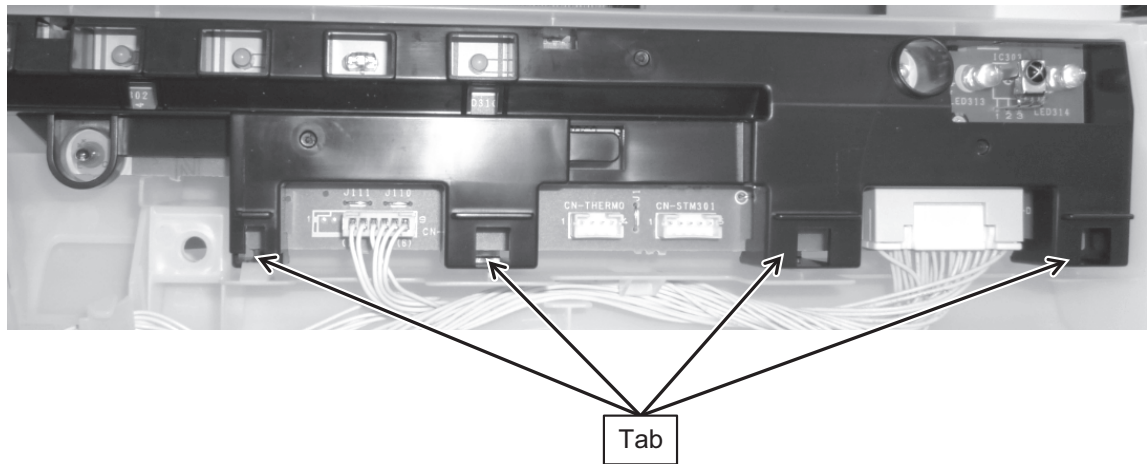

18.1.7 Removing the Vertical Airflow Direction Louver

■ How to remove the lower louver of the vertical airflow direction louver.

- 1 Open the lower louver
- 2 The back side of the lower louver is designed as follows:
 - left - inserting type
 - center - hook engaging type
 - right - inserting into the motor with push-pull lock
- 3 Push the center hook to the left to disengage it.
- 4 Unlock the right shaft by push to right and pull back to left side and warp the center part of the lower louver towards you and then pull out the left shaft. Then, remove the lower louver.

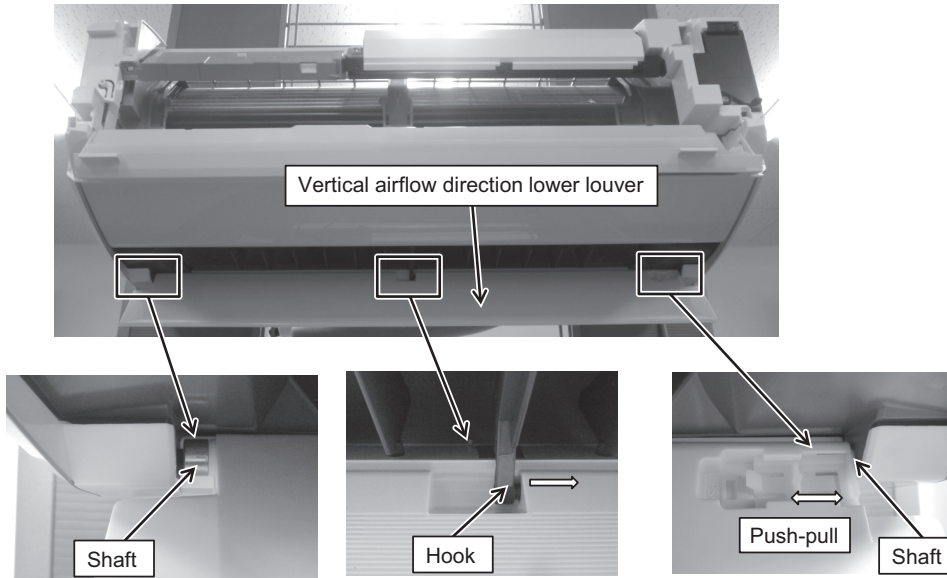

■ How to remove the upper louver of the vertical airflow direction louver.

- 1 Open the lower louver and then open the upper louver.

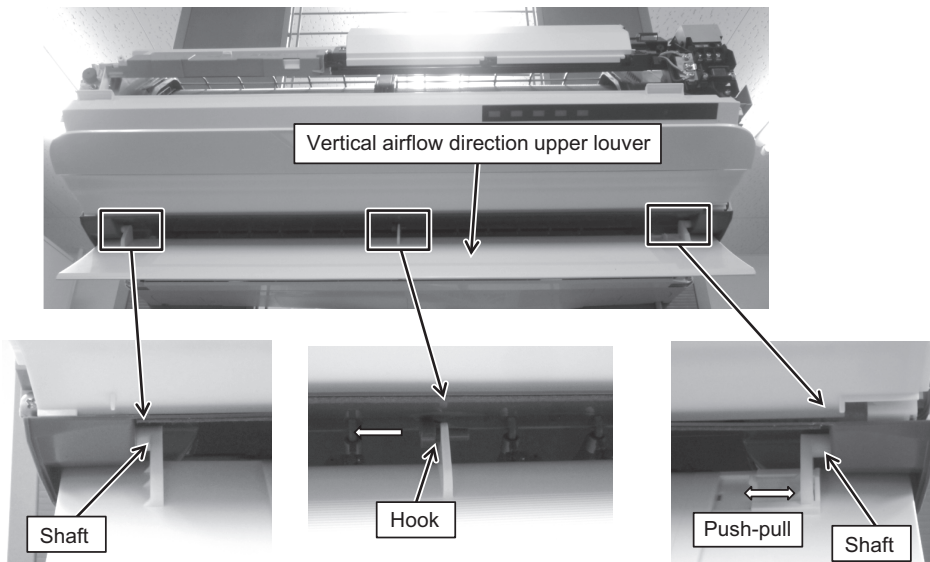

- 2 The back side of the lower louver is designed as follows:

- left - inserting type
- center - hook engaging type
- right - inserting into the motor with push-pull lock

- 3 Push the center hook to the left to disengage it.
- 4 Unlock the right shaft by push to right and pull back to left side and warp the center part of the lower louver towards you and then pull out the left shaft. Then, remove the lower louver.

For details: Please refer steps to remove the vertical airflow direction louver.

18.1.8 Removing the Indicator, Receiver & Human Sensor Control Board to below side

- 1 Perform "18.1.1 Removing the Front Panel".
- 2 Perform "18.1.2 Removing the Air Filters".
- 3 Perform "18.1.3 Removing the Front Grille (Right) and Front Grille (Left)".
- 4 Disengage the tabs (2 locations) located at indicator, receiver and human sensor control board. Then, Pull down the indicator, receiver and human sensor control board.

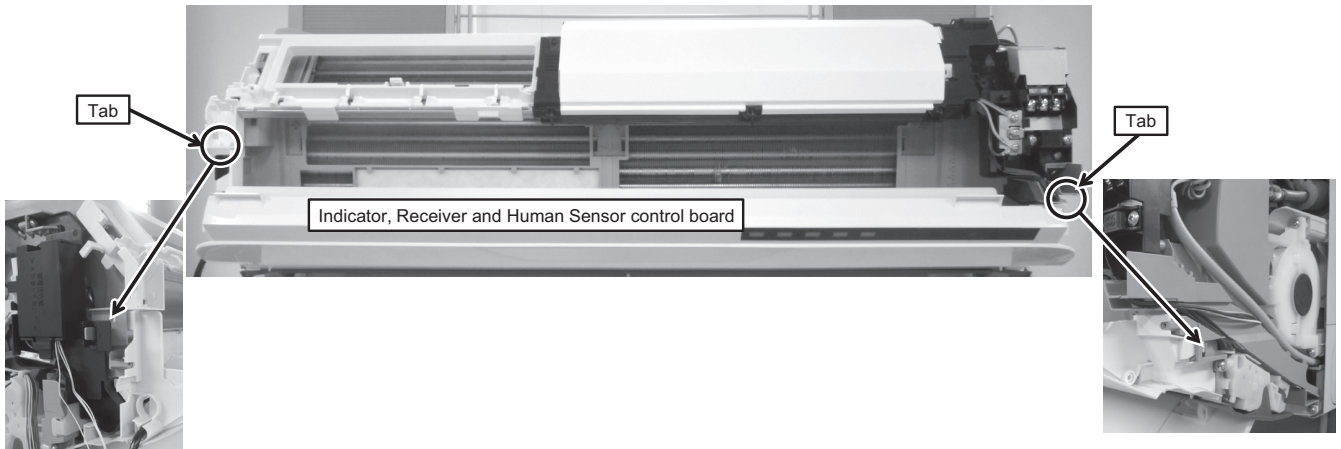

18.1.9 Removing the Indicator, Receiver & Human Sensor Control Board from unit

- 1 Perform "18.1.1 Removing the Front Panel".
- 2 Perform "18.1.2 Removing the Air Filters".
- 3 Perform "18.1.3 Removing the Front Grille (Right) and Front Grille (Left)".
- 4 Perform "18.1.6 Removing the Indicator, Receiver & Human Sensor Control Board".
 - * Note on disassembly: When removing the Indicator, Receiver & Human Sensor Control Board from unit, disconnect connector CN-DISP (white) only.
- 5 Perform "18.1.8 Removing the Indicator, Receiver & Human Sensor Control Board to below side".
- 6 Push the hook (2 hook) to the front to disengage it.

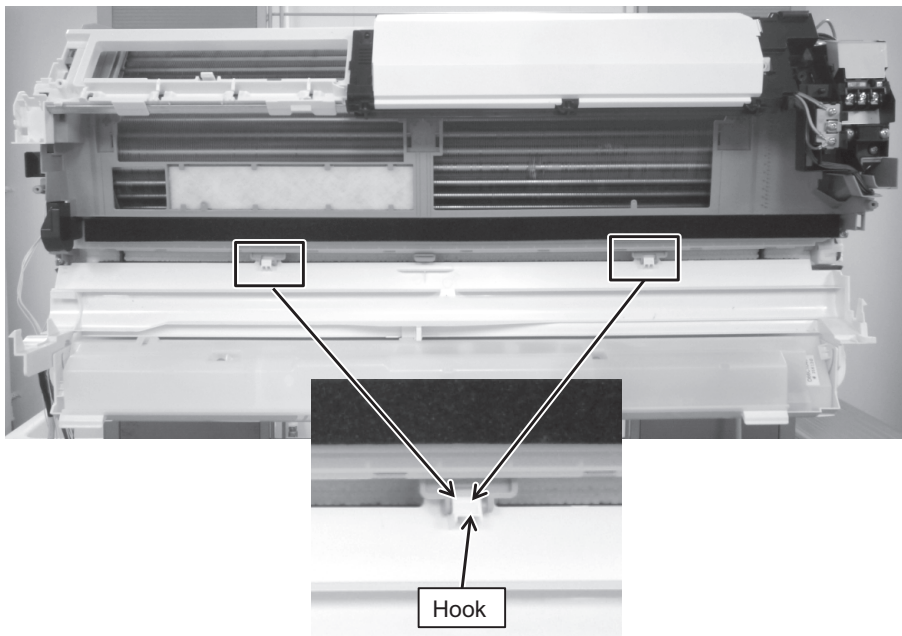

18.1.10 Removing the Electronic Controller Box and Bracket

- 1 Perform "18.1.1 Removing the Front Panel".
- 2 Perform "18.1.2 Removing the Air Filters".
- 3 Perform "18.1.3 Removing the Front Grille (Right) and Front Grille (Left)".
- 4 Perform "18.1.4 Removing the Control Board (Electronic Controller)".
- 5 Remove the screws (1 piece) located at terminal block casing. Then, remove the electronic controller box and bracket.

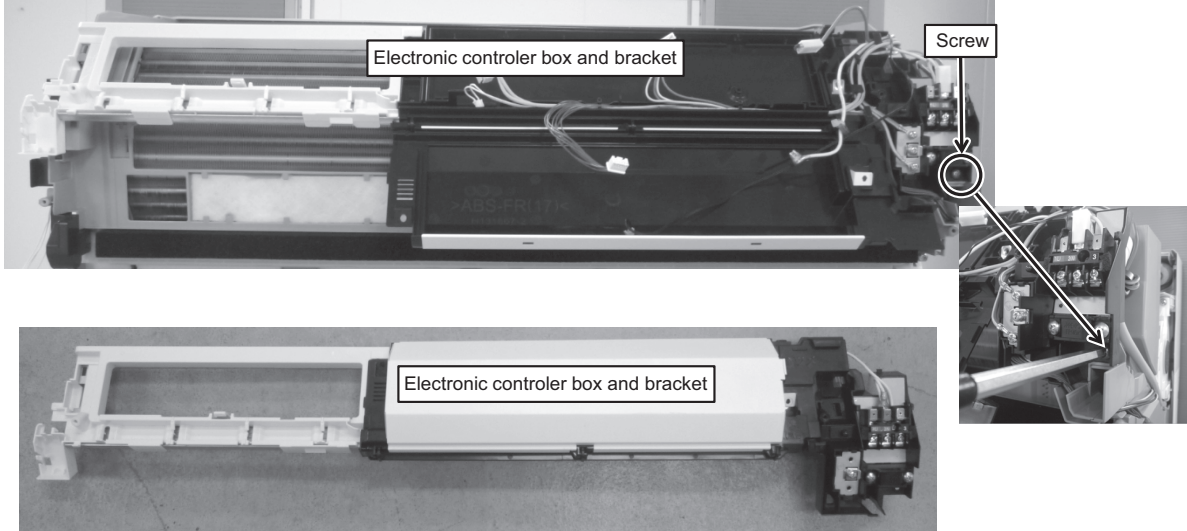

18.1.11 Removing the nanoe Controller Box

- 1 Perform "18.1.1 Removing the Front Panel".
- 2 Perform "18.1.2 Removing the Air Filters".
- 3 Perform "18.1.3 Removing the Front Grille (Right) and Front Grille (Left)".
- 4 Perform "18.1.4 Removing the Control Board (Electronic Controller)".
- 5 Perform "18.1.8 Removing the Indicator, Receiver & Human Sensor Control Board to below side".
- 6 Perform "18.1.10 Removing the Electronic Controller Box and Bracket".
- 7 Disconnect 2 connector (white and green).
- 8 Remove the screw (1 piece) and disengage the tab (1 location) located at nanoe control board.

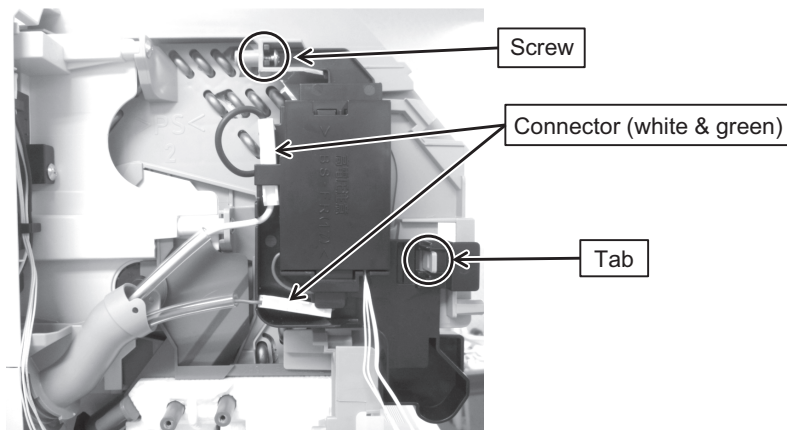

18.1.12 Removing the Drive Motor of the Vertical and Horizontal Direction Louver (Left side)

- 1 Perform "18.1.1 Removing the Front Panel".
- 2 Perform "18.1.2 Removing the Air Filters".
- 3 Perform "18.1.3 Removing the Front Grille (Right) and Front Grille (Left)".
- 4 Perform "18.1.4 Removing the Control Board (Electronic Controller)".
- 5 Perform "18.1.8 Removing the Indicator, Receiver & Human Sensor Control Board to below side".
- 6 Perform "18.1.9 Removing the Indicator, Receiver & Human Sensor Control Board from unit".
- 7 Perform "18.1.10 Removing the Electronic Controller Box and Bracket".
- 8 Release the lever from the horizontal louver.
- 9 Remove the screws (4 pieces) from the drive motor complete and remove it from unit.

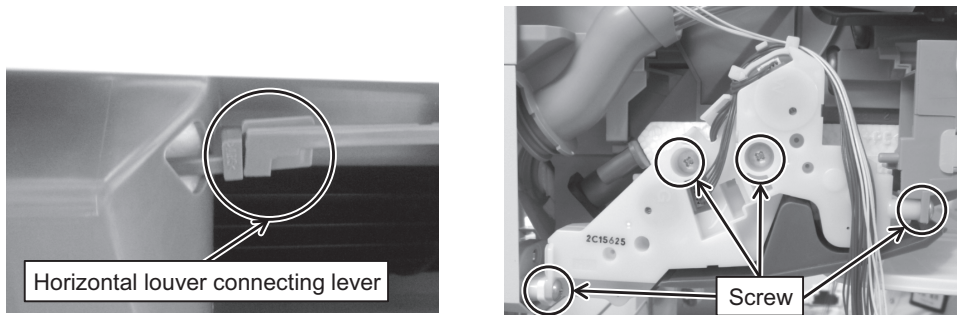

18.1.13 Removing the Front Grille Bracket (Frame - Air Filter)

- 1 Perform "18.1.1 Removing the Front Panel".
- 2 Perform "18.1.2 Removing the Air Filters".
- 3 Perform "18.1.3 Removing the Front Grille (Right) and Front Grille (Left)".
- 4 Perform "18.1.4 Removing the Control Board (Electronic Controller)".
- 5 Perform "18.1.8 Removing the Indicator, Receiver & Human Sensor Control Board to below side".
- 6 Perform "18.1.9 Removing the Indicator, Receiver & Human Sensor Control Board from unit".
- 7 Perform "18.1.10 Removing the Electronic Controller Box and Bracket".
- 8 Perform "18.1.11 Removing the nanoe Controller Box".
- 9 Remove the screws (4 pieces) of the front grille panel and remove it from unit.

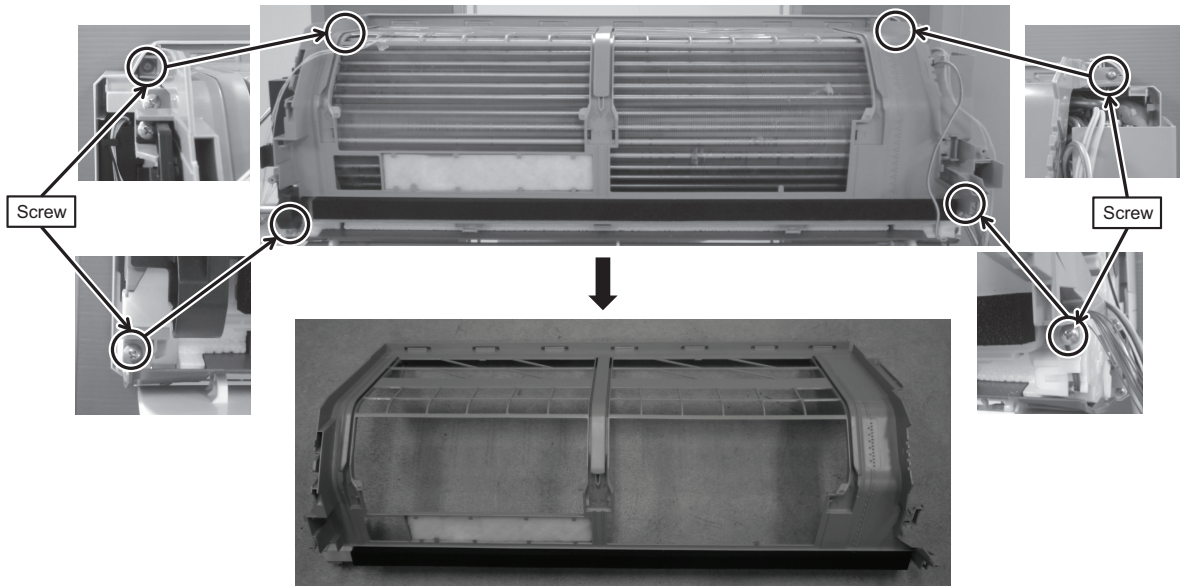

18.1.14 Removing the Drive Motor of the Vertical and Horizontal Direction Louver (right side)

- 1 Perform "18.1.1 Removing the Front Panel".
- 2 Perform "18.1.2 Removing the Air Filters".
- 3 Perform "18.1.3 Removing the Front Grille (Right) and Front Grille (Left)".
- 4 Perform "18.1.4 Removing the Control Board (Electronic Controller)".
- 5 Perform "18.1.8 Removing the Indicator, Receiver & Human Sensor Control Board to below side".
- 6 Perform "18.1.9 Removing the Indicator, Receiver & Human Sensor Control Board from unit".
- 7 Perform "18.1.10 Removing the Electronic Controller Box and Bracket".
- 8 Perform "18.1.11 Removing the nanoe Controller Box".
- 9 Perform "18.1.13 Removing the Front Grille bracket (Frame - Air Filter)".
- 10 Remove the fan motor cover.

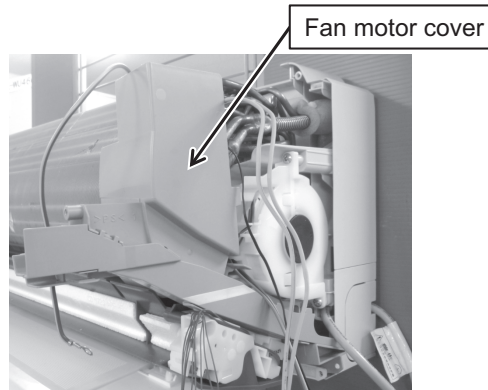

- 11 Remove the screws (2 pieces) from the drive motor complete and remove it from discharge grille.

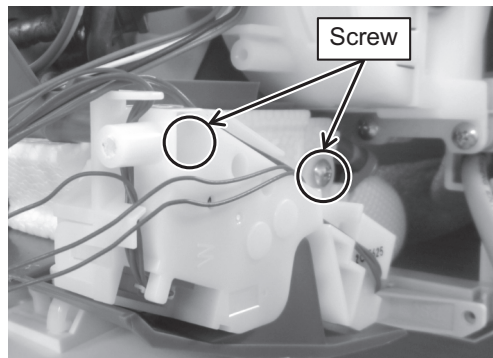

18.1.15 Removing the Discharge Grille

- 1 Perform "18.1.1 Removing the Front Panel".
- 2 Perform "18.1.2 Removing the Air Filters".
- 3 Perform "18.1.3 Removing the Front Grille (Right) and Front Grille (Left)".
- 4 Perform "18.1.4 Removing the Control Board (Electronic Controller)".
- 5 Perform "18.1.8 Removing the Indicator, Receiver & Human Sensor Control Board to below side".
- 6 Perform "18.1.9 Removing the Indicator, Receiver & Human Sensor Control Board from unit".
- 7 Perform "18.1.10 Removing the Electronic Controller Box and Bracket".
- 8 Perform "18.1.11 Removing the nanoe Controller Box".
- 9 Perform "18.1.12 Removing the Drive Motor of the Vertical and Horizontal Direction Louver (Left side)".
- 10 Perform "18.1.13 Removing the Front Grille bracket (Frame - Air Filter)".
- 11 Perform "18.1.14 Removing the Drive Motor of the Vertical and Horizontal Direction Louver (Right side)".
- 12 Disconnect the drain hose and pull the blowout / discharge grille to remove it.

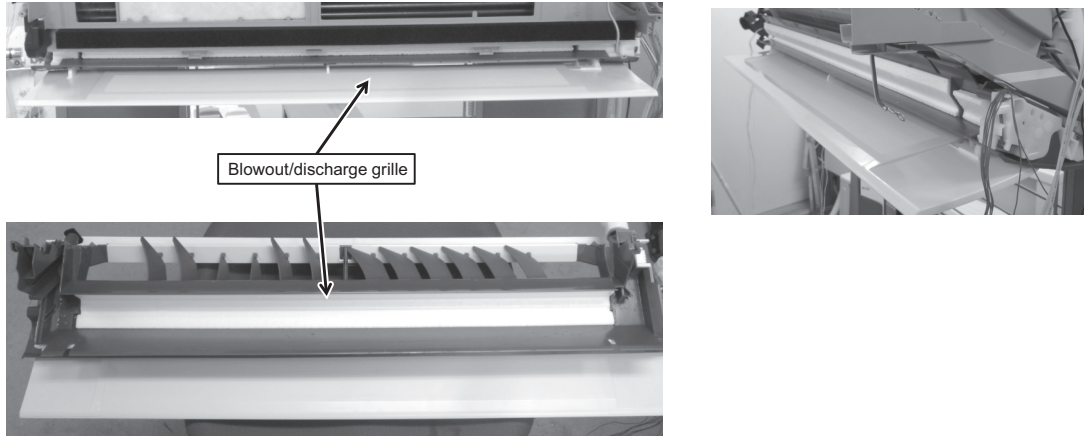

18.1.16 Removing the Indoor Motor and Cross Flow Fan

- 1 Perform "18.1.1 Removing the Front Panel".
- 2 Perform "18.1.2 Removing the Air Filters".
- 3 Perform "18.1.3 Removing the Front Grille (Right) and Front Grille (Left)".
- 4 Perform "18.1.4 Removing the Control Board (Electronic Controller)".
- 5 Perform "18.1.8 Removing the Indicator, Receiver & Human Sensor Control Board to below side".
- 6 Perform "18.1.9 Removing the Indicator, Receiver & Human Sensor Control Board from unit".
- 7 Perform "18.1.10 Removing the Electronic Controller Box and Bracket".
- 8 Perform "18.1.11 Removing the nanoe Controller Box".
- 9 Perform "18.1.12 Removing the Drive Motor of the Vertical and Horizontal Direction Louver (Left side)".
- 10 Perform "18.1.13 Removing the Front Grille bracket (Frame - Air Filter)".
- 11 Perform "18.1.14 Removing the Drive Motor of the Vertical and Horizontal Direction Louver (Right side)".
- 12 Perform "18.1.15 Removing the Discharge Grille".
- 13 Remove the screws (2 pieces) on the left side of the heat exchanger.

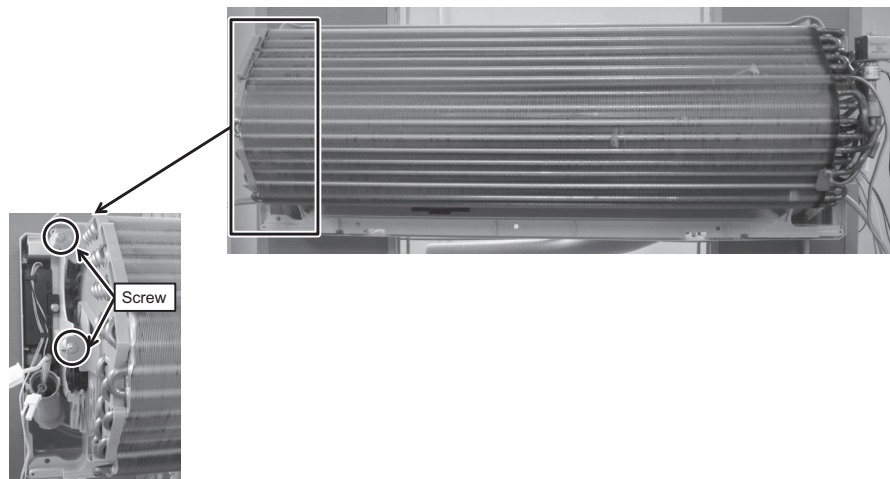

14 Loosen the fixing screw (1 screw) which fixes the cross flow fan to the indoor motor.

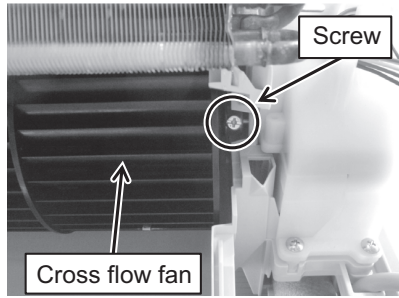

15 Pull out the cross flow fan while lifting up the left side of the heat exchanger.

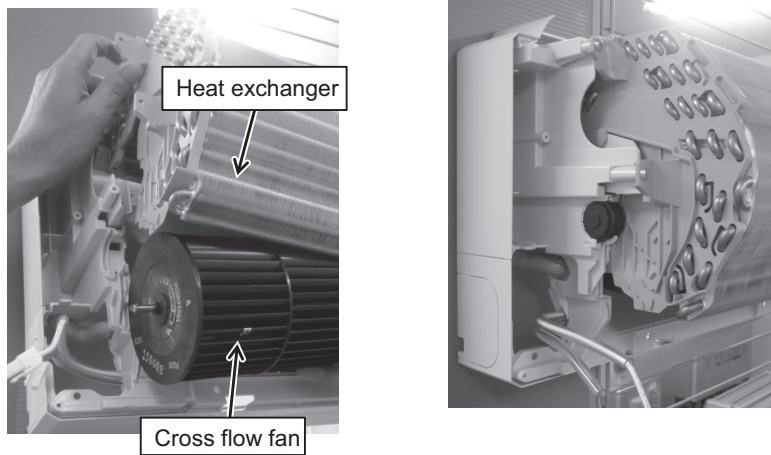

16 Remove the screw (3 pieces) of the motor cover and pull out the motor together with the cover to the right side to remove it.

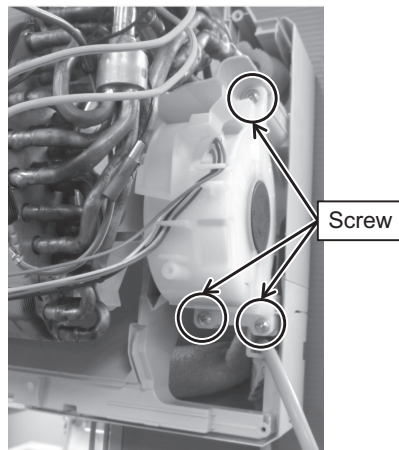

18.2 Vertical Airflow Direction Louver

*Please replace the vertical airflow direction louver (for the upper side) in accordance with the following steps.

18.2.1 Steps to remove the vertical airflow direction louver (for the upper side)

1. Check that the product is plugged in.
2. Hold down the Eco Navi button on the remote control for 5 seconds and wait until the **vertical airflow direction louver** opens and stops automatically.
Unplug after it stops.
※ **Please operate with the power unplugged from this point.**
3. Take off the **vertical airflow direction louver (for the upper side)**
 - ① Pinch the tab of the fixed lock on the right side.
 - ② Slide it to the left side and remove the right vane axis from the right stepping motor axis.
 - ③ Slowly take down the right side of the **vertical airflow direction louver (for the upper side)** to the point where it does not contact the corner of the front grill. Slide the **vertical airflow direction louver (for the upper side)** to the right side and then remove it from the main unit central axis and the left stepping motor axis.

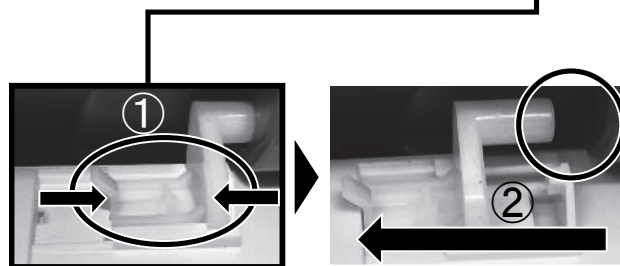
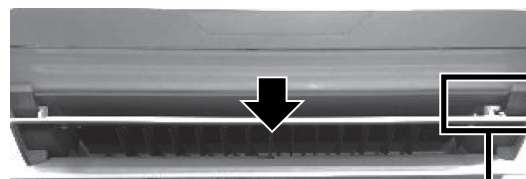

※ Pinch the tab and slide it to the left to remove.

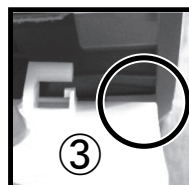
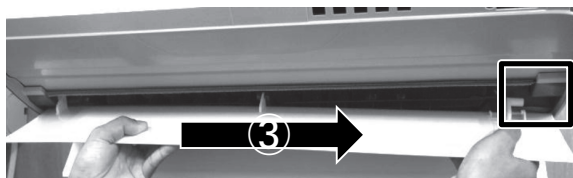

※ Take it down to the position where the right side of the vertical airflow direction louver (for the upper side) does not contact the corner of the front grill.

※ Slide it to the right to remove.



【Removal completed】

18.2.2 Steps to install the vertical airflow direction louver (for the upper side)

1. First, align the tip of the main unit central axis to the hole of the vane central fixed part.

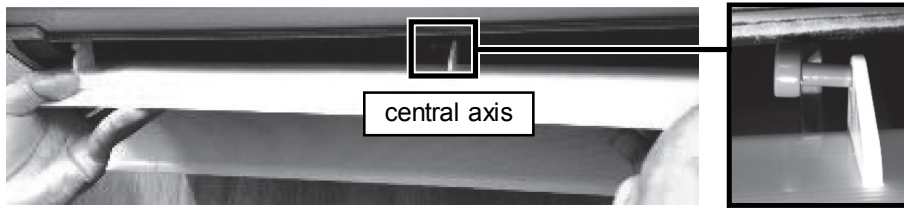

2. Slide the vane left axis to the left while aligning it with the left axis of the stepping motor and then insert the main unit central axis and vane left axis simultaneously.

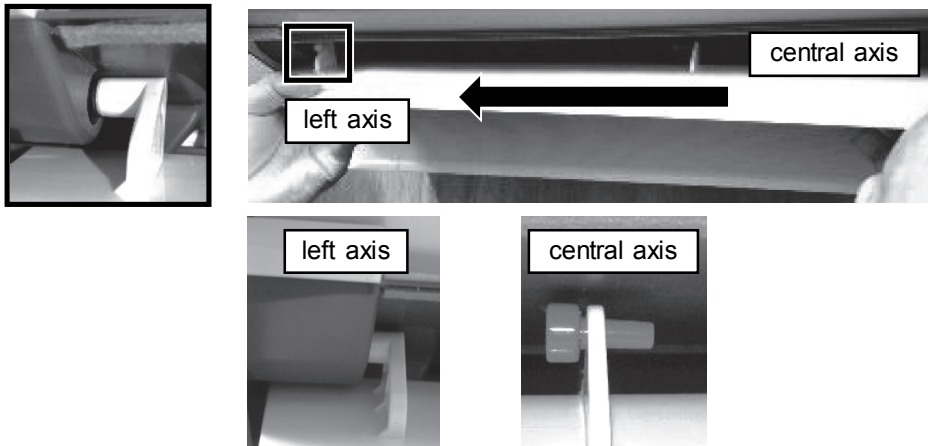

※ **Make sure that the vane right axis and main unit central axis are inserted.**

3. Insert the vane right axis in such a way as to slide it to the right while aligning it with the right axis of the stepping motor.

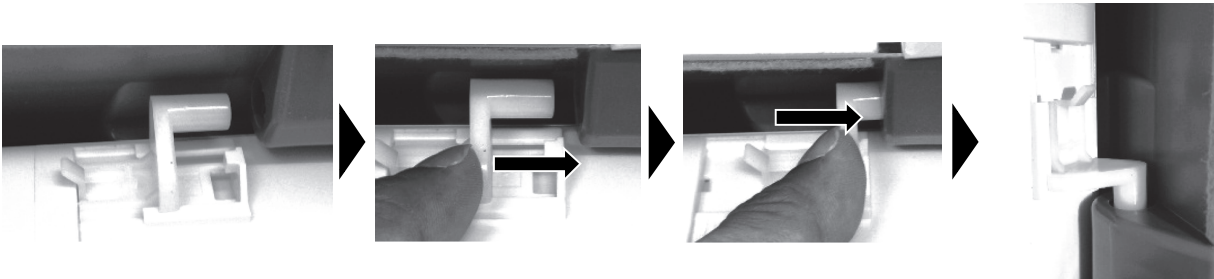

【Completion of Installation】

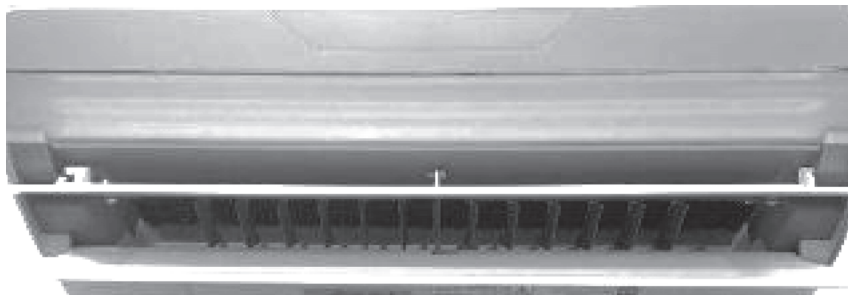

※ **When the replacement is finished, please plug in the power plug and check if it works fine.** Run the product and make sure that there are no abnormalities in the behaviors and sounds from the **vertical airflow direction louver (for the upper side)**.

18.2.3 Steps to remove the vertical airflow direction louver (for the lower side)

1. Check that the product is plugged in.
2. Hold down the Eco Navi button on the remote control for 5 seconds and wait until the **vertical airflow direction louver** opens and stops automatically.
Unplug after it stops.
※ **Please operate with the power unplugged from this point.**
3. Take off the **vertical airflow direction louver (for the lower side)**
 - ① Pinch the tab of the fixed lock on the right side.
 - ② Slide it to the left side and remove the right vane axis from the right stepping motor axis.
 - ③ Slowly take down the right side of the **vertical airflow direction louver (for the lower side)** to the point where it does not contact the corner of the front grill. Slide the **vertical airflow direction louver (for the lower side)** to the right side and then remove it from the main unit central axis and the left stepping motor axis.

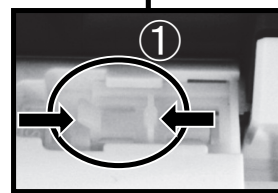
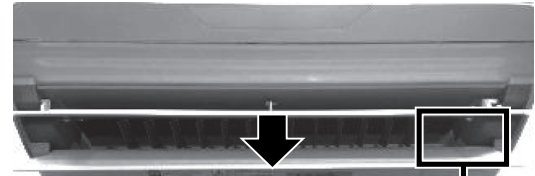

※ Pinch the tab and slide it to the left to remove.

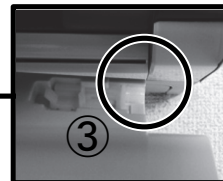
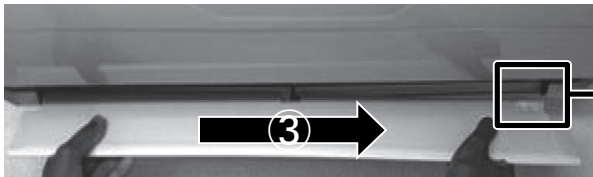

※ Take it down to the position where the right side of the vertical airflow direction louver (for the lower side) does not contact the corner of the front grill.

※ Slide it to the right to remove.



【Removal completed】

18.2.4 Steps to install the vertical airflow direction louver (for the lower side)

1. First, align the tip of the main unit central axis to the hole of the vane central fixed part.

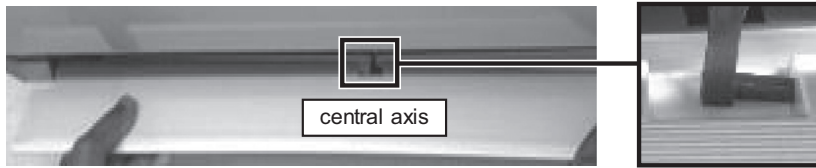

2. Slide the vane left axis to the left while aligning it with the left axis of the stepping motor and then insert the main unit central axis and vane left axis simultaneously.

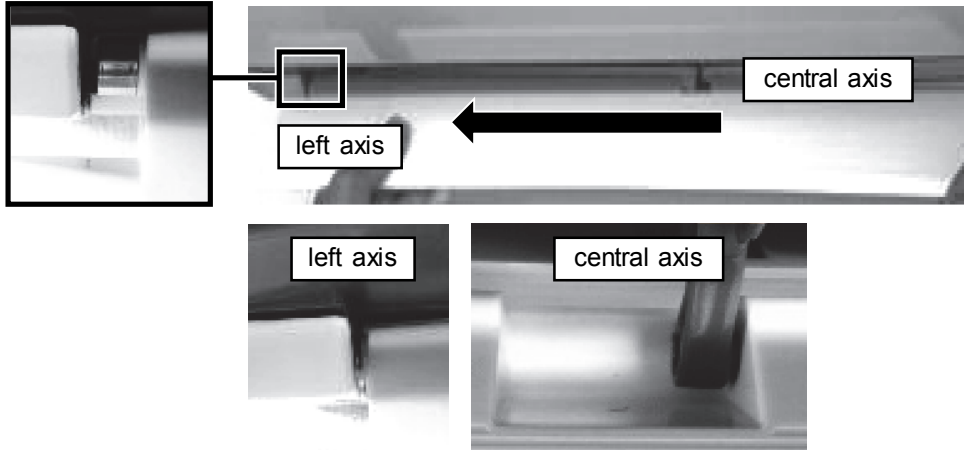

※ **Make sure that the vane right axis and main unit central axis are inserted.**

3. Insert the vane right axis in such a way as to slide it to the right while aligning it with the right axis of the stepping motor.

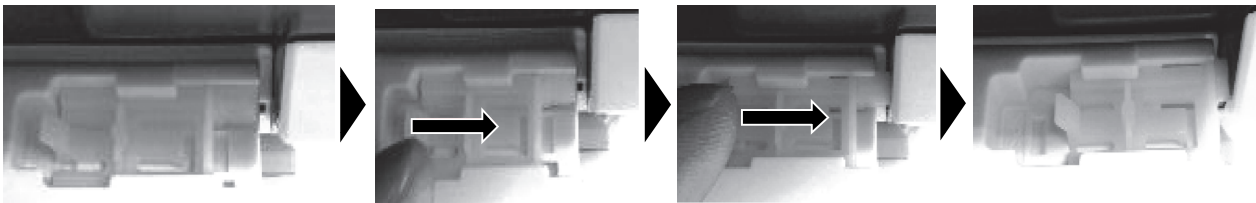

【Completion of Installation】

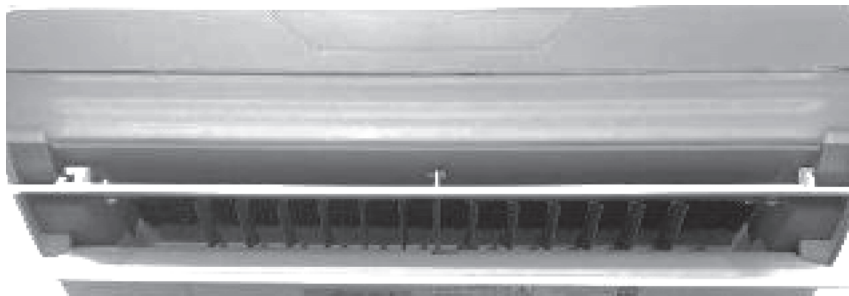

※ **When the replacement is finished, please plug in the power plug and check if it works fine.** Run the product and make sure that there are no abnormalities in the behaviors and sounds from the **vertical airflow direction louver (for the lower side)**.

18.3 Points of Disassembly (Outdoor Unit)



CAUTION: HIGH VOLTAGE

The electrical components of the outdoor unit are under high voltage by the operation of the booster capacitor. Fully discharge the capacitor before commencing a repair work. Failure to observe this warning could result in electric shock.

18.3.1 Removing the Outer Top Panel and Outer Front Panel

- 1 Remove the screws of the outer top panel.
 - Remove 2 screws on the right, 2 screws on the left and 1 screw on the front side, all from the front view. Then, remove the outer top panel.

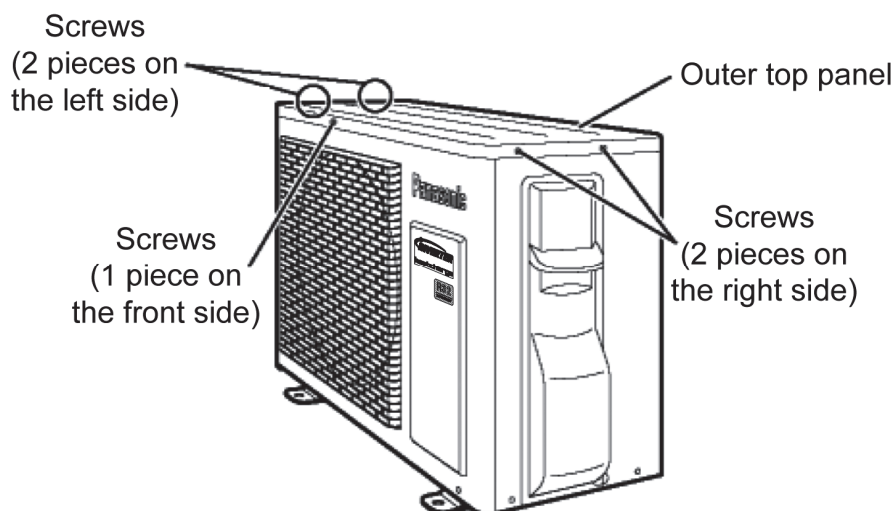

- 2 Remove the screws of the outer front panel.
 - Remove 2 screws on top, 3 screws at the bottom and 1 screw on the right side, all from the front view.

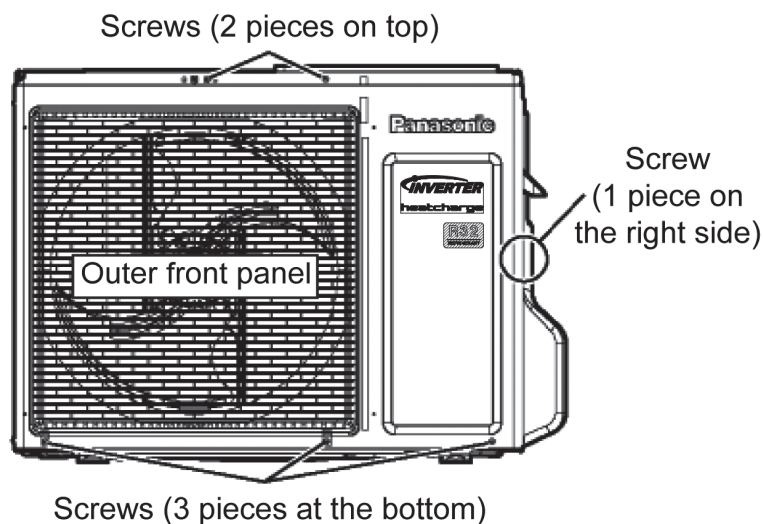

- 3 Disengage the tabs on the outer front panel (3 locations on the left side and 1 location on the right side). Remove the outer front panel while pulling it slightly up.

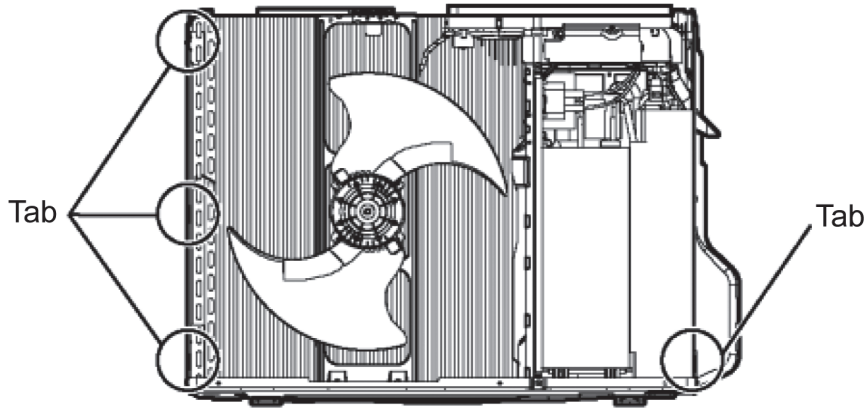

18.3.2 Removing the Electrical Component Covers (2 & 3-way valve Cover and Terminal Plate Cover)

- 1 Remove the screw (1 piece) of the electrical component cover (2 & 3-way valve cover). Slide the electrical component cover (2 & 3-way valve cover) downward to remove it.

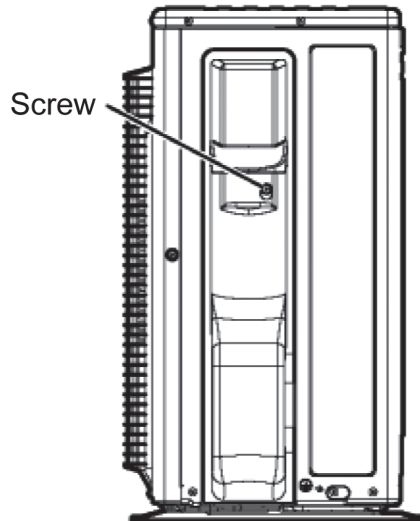

- 2 Remove the screws (2 pieces) and disengage the tabs (2 locations) of the electrical component cover (terminal plate cover). Then, remove the electrical component cover (terminal plate cover).

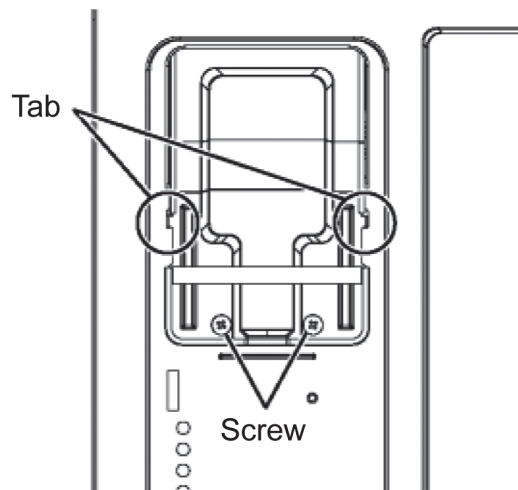

18.3.3 Removing the Power-Supply Box

- 1 Perform "17.2.1 Removing the Outer Top Panel and Outer Front Panel".
- 2 Perform "17.2.2 Removing the Electrical Component Covers (2 & 3-way valve Cover and Terminal Plate Cover)".
- 3 Disengage 4 tabs of the electrical component cover (the top cover of the control board) (2 locations each on the right and left sides). Remove the electrical component cover (the top cover of the control board).

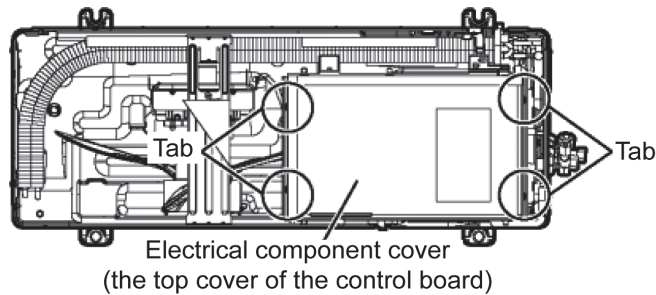

- 4 Remove the fixing screw (1 piece) of the power-supply box and the fixing screw (1 piece) of the power supply box cover.

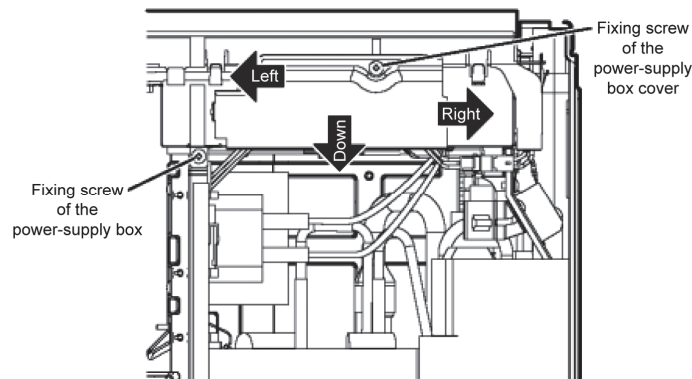

- 5 Disconnect the connectors and terminals.

■ Wiring from down side

- Lead wires of the compressor (red, blue and yellow).....Disconnect the connector at the compressor terminal.
- CN-HOT (white).....Electromagnetic coil (4-way valve). Wire color: blue, red and black.
- 2 wires of the reactor connecting terminal. Wire color: gray and white.
- CN-TANK (white).....Compressor temperature sensor.
- CN-TH2 (red).....Aluminium electric heater tank temperature sensor.
- CN-TH4 (white).....Aluminium electric heater 3-way valve temperature sensor.
- Lead wires of the aluminium electric heater.....Connector for the thermal fuse & aluminium electric heater tank. Connector color: red.

■ Wiring from left side

- CN-MTR1 (red).....Outdoor fan motor.
- CN-MTR2 (white).....Outdoor fan motor.
- Lead wires of the base pan heater.....Connector color: white.

■ Wiring from right side

- CN-STM1 (white).....Electromagnetic coil (expansion valve).
- CN-STM2 (white).....Electromagnetic coil (3-way valve).
- CN-TH1 (white).....Outside air temperature and pipe temperature 1.
- CN-TH3 (blue).....Outside pipe temperature sensor 2.

- 6 Disconnect the connector of the indoor/outdoor connection wires (Brown, Blue and Black) and remove the fixing screw of the earth wire (green).
- 7 Remove the screw (2 piece) which fixes the power-supply box to the outer side panel (right).

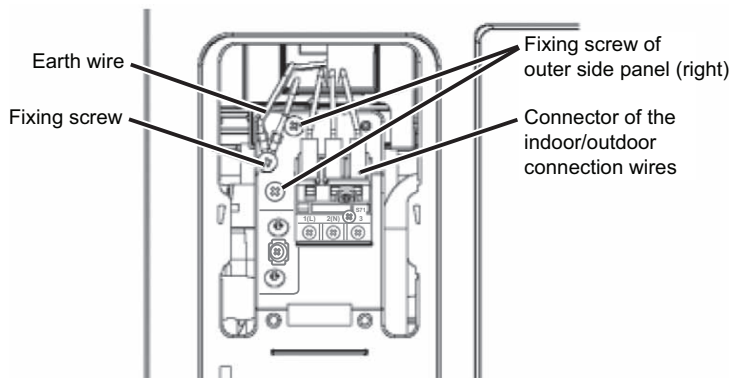

- 8 Pull the outer side panel (right) towards you while pulling up the fixing tab (1 location) of the powersupply box to disengage the tab.

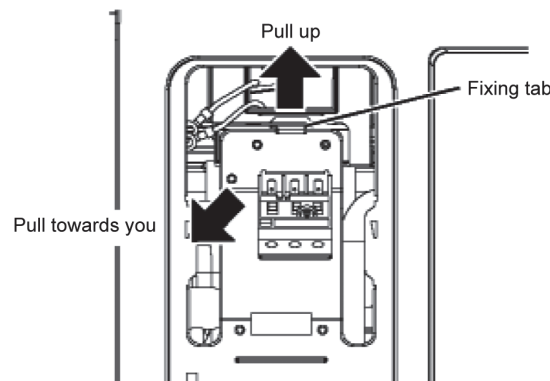

- 9 Lift up the power-supply box to remove it.

18.3.4 Removing the Control Board

- 1 Perform "17.2.1 Removing the Outer Top Panel and Outer Front Panel".
- 2 Perform "17.2.2 Removing the Electrical Component Covers (2 & 3-way valve Cover and Terminal Plate Cover)".
- 3 Perform "17.2.3 Removing the Power-Supply Box".
- 4 Disengage the tabs (6 locations) and remove the metal cover.

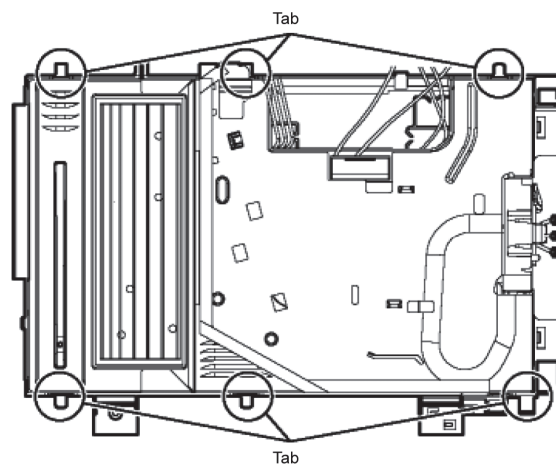

※ Notes on disassembly: During the replacement of outdoor control board, the control board and plastic power-supply box are separated by removing the screws (2 pieces) on the soldered surface. These two parts can be replaced as an integrated piece by applying silicon to them.

18.3.5 Removing the Propeller Fan and Outdoor Motor

- 1 Perform "17.2.1 Removing the Outer Top Panel and Outer Front Panel".
- 2 Disengage 4 tabs of the electrical component cover (the top cover of the control board) (2 locations each on the right and left sides). Remove the electrical component cover (the top cover of the control board).

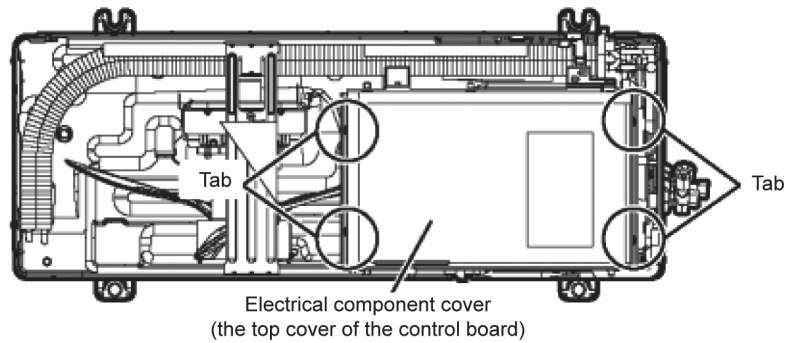

- 3 Remove the fixing screw (1 piece) of the power-supply box.

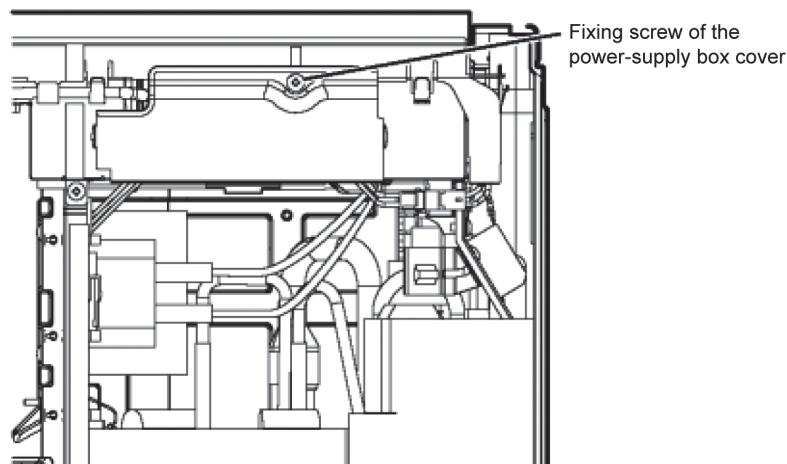

- 4 Disconnect the connectors of CN-MTR1 (red) and CN-MTR2 (white) only.
※ Notes on assembly: When performing the wiring after the replacement of the outdoor motor, close the top cover of the control board before connecting the connectors of CN-MTR1 & 2 for wiring. If the wiring is performed without closing the top cover of the control board, the wire may get pinched while closing the cover.
- 5 Rotate the nut located in the center of the propeller fan clockwise. Then, remove the propeller fan.

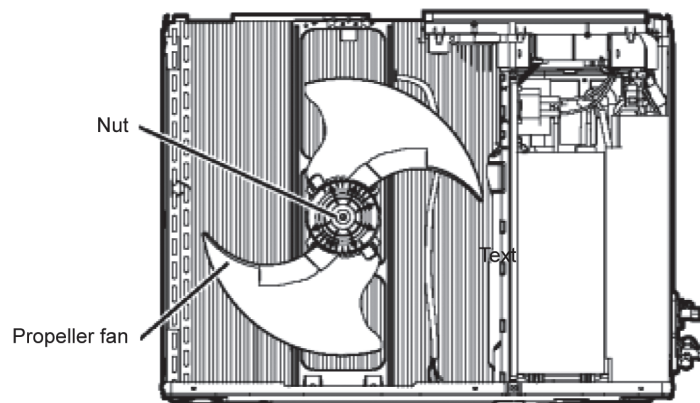

- Loosen the fixing screws (4 pieces) of the outdoor motor and remove the outdoor motor.

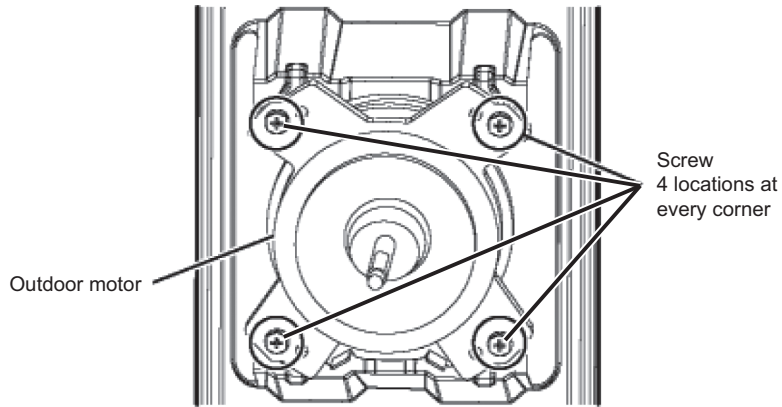

※ Notes on assembly: When assembling the propeller fan and outdoor motor, the alignment mark located in the center part of the propeller fan should be aligned with the slit in the shaft of the outdoor motor.

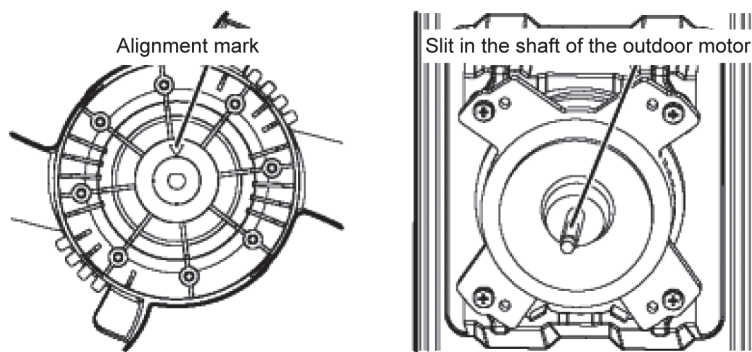

18.3.6 Removing the Outer Side Panel (Right)

- Perform "17.2.1 Removing the Outer Top Panel and Outer Front Panel".
- Perform "17.2.2 Removing the Electrical Component Covers (2 & 3-way valve Cover and Terminal Plate Cover)".
- Disconnect the connector of the indoor/outdoor connection wires (red, white and black) and remove the fixing screw of the earth wire (green).
- Remove the screw (2 piece) which fixes the power-supply box to the outer side panel (right).

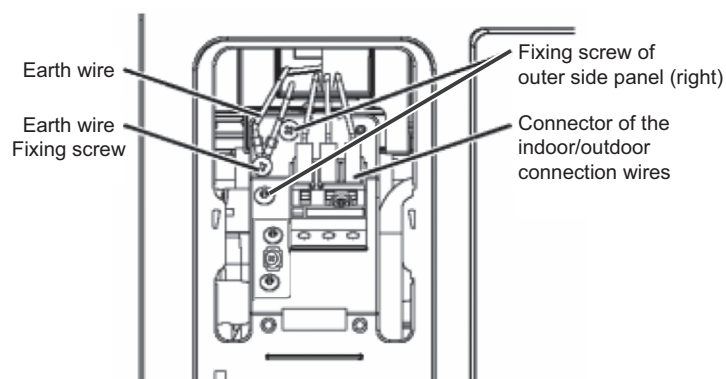

- 5 Pull the outer side panel (right) towards you while pulling up the fixing tab (1 location) of the power-supply box to disengage the tab.

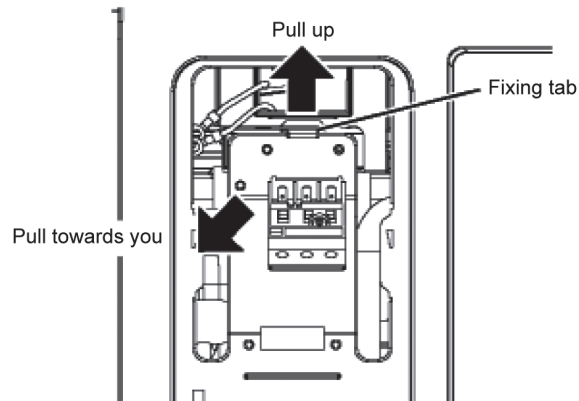

- 6 Remove the fixing screws (5 pieces) of the outer side panel (right) and remove the outer side panel (right).
※ Note on disassembly: When removing the outer side panel (right) by pulling it upward, be careful not to allow the side of the outer side panel to come into contact with the pipe insulation material/tape to avoid damage and tear of these materials.

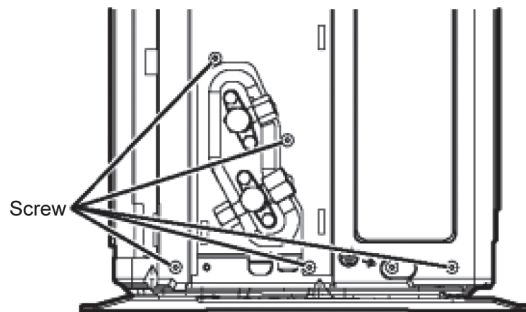

18.3.7 Removing the Compressor and Aluminium Electric Heater (Heatcharge)

- 1 Perform "17.2.1 Removing the Outer Top Panel and Outer Front Panel".
- 2 Perform "17.2.2 Removing the Electrical Component Covers (2 & 3-way valve Cover and Terminal Plate Cover)".
- 3 Perform "17.2.3 Removing the Power Supply Box".
- 4 Perform "17.2.6 Removing the Outer Side Panel (Right)".
- 5 Remove the 4-way valve coil, expansion valve coil, 3-way valve coil (Aluminium Electric Heater).
- 6 Remove the fixing screw of the acoustic insulation board and holder plate for 3-way valve & expansion valve (2 pieces on the right side and 1 pieces at the front bottom). Then, disengage the tab on the acoustic insulation board (2 location on the holder plate 3-way valve & expansion valve and 1 location on the bottom side).
- 7 Remove the holder plate for 3-way valve & expansion valve from acoustic insulation board.
- 8 Remove the fixing screw of the earth wire (yellow/green) at the acoustic insulation board.

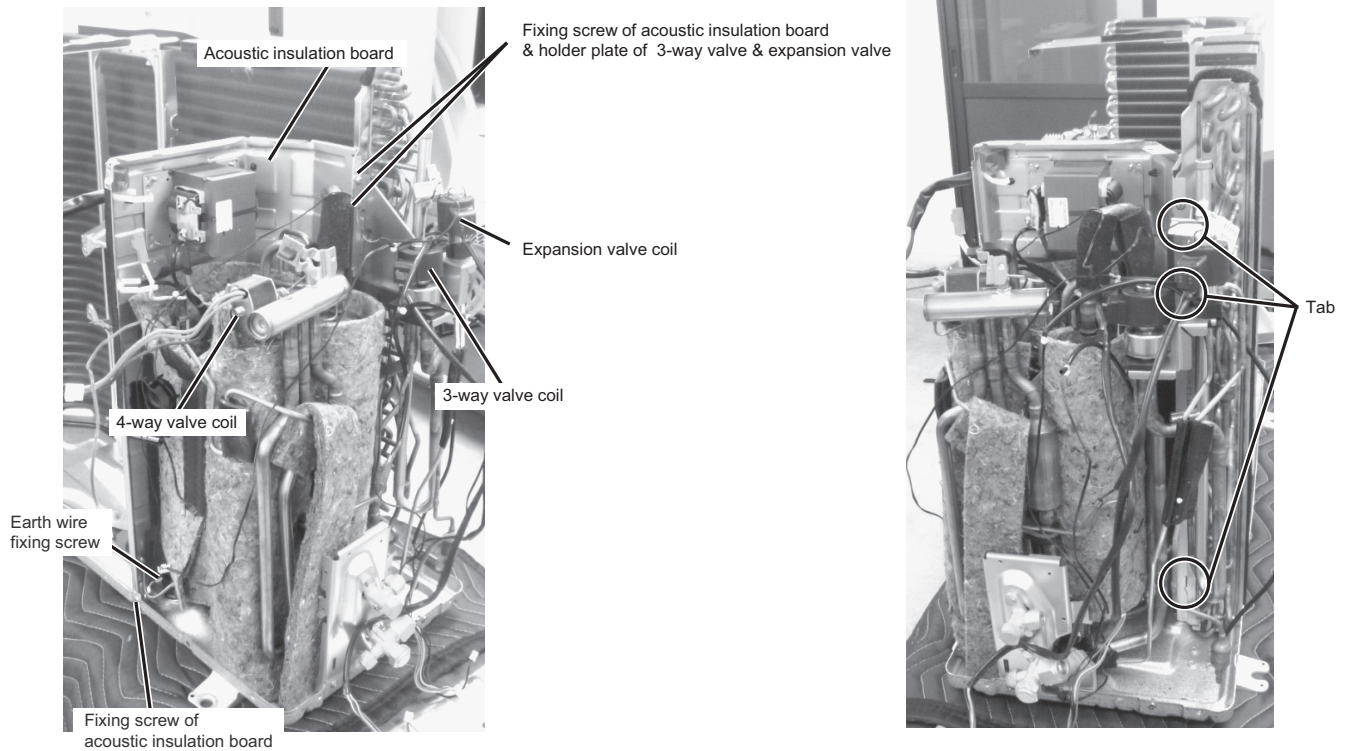

- 9 Remove the acoustic insulation board.

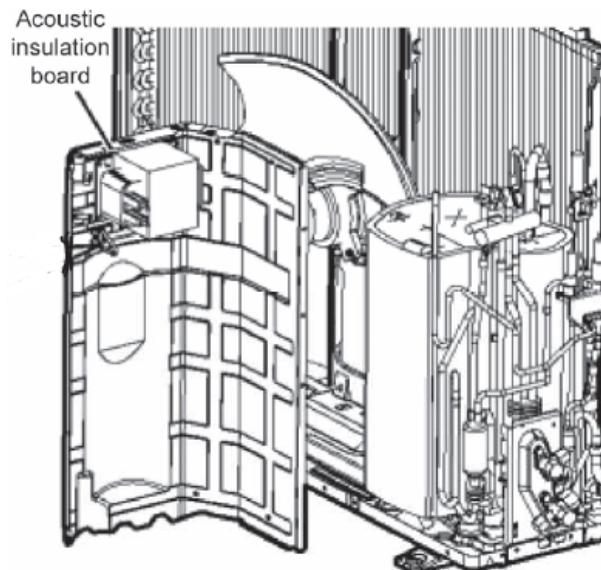

- 10 Remove the acoustic insulation material and then remove the nuts which fix the compressor (3 locations).
Note on disassembly: Use a box wrench to remove the compressor nut.

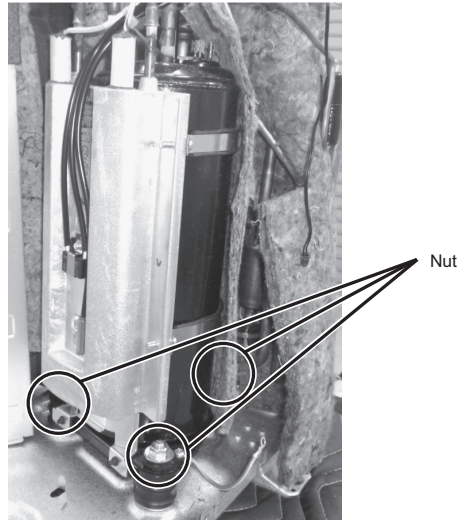

- 11 Remove the welded parts (4 locations).
- a. Aluminium electric heater inlet.
 - b. Aluminium electric heater outlet.
 - c. Compressor suction.
 - d. Compressor discharge.

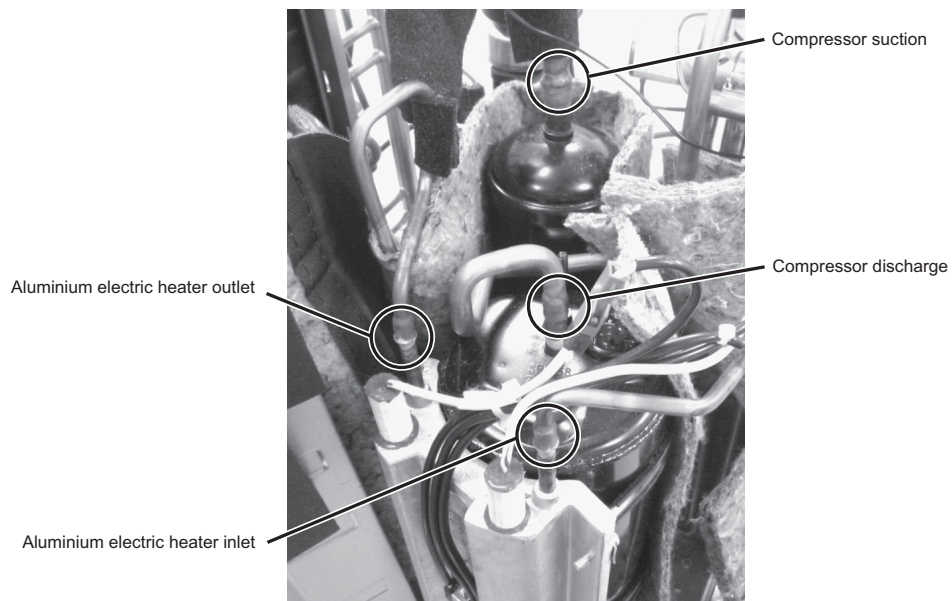

12 Remove the compressor and aluminium electric heater.

- Remove the fixing screw for clamping bracket of the aluminium electric heater (2 pieces). (The aluminium electric heater is attached to the compressor with clamp)
- Remove the clamping bracket and separate the compressor and aluminium electric heater.

Note on disassembly: Remove the aluminium electric heater sensor when replacing the aluminium electric heater.

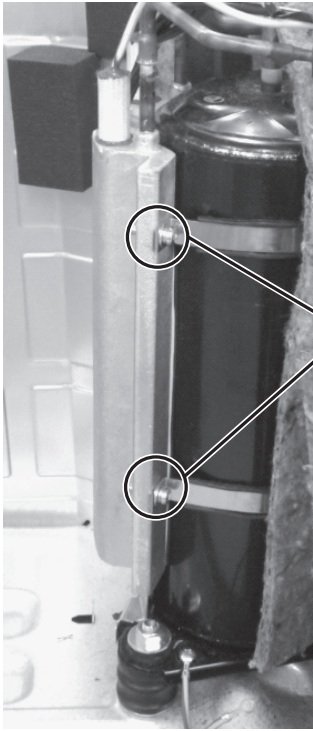

Fixing screw of clamping aluminium electric heater

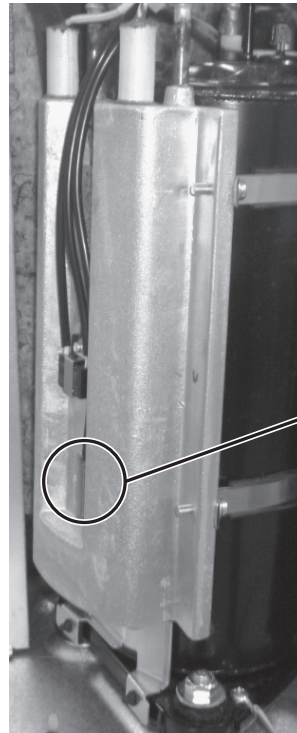

Aluminium electric heater sensor

18.3.8 Aluminium Electric Heater Replacement Procedure (Heatcharge)

18.3.8.1 Preparation

- 1 Power-off the unit (remove plug and/or etc.).
- 2 Collect all refrigerant into the cylinder by reclaiming machine.
- 3 As brazing work is involved, make sure the workshop and surrounding area is sufficient and safe.

18.3.8.2 Process 1 (Dismatling of the Parts)

- 1 Remove control-board cover, top plate and front panel, pull out connecting wire, then remove side panel (right).
- 2 Disconnect all connectors connected to control board.
- 3 Remove solenoid coils of 3-way valve, 4-way valve and expansion valve.
- 4 Remove sound proof material at upper compressor.
- 5 Remove terminal cover for the compressor.
- 6 Disconnect of 3 compressor lead wire (red, blue and yellow), and remove control board.

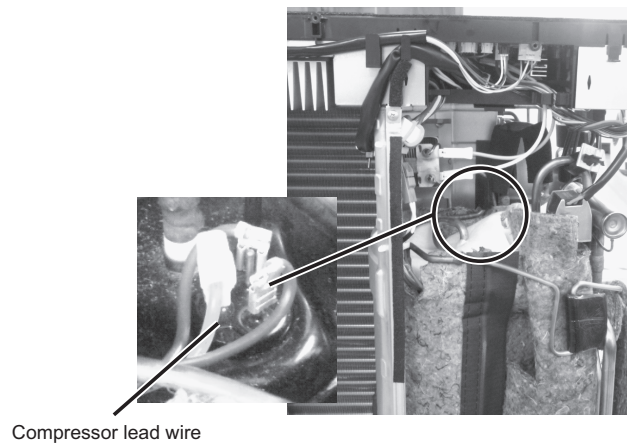

* Aluminum electric heater: part description is aluminum electric heater (Heatcharge)

- 7 Remove 4 screws (see figure), 1 fixing screw for earth wire, 2 fixing screws for holder plate of 3-way valve & expansion valve and 1 fixing screw for sound proof board. Slide soundproof board towards to propeller fan side to remove.

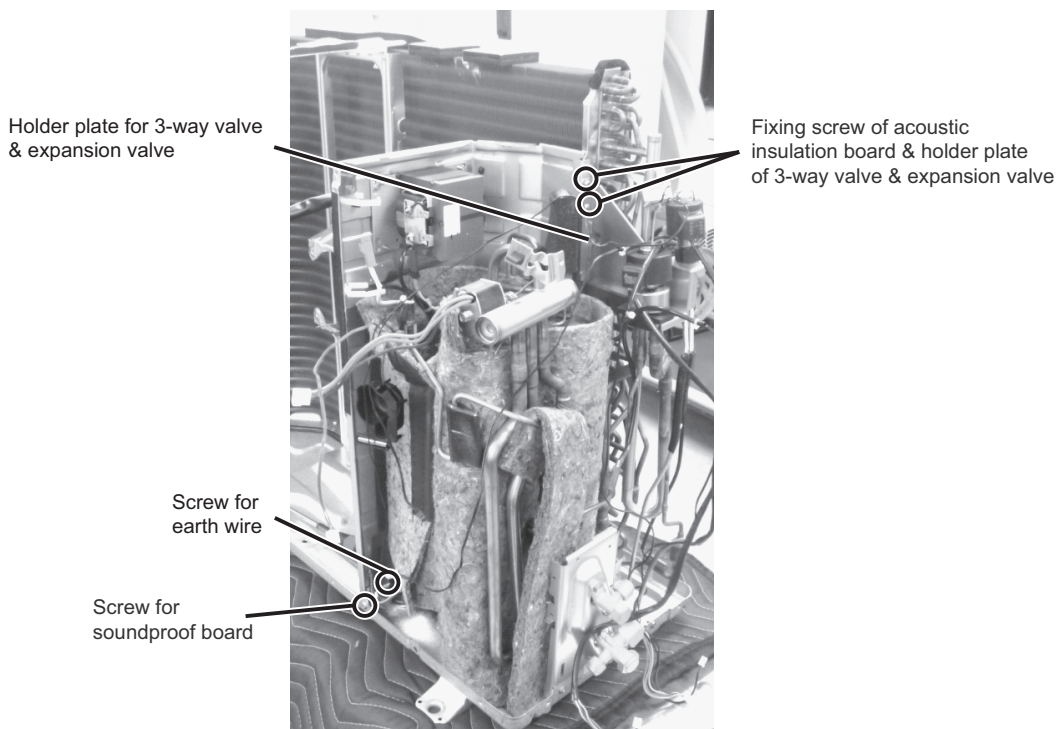

18.3.8.3 Process 2 (Removing brazing point)

- 1 Remove tape (poly-e foam) from piping prior to removing the brazing point.

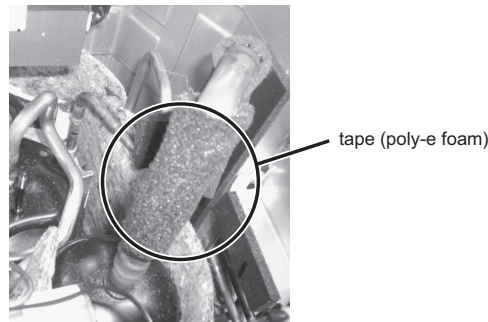

Caution

Protection from the brazing flame should be considered during replacing the parts. Firstly disconnect the which pipe entering to aluminium electric heater, compressor suction and the compressor discharge pipes.

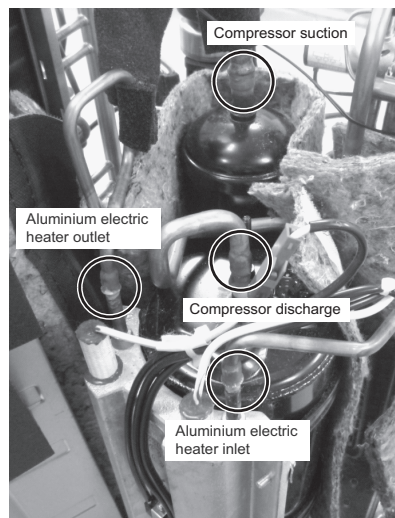

18.3.8.4 Separate Compressor from Aluminium Electric Heater

- 1 Take out blocks of compressor and aluminium electric heater from base pan.
- 2 Remove the fixing screw for clamping bracket of the aluminium electric heater (2 pieces) and lift the bracket to remove.
- 3 Separate the aluminium electric heater from compressor.

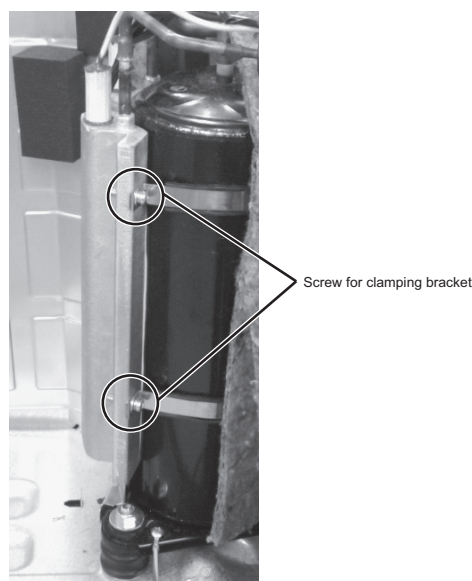

18.3.8.5 Replacement of Aluminium Electric Heater (Heatcharge)

Exchange with the new aluminium electric heater.

- 1 Install aluminium electric heater by fixing clamping bracket to the original position.
- 2 Fix back sensor for aluminium electric heater to the original location.

Caution

Carefully read the instructions before proceeding to the replacement of aluminium electric heater.

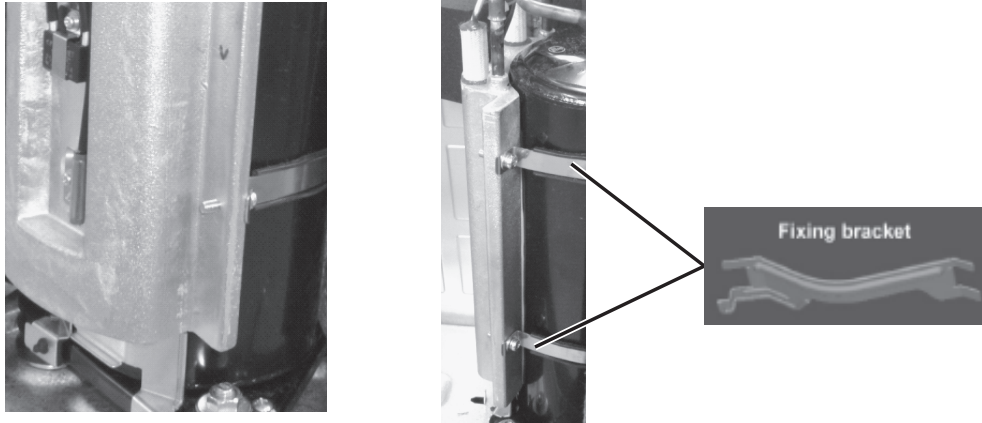

18.3.8.6 Fix-back compressor and Connect the Tubes

- 1 Set compressor and aluminium electric heater to the original position.
- 2 Tighten 3 mounting nuts of compressor by using wrench.
- 3 Braze-back the tubes you dismantled.

Caution

Protection from the brazing flame should be considered during brazing back the parts, too.

- 4 After brazing tubes, use cooling rag (wet towel) to cool it down and put the materials such as tape (Poly-e foam) and etc., as original conditions.

18.3.8.7 Assemble Electrical Parts

- 1 Put back electrical parts to their original position.
- 2 Install soundproof material around compressor and secure soundproof board.
- 3 Put back each sensor to their original position.

18.3.8.8 Setting Exterior Parts

- 1 Set and attach side panel (right) by using screws.
- 2 Set control board and insert each connector.

18.3.8.9 Vacuuming, Filling Refrigerant and Checking for Gas Leaks

- 1 Return outdoor equipment to where it was. Vacuum, fill coolant and check for gas leaks then test.

19. Technical Data

Technical data provided are based on the air conditioner running under free frequency.

19.1 Cool Mode Performance Data

Unit setting: Standard piping length, Hi Fan, Cool mode at 16°C

Voltage: 230V

19.1.1 CS-VZ9SKE CU-VZ9SKE

Indoor (°C)		Outdoor DB (°C)								
DB	WB	16			25			35		
		TC	SHC	IP	TC	SHC	IP	TC	SHC	IP
27	19.0	2.99	2.66	0.24	2.81	2.53	0.33	2.50	2.40	0.43
	22.0	3.40	2.07	0.23	3.16	1.96	0.32	2.78	1.81	0.43
23	15.7	2.70	2.57	0.24	2.63	2.47	0.32	2.35	2.30	0.43
	18.4	3.05	2.04	0.22	2.80	1.93	0.31	2.59	1.78	0.42
20	13.3	2.18	2.14	0.23	2.11	2.07	0.32	1.85	1.81	0.42
	15.8	2.40	1.73	0.20	2.30	1.68	0.29	2.09	1.61	0.40

19.1.2 CS-VZ12SKE CU-VZ12SKE

Indoor (°C)		Outdoor DB (°C)								
DB	WB	16			25			35		
		TC	SHC	IP	TC	SHC	IP	TC	SHC	IP
27	19.0	4.186	3.726	0.446	3.93	3.54	0.606	3.50	3.36	0.800
	22.0	4.76	2.904	0.422	4.43	2.75	0.595	3.89	2.53	0.792
23	15.7	3.784	3.594	0.442	3.68	3.46	0.600	3.29	3.22	0.792
	18.4	4.271	2.862	0.412	3.92	2.70	0.582	3.62	2.50	0.780
20	13.3	3.056	2.995	0.433	2.95	2.89	0.588	2.59	2.54	0.776
	15.8	3.357	2.417	0.372	3.23	2.35	0.536	2.92	2.25	0.745

TC - Total Cooling Capacity (kW)

SHC - Sensible Heat Capacity (kW)

IP - Input Power (kW)

19.2 Heat Mode Performance Data

Unit setting: Standard piping length, Hi Fan, Heat mode at 30°C

Voltage: 230V

19.2.1 CS-VZ9SKE CU-VZ9SKE

Indoor (°C)	Outdoor DB (°C)					
	-20		2		7	
DB	TC	IP	TC	IP	TC	IP
24	4.63	2.41	5.56	2.48	7.86	2.72
20	4.70	2.36	5.70	2.41	7.90	2.72
16	4.84	2.24	5.93	2.28	8.06	2.72

19.2.2 CS-VZ12SKE CU-VZ12SKE

Indoor (°C)	Outdoor DB (°C)					
	-20		2		7	
DB	TC	IP	TC	IP	TC	IP
24	4.93	2.69	6.53	2.88	9.15	3.16
20	5.00	2.63	6.70	2.80	9.20	3.16
16	5.15	2.49	6.97	2.65	9.38	3.16

TC - Total Capacity (kW)

IP - Input Power (kW)

20. Service Data

Service data provided are based on the air conditioner running under rated frequency during forced cooling / forced heating mode.

20.1 Cool Mode Outdoor Air Temperature Characteristic

Condition

- Room Temperature: 27/19°C, Cooling Characteristic
- Fan: High
- Piping Length: 5.0 m
- Freq: Rated Fc

20.1.1 CS-VZ9SKE CU-VZ9SKE

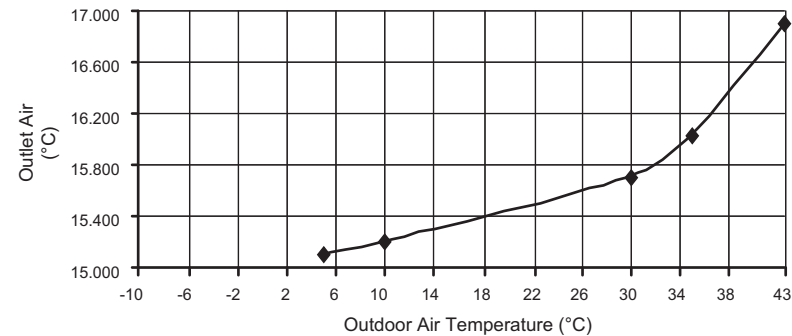
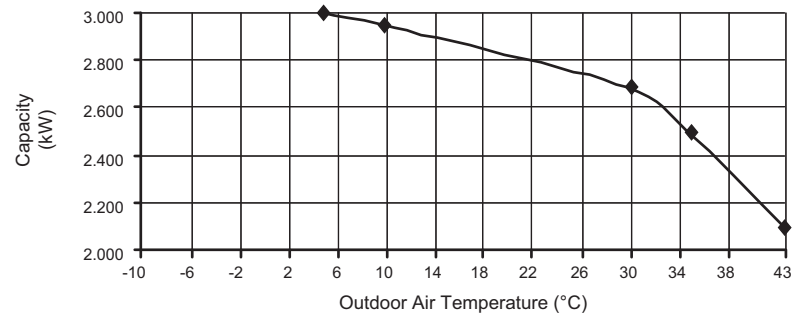
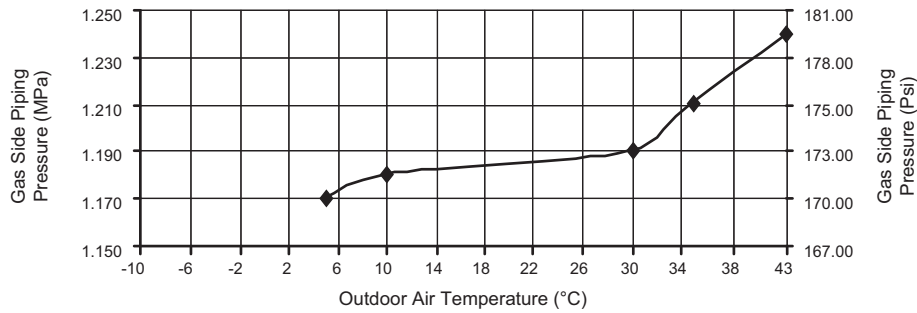
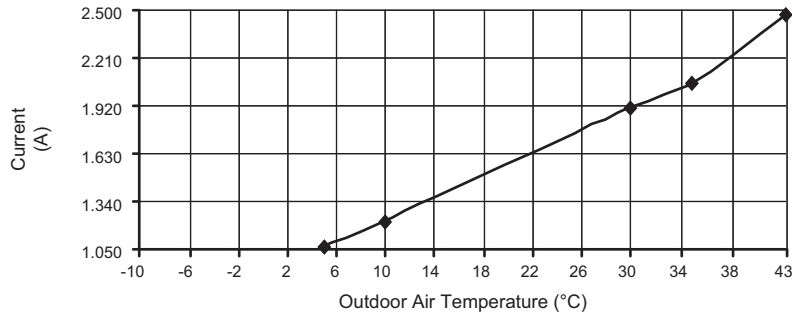

20.1.2 CS-VZ12SKE CU-VZ12SKE

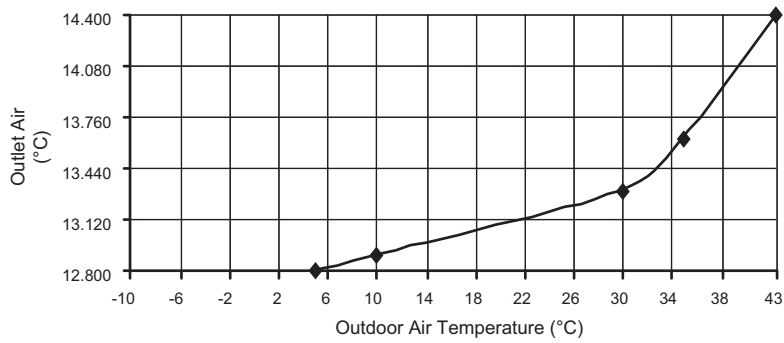
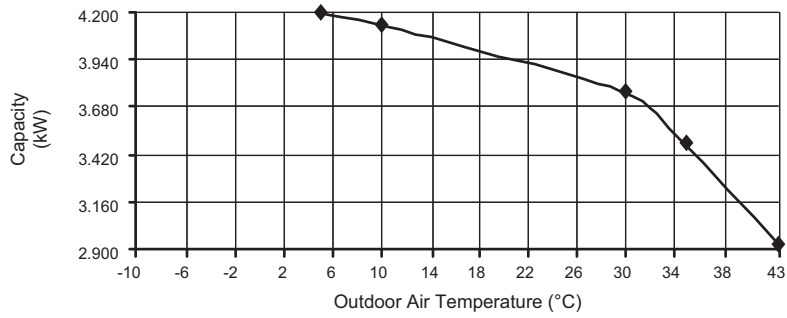
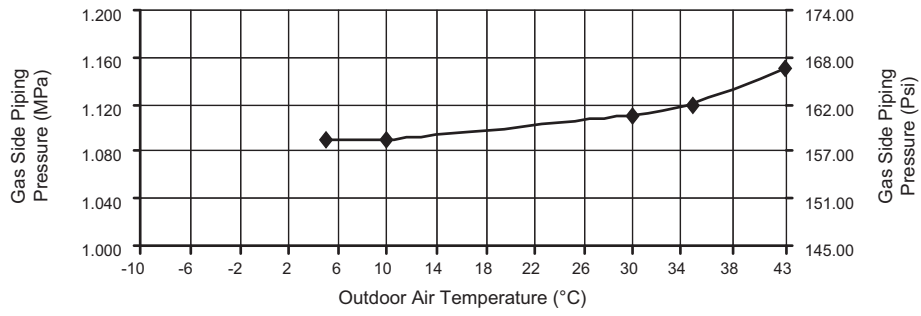
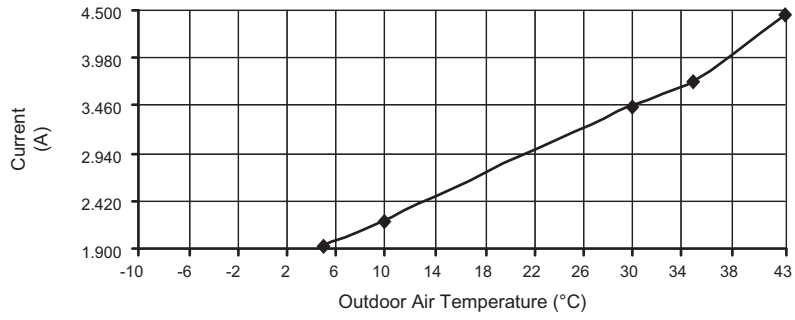

20.2 Heat Mode Outdoor Air Temperature Characteristic

Condition

- Room Temperature: 20°C, Heating Characteristic
- Fan: High
- Piping Length: 5.0 m
- Freq: Rated Fh

20.2.1 CS-VZ9SKE CU-VZ9SKE

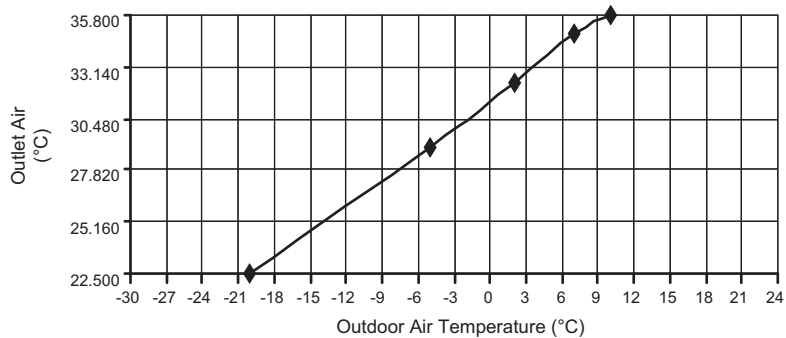
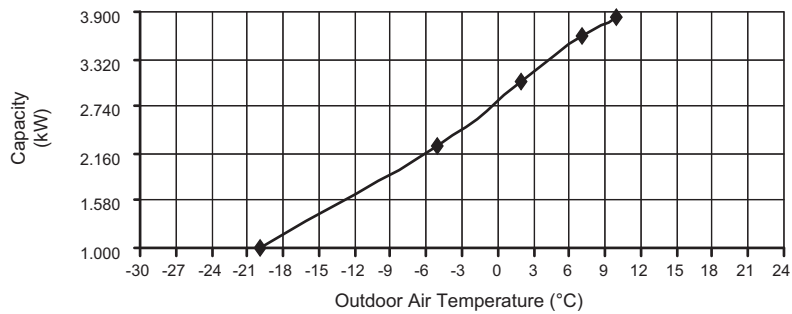
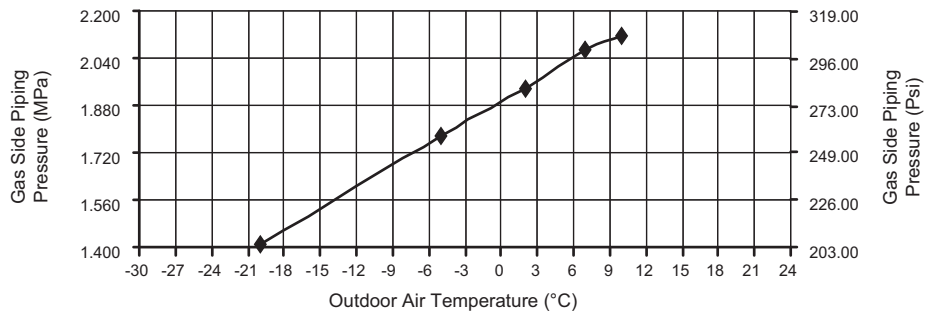
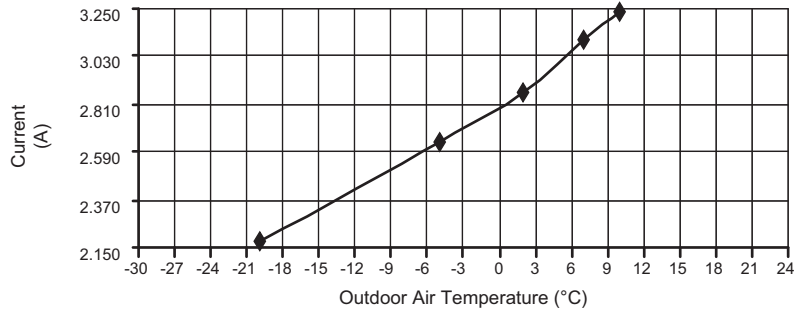

20.2.2 CS-VZ12SKE CU-VZ12SKE

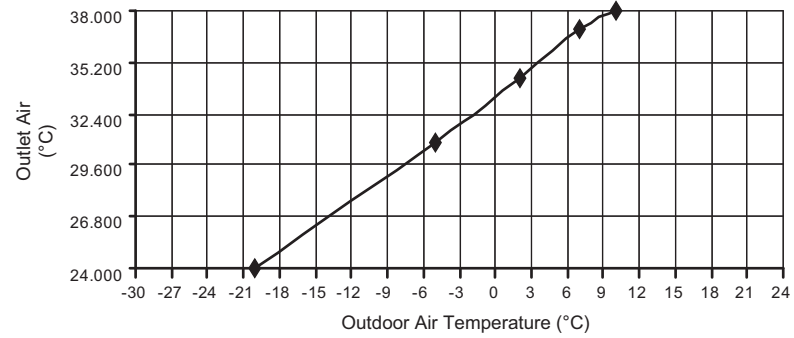
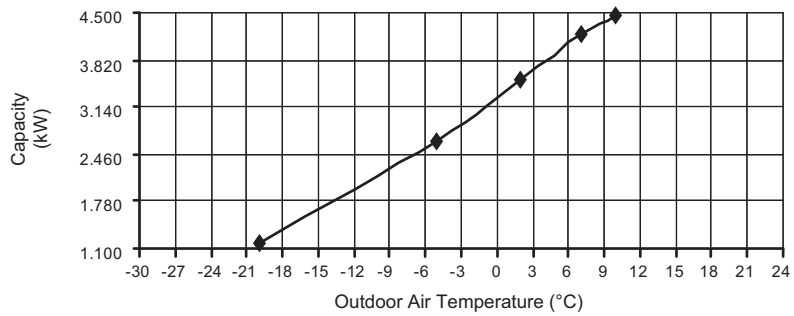
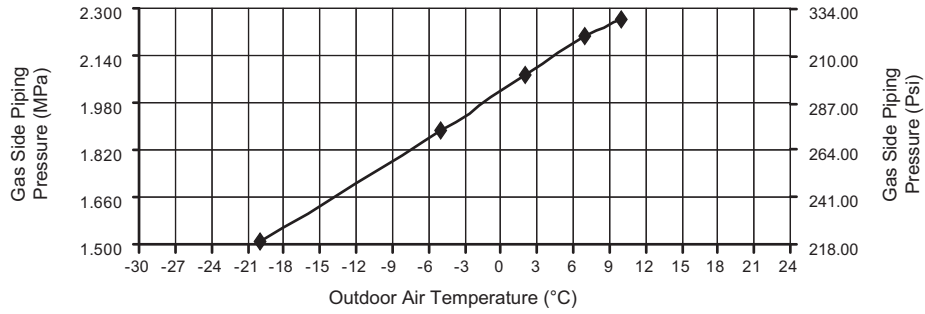
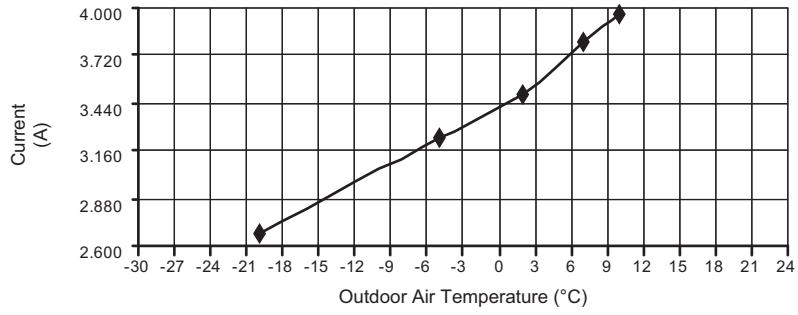

20.3 Piping Length Correction Factor

The characteristic of the unit has to be corrected in accordance with the piping length.

20.3.1 CS-VZ9SKE CU-VZ9SKE

20.3.1.1 Cooling Capacity

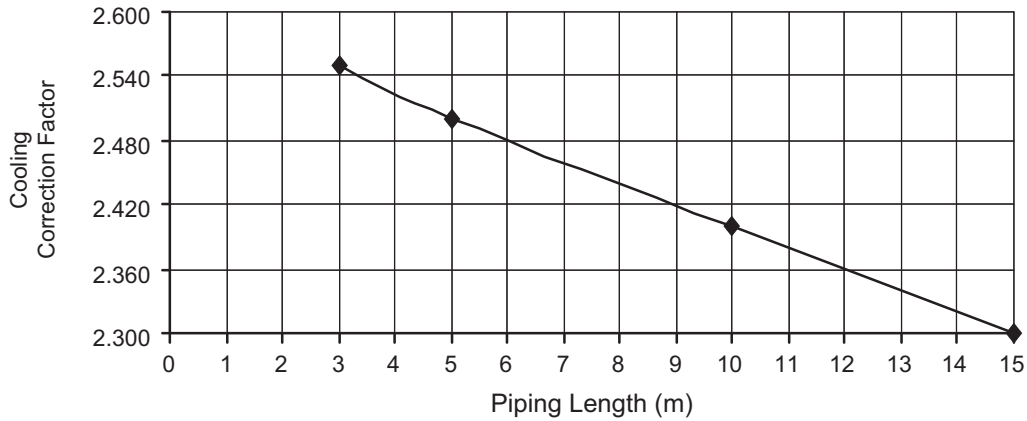

Piping length	Capacity (kW)
3	2.55
5	2.50
10	2.40
15	2.30

20.3.1.2 Heating Capacity

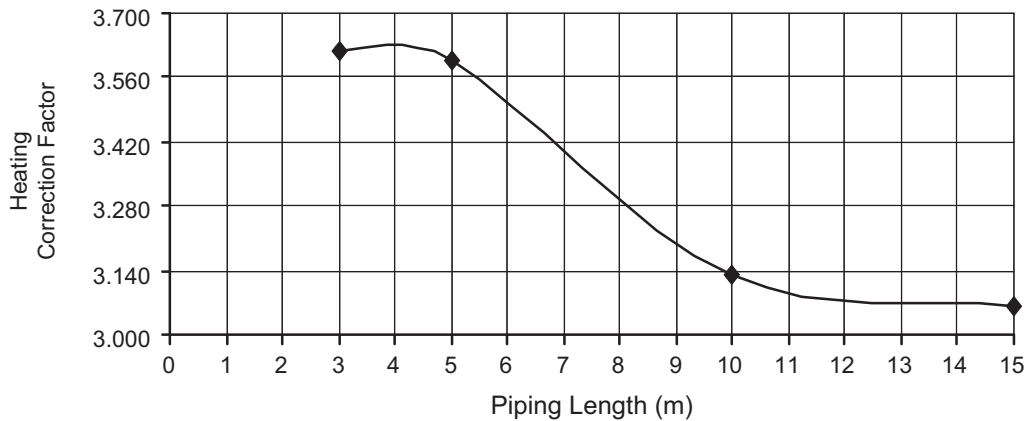

Piping length	Capacity (kW)
3	3.62
5	3.60
10	3.13
15	3.06

Note: The graphs show the factor after added right amount of additional refrigerant.

20.3.2 CS-VZ12SKE CU-VZ12SKE

20.3.2.1 Cooling Capacity

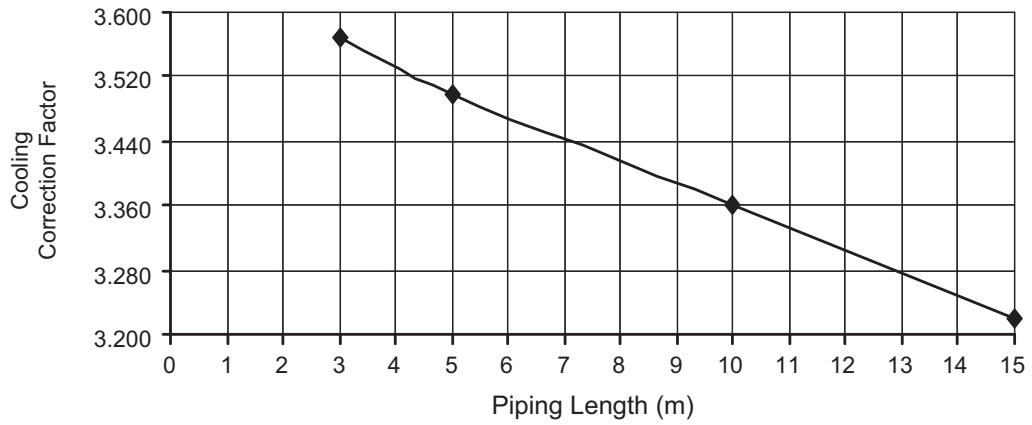

Piping length	Capacity (kW)
3	3.57
5	3.50
10	3.36
15	3.22

20.3.2.2 Heating Capacity

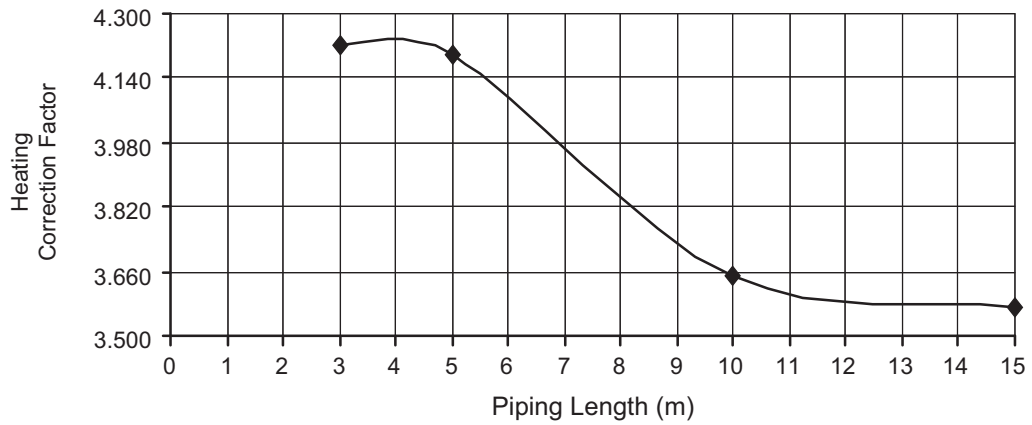

Piping length	Capacity (kW)
3	4.22
5	4.20
10	3.65
15	3.57

Note: The graphs show the factor after added right amount of additional refrigerant.

21. Exploded View and Replacement Parts List

21.1 Indoor Unit

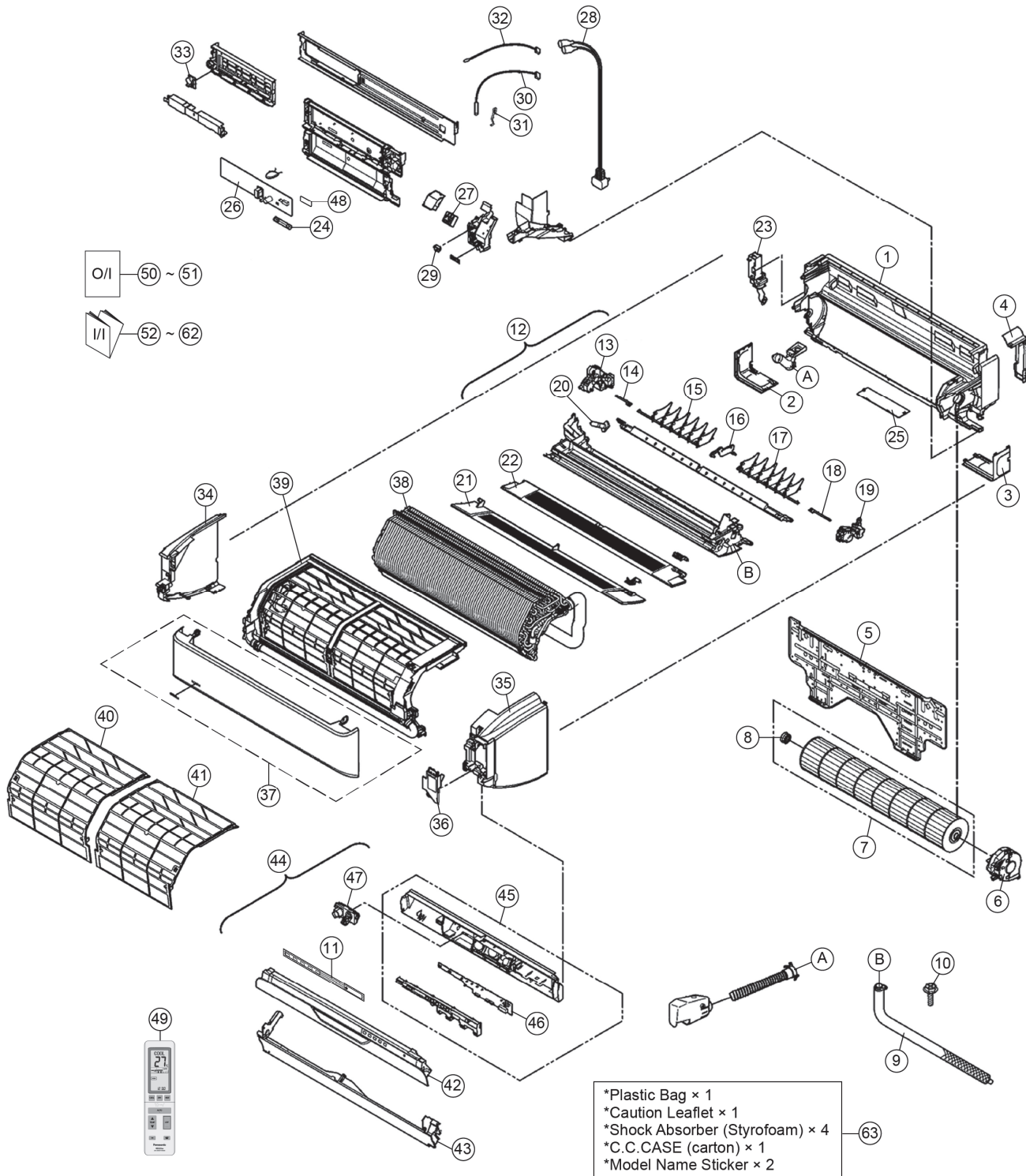

Note
 The above exploded view is for the purpose of parts disassembly and replacement.
 The non-numbered parts are not kept as standard service parts.

SAFETY	REF. NO.	PART NAME & DESCRIPTION	QTY.	CS-VZ9SKE	CS-VZ12SKE	REMARK
	1	CHASSIS COMPLETE	1	ACRD50C00170	←	
	2	L SHAPE PLATE (LEFT)	1	CWD601291	←	
	3	L SHAPE PLATE (RIGHT)	1	CWD601292	←	
	4	PIPE HOLDER (PLASTIC)	1	CWD912541	←	
	5	INSTALLING HOLDER	1	CWH361160	←	
⚠	6	FAN MOTOR W/BRACKET	1	ACRD54C00040	←	O
	7	CROSS FLOW FAN	1	ACRH02C00100	←	
	8	BEARING ASSY	1	CWH64K1011	←	
	9	DRAIN HOSE	1	CWH851219	←	
	10	SCREW - DRAIN HOSE	1	CWH551401	←	
	11	CONTROL PANEL	1	CWE312938	←	
	12	DISCHARGE GRILLE COMPLETE	1	ACRE20C00230	←	
⚠	13	GEAR COMPLETE (LEFT)	1	CWH68C1098	←	O
	14	LEVER ARM (LEFT)	1	CWH651106	←	
	15	VERTICAL VANE (LEFT)	1	ACRE24C00260	←	
	16	FULCRUM	1	CWH621165	←	
	17	VERTICAL VANE (RIGHT)	1	ACRE24C00270	←	
	18	LEVER ARM (RIGHT)	1	CWH651107	←	
⚠	19	GEAR COMPLETE (RIGHT)	1	CWH68C1099	←	O
	20	CAP	1	CWH521096	←	
	21	HORIZONTAL VANE (UPPER)	1	CWE24C1524XE	←	
	22	HORIZONTAL VANE (LOWER)	1	CWE24C1523XE	←	
⚠	23	GENERATOR COMPLETE (nanoe)	1	CWH94C0062	←	O
⚠	24	FUSE (3.1A)	1	K5D312YYA054	←	O
	25	PARTICULAR PLATE (BOTTOM - CHASSIS)	1	ACRD90-00520	←	
⚠	26	ELECTRONIC CONTROLLER - MAIN	1	ACRA73C02920	ACRA73C02930	O
⚠	27	TERMINAL BOARD COMPLETE	1	CWA28C2570	←	O
⚠	28	POWER SUPPLY CORD	1	ACRA20C00100	←	
	29	SWITCH (AUTO)	1	K0KABE000007	←	O
	30	THERMISTOR (INDOOR H. EXCHANGER)	1	CWA50C2811	←	O
	31	HOLDER PIPE - THERMISTOR	1	CWH711019	←	
	32	THERMISTOR (INDOOR AIR - TEMP)	1	CWA50C3020	←	O
⚠	33	ELECTRONIC CONTROLLER (AUTO)	1	CWA746568	←	O
	34	FRONT GRILLE FRAME (LEFT)	1	CWE12C1095	←	
	35	FRONT GRILLE FRAME (RIGHT)	1	CWE12C1096XE	←	
	36	GRILLE DOOR COMPLETE	1	CWE14C1140	←	
	37	INTAKE GRILLE ASS'Y	1	ACRE22K00080X	←	
	38	HEAT EXCHANGER (INDOOR)	1	ACRB30C00880	←	
	39	FRAME - AIR FILTER	1	ACRD01C00120	←	
	40	AIR FILTER (LEFT)	1	ACRD00-00130	←	O
	41	AIR FILTER (RIGHT)	1	ACRD00-00140	←	O
	42	PARTICULAR PLATE (UPPER)	1	CWD91C0266	←	
	43	PARTICULAR PLATE (LOWER)	1	CWD912552	←	
	44	SENSOR CASE COMPLETE	1	CWE18C1121	←	
	45	BOX SHAPED PLATE - COMPLETE	1	CWD66C1043	←	
⚠	46	ELECTRONIC CONTROLLER - INDICATOR	1	CWA745768	←	O
	47	SENSOR CASE COMPLETE	1	CWE18C1094	←	
⚠	48	ZNR (VARISTOR)	1	ERZVEAV621	←	

SAFETY	REF. NO.	PART NAME & DESCRIPTION	QTY.	CS-VZ9SKE	CS-VZ12SKE	REMARK
	49	REMOTE CONTROL COMPLETE	1	ACRA75C00100X	←	O
	50	USER MANUAL (eng, fre, spa, deu, ita, dut)	1	ACRF55-00860	←	
	51	USER MANUAL (swe, nor, fin, dan, bul)	1	ACRF55-00870	←	
	52	INSTALLATION INSTRUCTION (nor)	1	ACRF60-01380	←	
	53	INSTALLATION INSTRUCTION (swe)	1	ACRF60-01390	←	
	54	INSTALLATION INSTRUCTION (fin)	1	ACRF60-01400	←	
	55	INSTALLATION INSTRUCTION (dan)	1	ACRF60-01410	←	
	56	INSTALLATION INSTRUCTION (eng)	1	ACRF60-01420	←	
	57	INSTALLATION INSTRUCTION (spa)	1	ACRF60-01430	←	
	58	INSTALLATION INSTRUCTION (ita)	1	ACRF60-01440	←	
	59	INSTALLATION INSTRUCTION (dut)	1	ACRF60-01450	←	
	60	INSTALLATION INSTRUCTION (bul)	1	ACRF60-01460	←	
	61	INSTALLATION INSTRUCTION (fre)	1	ACRF60-01470	←	
	62	INSTALLATION INSTRUCTION (deu)	1	ACRF60-01480	←	
	63	PACKING MATERIAL SET	1	ACR1VZ9SKE	ACR1VZ12SKE	

(Note)

- All parts are supplied from ACBD, Japan (Vendor Code: 00025800).
- "O" marked parts are recommended to be kept in stock.

21.2 Outdoor Unit

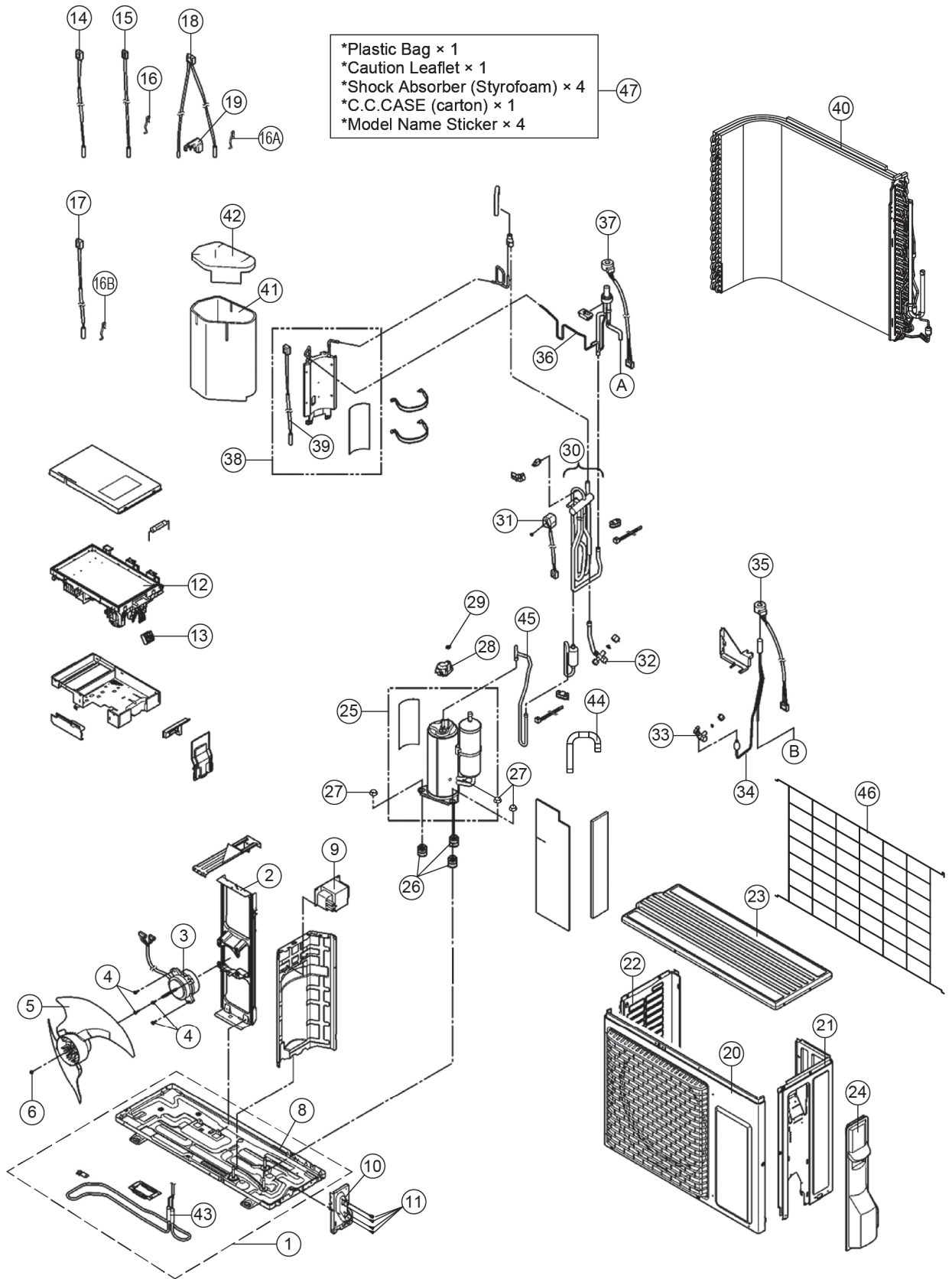

Note

The above exploded view is for the purpose of parts disassembly and replacement.
The non-numbered parts are not kept as standard service parts.

SAFETY	REF. NO.	PART NAME & DESCRIPTION	QTY.	CU-VZ9SKE	CU-VZ12SKE	REMARK
	1	CHASSIS COMPLETE (W/HEATER)	1	CWD50C1906	←	
	2	FAN MOTOR BRACKET	1	CWD541230	←	
⚠	3	FAN MOTOR (OUTDOOR)	1	L6CAYYYL0040	←	O
	4	SCREW - FAN MOTOR MOUNTING	4	CWH55252J	←	
	5	PROPELLER FAN ASS'Y	1	CWH03K1060	←	
	6	NUT - PROPELLER FAN	1	CWH56053J	←	
	7	SOUND PROOF BOARD COMPLETE	1	ACRH15C00020	←	
	8	CHASSIS	1	CWD50K2268	←	
⚠	9	REACTOR	1	G0C392J00018	←	O
	10	HOLDER - COUPLING	1	CWH351302	←	
	11	SCREW BOLT - COUPLING MOUNTING	4	XVG6B14VW/00	←	
⚠	12	ELECTRONIC CONTROLLER - MAIN	1	ACRA73C02980R	ACRA73C02990R	O
⚠	13	TERMINAL BOARD ASS'Y	1	CWA28K1121	←	O
	14	THERMISTOR - COMPRESSOR TEMP.	1	CWA50C3261	←	O
	15	THERMISTOR - HEAT CHARGE	1	CWA50C3012	←	O
	16	HOLDER THERMISTOR	1	CWH32138	←	
	16A	HOLDER THERMISTOR	1	CWH32138	←	
	16B	HOLDER THERMISTOR (HEAT EXCHANGER)	1	CWH32138	←	
	17	THERMISTOR - H.EXCHANGER (OUTDOOR)	1	CWA50C3263	←	O
	18	THERMISTOR - OUTDOOR AIR TEMP.	1	CWA50C3394	←	O
	19	HOLDER - OUTDOOR THERMISTOR	1	CWH321118	←	
	20	CABINET FRONT PLATE	1	ACRE06C00070	←	
	21	CABINET SIDE PLATE (RIGHT)	1	ACRE04C00260	←	
	22	CABINET SIDE PLATE (LEFT)	1	CWE041673	←	
	23	CABINET TOP PLATE	1	CWE031130	←	
	24	CONTROL BOARD COVER	1	CWH13C1330	←	
⚠	25	COMPRESSOR	1	ACRB09-00310	←	O
	26	ANTI VIBRATION BUSHING	3	CWH50154	←	
	27	NUT - COMPRESSOR MOUNTING	3	CWH56000J	←	
	28	TERMINAL COVER - COMPRESSOR	1	CWH171058	←	
	29	NUT - TERMINAL COVER	1	CWH7080300J	←	
	30	TUBE ASS'Y - 4 WAY VALVE	1	ACRT00-00930	←	
⚠	31	V.COIL - 4 WAY VALVE	1	CWA43C2606	←	O
	32	3 WAY VALVE (COUPLING)	1	ACRB01-00020	←	O
	33	2 WAY VALVE (COUPLING)	1	CWB021602	←	O
	34	TUBE ASS'Y - EXPANSION VALVE	1	ACRT00-03980	←	
⚠	35	V.COIL - EXPANSION VALVE	1	CWA43C2603	←	O
	36	TUBE ASS'Y HEAT CHARGE	1	ACRT00-00940	←	
⚠	37	V COIL - 3 WAY VALVE (HEAT CHARGE)	1	CWA43C2622	←	O
⚠	38	ALUMINIUM ELECTRIC HEATER (HEAT CHARGE)	1	ACRH90C00070	←	
	39	THERMISTOR - HEAT CHARGE	1	CWA50C3334	←	O
	40	HEAT EXCHANGER (OUTDOOR)	1	CWB32C3872	←	
	41	SOUND PROOF MATERIAL (COMPRESSOR)	1	CWG302972	←	
	42	SOUND PROOF MATERIAL (COMPRESSOR)	1	CWG302973	←	
	43	HEATER	1	CWA341107	←	
	44	SUCTION TUBE - COMPRESSOR	1	CWT338549	←	

SAFETY	REF. NO.	PART NAME & DESCRIPTION	QTY.	CU-VZ9SKE	CU-VZ12SKE	REMARK
	45	DISCHARGE TUBE - COMPRESSOR	1	CWT340893	←	
	46	WIRE NET (OUTDOOR)	1	CWD041205	←	
	47	PACKING MATERIAL SET	1	ACR2VZ9SKE	ACR2VZ12SKE	

(Note)

- All parts are supplied from ACBD, Japan (Vendor Code: 00025800).
- “O” marked parts are recommended to be kept in stock.