

Service Manual

Air Conditioner

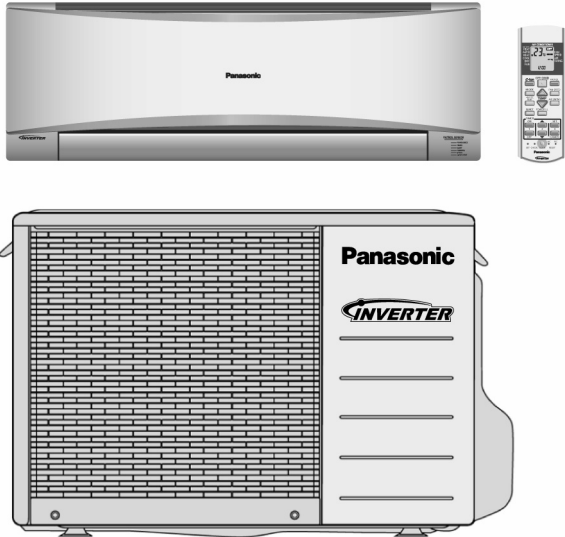

Indoor Unit
CS-QE9MKE
CS-QE12MKE
CS-WE9MKE
CS-WE12MKE

Outdoor Unit
CU-QE9MKE
CU-QE12MKE
CU-QE9MKE
CU-QE12MKE

WARNING

This service information is designed for experienced repair technicians only and is not designed for use by the general public. It does not contain warnings or cautions to advise non-technical individuals of potential dangers in attempting to service a product. Products powered by electricity should be serviced or repaired only by experienced professional technicians. Any attempt to service or repair the products dealt with in this service information by anyone else could result in serious injury or death.

PRECAUTION OF LOW TEMPERATURE

In order to avoid frostbite, be assured of no refrigerant leakage during the installation or repairing of refrigerant circuit.



TABLE OF CONTENTS

1. Safety Precautions	3	9. Electronic Circuit Diagram	19
2. Specification	5	9.1 Indoor Unit.....	19
3. Features	11	9.2 Outdoor Unit	20
4. Location of Controls and Components	12	10. Printed Circuit Board	21
4.1 Indoor Unit.....	12	10.1 Indoor Unit.....	21
4.2 Outdoor Unit.....	12	10.2 Outdoor Unit	24
4.3 Remote Control	12	11. Installation Instruction	25
5. Dimensions	13	11.1 Select the Best Location	25
5.1 Indoor Unit.....	13	11.2 Indoor Unit.....	26
5.2 Outdoor Unit.....	14	11.3 Outdoor Unit	30
6. Refrigeration Cycle Diagram	15	12. Operation Control	32
7. Block Diagram	16	12.1 Basic Function.....	32
8. Wiring Connection Diagram	17	12.2 Indoor Fan Motor Operation.....	33
8.1 Indoor Unit.....	17	12.3 Outdoor Fan Motor Operation	34
8.2 Outdoor Unit.....	18	12.4 Airflow Direction	34
		12.5 Quiet operation (Cooling Mode/Cooling area of Dry Mode).....	35

12.6	Quiet operation (Heating)	35
12.7	Powerful Mode Operation.....	36
12.8	Timer Control.....	36
12.9	Auto Restart Control.....	36
12.10	Indication Panel.....	37
12.11	Patrol Operation	37
12.12	e-ion Operation.....	40
12.13	+8/10°C Operation.....	42
13.	Protection Control.....	43
13.1	Protection Control For All Operations.....	43
13.2	Protection Control For Cooling & Soft Dry Operation.....	45
13.3	Protection Control For Heating Operation.....	46
14.	Servicing Mode.....	47
14.1	Auto OFF/ON Button	47
14.2	Remote Control Button.....	48
15.	Troubleshooting Guide.....	49
15.1	Refrigeration cycle system	49
15.2	Breakdown Self Diagnosis Function.....	51
15.3	Error Code Table.....	52
15.4	Self-diagnosis Method.....	54
16.	Disassembly and Assembly Instructions	79
16.1	Indoor Electronic Controllers, Cross Flow Fan and Indoor Fan Motor Removal Procedures	79
16.2	Outdoor Electronic Controller Removal Procedure	83
17.	Technical Data	84
17.1	Operation Characteristics.....	84
18.	Exploded View and Replacement Parts List	93
18.1	Indoor Unit.....	93
18.2	Outdoor Unit	96

1. Safety Precautions







- Read the following “SAFETY PRECAUTIONS” carefully before perform any servicing.
- Electrical work must be installed or serviced by a licensed electrician. Be sure to use the correct rating of the power plug and main circuit for the model installed.
- The caution items stated here must be followed because these important contents are related to safety. The meaning of each indication used is as below. Incorrect installation or servicing due to ignoring of the instruction will cause harm or damage, and the seriousness is classified by the following indications.

 WARNING	This indication shows the possibility of causing death or serious injury.
 CAUTION	This indication shows the possibility of causing injury or damage to properties.

- The items to be followed are classified by the symbols:

	This symbol denotes item that is PROHIBITED from doing.
---	---







- Carry out test running to confirm that no abnormality occurs after the servicing. Then, explain to user the operation, care and maintenance as stated in instructions. Please remind the customer to keep the operating instructions for future reference.

 WARNING	
1. Do not modify the machine, part, material during repairing service.	
2. If wiring unit is supplied as repairing part, do not repair or connect the wire even only partial wire break. Exchange the whole wiring unit.	
3. Do not wrench the fasten terminal. Pull it out or insert it straightly.	
4. Engage authorized dealer or specialist for installation and servicing. If installation or servicing done by the user is defective, it will cause water leakage, electrical shock or fire.	
5. Install according to this installation instructions strictly. If installation is defective, it will cause water leakage, electric shock or fire.	
6. Use the attached accessories parts and specified parts for installation and servicing. Otherwise, it will cause the set to fall, water leakage, fire or electrical shock.	
7. Install at a strong and firm location which is able to withstand the set's weight. If the strength is not enough or installation is not properly done, the set will drop and cause injury.	
8. For electrical work, follow the local national wiring standard, regulation and the installation instruction. An independent circuit and single outlet must be used. If electrical circuit capacity is not enough or defect found in electrical work, it will cause electrical shock or fire.	
9. This equipment is strongly recommended to install with Earth Leakage Circuit Breaker (ELCB) or Residual Current Device (RCD). Otherwise, it may cause electrical shock and fire in case equipment breakdown or insulation breakdown.	
10. Do not use joint cable for indoor/outdoor connection cable. Use the specified indoor/outdoor connection cable, refer to installation instruction CONNECT THE CABLE TO THE INDOOR UNIT and connect tightly for indoor/outdoor connection. Clamp the cable so that no external force will be acted on the terminal. If connection or fixing is not perfect, it will cause heat up or fire at the connection.	
11. Wire routing must be properly arranged so that control board cover is fixed properly. If control board cover is not fixed perfectly, it will cause heat-up or fire at the connection point of terminal, fire or electrical shock.	
12. When install or relocate air conditioner, do not let any substance other than the specified refrigerant, eg. air etc. mix into refrigeration cycle (piping). (Mixing of air etc. will cause abnormal high pressure in refrigeration cycle and result in explosion, injury etc.).	
13. Do not install outdoor unit near handrail of veranda. When installing air-conditioner unit at veranda of high rise building, child may climb up to outdoor unit and cross over the handrail and causing accident.	
14. This equipment must be properly earthed. Earth line must not be connected to gas pipe, water pipe, earth of lightning rod and telephone. Otherwise, it may cause electric shock in case equipment breakdown or insulation breakdown.	
15. Keep away from small children, the thin film may cling to nose and mouth and prevent breathing.	
16. Do not use unspecified cord, modified cord, joint cord or extension cord for power supply cord. Do not share the single outlet with other electrical appliances. Poor contact, poor insulation or over current will cause electrical shock or fire.	
17. Tighten the flare nut with torque wrench according to specified method. If the flare nut is over-tightened, after a long period, the flare may break and cause refrigerant gas leakage.	
18. For R410A models, when connecting the piping, do not use any existing (R22) pipes and flare nuts. Using such same may cause abnormally high pressure in the refrigeration cycle (piping), and possibly result in explosion and injury. Use only R410A materials. Thickness of copper pipes used with R410A must be more than 0.8mm. Never use copper pipes thinner than 0.8mm. It is desirable that the amount of residual oil is less than 40 mg/10m.	

 **WARNING**

- | | |
|---|---|
| 19. During installation, install the refrigerant piping properly before run the compressor. (Operation of compressor without fixing refrigeration piping and valves at opened condition will caused suck-in of air, abnormal high pressure in refrigeration cycle and result in explosion, injury etc). | |
| 20. During pump down operation, stop the compressor before remove the refrigeration piping. (Removal of compressor while compressor is operating and valves are opened will cause suck-in of air, abnormal high pressure in refrigeration cycle and result in explosion, injury etc.) | |
| 21. After completion of installation or service, confirm there is no leakage or refrigerant gas. It may generate toxic gas when the refrigerant contacts with fire. | |
| 22. Ventilate if there is refrigerant gas leakage during operation. It may cause toxic gas when refrigerant contacts with fire. | |
| 23. Do not insert your fingers or other objects into the unit, high speed rotating fan may cause injury. |  |
| 24. Must not use other parts except original parts described in catalog and manual. | |

 **CAUTION**

- | | |
|--|---|
| 1. Do not install the unit at place where leakage of flammable gas may occur. In case gas leaks and accumulates at surrounding of the unit, it may cause fire. |  |
| 2. Carry out drainage piping as mentioned in installation instructions. If drainage is not perfect, water may enter the room and damage the furniture. | |
| 3. Tighten the flare nut with torque wrench according to specified method. If the flare nut is over-tightened, after a long period, the flare may break and cause refrigerant gas leakage. | |
| 4. Do not touch outdoor unit air inlet and aluminium fin. It may cause injury. |  |
| 5. Select an installation location which is easy for maintenance. | |
| 6. Pb free solder has a higher melting point than standard solder; typically the melting point is 50°F – 70°F (30°C – 40°C) higher. Please use a high temperature solder iron. In case of the soldering iron with temperature control, please set it to 700 ± 20°F (370 ± 10°C). Pb free solder will tend to splash when heated too high (about 1100°F / 600°C). | |
| 7. Power supply connection to the air conditioner. Connect the power supply cord of the air conditioner to the mains using one of the following methods.
Power supply point shall be the place where there is ease for access for the power disconnection in case of emergency. In some countries, permanent connection of this room air conditioner to the power supply is prohibited.
i. Power supply connection to the receptacle using a power plug. Use an approved 15/16A (3/4~1.75HP) or 16A (2.0HP) or 20A (2.5HP) or 25A (3.0HP) power plug with earth pin for the connection to the socket.
ii. Power supply connection to a circuit breaker for the permanent connection. Use an approved 16A (3/4~2.0HP) or 20A (2.5HP) or 25A (3.0HP) circuit breaker for the permanent connection. It must be a double pole switch with a minimum 3.0 mm contact gap. | |
| 8. Do not release refrigerant during piping work for installation, servicing, reinstallation and during repairing a refrigerant parts. Take care of the liquid refrigerant, it may cause frostbite. |  |
| 9. Installation or servicing work: It may need two people to carry out the installation or servicing work. | |
| 10. Do not install this appliance in a laundry room or other location where water may drip from the ceiling, etc. |  |
| 11. Do not sit or step on the unit, you may fall down accidentally. |  |
| 12. Do not touch the sharp aluminium fins or edges of metal parts.
If you are required to handle sharp parts during installation or servicing, please wear hand glove.
Sharp parts may cause injury. |  |

2. Specification

Model		Indoor	CS-QE9MKE, CS-WE9MKE		
		Outdoor	CU-QE9MKE		
Performance Test Condition		EUROEVENT			
Power Supply		Phase, Hz	Single, 50		
		V	230		
		Min.	Mid.	Max.	
Cooling	Capacity	kW	0.85	2.50	3.00
		BTU/h	2900	8530	10200
		kcal/h	730	2150	2580
	Running Current	A	-	2.6	-
	Input Power	W	180	540	745
	Annual Consumption	kWh	-	270	-
	EER	W/W	4.72	4.63	4.03
		Btu/hW	16.11	15.80	13.69
		kcal/hW	4.06	3.98	3.46
	Power Factor	%	-	90	-
	Indoor Noise (H / L / QLo)	dB-A	39 / 26 / 23		
		Power Level dB	55 / - / -		
	Outdoor Noise (H / L / QLo)	dB-A	46 / - / -		
Power Level dB		61 / - / -			
Heating	Capacity	kW	0.85	3.40	5.40
		BTU/h	2900	11600	18400
		kcal/h	730	2920	4640
	Running Current	A	-	3.5	-
	Input Power	W	180	730	1.36k
	COP	W/W	4.72	4.66	3.97
		Btu/hW	16.11	15.89	13.53
		kcal/hW	4.06	4.00	3.41
	Power Factor	%	-	91	-
	Indoor Noise (H / L / QLo)	dB-A	40 / 27 / 24		
		Power Level dB	56 / - / -		
	Outdoor Noise (H / L / QLo)	dB-A	47 / - / -		
		Power Level dB	62 / - / -		
Low Temp.: Capacity (kW) / I.Power (W) / COP		3.91 / 1.20 / 3.26			
Extr Low Temp.: Capacity (kW) / I.Power (W) / COP		3.13 / 1.29 / 2.43			
Max Current (A) / Max Input Power (W)		6.3 / 1.36k			
Starting Current (A)		3.5			
Compressor	Type	Scroll Motor			
	Motor Type	Brushless (4 poles)			
	Output Power	W	750		

Indoor Fan	Type		Cross-Flow Fan		
	Material		ASG20K1		
	Motor Type		Transistor (8-poles)		
	Input Power		W	47.3	
	Output Power		W	40	
	Speed	QLo	Cool	rpm	680
			Heat	rpm	750
		Lo	Cool	rpm	750
			Heat	rpm	800
		Me	Cool	rpm	930
Heat			rpm	1010	
Hi		Cool	rpm	1120	
		Heat	rpm	1230	
SHi	Cool	rpm	1180		
	Heat	rpm	1320		
Outdoor Fan	Type		Propeller Fan		
	Material		PP		
	Motor Type		DC Motor (8-poles)		
	Input Power		W	-	
	Output Power		W	40	
	Speed	Hi	Cool	rpm	800
			Heat	rpm	790
Moisture Removal		L/h (Pt/h)	1.5 (3.2)		
Indoor Airflow	QLo	Cool	m ³ /min (ft ³ /min)	6.9 (243)	
		Heat	m ³ /min (ft ³ /min)	7.3 (256)	
	Lo	Cool	m ³ /min (ft ³ /min)	7.6 (268)	
		Heat	m ³ /min (ft ³ /min)	7.7 (273)	
	Me	Cool	m ³ /min (ft ³ /min)	9.4 (332)	
		Heat	m ³ /min (ft ³ /min)	9.8 (345)	
	Hi	Cool	m ³ /min (ft ³ /min)	11.3 (400)	
		Heat	m ³ /min (ft ³ /min)	11.9 (420)	
SHi	Cool	m ³ /min (ft ³ /min)	11.9 (421)		
	Heat	m ³ /min (ft ³ /min)	12.8 (451)		
Outdoor Airflow	Hi	Cool	m ³ /min (ft ³ /min)	29.8 (1050)	
		Heat	m ³ /min (ft ³ /min)	29.4 (1040)	

Refrigeration Cycle	Control Device		Expansion Valve	
	Refrigerant Oil	cm ³	RB68A or Freol Alpha68M (400)	
	Refrigerant Type	g (oz)	R410A, 930 (32.8)	
Dimension	Height(I/D / O/D)	mm (inch)	290 (11-7/16) / 540 (21-9/32)	
	Width (I/D / O/D)	mm (inch)	870 (34-9/32) / 780 (30-23/32)	
	Depth (I/D / O/D)	mm (inch)	204 (8-1/16) / 289 (11-13/32)	
Weight	Net (I/D / O/D)	kg (lb)	9 (20) / 35 (77)	
Piping	Pipe Diameter (Liquid / Gas)	mm (inch)	6.35 (1/4) / 9.52 (3/8)	
	Standard length	m (ft)	5.0 (16.4)	
	Length range (min – max)	m (ft)	3 (9.8.) ~ 15 (49.2)	
	I/D & O/D Height different	m (ft)	5.0 (16.4)	
	Additional Gas Amount	g/m (oz/ft)	20 (0.2)	
	Length for Additional Gas	m (ft)	7.5 (24.6)	
Drain Hose	Inner Diameter	mm	16	
	Length	mm	650	
Indoor Heat Exchanger	Fin Material		Aluminium (Pre Coat)	
	Fin Type		Slit Fin	
	Row x Stage x FPI		2 x 15 x 19	
	Size (W x H x L)	mm	610 x 315 x 25.4	
Outdoor Heat Exchanger	Fin Material		Aluminium (Blue Coated)	
	Fin Type		Corrugated Fin	
	Row x Stage x FPI		2 x 24 x 17	
	Size (W x H x L)	mm	36.4 x 504 x 725:713	
Air Filter	Material		Polypropelene	
	Type		One-touch	
Power Supply			Outdoor Power Supply	
Power Supply Cord		A	Nil	
Thermostat			Electronic Contol	
Protection Device			Electronic Contol	
			DRY BULB	WET BULB
Indoor Operation Range	Cooling	Maximum	32	23
	Heating	Minimum	16	11
	Cooling	Maximum	30	-
	Heating	Minimum	16	-
	+8/10°C HEAT	Maximum	10	-
		Minimum	8	-
Outdoor Operation Range	Cooling	Maximum	43	26
	Heating	Minimum	-15	-
	Cooling	Maximum	24	18
	Heating	Minimum	-15	-
	+8/10°C HEAT	Maximum	-	-
		Minimum	-15	-

- Cooling capacities are based on indoor temperature of 27°C DRY BULB (80.6°F DRY BULB), 19.0°C WET BULB (66°F WET BULB) and outdoor air temperature of 35°C DRY BULB (95°F DRY BULB), 24°C WET BULB (75.2°F WET BULB)
- Heating capacities are based on indoor temperature of 20°C Dry Bulb (68°F Dry Bulb) and outdoor air temperature of 7°C Dry Bulb (44.6°F Dry Bulb), 6°C Wet Bulb (42.8°F Wet Bulb)
- Heating low temperature capacity, Input Power and COP measured at 230 V, indoor temperature 20°C, outdoor 2/1°C
- Heating extreme low temperature capacity, Input Power and COP measured at 230 V, indoor temperature 20°C, outdoor -7/-8°C
- Specifications are subjected to change without prior notice for further improvement.
- Maximum heating capacity shown are the values based on powerful operation.
- If the EUROEVENT Certified models can be operated under the “extra-low” temperature condition, -7°C DB and -8°C WB temperature with rated voltage 230V shall be used.
- The annual consumption is calculated by multiplying the input power by an average of 500 hours per year in cooling mode.

Model		Indoor	CS-QE12MKE, CS-WE12MKE			
		Outdoor	CU-QE12MKE			
Performance Test Condition		EUROEVENT				
Power Supply		Phase, Hz	Single, 50			
		V	230			
		Min.	Mid.	Max.		
Cooling	Capacity	kW	0.85	3.50	4.00	
		BTU/h	2900	11900	13600	
		kcal/h	730	3010	3440	
	Running Current	A	-	4.3	-	
	Input Power	W	185	910	1.17k	
	Annual Consumption	kWh	-	455	-	
	EER	W/W	4.59	3.85	3.42	
		Btu/hW	15.68	13.08	11.62	
		kcal/hW	3.95	3.31	2.94	
	Power Factor	%	-	92	-	
	Indoor Noise (H / L / QLo)	dB-A	42 / 29 / 26			
		Power Level dB	58 / - / -			
	Outdoor Noise (H / L / QLo)	dB-A	48 / - / -			
Power Level dB		63 / - / -				
Heating	Capacity	kW	0.85	4.00	6.60	
		BTU/h	2900	13600	22500	
		kcal/h	730	3440	5680	
	Running Current	A	-	4.5	-	
	Input Power	W	185	960	1.85k	
	COP	W/W	4.59	4.17	3.57	
		Btu/hW	15.68	14.17	12.16	
		kcal/hW	3.95	3.58	3.07	
	Power Factor	%	-	93	-	
	Indoor Noise (H / L / QLo)	dB-A	42 / 33 / 30			
		Power Level dB	58 / - / -			
	Outdoor Noise (H / L / QLo)	dB-A	50 / - / -			
		Power Level dB	65 / - / -			
Low Temp.: Capacity (kW) / I.Power (W) / COP		4.78 / 1.64 / 2.91				
Extr Low Temp.: Capacity (kW) / I.Power (W) / COP		3.86 / 1.74 / 2.22				
Max Current (A) / Max Input Power (W)		8.4 / 1.85k				
Starting Current (A)		4.5				
Compressor	Type	Scroll Motor				
	Motor Type	Brushless (4 poles)				
	Output Power	W	750			

Indoor Fan	Type			Cross-Flow Fan	
	Material			ASG20K1	
	Motor Type			Transistor (8-poles)	
	Input Power		W	47.3	
	Output Power		W	40	
	Speed	QLo	Cool	rpm	760
			Heat	rpm	950
		Lo	Cool	rpm	850
			Heat	rpm	1010
		Me	Cool	rpm	1050
			Heat	rpm	1150
Hi		Cool	rpm	1260	
		Heat	rpm	1300	
SHi	Cool	rpm	1320		
	Heat	rpm	1340		
Outdoor Fan	Type			Propeller Fan	
	Material			PP	
	Motor Type			DC Motor (8-poles)	
	Input Power		W	-	
	Output Power		W	40	
	Speed	Hi	Cool	rpm	840
			Heat	rpm	820
Moisture Removal		L/h (Pt/h)		2.0 (4.2)	
Indoor Airflow	QLo	Cool	m ³ /min (ft ³ /min)	7.5 (265)	
		Heat	m ³ /min (ft ³ /min)	9.4 (329)	
	Lo	Cool	m ³ /min (ft ³ /min)	8.4 (297)	
		Heat	m ³ /min (ft ³ /min)	9.9 (350)	
	Me	Cool	m ³ /min (ft ³ /min)	10.4 (367)	
		Heat	m ³ /min (ft ³ /min)	11.3 (398)	
	Hi	Cool	m ³ /min (ft ³ /min)	12.5 (440)	
		Heat	m ³ /min (ft ³ /min)	12.8 (450)	
	SHi	Cool	m ³ /min (ft ³ /min)	13.1 (461)	
		Heat	m ³ /min (ft ³ /min)	13.2 (464)	
Outdoor Airflow	Hi	Cool	m ³ /min (ft ³ /min)	31.0 (1090)	
		Heat	m ³ /min (ft ³ /min)	30.2 (1070)	

Refrigeration Cycle	Control Device		Expansion Valve	
	Refrigerant Oil	cm ³	RB68A or Freol Alpha68M (400)	
	Refrigerant Type	g (oz)	R410A, 970 (34.2)	
Dimension	Height(I/D / O/D)	mm (inch)	290 (11-7/16) / 540 (21-9/32)	
	Width (I/D / O/D)	mm (inch)	870 (34-9/32) / 780 (30-23/32)	
	Depth (I/D / O/D)	mm (inch)	204 (8-1/16) / 289 (11-13/32)	
Weight	Net (I/D / O/D)	kg (lb)	9 (20) / 35 (77)	
Piping	Pipe Diameter (Liquid / Gas)	mm (inch)	6.35 (1/4) / 9.52 (3/8)	
	Standard length	m (ft)	5.0 (16.4)	
	Length range (min – max)	m (ft)	3 (9.8.) ~ 15 (49.2)	
	I/D & O/D Height different	m (ft)	5.0 (16.4)	
	Additional Gas Amount	g/m (oz/ft)	20 (0.2)	
	Length for Additional Gas	m (ft)	7.5 (24.6)	
Drain Hose	Inner Diameter	mm	16	
	Length	mm	650	
Indoor Heat Exchanger	Fin Material		Aluminium (Pre Coat)	
	Fin Type		Slit Fin	
	Row x Stage x FPI		2 x 15 x 21	
	Size (W x H x L)	mm	610 x 315 x 25.4	
Outdoor Heat Exchanger	Fin Material		Aluminium (Blue Coated)	
	Fin Type		Corrugated Fin	
	Row x Stage x FPI		2 x 24 x 17	
	Size (W x H x L)	mm	36.4 x 504 x 725:713	
Air Filter	Material		Polypropelene	
	Type		One-touch	
Power Supply			Outdoor Power Supply	
Power Supply Cord		A	Nil	
Thermostat			Electronic Contol	
Protection Device			Electronic Contol	
			DRY BULB	
Indoor Operation Range	Cooling	Maximum	32	23
	Heating	Minimum	16	11
	Cooling	Maximum	30	-
	Heating	Minimum	16	-
	+8/10°C HEAT	Maximum	10	-
		Minimum	8	-
Outdoor Operation Range	Cooling	Maximum	43	26
	Heating	Minimum	-15	-
	Cooling	Maximum	24	18
	Heating	Minimum	-15	-
	+8/10°C HEAT	Maximum	-	-
		Minimum	-15	-

- Cooling capacities are based on indoor temperature of 27°C DRY BULB (80.6°F DRY BULB), 19.0°C WET BULB (66°F WET BULB) and outdoor air temperature of 35°C DRY BULB (95°F DRY BULB), 24°C WET BULB (75.2°F WET BULB)
- Heating capacities are based on indoor temperature of 20°C Dry Bulb (68°F Dry Bulb) and outdoor air temperature of 7°C Dry Bulb (44.6°F Dry Bulb), 6°C Wet Bulb (42.8°F Wet Bulb)
- Heating low temperature capacity, Input Power and COP measured at 230 V, indoor temperature 20°C, outdoor 2/1°C
- Heating extreme low temperature capacity, Input Power and COP measured at 230 V, indoor temperature 20°C, outdoor -7/-8°C
- Specifications are subjected to change without prior notice for further improvement.
- Maximum heating capacity shown are the values based on powerful operation.
- If the EUROEVENT Certified models can be operated under the “extra-low” temperature condition, -7°C DB and -8°C WB temperature with rated voltage 230V shall be used.
- The annual consumption is calculated by multiplying the input power by an average of 500 hours per year in cooling mode.

3. Features

- **Inverter Technology**
 - Wider output power range
 - Energy saving
 - More precise temperature control
- **E-ion Air Purifying System with Patrol Sensor**
 - Active e-ions are released to catch dust particles and bring them back the large positively charged filter
- **Environment Protection**
 - Non-ozone depletion substances refrigerant (R410A)
- **Long Installation Piping**
 - Long piping up to 15 meters during single split connection only
- **Easy to use remote control**
- **Quality Improvement**
 - Random auto restart after power failure for safety restart operation
 - Gas leakage protection
 - Prevent compressor reverse cycle
 - Inner protector to protect compressor
 - Noise prevention during soft dry operation
- **Operation Improvement**
 - Quiet mode to reduce the indoor unit operating sound
 - Powerful mode to reach the desired room temperature quickly
 - 24-hour timer setting
 - +8/10°C HEAT operation is designed to provide heating at low temperature settings. It is used in houses unoccupied during winter, for the purpose of protecting equipment or housing appliances which may be destroyed by extreme cold weather.
- **Serviceability Improvement**
 - Breakdown Self Diagnosis function

4. Location of Controls and Components

4.1 Indoor Unit

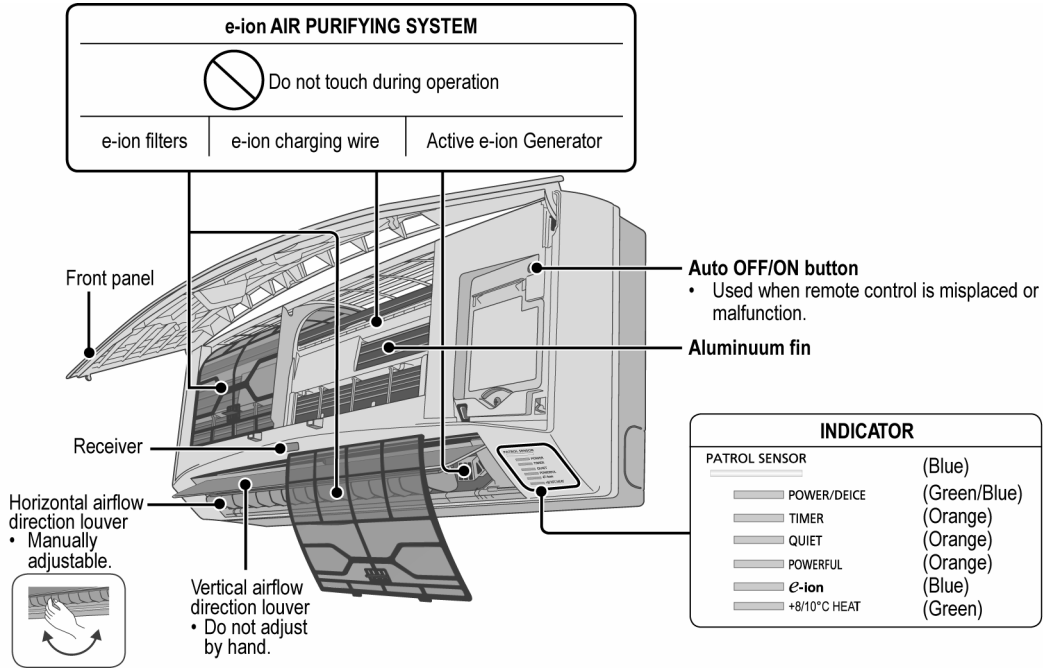

4.2 Outdoor Unit

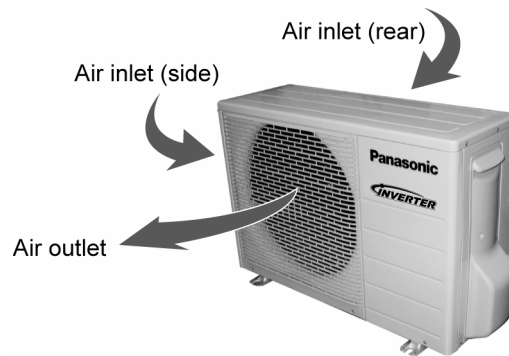

4.3 Remote Control

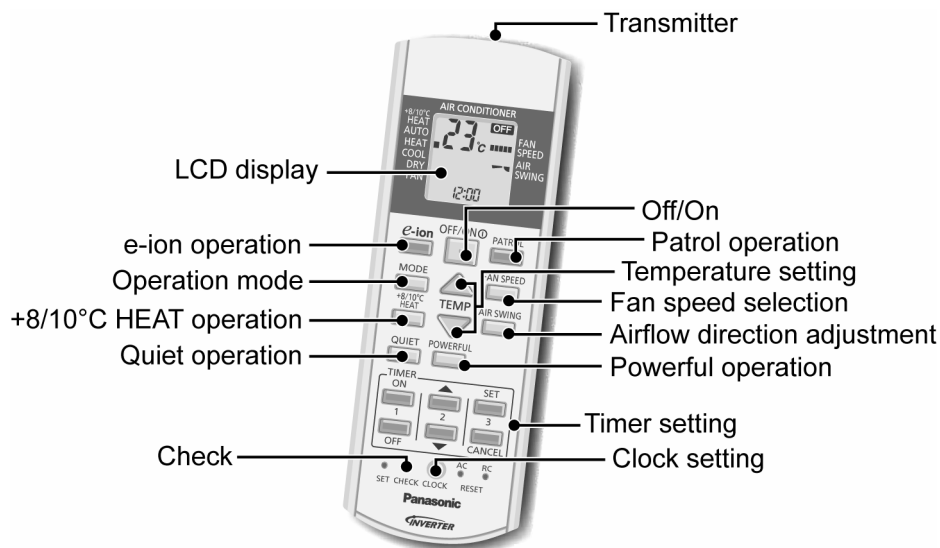

5. Dimensions

5.1 Indoor Unit

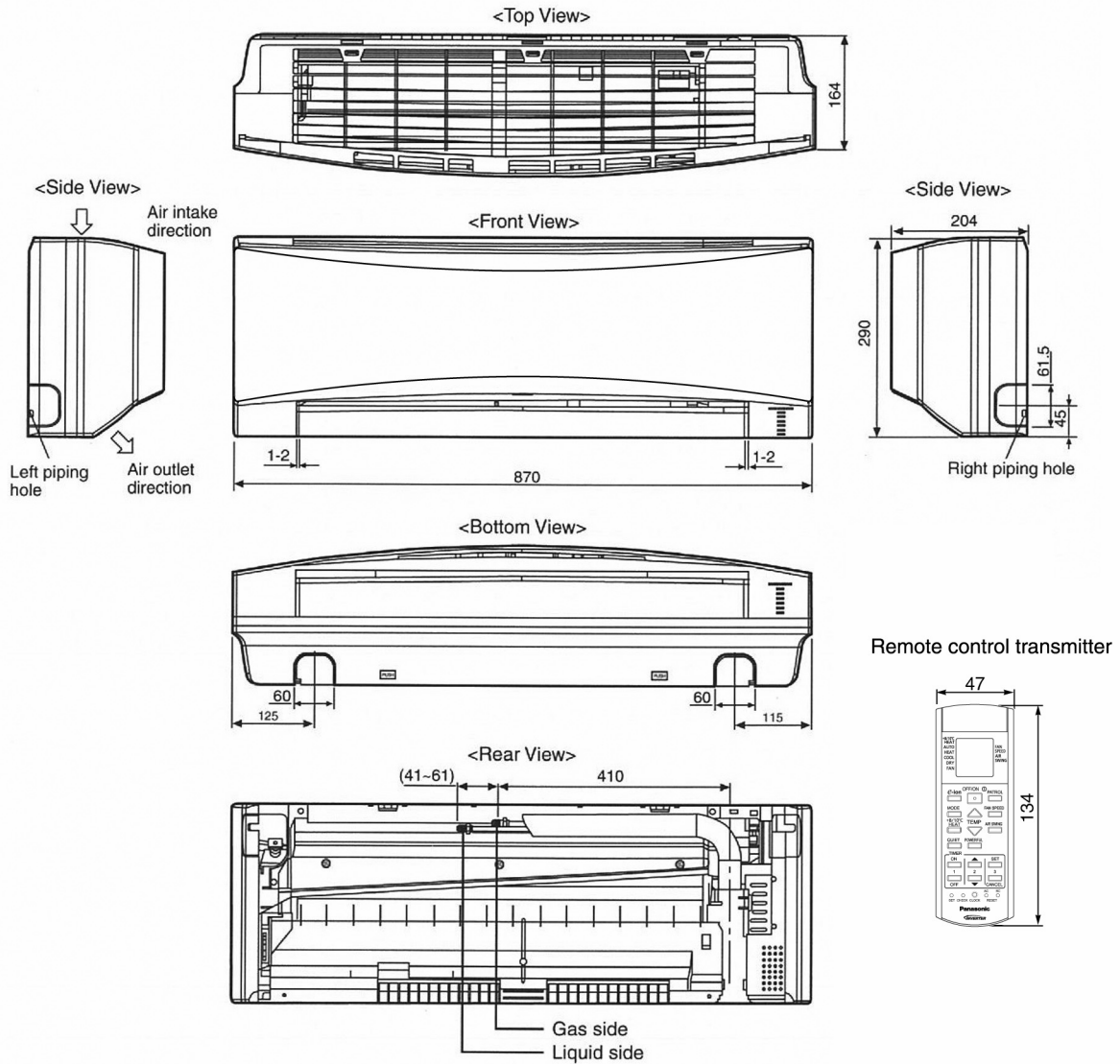

Relative position between the indoor unit and the installation plate <Front View>

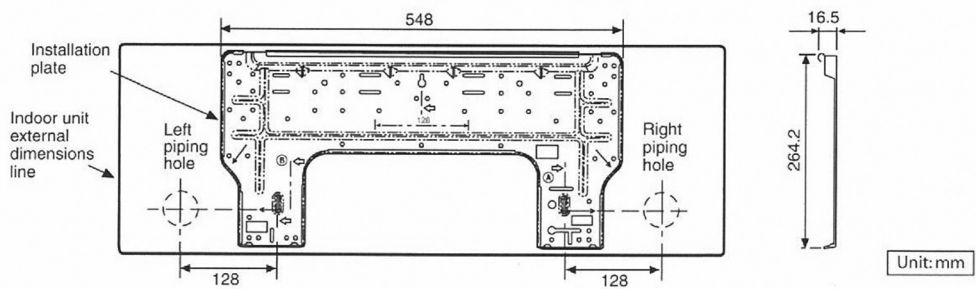

5.2 Outdoor Unit

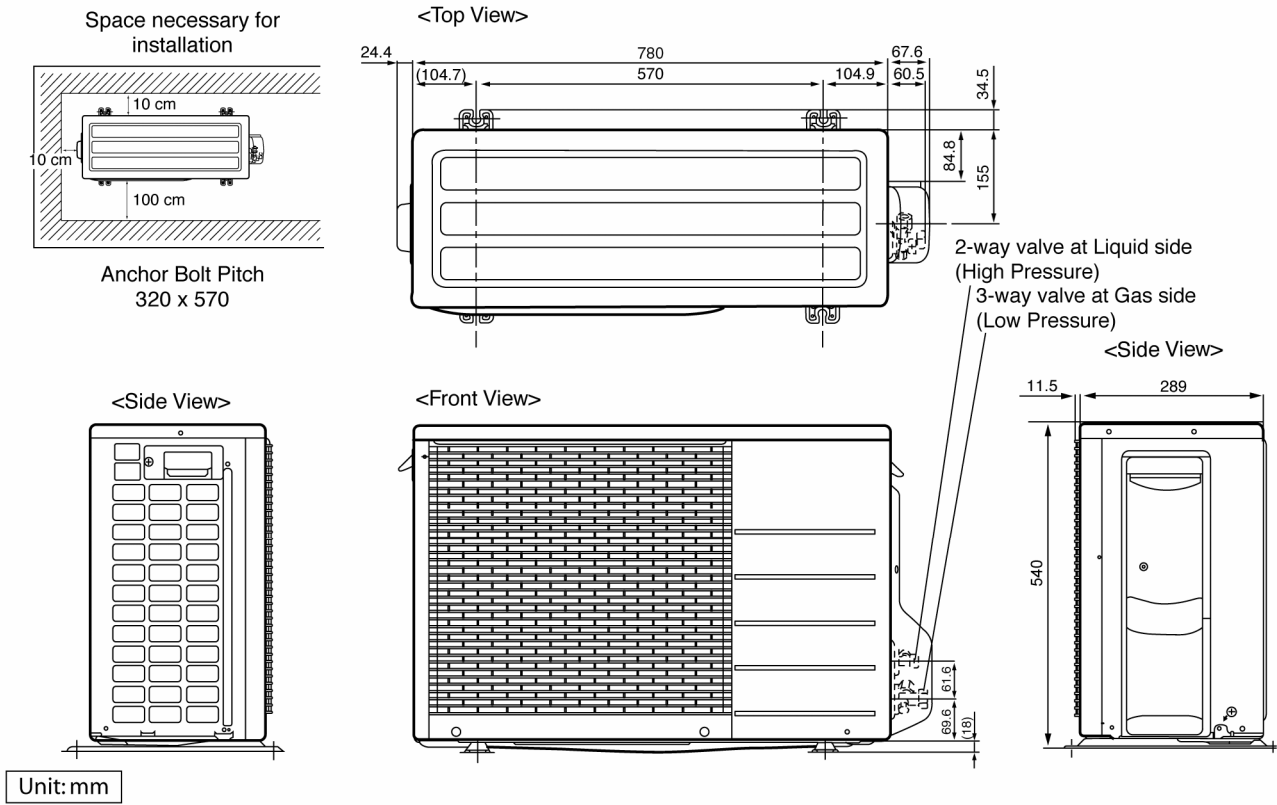

6. Refrigeration Cycle Diagram

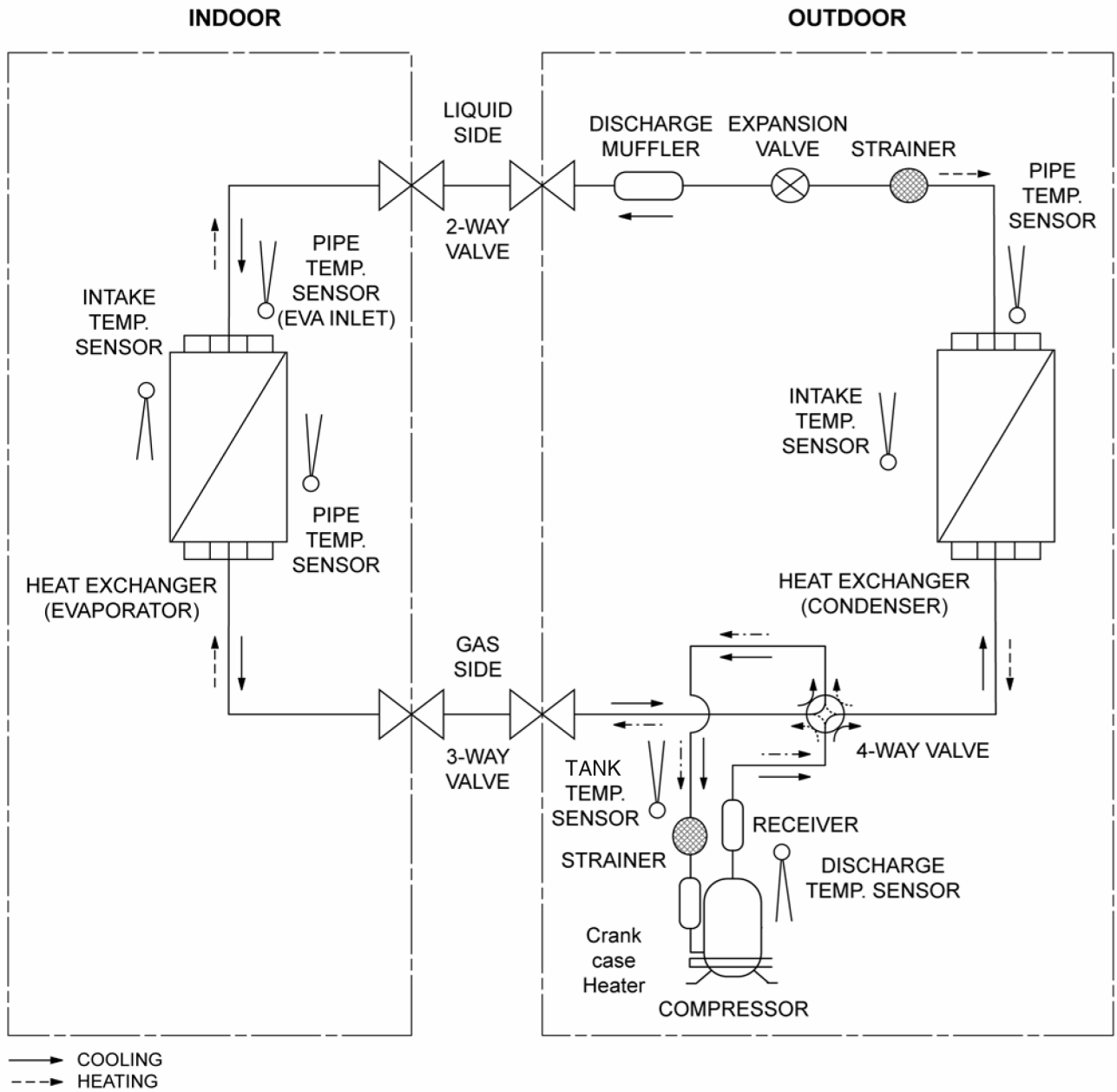

7. Block Diagram

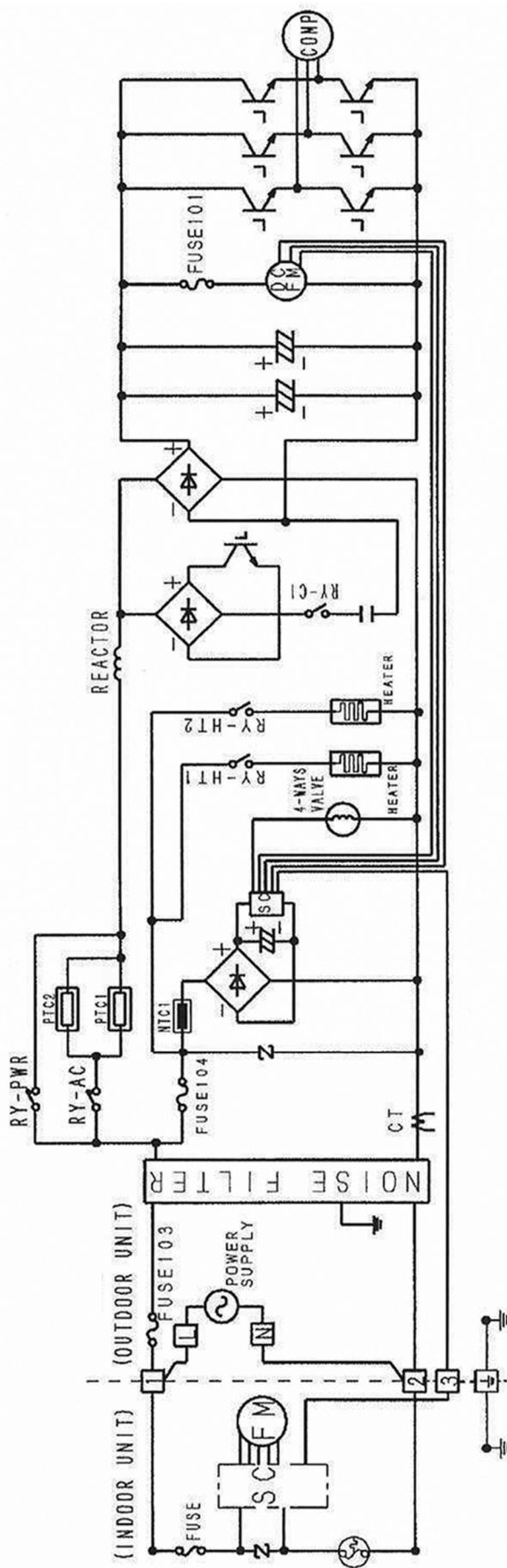

8. Wiring Connection Diagram

8.1 Indoor Unit

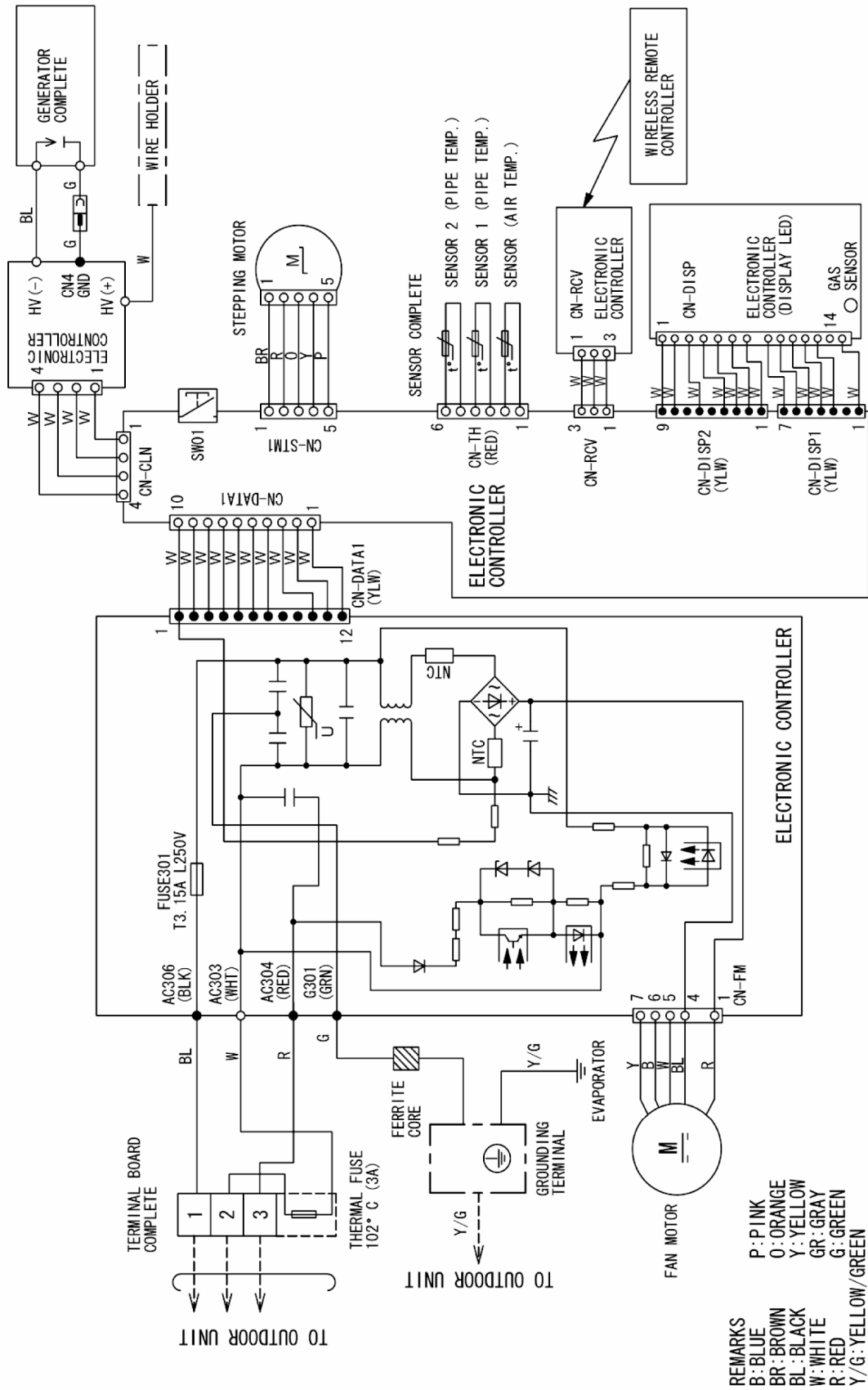

8.2 Outdoor Unit

Resistance of Compressor Windings

CONNECTION	5CS110XBDD04 (r)
U - V	0.902
U - W	0.903
V - W	0.900

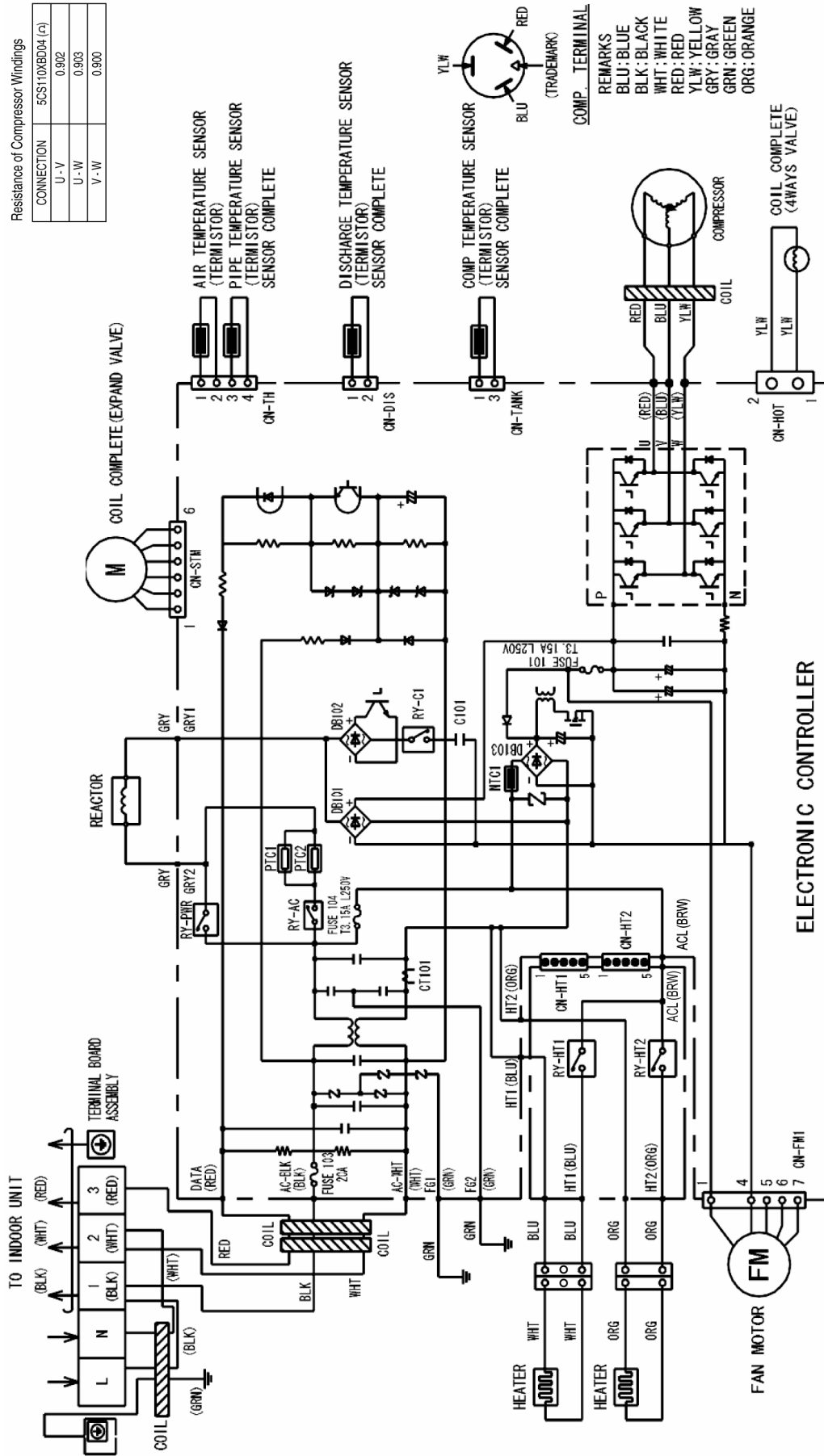

9. Electronic Circuit Diagram

9.1 Indoor Unit

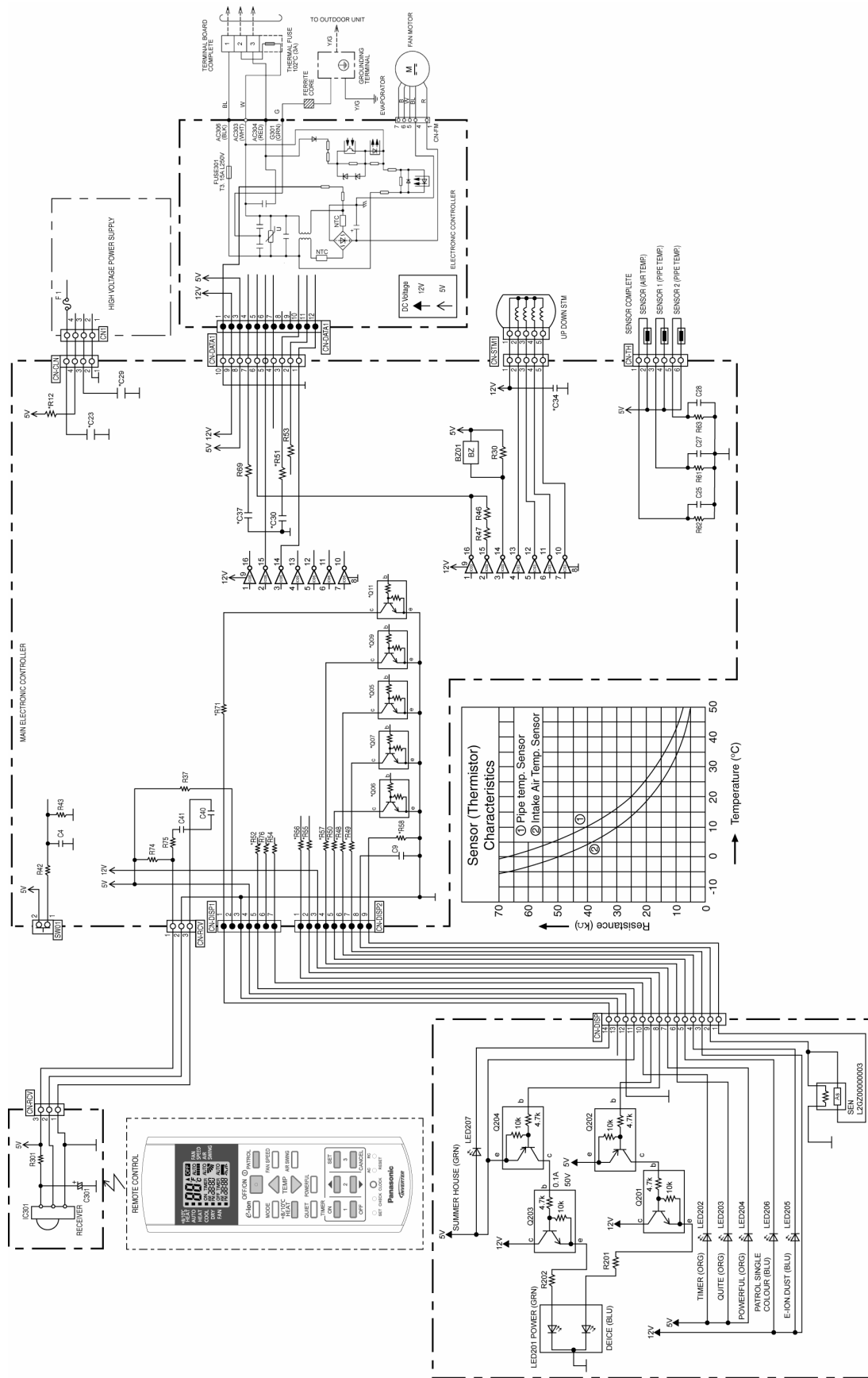

9.2 Outdoor Unit

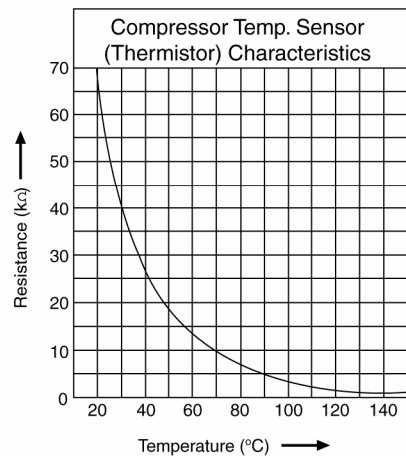
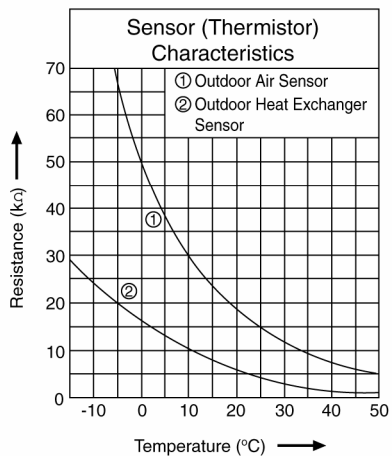
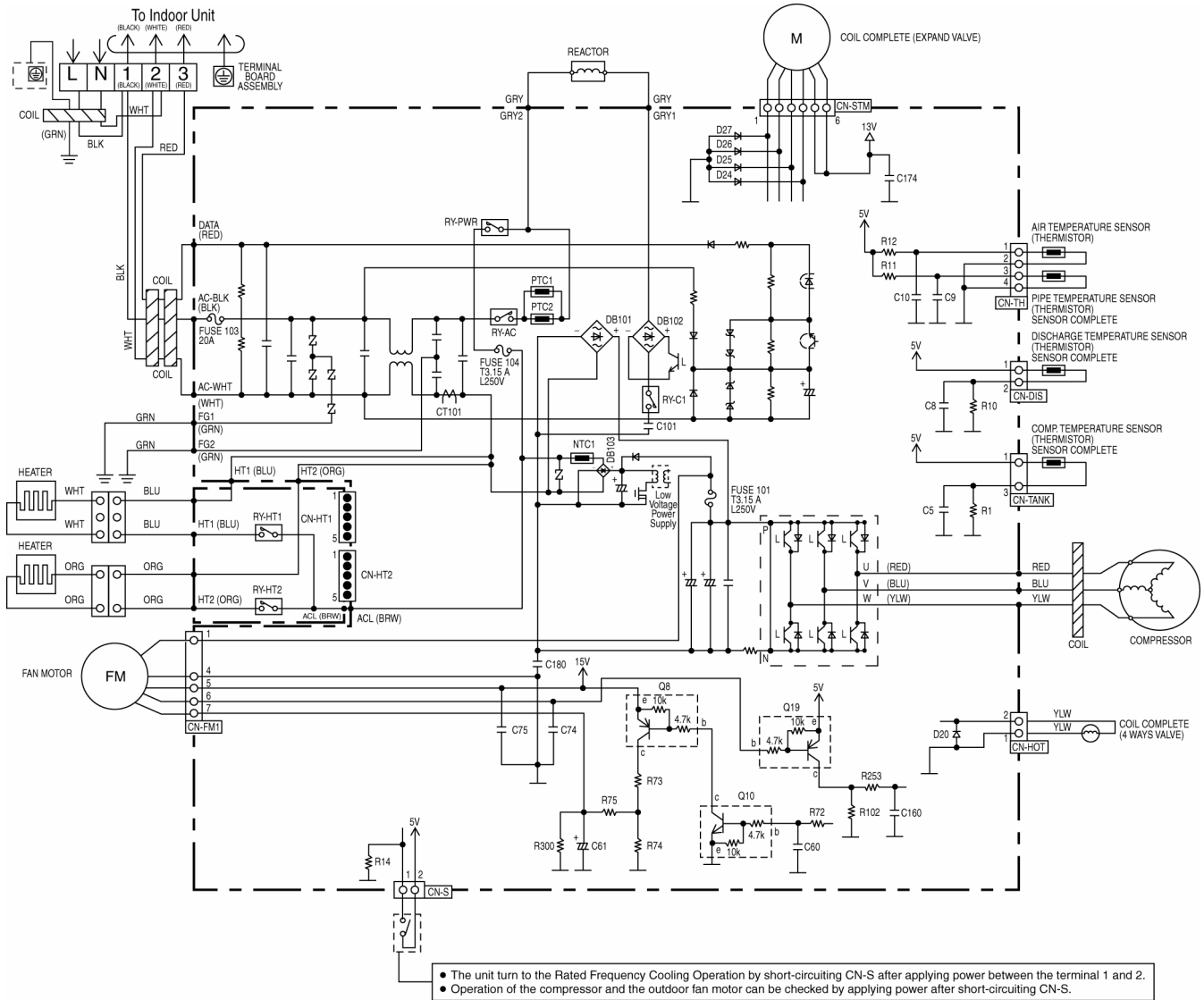

10. Printed Circuit Board

10.1 Indoor Unit

10.1.1 Main Printed Circuit Board

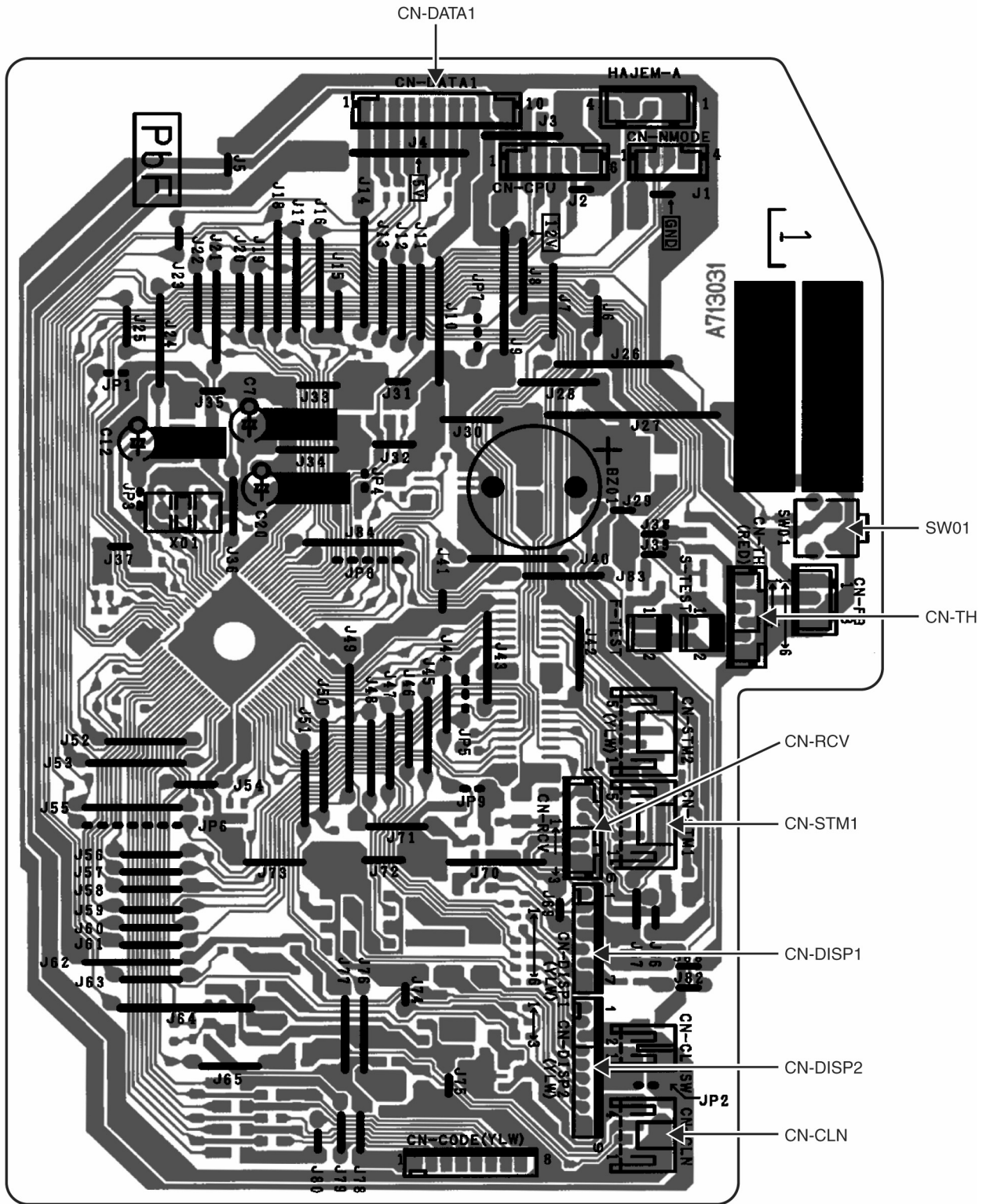

10.1.2 Power Printed Circuit Board

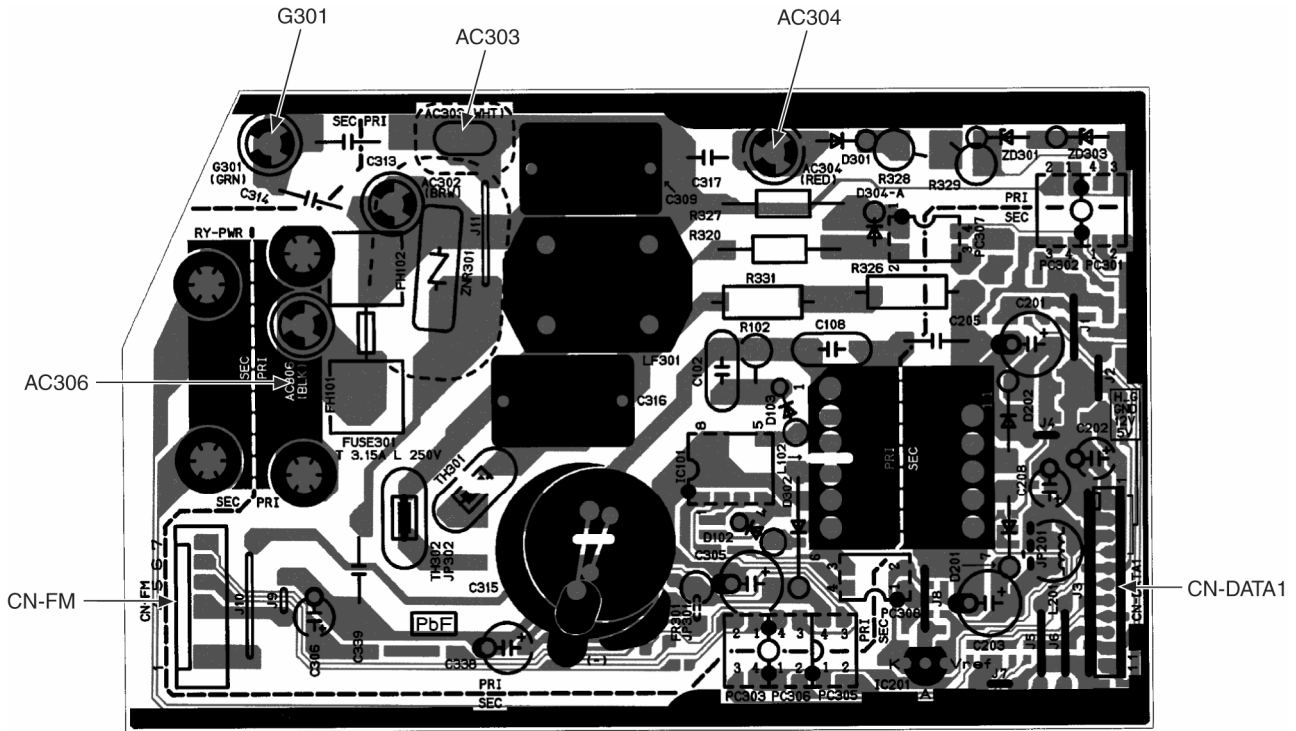

10.1.3 Indicator Printed Circuit Board

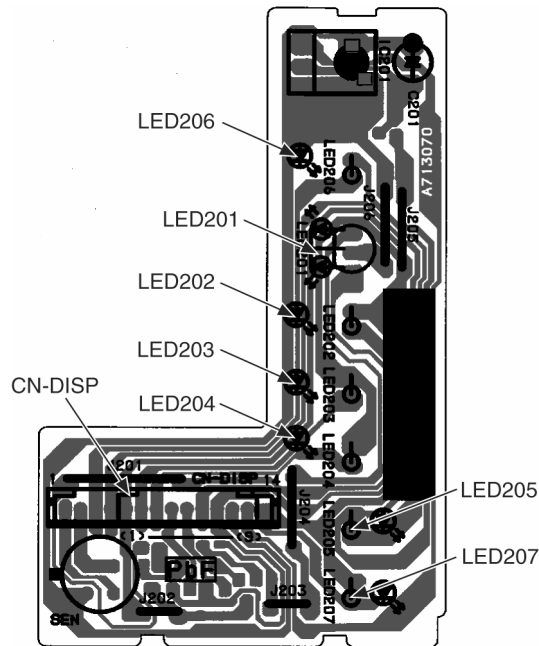

10.1.4 Receiver Printed Circuit Board

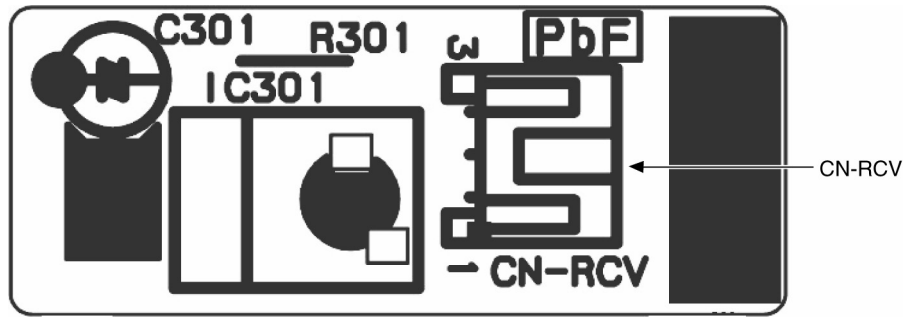

10.1.5 High Voltage Power Supply Printed Circuit Board

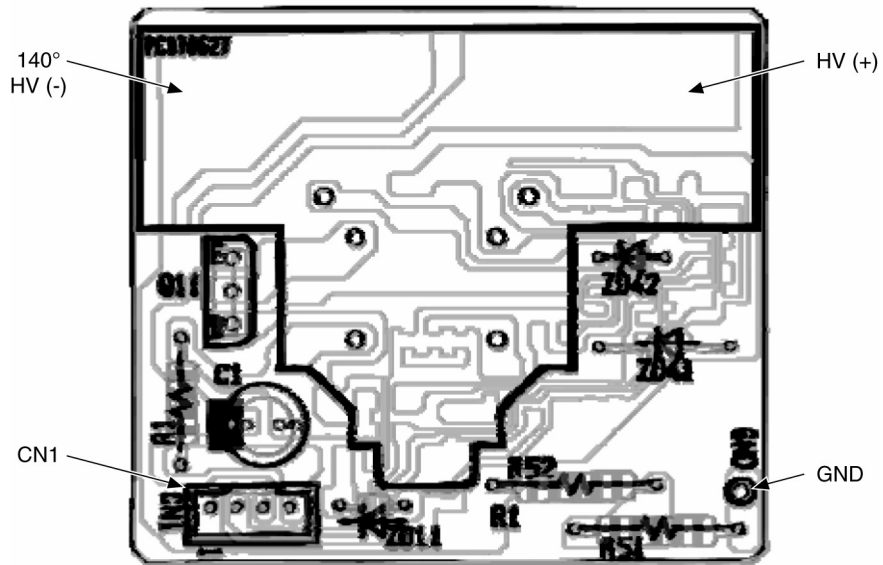

10.2 Outdoor Unit

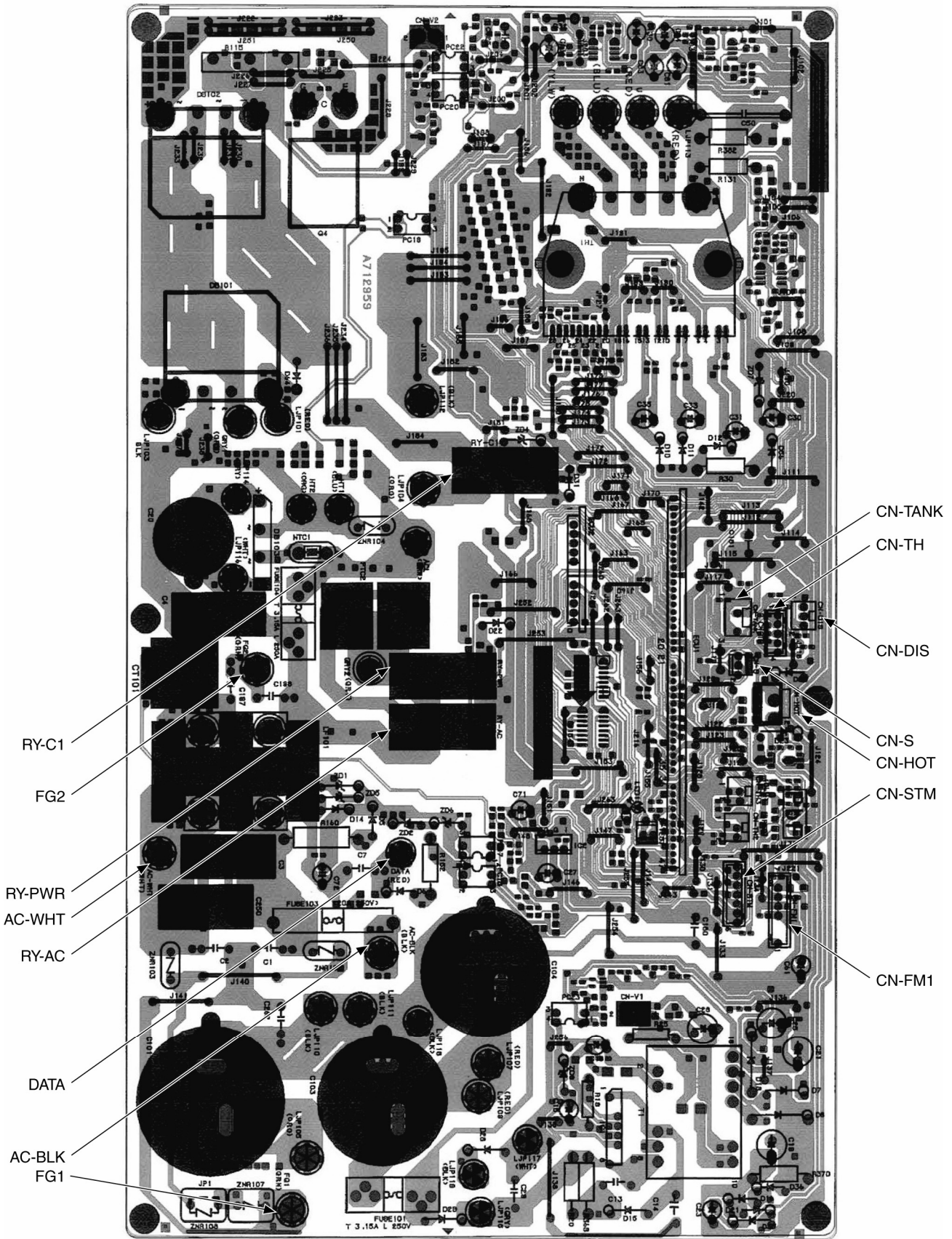

11. Installation Instruction

11.1 Select the Best Location

11.1.1 Indoor Unit

- Do not install the unit in excessive oil fume area such as kitchen, workshop and etc.
- There should not be any heat source or steam near the unit.
- There should not be any obstacles blocking the air circulation.
- A place where air circulation in the room is good.
- A place where drainage can be easily done.
- A place where noise prevention is taken into consideration.
- Do not install the unit near the door way.
- Ensure the spaces indicated by arrows from the wall, ceiling, fence or other obstacles.
- Recommended installation height for indoor unit shall be at least 2.5 m.

11.1.2 Outdoor Unit

- If an awning is built over the unit to prevent direct sunlight or rain, be careful that heat radiation from the condenser is not obstructed.
- There should not be any animal or plant which could be affected by hot air discharged.
- Keep the spaces indicated by arrows from wall, ceiling, fence or other obstacles.
- Do not place any obstacles which may cause a short circuit of the discharged air.
- If piping length is over the [piping length for additional gas], additional refrigerant should be added as shown in the table.

Model	Horse Power (HP)	Piping size		Std. Length (m)	Max. Elevation (m)	Min. Piping Length (m)	Max. Piping Length (m)	Additional Refrigerant (g/m)	Piping Length for add. gas (m)
		Gas	Liquid						
WE9***, QE9***	1.0HP	9.52 mm (3/8")	6.35 mm (1/4")	5	5	3	15	20	7.5
WE12***, QE12***	1.5HP	9.52 mm (3/8")	6.35 mm (1/4")	5	5	3	15	20	7.5

Example: For WE9***

If the unit is installed at 10 m distance, the quantity of additional refrigerant should be 50 g (10-7.5) m x 20 g/m = 50 g.

11.1.3 Indoor/Outdoor Unit Installation Diagram

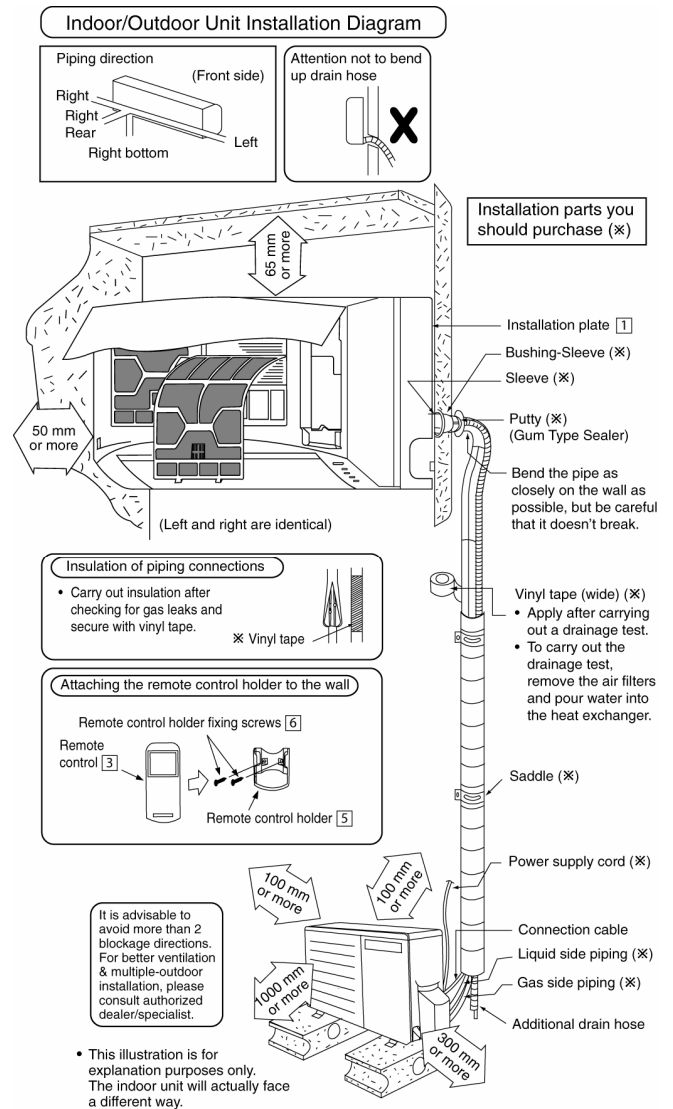

11.2 Indoor Unit

11.2.1 How to Fix Installation Plate

The mounting wall shall be strong and solid enough to prevent it from the vibration.

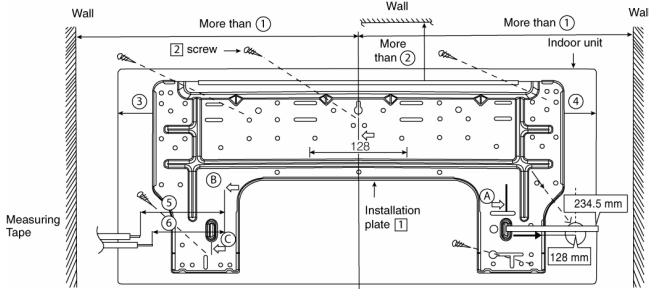

Model	Dimension					
	①	②	③	④	⑤	⑥
WE9***, QE9***	485 mm	82 mm	165 mm	158 mm	127 mm	85 mm
WE12***, QE12***						

The center of installation plate should be at more than ① at right and left of the wall.

The distance from installation plate edge to ceiling should more than ②.

From installation plate left edge to unit's left side is ③.

From installation plate right edge to unit's right side is ④.

- Ⓑ :
- : For left side piping, piping connection for liquid should be about ⑤ from this line.
 - : For left side piping, piping connection for gas should be about ⑥ from this line.

- 1 Mount the installation plate on the wall with 5 screws or more (at least 5 screws). (If mounting the unit on the concrete wall, consider using anchor bolts.)
 - Always mount the installation plate horizontally by aligning the marking-off line with the thread and using a level gauge.
- 2 Drill the piping plate hole with $\varnothing 70$ mm hole-core drill.
 - Line according to the left and right side of the installation plate. The meeting point of the extended line is the center of the hole. Another method is by putting measuring tape at position as shown in the diagram above. The hole center is obtained by measuring the distance namely 128 mm for left and right hole respectively.
 - Drill the piping hole at either the right or the left and the hole should be slightly slanting to the outdoor side.

11.2.2 To Drill a Hole in the Wall and Install a Sleeve of Piping

- 1 Insert the piping sleeve to the hole.
- 2 Fix the bushing to the sleeve.
- 3 Cut the sleeve until it extrudes about 15 mm from the wall.

⚠ Caution

- ❗ When the wall is hollow, please be sure use the sleeve for tube assembly to prevent dangers caused by mice biting the connection cable.

- 4 Finish by sealing the sleeve with putty or caulking compound at the final stage.

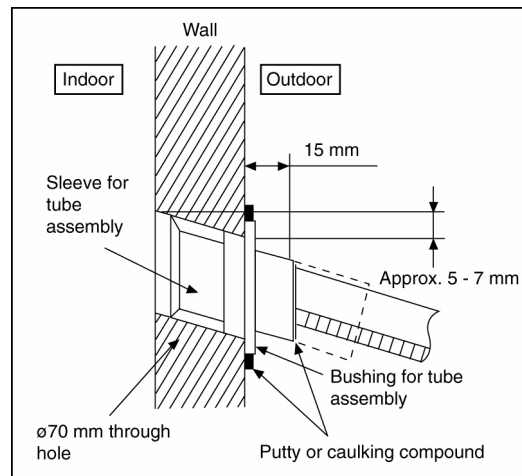

11.2.3 Indoor Unit Installation

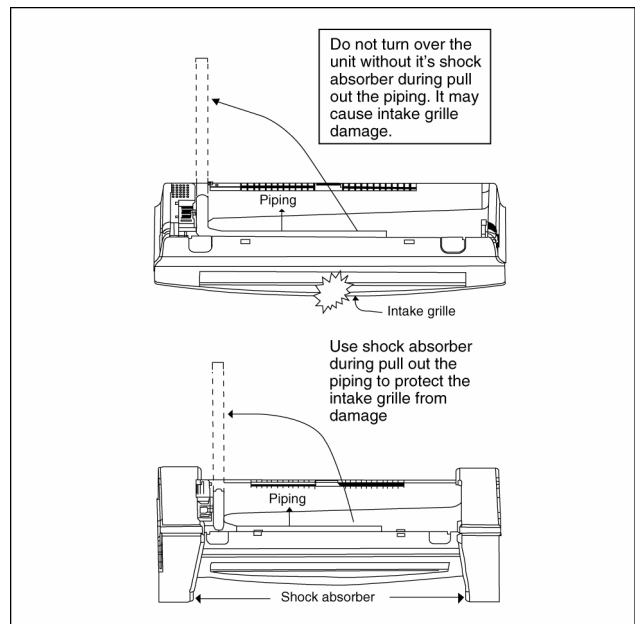

11.2.3.1 For the right rear piping

- Step-1** Pull out the Indoor piping
- Step-2** Install the Indoor Unit
- Step-3** Secure the Indoor Unit
- Step-4** Insert the connection cable

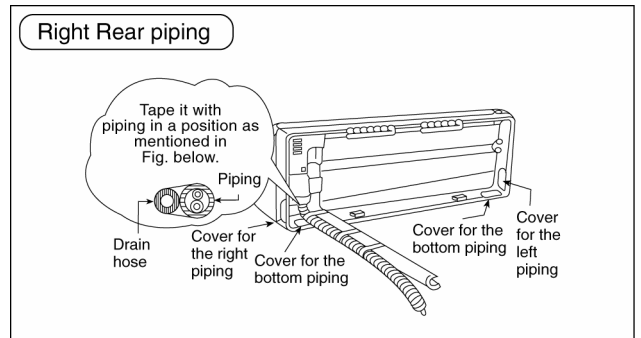

11.2.3.2 For the right and right bottom piping

- Step-1** Pull out the Indoor piping
- Step-2** Install the Indoor Unit
- Step-3** Insert the connection cable
- Step-4** Secure the Indoor Unit

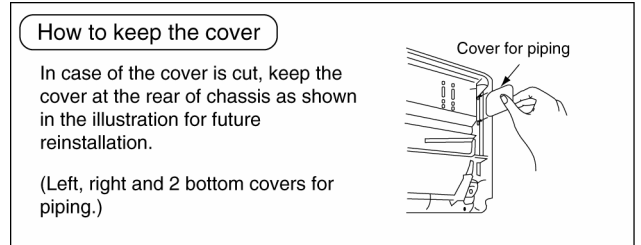

11.2.3.3 For the embedded piping

- Step-1** Replace the drain hose
- Step-2** Bend the embedded piping
 - Use a spring bender or equivalent to bend the piping so that the piping is not crushed.
- Step-3** Pull the connection cable into Indoor Unit
 - The inside and outside connection cable can be connected without removing the front grille.
- Step-4** Cut and flare the embedded piping
 - When determining the dimensions of the piping, slide the unit all the way to the left on the installation plate.
 - Refer to the section "Cutting and flaring the piping".
- Step-5** Install the Indoor Unit
- Step-6** Connect the piping
 - Please refer to "Connecting the piping" column in outdoor unit section. (Below steps are done after connecting the outdoor piping and gas-leakage confirmation.)
- Step-7** Insulate and finish the piping
 - Please refer to "Insulation of piping connection" column as mentioned in indoor/outdoor unit installation.
- Step-8** Secure the Indoor Unit

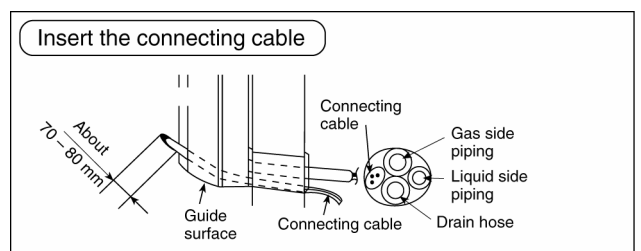
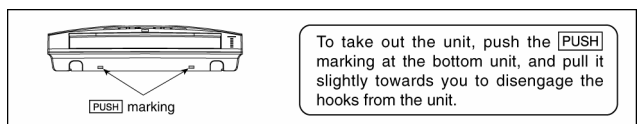
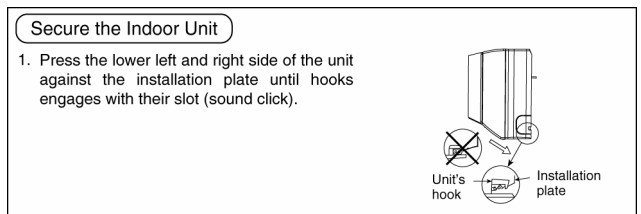
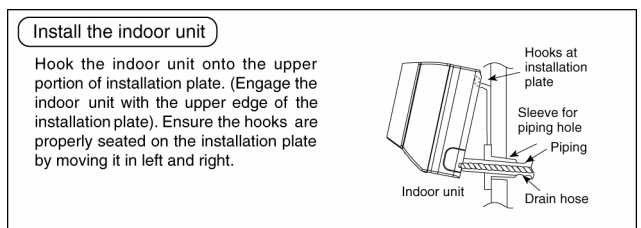
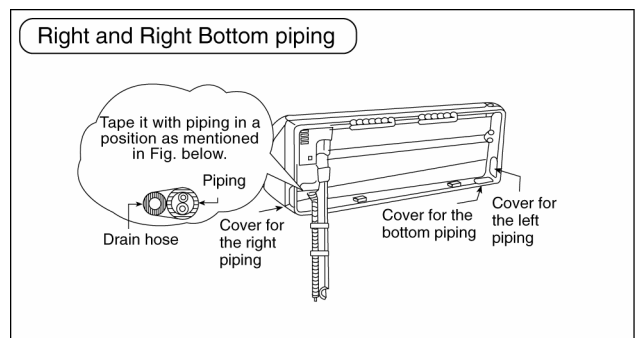

(This can be used for left rear piping and bottom piping also.)

Replace the drain hose

Rear view for left piping installation

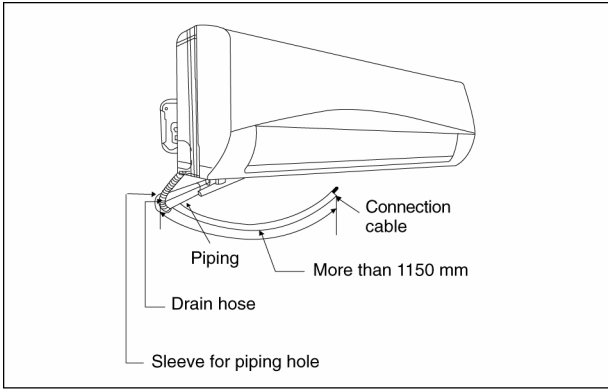
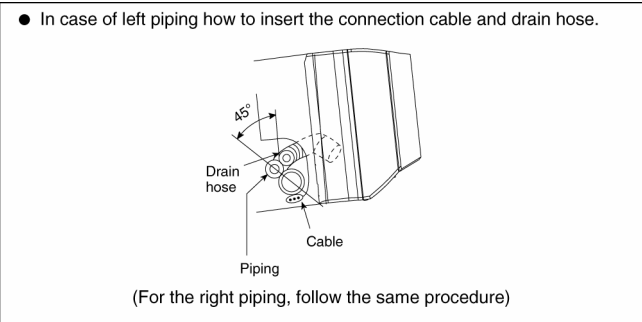
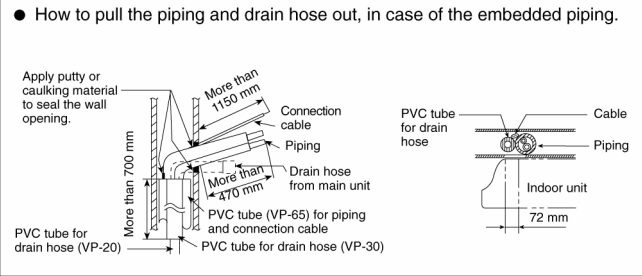
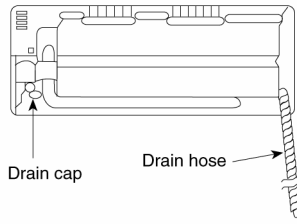

11.2.4 Connect the Cable to the Indoor Unit

- 1 The inside and outside connection cable can be connected without removing the front grille.
- 2 **Connection cable** between indoor unit and outdoor unit shall be approved polychloroprene sheathed 4 x 1.5 mm² flexible cord, type designation 245 IEC 57 or heavier cord.
- 3 Bind all the indoor and outdoor connection cable with tape and route the connection cable via the escapement.
- 4 Remove the tapes and connect the connection cable between indoor unit and outdoor unit according to the diagram below.

Terminals on the indoor unit	1	2	3	
Colour of wires				
Terminals on the outdoor unit	1	2	3	

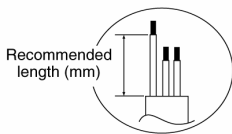

Recommended length (mm)	a	b	c	d
	35	35	35	55

WARNING
This equipment must be properly earthed.

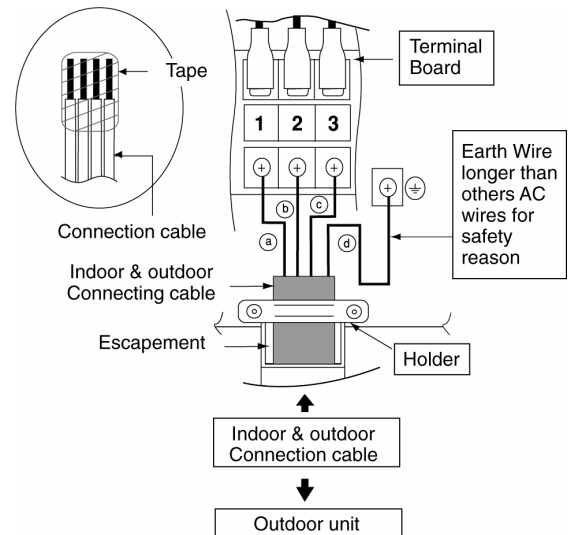

- 5 Secure the connection cable onto the control board with the holder (clammer).
 - Ensure the colour of wires of outdoor unit and the terminal Nos. are the same to the indoor's respectively.
 - Earth wire shall be Yellow/Green (Y/G) in colour and longer than other AC wires for safety reason.

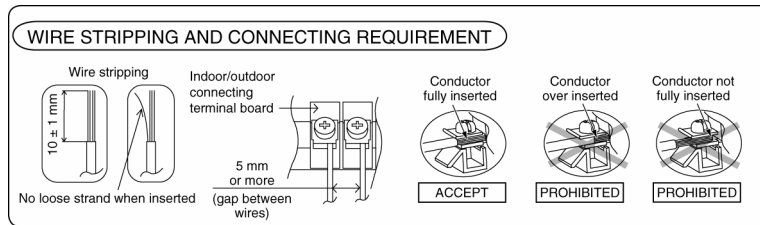

CUTTING AND FLARING THE PIPING

- 1 Please cut using pipe cutter and then remove the burrs.
- 2 Remove the burrs by using reamer. If burrs are not removed, gas leakage may be caused. Turn the piping end down to avoid the metal powder entering the pipe.
- 3 Please make flare after inserting the flare nut onto the copper pipes.

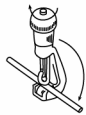

1. To cut

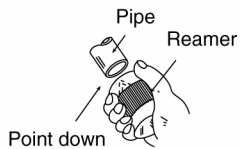

2. To remove burrs

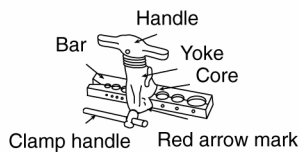

3. To flare

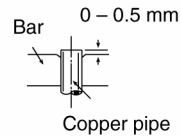

Copper pipe

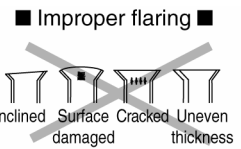

When properly flared, the internal surface of the flare will evenly shine and be of even thickness. Since the flare part comes into contact with the connections, carefully check the flare finish.

11.3 Outdoor Unit

11.3.1 Install the Outdoor Unit

- After selecting the best location, start installation according to Indoor/Outdoor Unit Installation Diagram.
 - Fix the unit on concrete or rigid frame firmly and horizontally by bolt nut ($\varnothing 10$ mm).
 - When installing at roof, please consider strong wind and earthquake. Please fasten the installation stand firmly with bolt or nails.

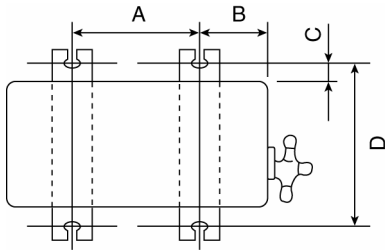

Model	A	B	C	D
QE9***	570 mm	150 mm	18.5 mm	320 mm
QE12***				

11.3.2 Connect Piping

Connecting the piping to indoor

Please make flare after inserting flare nut (locate at joint portion, of tube assembly) onto the copper pipe. (In case of using long piping)

Connect the piping

- Align the center of piping and sufficiently tighten the flare nut with fingers.
- Further tighten the flare nut with torque wrench in specified torque as stated in the table.

Do not overtighten, overtightening may cause gas leakage.	
Piping size	Torque
6.35 mm (1/4")	[18 N•m (1.8 kgf.m)]
9.52 mm (3/8")	[42 N•m (4.3 kgf.m)]
12.7 mm (1/2")	[55 N•m (5.6 kgf.m)]
15.88 mm (5/8")	[65 N•m (6.6 kgf.m)]
19.05 mm (3/4")	[100 N•m (10.2 kgf.m)]

Connecting the piping to outdoor

Decide piping length and then cut by using pipe cutter. Remove burrs from cut edge.

Make flare after inserting the flare nut (locate at valve) onto the copper pipe.

Align center of piping to valves and then tighten with torque wrench to the specified torque as stated in the table.

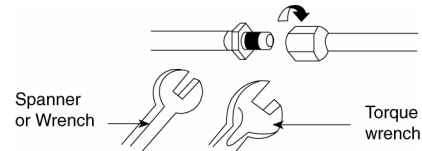

11.3.3 Evacuation of the Equipment

WHEN INSTALLING AN AIR CONDITIONER, BE SURE TO EVACUATE THE AIR INSIDE THE INDOOR UNIT AND PIPES in the following procedure.

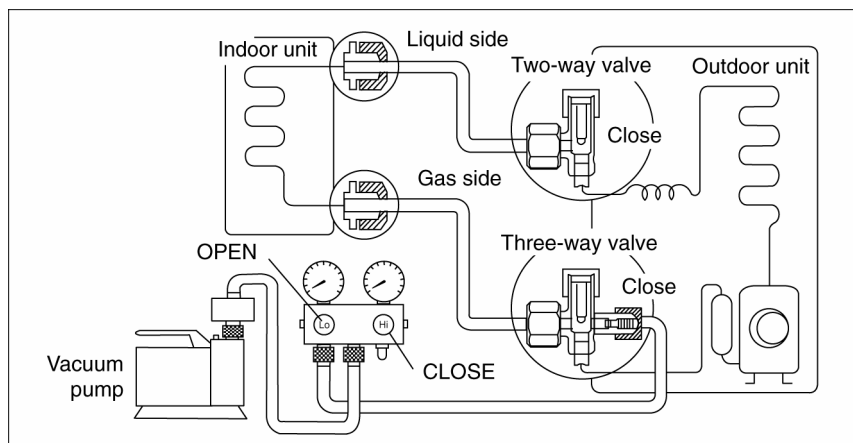

- Connect a charging hose with a push pin to the Low side of a charging set and the service port of the 3-way valve.
 - Be sure to connect the end of the charging hose with the push pin to the service port.
- Connect the center hose of the charging set to a vacuum pump.
- Turn on the power switch of the vacuum pump and make sure that the needle in the gauge moves from 0 cmHg (0 MPa) to -76 cmHg (-0.1 MPa). Then evacuate the air approximately ten minutes.

- 4 Close the Low side valve of the charging set and turn off the vacuum pump. Make sure that the needle in the gauge does not move after approximately five minutes.
Note: BE SURE TO TAKE THIS PROCEDURE IN ORDER TO AVOID REFRIGERENT GAS LEAKAGE.
- 5 Disconnect the charging hose from the vacuum pump and from the service port of the 3-way valve.
- 6 Tighten the service port caps of the 3-way valve at a torque of 18 N•m with a torque wrench.
- 7 Remove the valve caps of both of the 2-way valve and 3-way valve. Position both of the valves to “OPEN” using a hexagonal wrench (4 mm).
- 8 Mount valve caps onto the 2-way valve and the 3-way valve.
 - Be sure to check for gas leakage.

- If gauge needle does not move from 0 cmHg (0 MPa) to -76 cmHg (-0.1 MPa), in the step ③ above take the following measure:
- If the leak stops when the piping connections are tightened further, continue working from step ③.
- If the leak does not stop when the connections are retightened, repair location of leak.
- Do not release refrigerant during piping work for installation and reinstallation.
- Take care of the liquid refrigerant, it may cause frostbite.

11.3.4 Connect the cable to the Outdoor Unit

- 1 Remove the control board cover from the unit by loosening the screw.
- 2 Cable connection to the power supply through Isolating Devices (Disconnecting means).
 - Connect approved type polychloroprene sheathed **power supply cord** 3 x 1.5 mm² (1.0 ~ 1.5HP) type designation 245 IEC 57 or heavier cord to the terminal board, and connect the others end of the cord to Isolating Devices (Disconnecting means).
- 3 **Connection cable** between indoor unit and outdoor unit shall be approved polychloroprene sheathed 4 x 1.5 mm² flexible cord, type designation 245 IEC 57 or heavier cord.
- 4 Connect the power supply cord and connection cable between indoor unit and outdoor unit according to the diagram below.

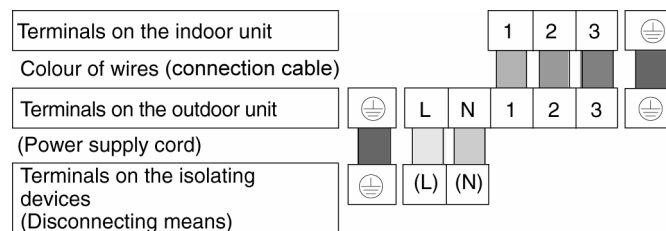
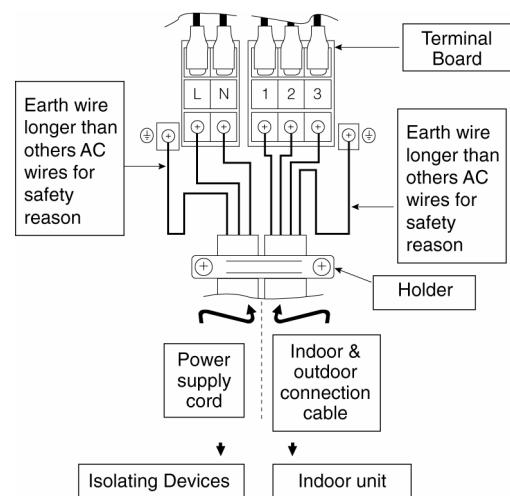

- 5 Secure the power supply cord and connection cable onto the control board with the holder.
- 6 Attach the control board cover back to the original position with the screw.
- 7 For wire stripping and connection requirement, refer to instruction ⑤ of the indoor unit.

⚠ WARNING

⊕ This equipment must be properly earthed.

- Note: Isolating Devices (Disconnecting means) should have minimum 3.0 mm contact gap.
- Earth wire shall be Yellow/Green (Y/G) in colour and longer than the other AC wires for safety reason.

11.3.5 Piping Insulation

- 1 Please carry out insulation at pipe connection portion as mentioned in Indoor/Outdoor Unit Installation Diagram. Please wrap the insulated piping end to prevent water from going inside the piping.
- 2 If drain hose or connecting piping is in the room (where dew may form), please increase the insulation by using POLY-E-FOAM with thickness 6 mm or above.

12. Operation Control

12.1 Basic Function

Inverter control, which equipped with a microcomputer in determining the most suitable operating mode as time passes, automatically adjusts output power for maximum comfort always. In order to achieve the suitable operating mode, the microcomputer maintains the set temperature by measuring the temperature of the environment and performing temperature shifting. The compressor at outdoor unit is operating following the frequency instructed by the microcomputer at indoor unit that judging the condition according to internal setting temperature and intake air temperature.

12.1.1 Internal Setting Temperature

Once the operation starts, remote control setting temperature will be taken as base value for temperature shifting processes. These shifting processes are depending on the air conditioner settings and the operation environment. The final shifted value will be used as internal setting temperature and it is updated continuously whenever the electrical power is supplied to the unit.

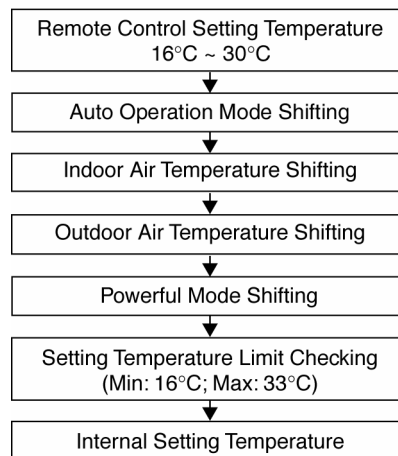

12.1.2 Cooling Operation

12.1.2.1 Thermostat control

- Compressor is OFF when Intake Air Temperature - Internal Setting Temperature < -1.5°C.
- Compressor is ON after waiting for 3 minutes, if the Intake Air Temperature - Internal Setting Temperature > Compressor OFF point.

12.1.3 Soft Dry Operation

12.1.3.1 Thermostat control

- Compressor is OFF when Intake Air Temperature - Internal Setting Temperature < -2.0°C.
- Compressor is ON after waiting for 3 minutes, if the Intake Air Temperature - Internal Setting Temperature > Compressor OFF point.

12.1.4 Heating Operation

12.1.4.1 Thermostat control

- Compressor is OFF when Intake Air Temperature - Internal Setting Temperature > +2.0°C.
- Compressor is ON after waiting for 3 minutes, if the Intake Air Temperature - Internal Setting Temperature < Compressor OFF point.

12.1.5 Automatic Operation

- This mode can be set using remote control and the operation is decided by remote control setting temperature, remote control operation mode, indoor intake air temperature and outdoor air temperature.
- During operation mode judgment, indoor fan motor (with speed of Lo-) and outdoor fan motor are running for 30 seconds to detect the indoor intake and outdoor air temperature. The operation mode is decided based on below chart.

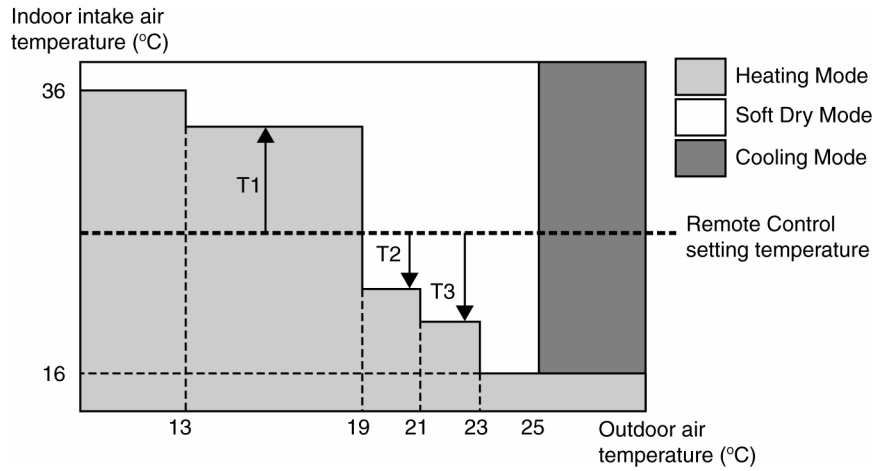

- Every 30 minutes, the indoor and outdoor temperature is judged. Based on remote control setting temperature, the value of T1 will increase up to 10°C, T2 will decrease by 3°C and T3 will decrease up to 8°C.
- The Auto Operation Mode shifting will take place whenever operation mode changed from Cool/Soft Dry to Heating or vice versa.

12.1.6 Fan Operation

- Fan Operation is used to circulate air in a room.
- During operation, indoor fan run continuously but outdoor fan and compressor stop.
- Temperature setting is not applicable.

12.2 Indoor Fan Motor Operation

12.2.1 Basic Rotation Speed (rpm)

- Manual Fan Speed
[Cooling, Dry]
 - Fan motor's number of rotation is determined according to remote control setting.

Remote control	○	○	○	○	○
Tab	Hi	Me+	Me	Me-	Lo

[Heating]

- Fan motor's number of rotation is determined according to remote control setting.

Remote control	○	○	○	○	○
Tab	SHi	Me+	Me	Me-	Lo

- Auto Fan Speed
[Cooling, Dry]
 - According to room temperature and setting temperature, indoor fan speed is determined automatically.
 - The indoor fan will operate according to pattern below.

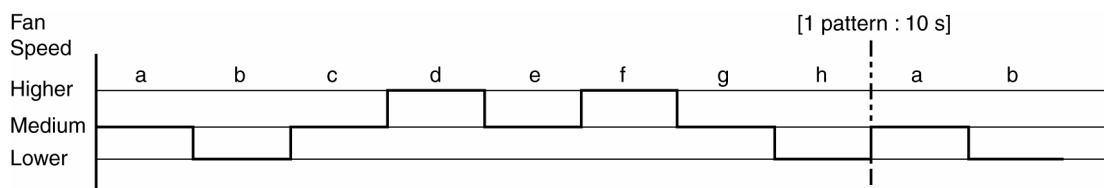

[Fan]

- Indoor fan speed is fixed at predetermined speed.

[Heating]

- According to indoor pipe temperature, automatic heating fan speed is determined as follows.

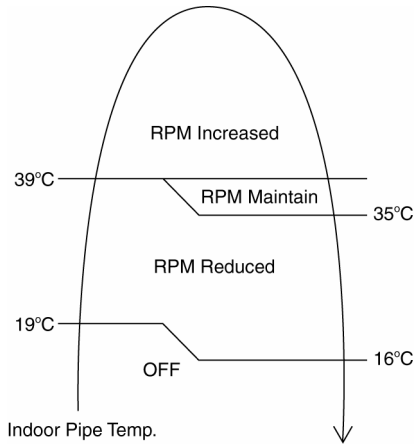

12.2.2 Feedback control

- Immediately after the fan motor started, feedback control is performed once every second.
- During fan motor on, if fan motor feedback ≥ 2550 rpm or < 50 rpm continue for 10 seconds, then fan motor error counter increase, fan motor is then stop and restart. If the fan motor counter becomes 7 times, then H19 - fan motor error is detected. Operation stops and cannot on back.

12.3 Outdoor Fan Motor Operation

Outdoor fan motor is operated with 15 fan speed number of roations. It starts when compressor starts operation and it stops 30 seconds after compressor stops operation.

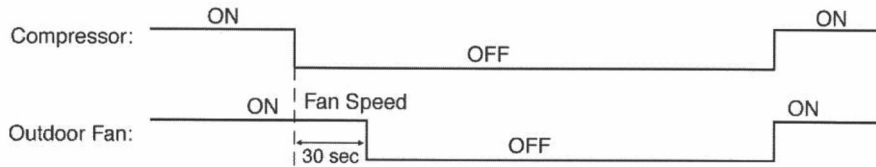

12.4 Airflow Direction

- There are two types of airflow, vertical airflow (directed by horizontal vane) and horizontal airflow (directed by vertical vanes).
- Control of airflow direction can be automatic (angles of direction is determined by operation mode, heat exchanger temperature and intake air temperature) and manual (angles of direction can be adjusted using remote control).

12.4.1 Vertical Flow

Operation Mode	Airflow Direction		Vane Angle (°)				
			1	2	3	4	5
Heating	Auto Heat Exchanger Temperature	A	20				
		B	58				
		C	33				
	Manual		20	33	45	58	70
Cooling and e-ion and Fan	Auto		20 ~ 46				
	Manual		20	27	33	40	46
Soft Dry	Auto		20 ~ 46				
	Manual		20	27	33	40	46

- Automatic vertical airflow direction can be set using remote control; the vane swings up and down within the angles as stated above. For heating mode operation, the angle of the vane depends on the indoor heat exchanger temperature as Figure 1 below. When the air conditioner is stopped using remote control, the vane will shift to close position.
- Manual vertical airflow direction can be set using remote control; the angles of the vane are as stated above and the positions of the vane are as Figure 2 below. When the air conditioner is stopped using remote control, the vane will shift to close position.

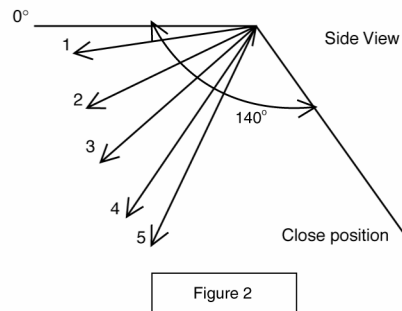
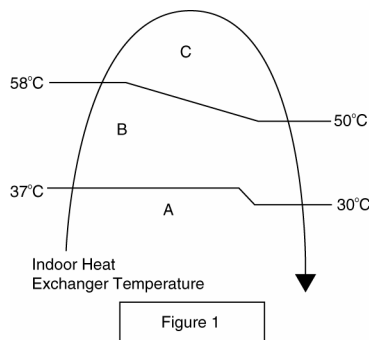

12.4.2 Horizontal Airflow

- The horizontal airflow direction louvers can be adjusted manually by hand.

12.5 Quiet operation (Cooling Mode/Cooling area of Dry Mode)

- Purpose
 - To provide quiet cooling operation compare to normal operation.
- Control condition
 - Quiet operation start condition
 - When “Quiet” button at remote control is pressed. Quiet LED illuminates.
 - Quiet operation stop condition
 - When one of the following conditions is satisfied, quiet operation stops:
 - Powerful button is pressed.
 - Stop by OFF/ON switch.
 - Timer “off” activates.
 - Quiet button is pressed again.
 - When quiet operation is stopped, operation is shifted to normal operation with previous setting.
 - When fan speed is changed, quiet operation is shifted to quiet operation of the new fan speed.
 - When operation mode is changed, quiet operation is shifted to quiet operation of the new mode.
 - During quiet operation, if timer “on” activates, quiet operation maintains.
 - After off, when on back, quiet operation is not memorised.
- Control contents
 - Fan speed is changed from normal setting to quiet setting of respective fan speed. This is to reduce sound of Hi, Me, Lo for 3dB (some models more than 3dB).
 - Fan speed for quiet operation is reduced from setting fan speed.

12.6 Quiet operation (Heating)

- Purpose
 - To provide quiet heating operation compare to normal operation.
- Control condition
 - Quiet operation start condition
 - When “Quiet” button at remote control is pressed. Quiet LED illuminates.

- Quiet operation stop condition
 - When one of the following conditions is satisfied, quiet operation stops:
 - Powerful button is pressed.
 - Stop by OFF/ON switch.
 - Timer “off” activates.
 - Quiet button is pressed again.
 - When quiet operation is stopped, operation is shifted to normal operation with previous setting.
 - When fan speed is changed, quiet operation is shifted to quiet operation of the new fan speed.
 - When operation mode is changed, quiet operation is shifted to quiet operation of the new mode, expect fan mode only.
 - During quiet operation, if timer “on” activates, quiet operation maintains.
 - After off, when on back, quiet operation is not memorised.
- Control contents
 - Fan Speed manual
 - Fan speed is changed from normal setting to quiet setting of respective fan speed. This is to reduce sound of Hi, Me, Lo for 3dB.
 - Fan speed for quiet operation is reduced from setting fan speed.
 - Fan Speed Auto
 - Indoor FM RPM depends on pipe temp sensor of indoor heat exchanger.

12.7 Powerful Mode Operation

- When the powerful mode is selected, the internal setting temperature will shift lower up to 2°C (for Cooling/Soft Dry) or higher up to 3.5°C (for Heating) than remote control setting temperature for 20 minutes to achieve the setting temperature quickly.

12.8 Timer Control

12.8.1 ON Timer Control

- ON timer can be set using remote control, the unit with timer set will start operate earlier than the setting time. This is to provide a comfortable environment when reaching the set ON time.
- 60 minutes before the set time, indoor (at fan speed of Lo-) and outdoor fan motor start operate for 30 seconds to determine the indoor intake air temperature and outdoor air temperature in order to judge the operation starting time.
- From the above judgment, the decided operation will start operate earlier than the set time as shown below.

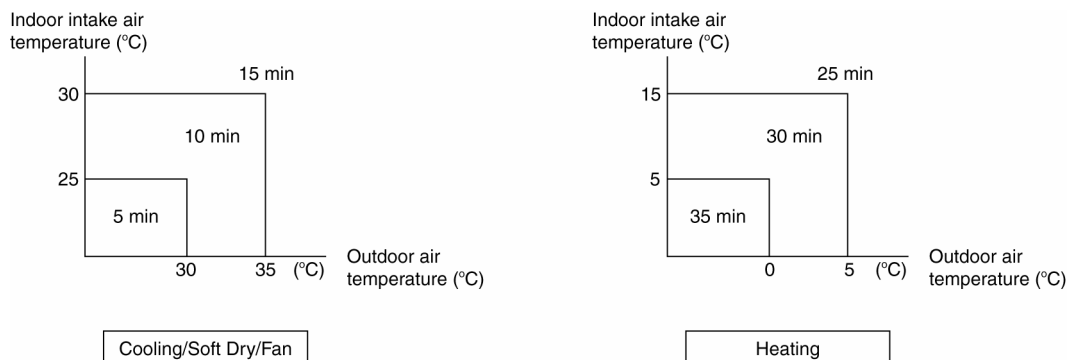

12.8.2 OFF Timer Control

OFF timer can be set using remote control, the unit with timer set will stop operate at set time.

12.9 Auto Restart Control

- When the power supply is cut off during the operation of air conditioner, the compressor will re-operate within three to four minutes (there are 10 patterns between 2 minutes 58 seconds and 3 minutes 52 seconds to be selected randomly) after power supply resumes.
- This type of control is not applicable during ON/OFF Timer setting.

12.10 Indication Panel

LED	POWER/DEICE		TIMER	QUIET	POWERFUL	e-ion	+8/10°C HEAT	PATROL SENSOR
Color	Green	Blue	Orange	Orange	Orange	Blue	Green	Blue
Light ON	Operation ON	Deice Operation	Timer Setting ON	QUIET Mode ON	POWERFUL Mode ON	e-ion ON	+8/10°C HEAT ON	PATROL ON
Light OFF	Operation OFF		Timer Setting OFF	QUIET Mode OFF	POWERFUL Mode OFF	e-ion OFF	+8/10°C HEAT OFF	PATROL OFF

Note:

- If POWER LED is blinking, the possible operation of the unit are Hot Start, operation mode judgment, or ON timer sampling.
- If Timer LED is blinking, there is an abnormality operation occurs.
- If e-ion LED is blinking, there is an abnormality of e-ion occurs.
- If PATROL LED is blinking, there is a gas sensor error detection.

12.11 Patrol Operation

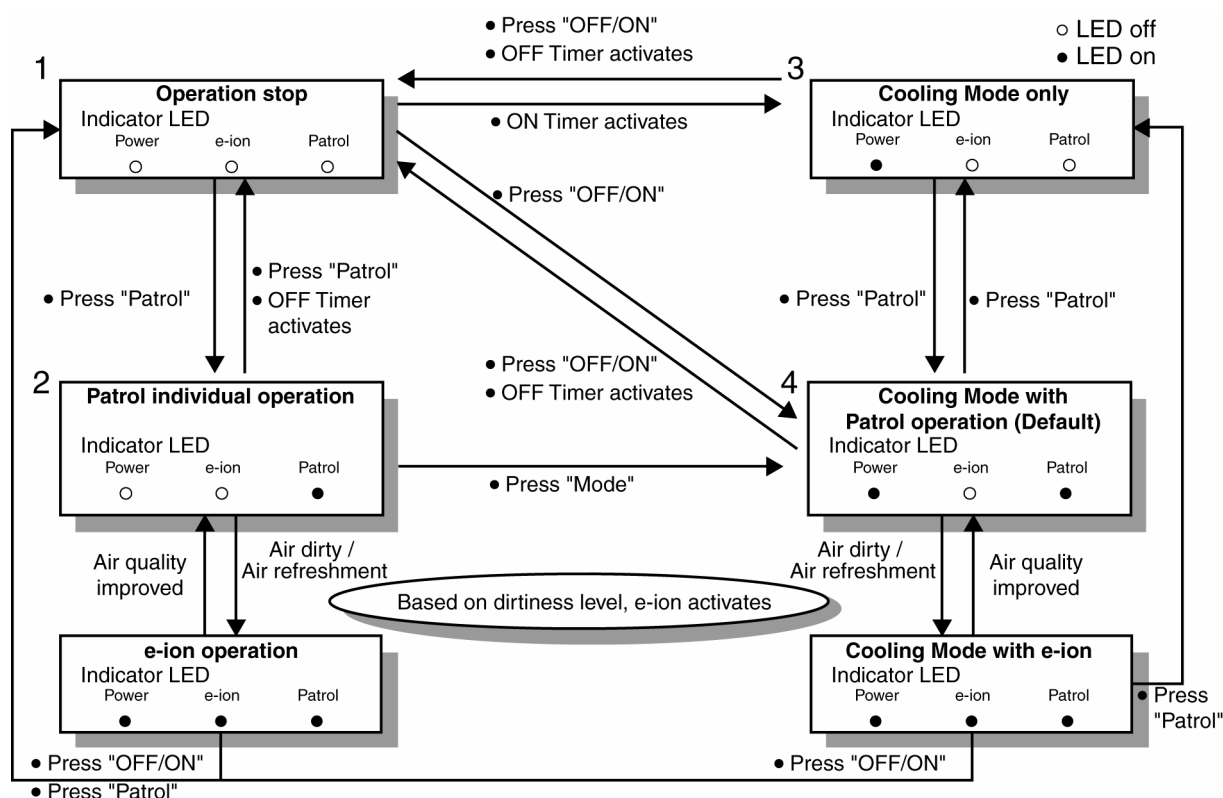

- Purpose
 - To monitor air dirtiness level by using Patrol sensor and to maintain air freshness by activates e-ion operation
- Control Condition
 - Patrol operation starts condition
 - When the unit operation is started with "OFF/ON" button.
 - When the unit stops, "Patrol" button is pressed, Patrol individual operation will start.
 - During cooling only operation, "Patrol" button is pressed.
 - Patrol operation stops condition
 - When any of the following condition is fulfilled:
 - When "OFF/ON" button is pressed.
 - During any operation with Patrol, "Patrol" button is pressed again.
 - When "e-ion" button is pressed.
 - When OFF Timer activates.

- Patrol operation disable
 - To disable the Patrol Operation during unit start (default) with “OFF/ON” button, press “Patrol” button and hold for 5 seconds, then release.
 - To disable the Patrol Operation, press “Patrol” button and hold for 15 seconds, then release.
- Control Content
 - Patrol Sensor Control
 - First 2 minutes from Patrol function activates is stabilization time, during stabilization time, no air dirtiness level is monitored.
The Air Dirtiness level is set to level 2.
 - After that, gas sensor starts to record the resistance value at fixed interval. Higher resistance value indicates cleaner air.
 - The air dirtiness level is monitored by comparing the current resistance value with maximum resistance value from time to time to get the Air Dirtiness Value.
 - There are 3 air dirtiness levels, based on the Air Dirtiness Value:
 - Air Dirtiness level 0: Clean
 - Air Dirtiness level 1: Moderate
 - Air Dirtiness level 2: Contaminated

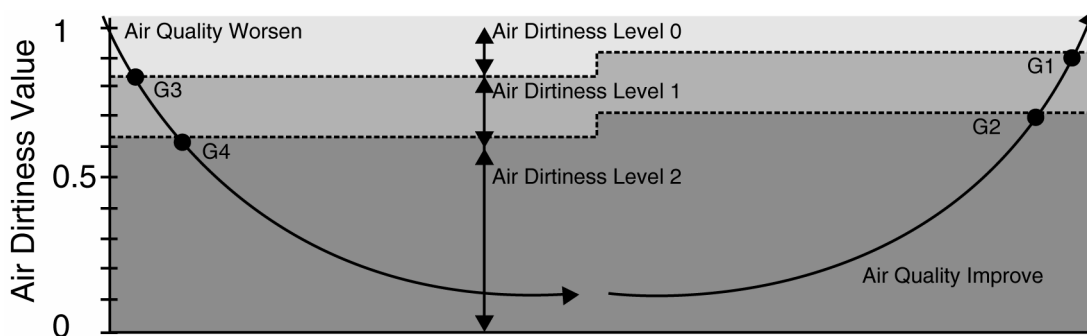

- Dirtiness level sensitivity adjustment
It is possible to change the gas sensor sensitivity, where the Threshold value (G1 ~ G4) will be shifted accordingly:
 - Press and release “SET” button.
 - Press “Timer increment” / “Timer decrement” button to select sensitivity. (Low ↔ Standard (Default) ↔ High)
 - Confirm setting by pressing “Timer Set” button. LCD returned to original display after 2 seconds.
 - LCD returned to original display if remote control does not operate for 30 seconds.

- e-ion Control
 - When dirtiness level is 1 or 2, e-ion operation starts.
 - If dirtiness level improves from level 2 to level 1, the unit carries out level change after 60 seconds.
 - When dirtiness level returns to level 0 continuously for 10 minutes or more, e-ion operation stops.

Dirtiness Level Shift

- For Auto Fan Speed, the fan speed increased based on dirtiness level:

	Dirtiness level	rpm shift	
		Patrol individual operation	Combine operation
e-ion ON	Dirtiness level 0	No change	No change
	Dirtiness level 1	+ 20	+ 20
	Dirtiness level 2	+ 40	+ 40

- Indoor Fan Control
 - During any operation mode combines with Patrol operation, fan speed follows respective operation mode.
 - During Patrol individual operation if e-ion starts, only Auto Fan Speed and no Powerful operation is allowed. Even if “Fan Speed” button is pressed, no signal is sent to air conditioner, and no change on LCD display.
 - During Patrol individual operation if e-ion stops, Indoor Fan stop operation.

- Airflow direction (Horizontal, Vertical) Control
 - During any operation mode combines with Patrol operation, airflow direction follows respective operation mode.
 - During Patrol individual operation if e-ion starts, only Auto Air Swing is allowed. Even if “Air Swing” button is pressed, no signal is sent to air conditioner, and no change on LCD display.
 - During Patrol individual operation if e-ion stops, Airflow direction louver closed.
- Indicator
 - When Patrol operation starts, Patrol Sensor indicator ON.
 - When e-ion operation starts based on dirtiness level, e-ion indicator ON.
- Remote Control Receiving Sound
 - Normal Operation → Patrol Mode : Beep
 - Patrol Mode → Stop : Long Beep
 - Patrol Mode → Normal Operation : Beep
 - Stop → Patrol : Beep
- Timer Control
 - When ON timer activates when unit stops, previous operation resumes and restored last saved patrol operation status.
 - When ON timer activates during any operation, no change and carry on current operation.
 - When OFF timer activates during any operation, all operation stops and the latest patrol operation status is saved.
- Power failure
 - During Patrol individual operation, if power failure occurs, after power resumes, Patrol individual operation resumes immediately.
 - During combination operation, if power failure occurs, after power resumes combination operation resume immediately.
- Error Detection Control
 - The Patrol error detection control starts once the power is supplied to Patrol sensor. However, the error will display when the Patrol operation is ON.
 - Error detection method:
 - If the Patrol sensor feedback is 0V or 5V continuous for 6 hours, Patrol sensor error occurs. However, the error will display only when the Patrol operation is ON.
 - Patrol Sensor Control after error occurs
 - During any operation mode combines with Patrol operation
 - Power supply to Patrol sensor is OFF
 - Air conditioner normal mode operation continues with Patrol LED and Timer LED blinking and “H58” is indicated.
 - Timer LED will always blinking and the Patrol LED continues blinking if the Patrol operation is ON and stops blinking if the patrol operation is OFF.
 - During Patrol individual mode
 - Power supply to Patrol sensor is OFF
 - Patrol LED and Timer LED blinking and “H58” is indicated.
 - Timer LED will always blinking and the Patrol LED continues blinking if the Patrol operation is ON and stops blinking if the Patrol operation is OFF.
 - Error cancel condition:
 - Power supply reset

12.12 e-ion Operation

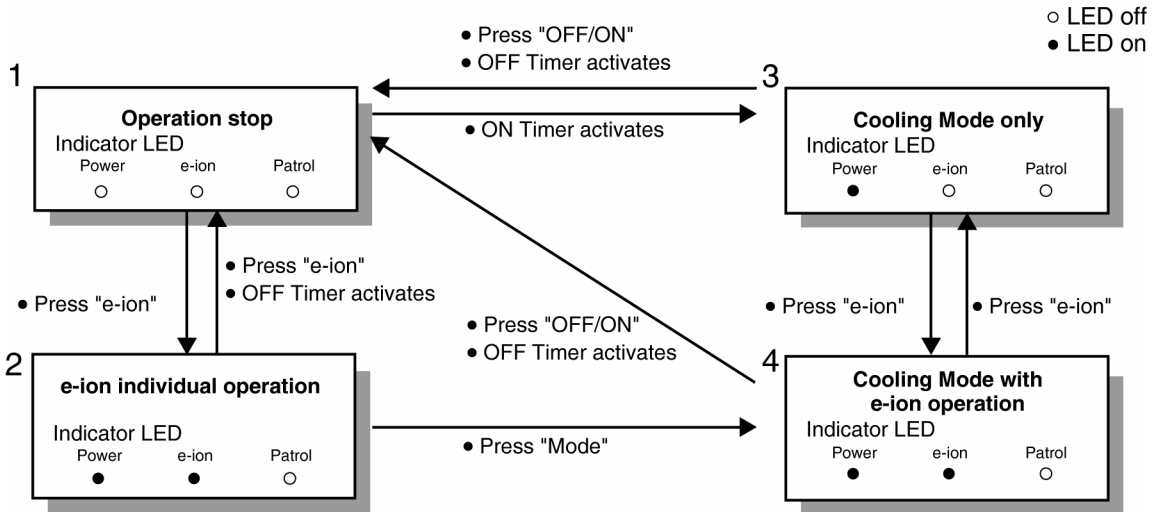

- Purpose
 - This operation provides clean air by producing negative ions to attract dust captured at the positively charged e-ion filters.
- Control condition
 - e-ion operation start condition
 - During unit running at any operation mode, if “e-ion” button is pressed, combination operation (operation mode + e-ion operation) starts.
 - During unit is OFF, if “e-ion” button is pressed, e-ion individual operation starts.
 - e-ion operation stop condition
 - When “OFF/ON” button is pressed to stop the operation.
 - When “e-ion” button is pressed again.
 - When “PATROL” button is pressed.
 - When OFF Timer activates.
 - e-ion operation pause condition
 - When indoor fan stop (during deice, odor cut control, thermostat off, etc.). e-ion operation resume after indoor fan restarts.
 - When indoor intake temperature $\geq 40^{\circ}\text{C}$. e-ion operation resume after indoor intake temperature $< 40^{\circ}\text{C}$ continuously for 30 minutes.
- Control Content
 - Indoor fan control
 - During any operation mode combines with e-ion operation, fan speed follows respective operation mode.
 - During e-ion individual operation - only Auto Fan Speed and no Powerful operation is allowed. Even if Fan Speed button is pressed, no signal is sent to air conditioner, and no change on LCD display.

Auto Fan Speed for e-ion operation switches between HLo and CLo at pattern below:

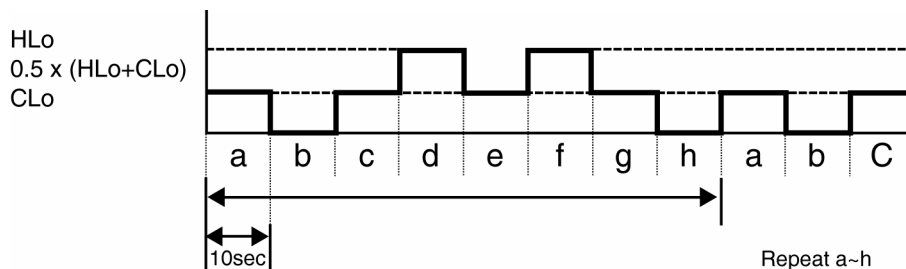

- Airflow direction control
 - During any operation mode combines with e-ion operation, airflow direction follows respective operation mode.
 - During e-ion individual operation, only Auto Air Swing is allowed. Even if Air Swing button is pressed, no signal is sent to air conditioner, and no change on LCD display.

- Timer control
 - When ON timer activates when unit stops, previous operation resumes and restores last saved e-ion operation status.
 - When ON timer activates during any operation, no change and carry on current operation.
 - When OFF timer activates during any operation, all operation stops and the latest e-ion operation status is saved.
- Indicator
 - When e-ion operation starts, e-ion indicator ON.
- e-ion Check Mode
 - To check if e-ion is malfunctioning, press “e-ion” button and follow by “Check” button to enter e-ion check mode and supplies power to the e-ion Air Purifying System.
 - If abnormal discharge is detected at filter (short-circuited) due to water or dust adhesion, etc., the e-ion indicator blinks immediately.
- Power failure
 - During e-ion individual operation, if power failure occurs, after power resumes, e-ion individual operation resumes immediately.
 - During combination operation, if power failure occurs, after power resumes, combination operation resume immediately.
- Error Detection Control

When e-ion indicator blink, it indicates error listed below:

 - e-ion Air Purifying system main connector to PCB is open:

Judgement Method

 - During e-ion operation (include during Patrol operation), e-ion Air Purifying system main connector to PCB is opened.

Troubleshooting Methods

 - Connect the connector or stop operation (include during Patrol operation) to cancel the blinking.
 - Abnormal Discharge

Judgement Method

 - During e-ion operation, when feedback voltage is -Lo (at microcontroller) is detected, it is judged abnormal discharge and stops power supplies to the e-ion Air Purifying system.
 - The unit retries after 30 minutes and repeat for 24 times. (not applicable for e-ion Check Mode)

Troubleshooting Method

 - Press “e-ion” button or “OFF/ON” button to stop the operation and check the e-ion Air Purifying system main connector to PCB.
 - After that, press “e-ion” button again to confirm the e-ion indicator not blinking.
 - The 24 times counter will be clear after 10 minutes of normal operation or when operation stops.

Error Reset Method

 - Press “OFF/ON” button to OFF the operation.
 - Press AUTO OFF/ON button at indoor unit to OFF the operation.
 - OFF Timer activates.
 - Press “e-ion” button during e-ion individual mode.
 - Power supply reset.
 - e-ion breakdown

Judgement Method

 - When hi-feedback voltage (at microcontroller) supplied to filter during e-ion stop, due to PCB or filter’s high voltage power supply damage.
 - Operations except e-ion continue. Both Timer indicator and e-ion indicator blink.

Troubleshooting Method

 - Press “e-ion” button or “OFF/ON” button to stop the operation.
 - Change main circuit board or filter’s high voltage power supply.
 - When lo-feedback voltage supplied to e-ion Air Purifying system during e-ion operation, e-ion indicator and Timer indicator stop blinking.

12.13 +8/10°C Operation

- +8/10°C Heat operation provides heating at low setting temperature in unoccupied houses during winter for the purpose of protecting equipments or housing appliances which may be destroyed by the extreme cold weather.
- This operation can be ON by pressing the +8/10°C heat button on the remote control.
- Two temperature settings are available, which are;
 - 8°C (Pressing TEMP down button at the remote control)
 - 10°C (Pressing TEMP up button at the remote control)
- During the operation of this mode;
 - The indoor fan speed will remain at Hi fan tap all the time included deice process.
 - Powerful operation, Quiet operation and Fan Speed selection are disabled.
 - Cold draft prevention control is disabled.
- Control condition;

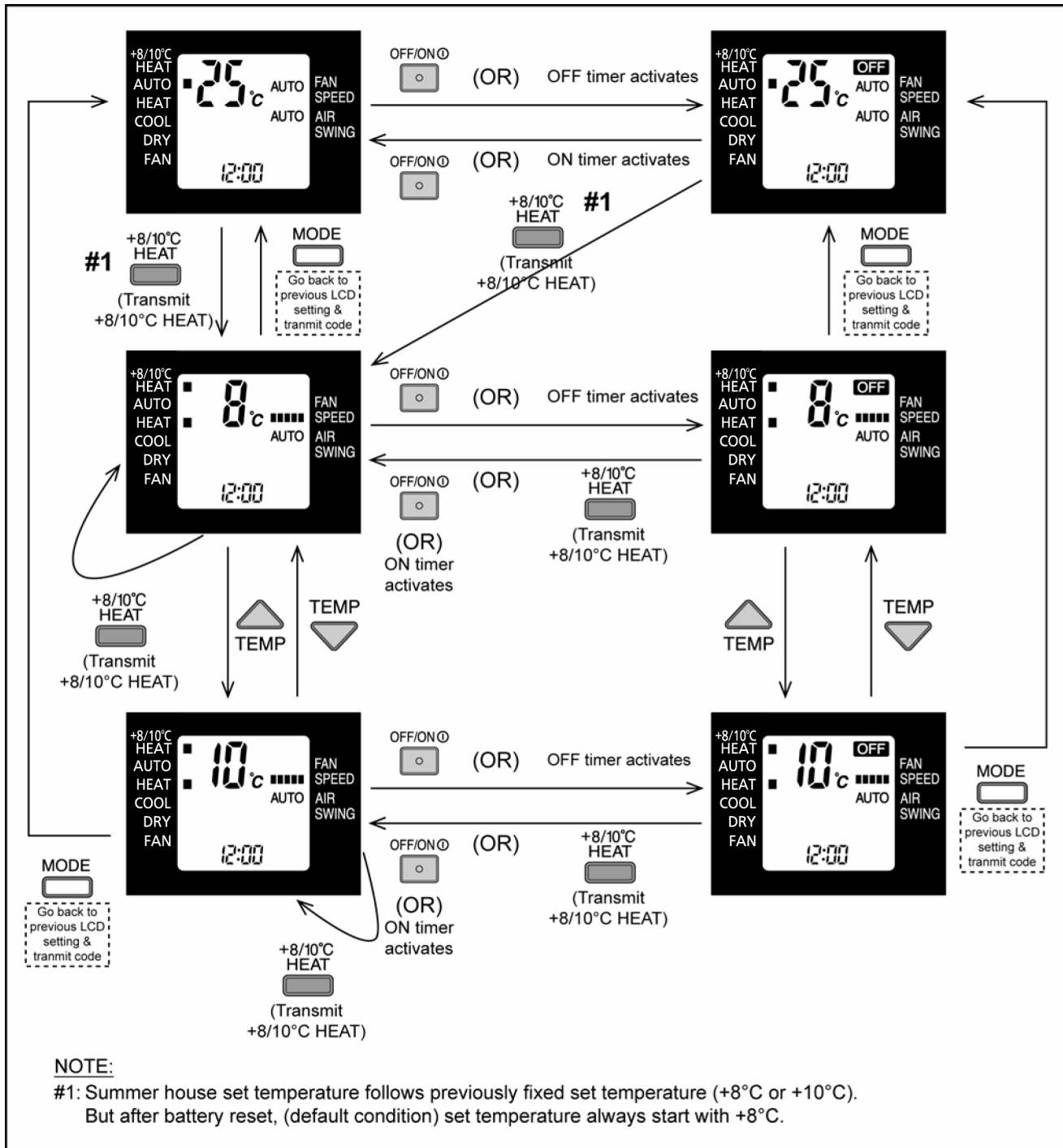

Caution!

If the indoor temperature constantly is less than 0°C (Door, windows not close properly), the error code F11 may occur. This is because in open area, the indoor sensor will misjudge operation condition and will give error code.

13. Protection Control

13.1 Protection Control For All Operations

13.1.1 Restart Control (Time Delay Safety Control)

- The Compressor will not turn on within 3 minutes from the moment operation stops, although the unit is turned on again by pressing OFF/ON button at remote control within this period.
- This control is not applicable if the power supply is cut off and on again.
- This phenomenon is to balance the pressure inside the refrigerant cycle.

13.1.2 30 Seconds Forced Operation

- Once the air conditioner is turned on, the compressor will not stop within 30 seconds in a normal operation although the intake air temperature has reached the thermo-off temperature. However, force stop by pressing the OFF/ON button at the remote control is permitted or the Auto OFF/ON button at indoor unit.
- The reason for the compressor to force operation for minimum 30 seconds is to allow the refrigerant oil run in a full cycle and return back to the outdoor unit.

13.1.3 Total Running Current

- When the outdoor unit total running current (AC) exceeds X value, the frequency instructed for compressor operation will be decreased.
- If the running current does not exceed X value for 5 seconds, the frequency instructed will be increased.
- However, if total outdoor unit running current exceeds Y value, compressor will be stopped immediately for 3 minutes.

Model	QE9MK		QE12MK	
Operation Mode	X (A)	Y (A)	X (A)	Y (A)
Cooling / Soft Dry (A)	4.95	14.98	5.76	14.98
Cooling / Soft Dry (B)	4.43	14.98	5.25	14.98
Cooling / Soft Dry (C)	4.95	14.98	5.76	14.98
Heating	5.76	14.98	7.84	14.98

- The first 30 minutes of cooling operation, (A) will be applied.

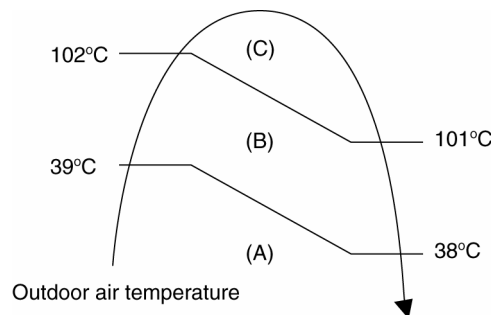

13.1.4 IPM (Power transistor) Prevention Control

- Overheating Prevention Control
 - When the IPM temperature rises to 100°C, compressor operation will stop immediately.
 - Compressor operation restarts after 3 minutes the temperature decreases to 95°C.
 - If this condition repeats continuously 4 times within 20 minutes, timer LED will be blinking (“F96” is indicated).
- DC Peak Current Control
 - When electric current to IPM exceeds set value of 20.2 A, the compressor will stop operate. Then, operation will restart after 3 minutes.
 - If the set value is exceeded again more than 30 seconds after the compressor starts, the operation will restart after 1 minute.
 - If the set value exceeded again within 30 seconds after the compressor starts, the operation will restart after 2 minutes. If this condition repeats continuously for 7 times, all indoor and outdoor relays will be cut off, timer LED will be blinking (“F99” is indicated).

13.1.5 Compressor Overheating Prevention Control

- Instructed frequency for compressor operation will be regulated by compressor discharge temperature. The changes of frequency are as below.
- If compressor discharge temperature exceeds 112°C, compressor will be stopped, occurs 4 times per 20 minutes, timer LED will be blinking. ("F97" is indicated.)

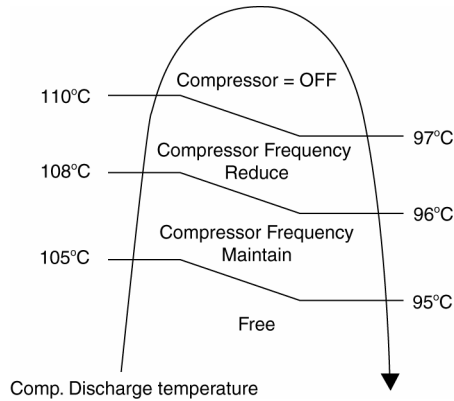

13.1.6 Low Pressure Prevention Control (Gas Leakage Detection)

- Control start conditions
 - For 5 minutes, the compressor continuously operates and outdoor total current is between 0.6A and 1.15A.
 - During Cooling and Soft Dry operations:
Indoor suction temperature - indoor piping temperature is below 4°C.
 - During Heating operations :
Indoor piping temperature - indoor suction is under 5°C.
- Control contents
 - Compressor stops (and restart after 3 minutes).
 - If the conditions above happen 2 times within 20 minutes, the unit will:
 - Stop operation
 - Timer LED blinks and "F91" indicated.

13.1.7 Low Frequency Protection Control 1

- When the compressor operate at frequency lower than 25 Hz continued for 240 minutes, the operation frequency will be changed to 24 Hz for 2 minutes.

13.1.8 Low Frequency Protection Control 2

- When all the below conditions comply, the compressor frequency will change to lower frequency.

Temperature, T, for:	Cooling/Soft Dry	Heating
Indoor intake air (°C)	T < 14 or T ≥ 30	T < 14 or T ≥ 28
Outdoor air (°C)	T < 13 or T ≥ 38	T < 4 or T ≥ 24
Indoor heat exchanger (°C)	T < 30	T ≥ 0

13.2 Protection Control For Cooling & Soft Dry Operation

13.2.1 Outdoor Air Temperature Control

- The compressor operating frequency is regulated in accordance to the outdoor air temperature as shown in the diagram below.
- This control will begin 1 minute after the compressor starts.
- Compressor frequency will adjust base on outdoor air temperature.

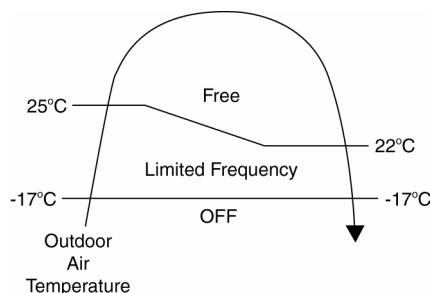

13.2.2 Cooling Overload Control

- Detects the outdoor pipe temperature and carry out below restriction/limitation (Limit the compressor Operation frequency)
- The compressor stops if outdoor pipe temperature exceeds 63°C.
- If the compressor stops 4 times in 20 minutes, Timer LED blinks (F95 indicated: outdoor high pressure rise protection)

13.2.3 Freeze Prevention Control 1

- When indoor heat exchanger temperature is lower than 0°C continuously for 6 minutes, compressor will stop operating.
- Compressor will resume its operation 3 minutes after the indoor heat exchanger is higher than 5°C.
- At the same time, indoor fan speed will be higher than during its normal operation.
- If the indoor heat exchanger temperature is higher than 5°C for 5 minutes, the fan speed will return to its normal operation.

13.2.4 Freeze Prevention Control 2

- Control start conditions
 - During Cooling operation and soft dry operation
 - During thermo OFF condition, indoor intake temperature is less than 10°C or
 - Compressor stops for freeze prevention control
 - Either one of the conditions above occurs 5 times in 60 minutes.
- Control contents
 - Operation stops
 - Timer LED blinks and "H99" indicated

13.2.5 Dew Prevention Control 1

- To prevent dew formation at indoor unit discharge area.
- This control will be activated if:
 - Outdoor air temperature and Indoor pipe temperature judgment by microcontroller is fulfilled.
 - When Cooling or Dry mode is operated more than 20 minutes or more.
- This control stopped if:
 - Compressor stopped.
 - Remote control setting changed (fan speed / temperature).
 - Outdoor air temperature and indoor intake temperature changed.
- Fan speed, angle of louver (vertical airflow angle) will be adjusted accordingly in this control.
 - Fan speed will be increased slowly if the unit is in quiet mode but no change in normal cooling mode.

13.2.6 Dew Prevention Control 2

- To prevent dew formation at indoor unit discharge area.
- This control starts if all conditions continue for 20 minutes:
 - Operated with Cooling or Soft Dry Mode.
 - Indoor intake temperature is between 25°C and 29°C.
 - Outdoor air temperature is less than 30°C.
 - Quiet Lo fan speed.
- This control stopped if:
 - When receive air swing change signal from Remote Control.
- The horizontal louver will be fixed at 26° (regardless of Auto or Manual Airflow Direction Setting).

13.3 Protection Control For Heating Operation

13.3.1 Intake Air Temperature Control

Compressor will operate at limited freq., if indoor intake air temperature is 30°C or above.

13.3.2 Outdoor Air Temperature Control

- The Max current value is regulated when the outdoor air temperature rise above 14°C in order to avoid compressor overloading.

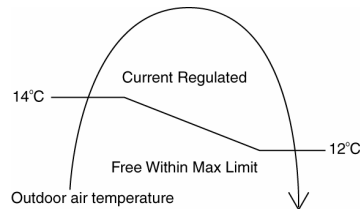

13.3.3 Overload Protection Control

- The compressor operating frequency is regulated in accordance to indoor heat exchanger temperature as shown below.
- If the heat exchanger temperature exceeds 60°C, compressor will stop.

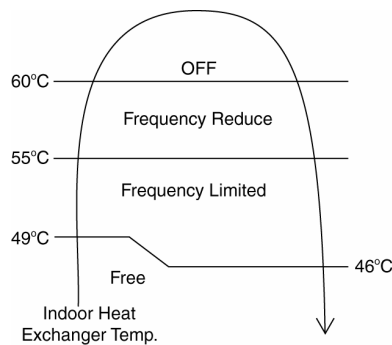

13.3.4 Low Temperature Compressor Oil Return Control

- In heating operation, if the outdoor temperature falls below -10°C when compressor starts, the compressor frequency will be regulated up to 600 seconds.

13.3.5 Cold Draught Prevention Control

- When indoor pipe temperature is low, cold draught operation starts where indoor fan speed will be reduced.

13.3.6 Deice Operation

- When outdoor pipe temperature and outdoor air temperature is low, deice operation start where indoor fan motor and outdoor fan motor stop and operation LED blinks.

14. Servicing Mode

14.1 Auto OFF/ON Button

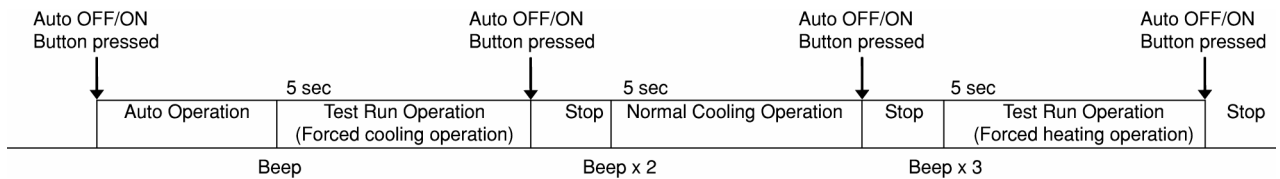

1 AUTO OPERATION MODE

The Auto Operation will be activated immediately once the Auto OFF/ON button is pressed. This operation can be used to operate air conditioner with limited function if remote control is misplaced or malfunction.

2 TEST RUN OPERATION (FOR PUMP DOWN/SERVICING PURPOSE)

The Test Run operation will be activated if the Auto OFF/ON button is pressed continuously for more than 5 seconds. A “beep” sound will heard at the fifth seconds, in order to identify the starting of Test Run operation (Forced cooling operation). Within 5 minutes after Forced cooling operation start, the Auto OFF/ON button is pressed for more than 5 seconds. A 2 “beep” sounds will heard at the fifth seconds, in order to identify the starting of Forced heating operation.

The Auto OFF/ON button may be used together with remote control to set / change the advance setting of air conditioner operation.

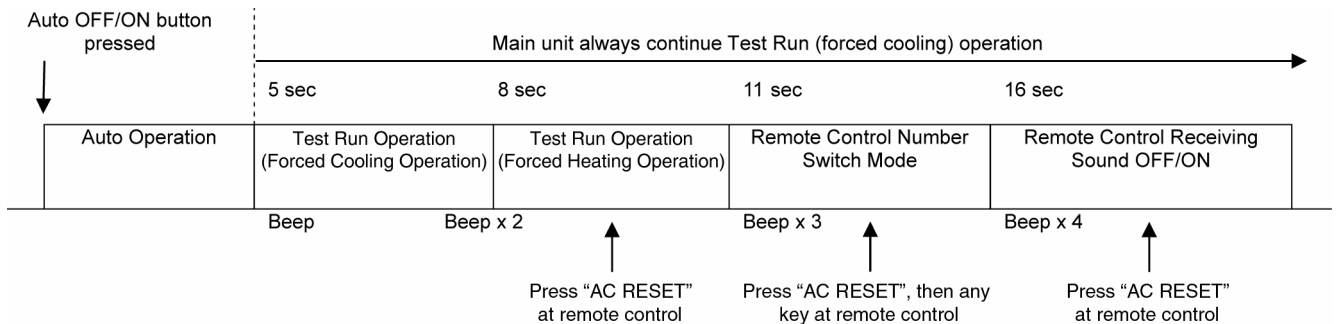

3 REMOTE CONTROL NUMBER SWITCH MODE

The Remote Control Number Switch Mode will be activated if the Auto OFF/ON button is pressed continuously for more than 11 seconds (3 “beep” sounds will occur at 11th seconds to identify the Remote Control Number Switch Mode is in standby condition) and press “AC RESET” button and then press any button at remote control to transmit and store the desired transmission code to the EEPROM.

There are 4 types of remote control transmission code could be selected and stored in EEPROM of indoor unit. The indoor unit will only operate when received signal with same transmission code from remote control. This could prevent signal interference when there are 2 or more indoor units installed nearby together. To change remote control transmission code, short or open jumpers at the remote control printed circuit board.

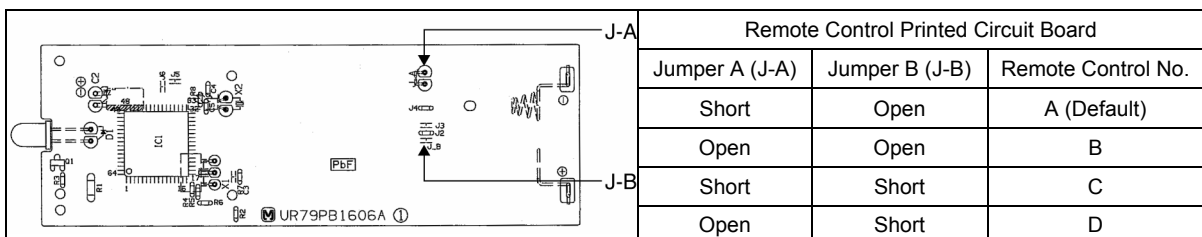

- During Remote Control Number Switch Mode, press any button at remote control to transmit and store the transmission code to the EEPROM.

4 REMOTE CONTROL RECEIVING SOUND OFF/ON MODE

The Remote Control Receiving Sound OFF/ON Mode will be activated if the Auto OFF/ON button is pressed continuously for more than 16 seconds (4 “beep” sounds will occur at 16th seconds to identify the Remote Control Receiving Sound Off/On Mode is in standby condition) and press “AC Reset” button at remote control.

Press “Auto OFF/ON button” to toggle remote control receiving sound.

- Short “beep”: Turn OFF remote control receiving sound.
- Long “beep”: Turn ON remote control receiving sound.

After Auto OFF/ON Button is pressed, the 20 seconds counter for Remote Control Receiving Sound OFF/ON Mode is restarted.

14.2 Remote Control Button

14.2.1 SET Button

- To check remote control transmission code and store the transmission code to EEPROM:
 - Press “Set” button for more than 10 seconds by using pointer.
 - Press “Timer Set” button until a “beep” sound is heard as confirmation of transmission code changed.
- To change the air quality sensor sensitivity:
 - Press and release by using pointer.
 - Press the Timer Decrement button to select sensitivity:
 1. Low sensitivity
 2. Standard (Default)
 3. Hi sensitivity
 - Confirm setting by pressing Timer Set button, a “Beep” sound will be heard. LCD returns to original display after 2 seconds.
 - LCD returns to original display if remote control does not operate for 30 seconds.

14.2.2 CLOCK BUTTON

- To change the remote control’s time format
 - Press for more than 5 seconds

14.2.3 RESET (RC)

- To clear and restore the remote control setting to factory default.
 - Press once to clear the memory

14.2.4 RESET (AC)

- To restore the unit’s setting to factory default
 - Press once to restore the unit’s setting.

14.2.5 TIMER ▲

- To change indoor unit indicators’ intensity:
 - Press continuously for 5 seconds.

14.2.6 TIMER ▼

- To change remote control display from Degree Celsius (°C) to Degree Fahrenheit (°F)
 - Press continuously for 10 seconds.

15. Troubleshooting Guide

15.1 Refrigeration cycle system

In order to diagnose malfunctions, make sure that there are no electrical problems before inspecting the refrigeration cycle. Such problems include insufficient insulation, problem with the power source, malfunction of a compressor and a fan. The normal outlet air temperature and pressure of the refrigeration cycle depends on various conditions, the standard values for them are shown in the table on the right.

Normal Pressure and Outlet Air Temperature (Standard)

	Gas Pressure Mpa (kg/cm ² G)	Outlet air Temperature (°C)
Cooling Mode	0.9 ~ 1.2 (9 ~ 12)	12 ~ 16
Heating Mode	2.3 ~ 2.9 (23 ~ 29)	36 ~ 45

- *Condition:
- Indoor fan speed = High
 - Outdoor temperature 35°C at the cooling mode and 7°C at the heating mode
 - Compressor operates at rated frequency

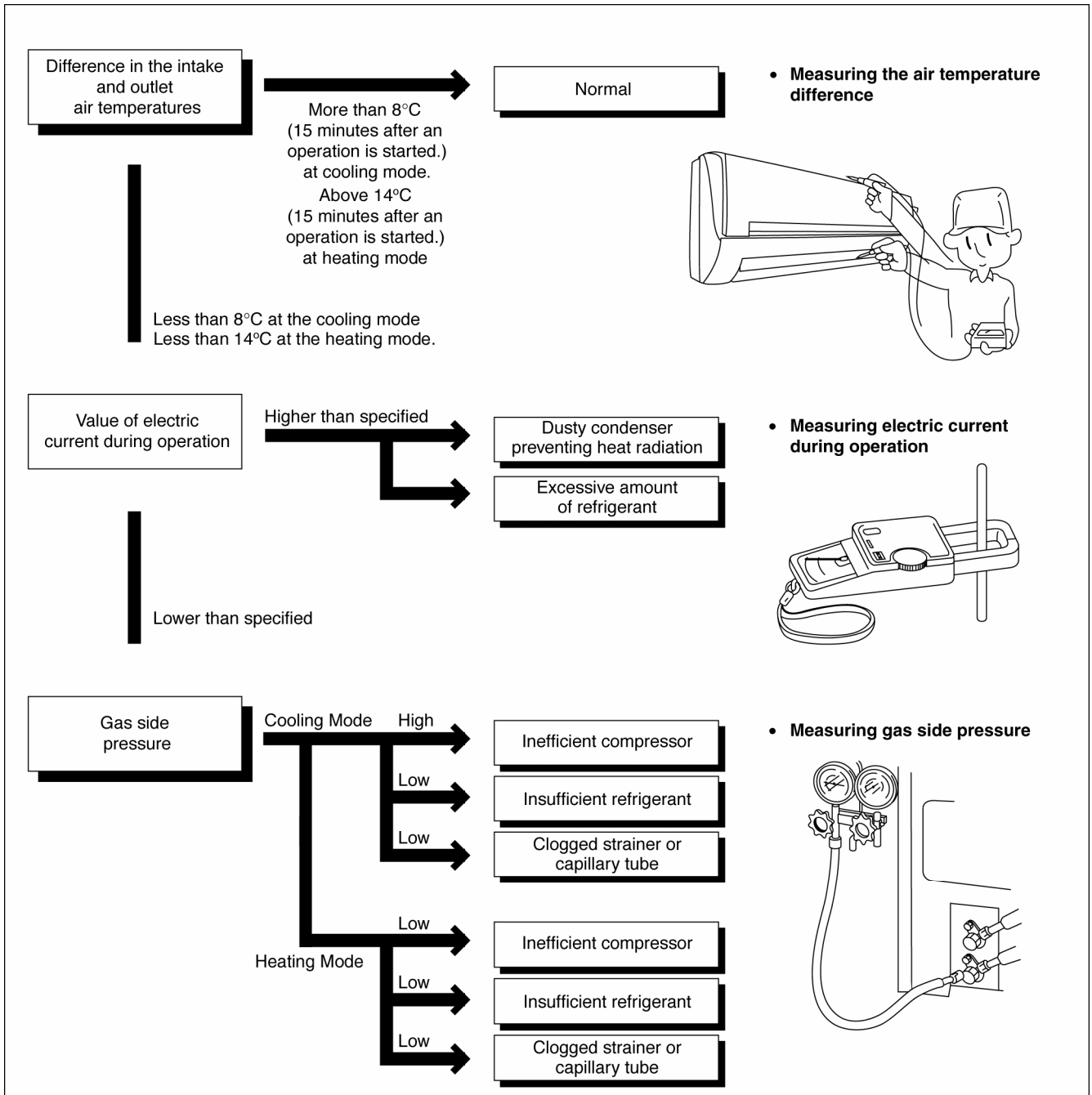

15.1.1 Relationship between the condition of the air conditioner and pressure and electric current

Condition of the air conditioner	Cooling Mode			Heating Mode		
	Low Pressure	High Pressure	Electric current during operation	Low Pressure	High Pressure	Electric current during operation
Insufficient refrigerant (gas leakage)	↘	↘	↘	↘	↘	↘
Clogged capillary tube or strainer	↘	↘	↘	↗	↗	↗
Short circuit in the indoor unit	↘	↘	↘	↗	↗	↗
Heat radiation deficiency of the outdoor unit	↗	↗	↗	↘	↘	↘
Inefficient compression	↗	↘	↘	↗	↘	↘

- Carry out the measurement of pressure, electric current, and temperature fifteen minutes after an operation is started.

15.2 Breakdown Self Diagnosis Function

15.2.1 Self Diagnosis Function (Three Digits Alphanumeric Code)

- Once abnormality has occurred during operation, the unit will stop its operation, and Timer LED blinks.
 - Although Timer LED goes off when power supply is turned off, if the unit is operated under a breakdown condition, the LED will light up again.
 - In operation after breakdown repair, the Timer LED will no more blink. The last error code (abnormality) will be stored in IC memory.
- 5 Every press of the button (up or down) will increase abnormality numbers and transmit abnormality code signal to the main unit.
 - 6 When the latest abnormality code on the main unit and code transmitted from the remote controller are matched, power LED will light up for 30 seconds and a beep sound (continuously for 4 seconds) will be heard. If no codes are matched, power LED will light up for 0.5 seconds and no sound will be heard.

15.2.2 To Make a Diagnosis

- 1 Timer LED start to blink and the unit automatically stops the operation.
- 2 Press the CHECK button on the remote controller continuously for 5 seconds.
- 3 “- -” will be displayed on the remote controller display.
Note: Display only for “- -”. (No transmitting signal, no receiving sound and no Power LED blinking.)
- 4 Press the “TIMER” ▲ or ▼ button on the remote controller. The code “H00” (no abnormality) will be displayed and signal will be transmitted to the main unit.
- 5 Every press of the button (up or down) will increase abnormality numbers and transmit abnormality code signal to the main unit.
- 6 When the latest abnormality code on the main unit and code transmitted from the remote controller are matched, power LED will light up for 30 seconds and a beep sound (continuously for 4 seconds) will be heard. If no codes are matched, power LED will light up for 0.5 seconds and no sound will be heard.
- 7 The breakdown diagnosis mode will be canceled unless pressing the CHECK button continuously for 5 seconds or operating the unit for 30 seconds.
- 8 The LED will be off if the unit is turned off or the RESET button on the main unit is pressed.

15.2.3 To Display Memorized Error Code (Protective Operation) Status

- 1 Turn power on.
- 2 Press the CHECK button on the remote controller continuously for 5 seconds.
- 3 “- -” will be displayed on the remote controller display.
Note: Display only for “- -”. (No transmitting signal, no receiving sound and no Power LED blinking.)
- 4 Press the “TIMER” ▲ or ▼ button on the remote controller. The code “H00” (no abnormality) will be displayed and signal will be transmitted to the main unit. The power LED lights up. If no abnormality is stored in the memory, three beeps sound will be heard.

- 7 The breakdown diagnosis mode will be canceled unless pressing the CHECK button continuously for 5 seconds or operating the unit for 30 seconds.
- 8 The same diagnosis can be repeated by turning power on again.

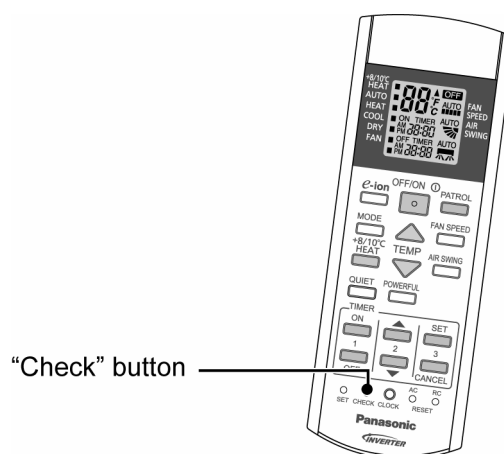

15.2.4 To Clear Memorized Error Code after Repair (Protective Operation)

- 1 Turn power on (in standby condition).
- 2 Press the AUTO button for 5 seconds (A beep receiving sound) on the main unit to operate the unit at Forced Cooling Operation modes.
- 3 Press the CHECK button on the remote controller for about 1 second with a pointed object to transmit signal to main unit. A beep sound is heard from main unit and the data is cleared.

15.2.5 Temporary Operation (Depending On Breakdown Status)

- 1 Press the AUTO button (A beep receiving sound) on the main unit to operate the unit. (Remote control will become possible.)
- 2 The unit can temporarily be used until repaired.

15.3 Error Code Table

Diagnosis display	Abnormality / Protection control	Abnormality Judgement	Protection operation	Problem	Check location
H00	No memory of failure	—	Normal operation	—	—
H11	Indoor/outdoor abnormal communication	After operation for 1 minute	Indoor fan only operation can start by entering into force cooling operation	Indoor/outdoor communication not establish	<ul style="list-style-type: none"> Indoor/outdoor wire terminal Indoor/outdoor PCB Indoor/outdoor connection wire
H14	Indoor intake air temperature sensor abnormality	Continuous for 5s	—	Indoor intake air temperature sensor open or short circuit	Indoor intake air temperature sensor lead wire and connector
H15	Compressor temperature sensor abnormality	Continuous for 5s	—	Compressor temperature sensor open or short circuit	Compressor temperature sensor lead wire and connector
H16	Outdoor current transformer (CT) abnormality	—	—	Current transformer faulty or compressor faulty	Outdoor PCB faulty or compressor faulty
H19	Indoor fan motor mechanism lock	Continuous happen for 7 times	—	Indoor fan motor lock or feedback abnormal	<ul style="list-style-type: none"> Fan motor lead wire and connector Fan motor lock or block
H23	Indoor heat exchanger temperature sensor 1 abnormality	Continuous for 5s	—	Indoor heat exchanger temperature sensor 1 open or short circuit	Indoor heat exchanger temperature sensor 1 lead wire and connector
H24	Indoor heat exchanger temperature sensor 2 abnormality	Continuous for 5s	—	Indoor heat exchanger temperature sensor 2 open or short circuit	Indoor heat exchanger temperature sensor 2 lead wire and connector
H25	Indoor E-Ion abnormality	Port is ON for 10s during E-Ion off	—	—	E-Ion PCB
H27	Outdoor air temperature sensor abnormality	Continuous for 5s	—	Outdoor air temperature sensor open or short circuit	Outdoor air temperature sensor lead wire and connector
H28	Outdoor heat exchanger temperature sensor 1 abnormality	Continuous for 5s	—	Outdoor heat exchanger temperature sensor 1 open or short circuit	Outdoor heat exchanger temperature sensor 1 lead wire and connector
H30	Outdoor discharge pipe temperature sensor abnormality	Continuous for 5s	—	Outdoor discharge pipe temperature sensor open or short circuit	Outdoor discharge pipe temperature sensor lead wire and connector
H33	Indoor / outdoor misconnection abnormality	—	—	Indoor and outdoor rated voltage different	Indoor and outdoor units check
H38	Indoor/Outdoor mismatch (brand code)	—	—	Brand code not match	Check indoor unit and outdoor unit.
H58	Indoor gas sensor abnormality	Continuous for 6 hours	—	Indoor gas sensor open or short circuit	<ul style="list-style-type: none"> Indoor gas sensor Indoor PCB
H97	Outdoor fan motor mechanism lock	2 times happen within 30 minutes	—	Outdoor fan motor lock or feedback abnormal	<ul style="list-style-type: none"> Outdoor fan motor lead wire and connector Fan motor lock or block
H98	Indoor high pressure protection	—	—	Indoor high pressure protection (Heating)	<ul style="list-style-type: none"> Check indoor heat exchanger Air filter dirty Air circulation short circuit
H99	Indoor operating unit freeze protection	—	—	Indoor freeze protection (Cooling)	<ul style="list-style-type: none"> Check indoor heat exchanger Air filter dirty Air circulation short circuit
F11	4-way valve switching abnormality	4 times happen within 30 minutes	—	4-way valve switching abnormal	<ul style="list-style-type: none"> 4-way valve Lead wire and connector.
F90	Power factor correction (PFC) circuit protection	4 times happen within 10 minutes	—	Power factor correction circuit abnormal	Outdoor PCB faulty
F91	Refrigeration cycle abnormality	2 times happen within 20 minutes	—	Refrigeration cycle abnormal	Insufficient refrigerant or valve close

Diagnosis display	Abnormality / Protection control	Abnormality Judgement	Protection operation	Problem	Check location
F93	Compressor abnormal revolution	4 times happen within 20 minutes	—	Compressor abnormal revolution	• Power transistor module faulty or compressor lock
F95	Outdoor cooling high pressure protection	4 times happen within 20 minutes	—	Cooling high pressure protection	• Check refrigeration system • Outdoor air circuit
F96	Power transistor module overheating protection	4 times happen within 30 minutes	—	Power transistor module overheat	• PCB faulty • Outdoor air circuit (fan motor)
F97	Compressor overheating protection	3 times happen within 30 minutes	—	Compressor overheat	• Insufficient refrigerant
F98	Total running current protection	3 times happen within 20 minutes	—	Total current protection	• Check refrigeration system • Power source or compressor lock
F99	Outdoor direct current (DC) peak detection	Continuous happen for 7 times	—	Power transistor module current protection	• Power transistor module faulty or compressor lock

15.4 Self-diagnosis Method

15.4.1 H11 (Indoor/Outdoor Abnormal Communication)

Malfunction Decision Conditions

- During startup and operation of cooling and heating, the data received from outdoor unit in indoor unit signal transmission is checked whether it is normal.

Malfunction Caused

- Faulty indoor unit PCB.
- Faulty outdoor unit PCB.
- Indoor unit-outdoor unit signal transmission error due to wrong wiring.
- Indoor unit-outdoor unit signal transmission error due to breaking of wire in the connection wires between the indoor and outdoor units.
- Indoor unit-outdoor unit signal transmission error due to disturbed power supply waveform.

Troubleshooting

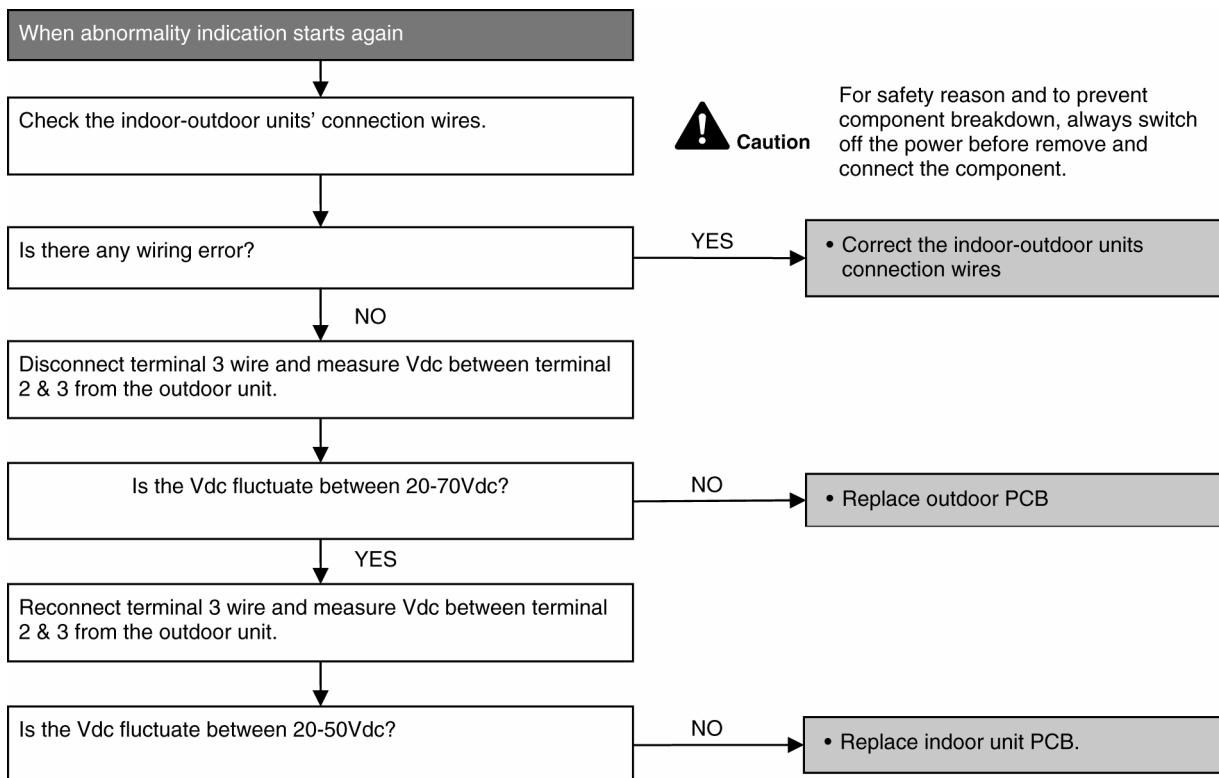

15.4.2 H14 (Indoor Intake Air Temperature Sensor Abnormality)

Malfunction Decision Conditions

- During startup and operation of cooling and heating, the temperatures detected by the indoor intake air temperature sensor are used to determine sensor errors.

Malfunction Caused

- Faulty connector connection.
- Faulty sensor.
- Faulty PCB.

Troubleshooting

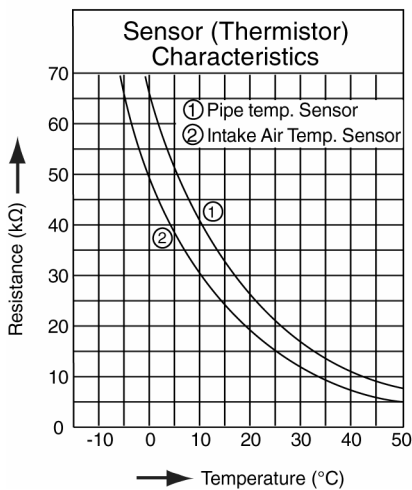
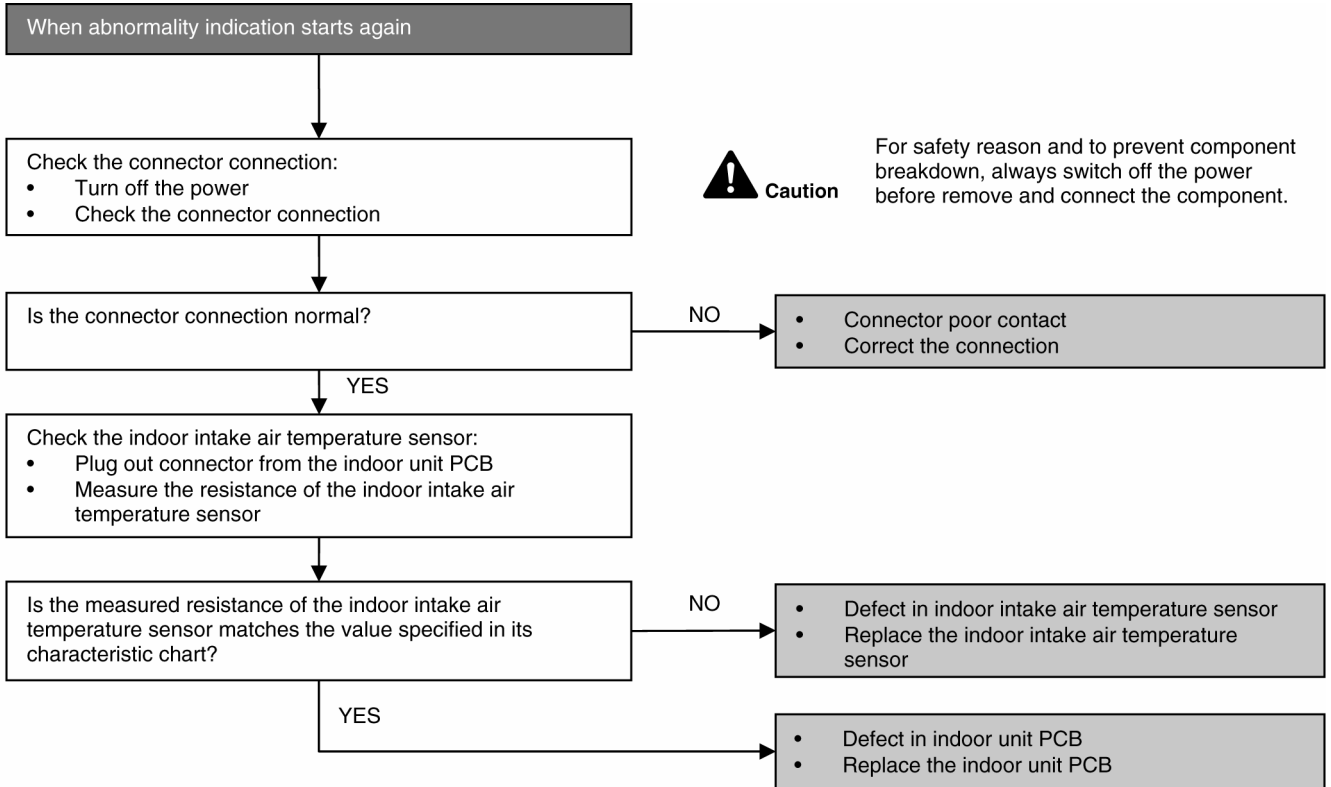

15.4.3 H15 (Compressor Temperature Sensor Abnormality)

Malfunction Decision Conditions

- During startup and operation of cooling and heating, the temperatures detected by the outdoor compressor temperature sensor are used to determine sensor errors.

Malfunction Caused

- Faulty connector connection.
- Faulty sensor.
- Faulty PCB.

Troubleshooting

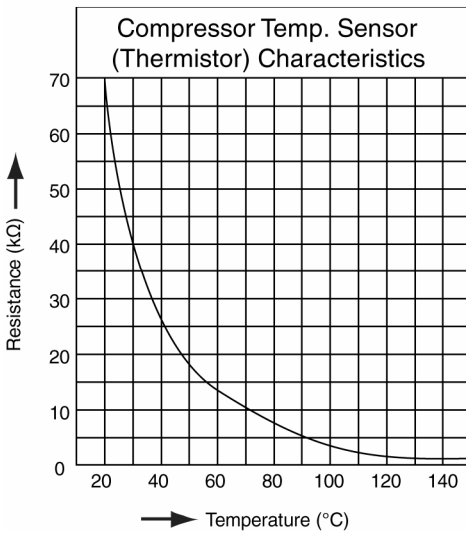
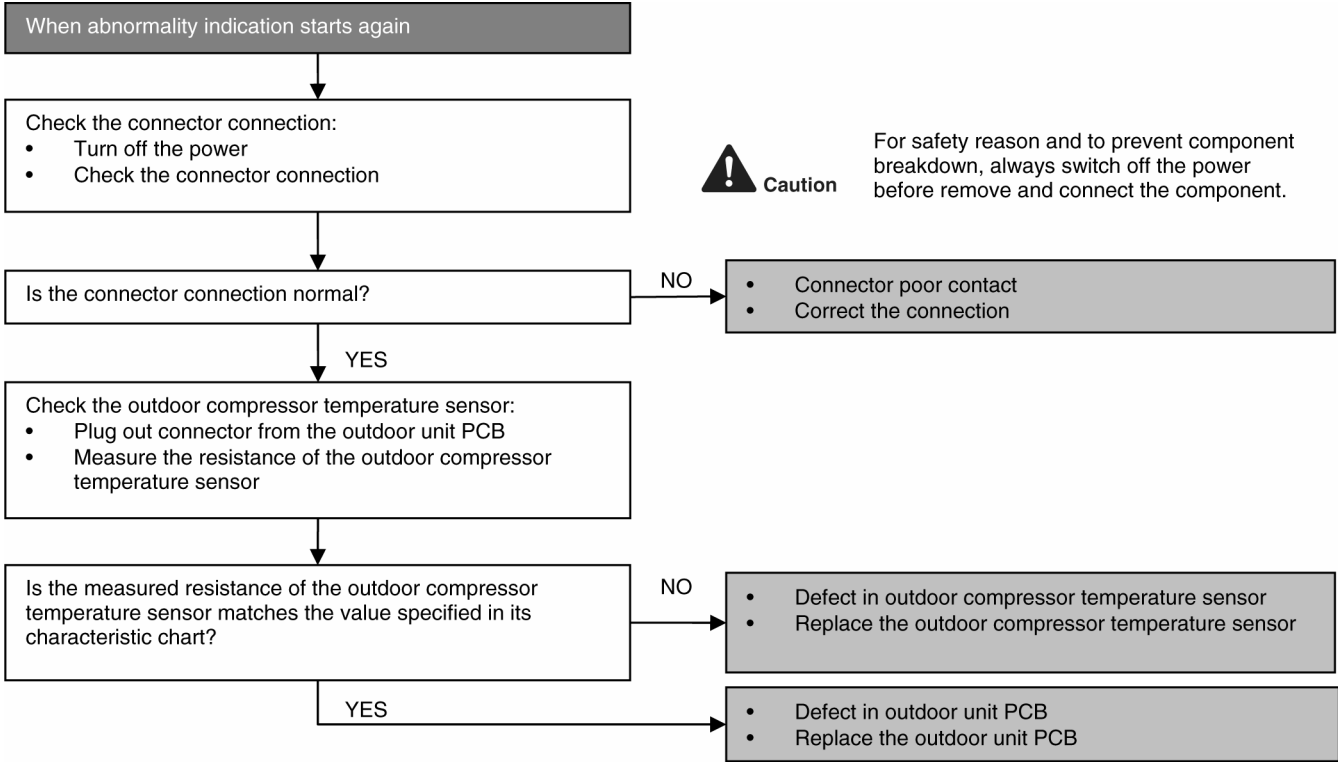

15.4.4 H16 (Outdoor Current Transformer Open Circuit)

Malfunction Decision Conditions

- A current transformer (CT) is detected by checking the compressor running frequency (\geq rated frequency) and CT detected input current (less than 0.65A) for continuously 20 seconds.

Malfunction Caused

- CT defective
- Outdoor PCB defective
- Compressor defective (low compression)

Troubleshooting

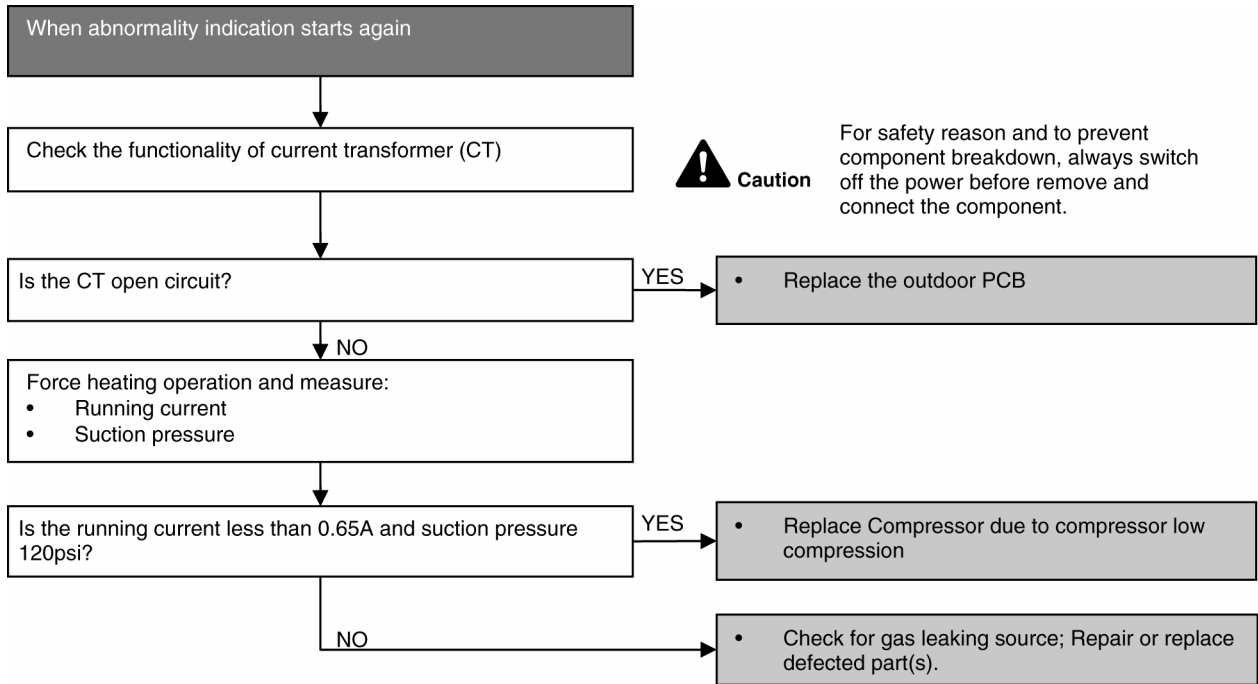

15.4.5 H19 (Indoor Fan Motor – DC Motor Mechanism Locked)

Malfunction Decision Conditions

- The rotation speed detected by the Hall IC during fan motor operation is used to determine abnormal fan motor (feedback of rotation > 2550rpm or < 50rpm)

Malfunction Caused

- Operation stops due to short circuit inside the fan motor winding.
- Operation stops due to breaking of wire inside the fan motor.
- Operation stops due to breaking of fan motor lead wires.
- Operation stops due to Hall IC malfunction.
- Operation error due to faulty indoor unit PCB.

Troubleshooting

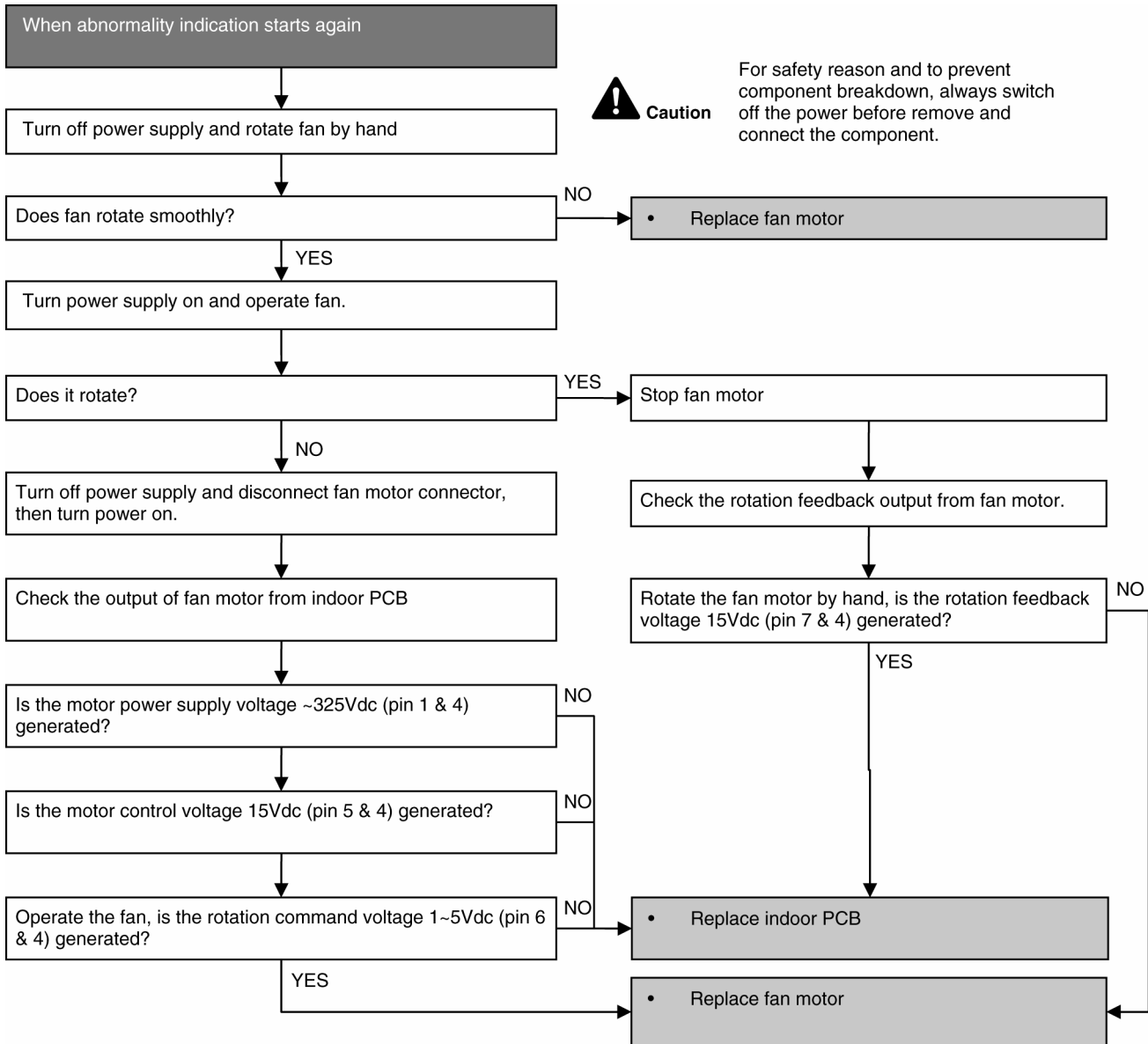

15.4.6 H23 (Indoor Pipe Temperature Sensor Abnormality)

Malfunction Decision Conditions

- During startup and operation of cooling and heating, the temperatures detected by the indoor heat exchanger temperature sensor 1 are used to determine sensor errors.

Malfunction Caused

- Faulty connector connection.
- Faulty sensor.
- Faulty PCB.

Troubleshooting

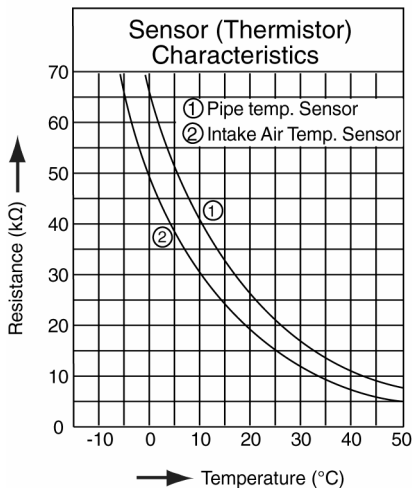
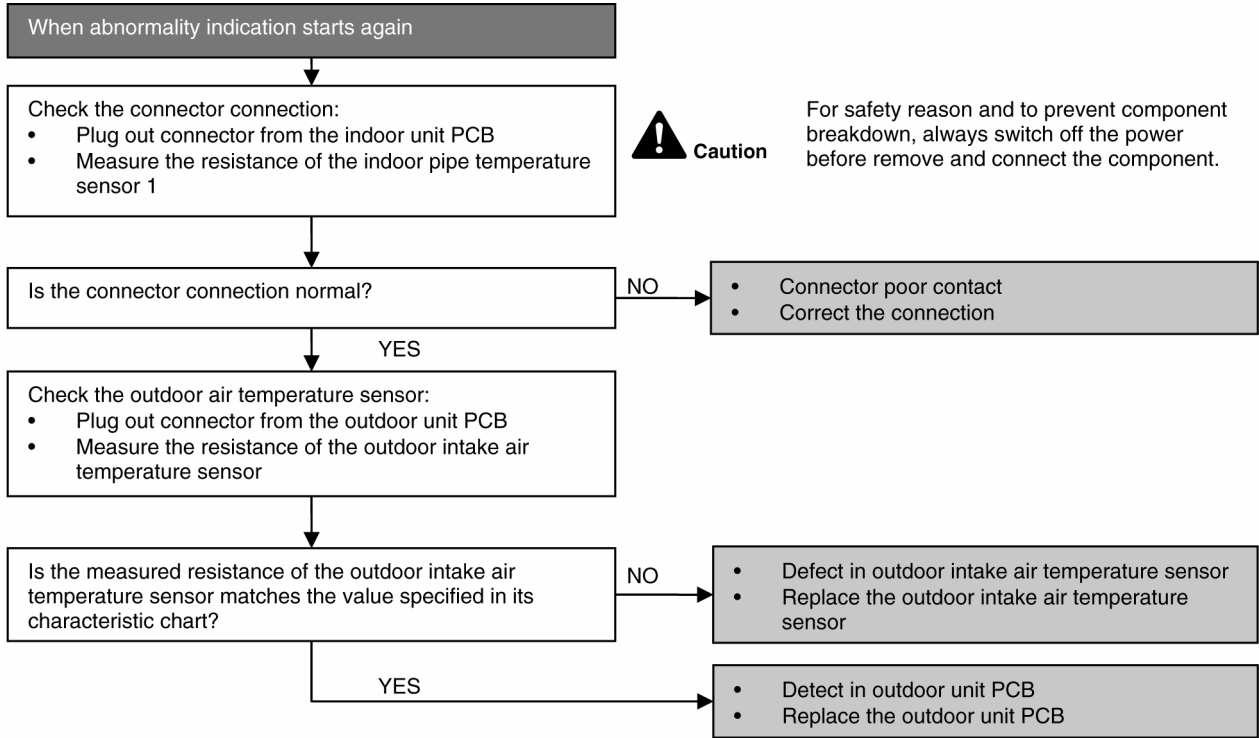

15.4.7 H24 (Indoor Pipe Temperature Sensor 2 Abnormality)

Malfunction Decision Conditions

- During startup and operation of cooling and heating, the temperatures detected by the indoor heat exchanger temperature sensor 2 are used to determine sensor errors.

Malfunction Caused

- Faulty connector connection.
- Faulty sensor.
- Faulty PCB.

Troubleshooting

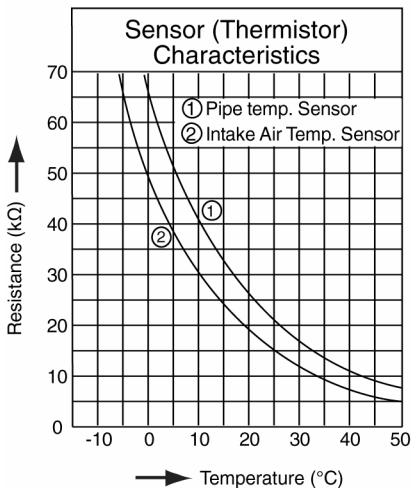
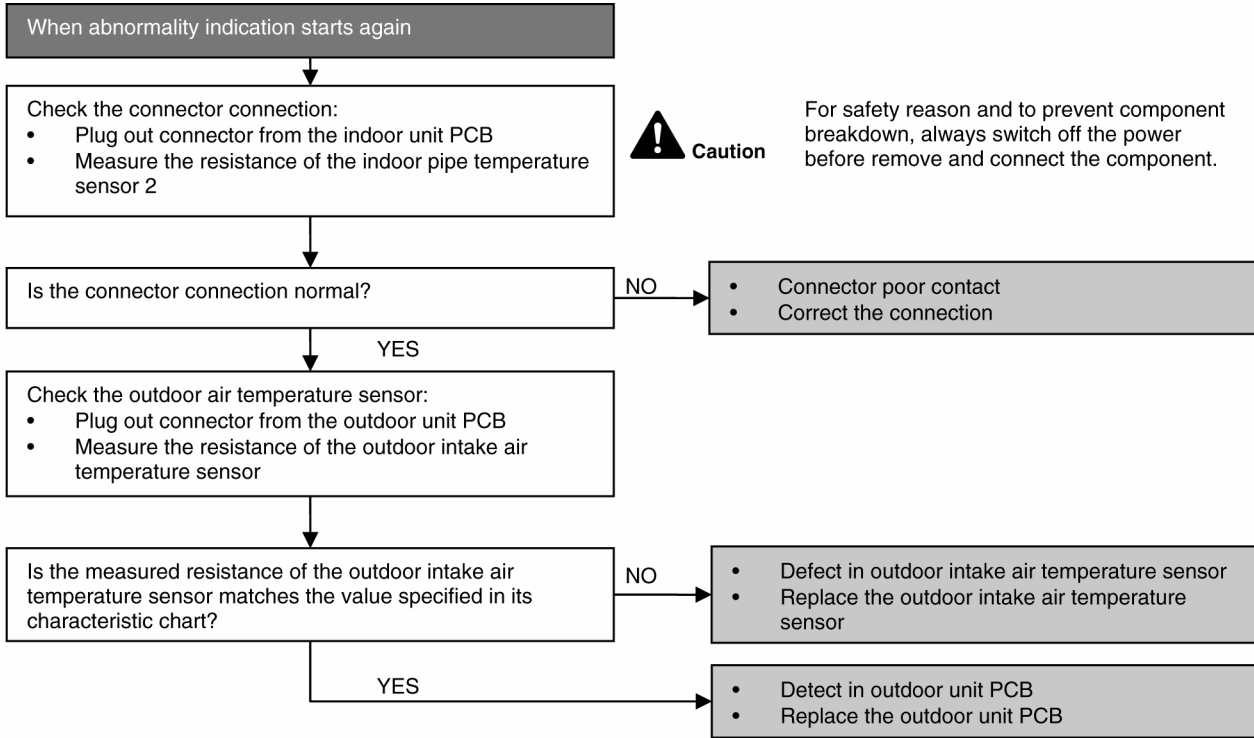

15.4.8 H25 (e-ion Air Purifying System Abnormal)

Malfunction Decision Conditions

- During standby of cooling and heating operation, e-ion breakdown occurs and air conditioner stops operation.

Malfunction Caused

- Faulty indoor main PCB.
- Faulty indoor e-ion power module.

Troubleshooting

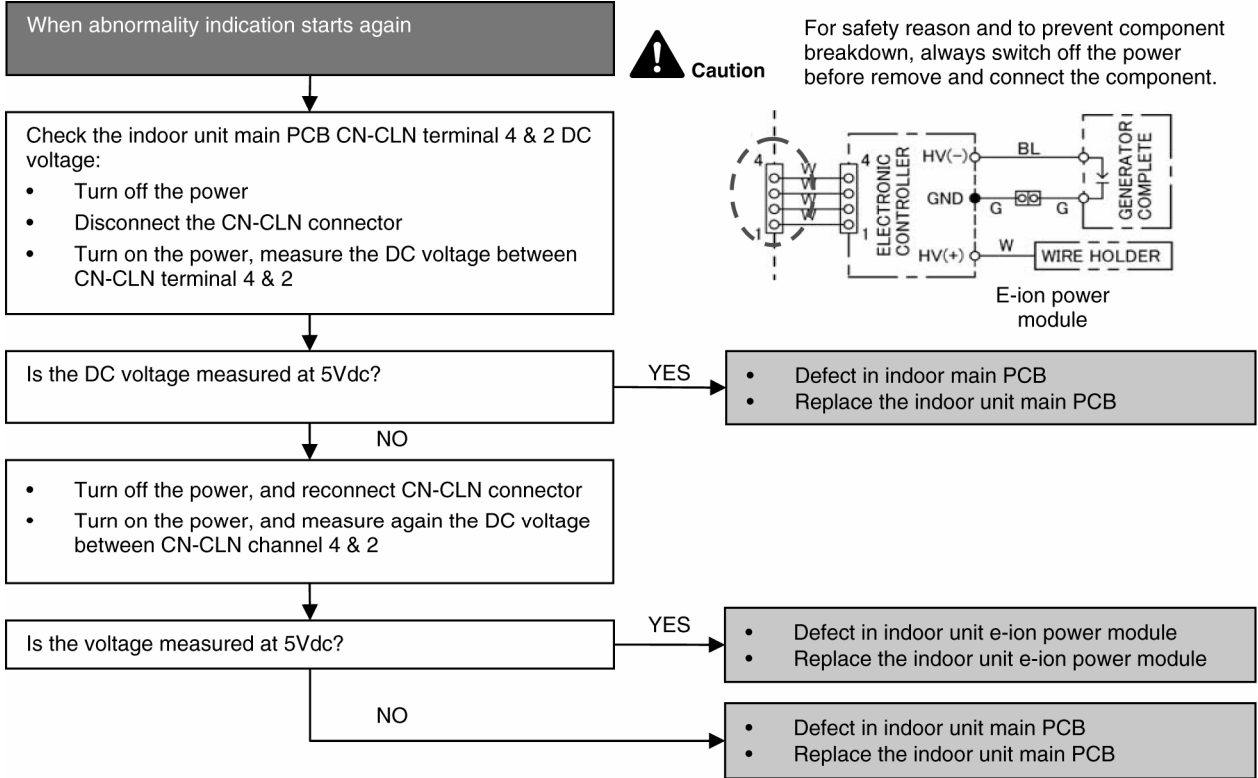

15.4.9 H27 (Outdoor Air Temperature Sensor Abnormality)

Malfunction Decision Conditions

- During startup and operation of cooling and heating, the temperatures detected by the outdoor air temperature sensor are used to determine sensor errors.

Malfunction Caused

- Faulty connector connection.
- Faulty sensor.
- Faulty PCB.

Troubleshooting

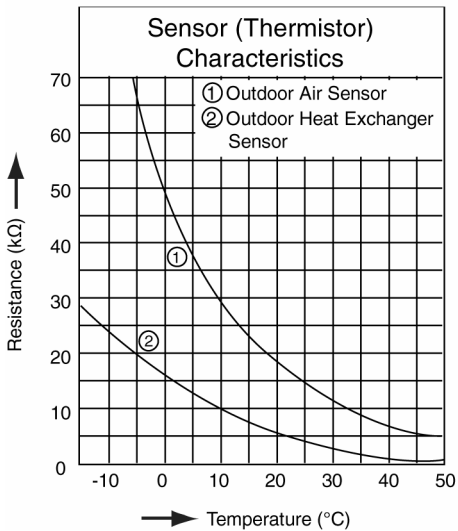
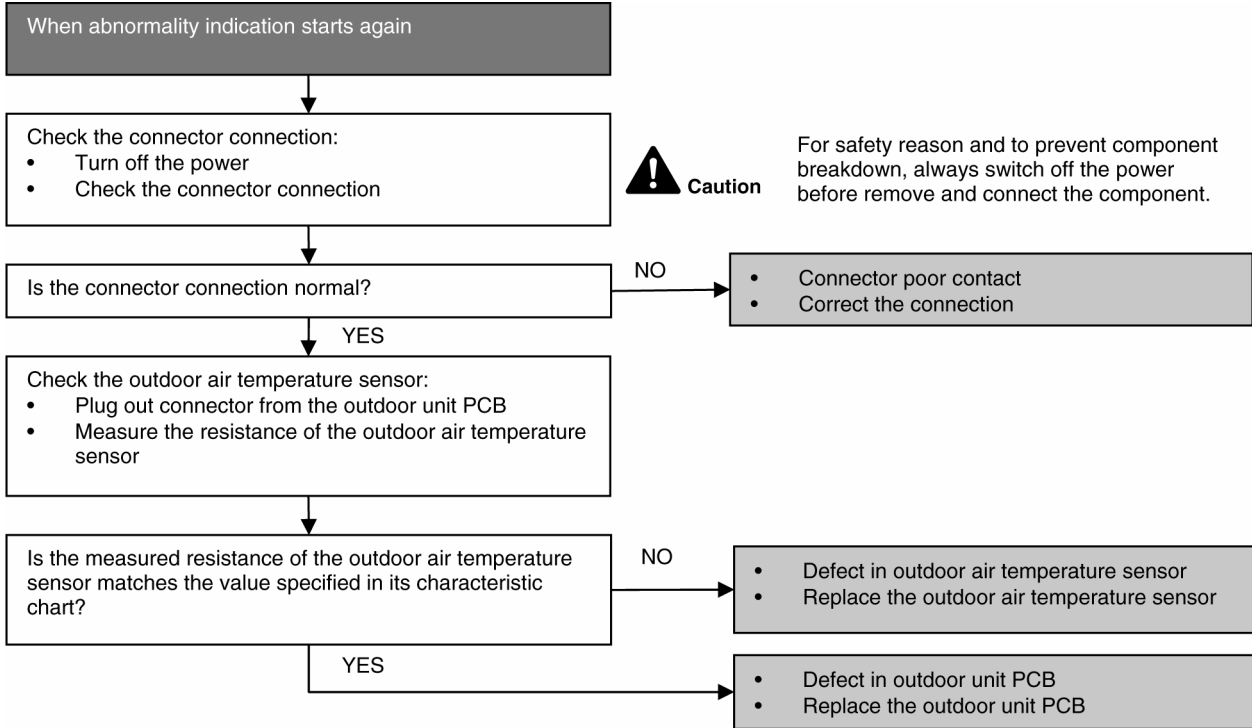

15.4.10 H28 (Outdoor Pipe Temperature Sensor Abnormality)

Malfunction Decision Conditions

- During startup and operation of cooling and heating, the temperatures detected by the outdoor pipe temperature sensor are used to determine sensor errors.

Malfunction Caused

- Faulty connector connection.
- Faulty sensor.
- Faulty PCB.

Troubleshooting

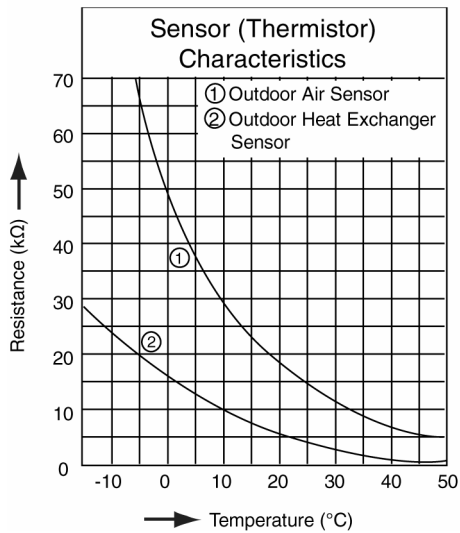
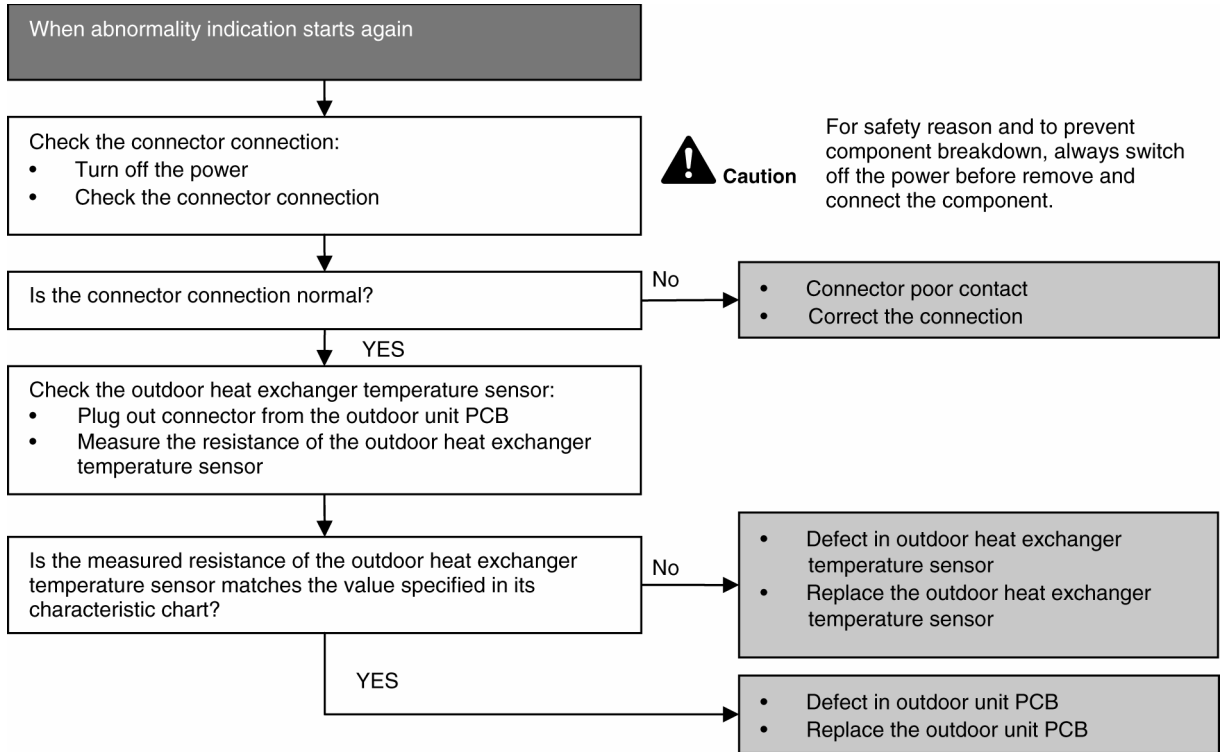

15.4.11 H30 (Compressor Discharge Temperature Sensor Abnormality)

Malfunction Decision Conditions

- During startup and operation of cooling and heating, the temperatures detected by the outdoor discharge pipe temperature sensor are used to determine sensor errors.

Malfunction Caused

- Faulty connector connection.
- Faulty sensor.
- Faulty PCB.

Troubleshooting

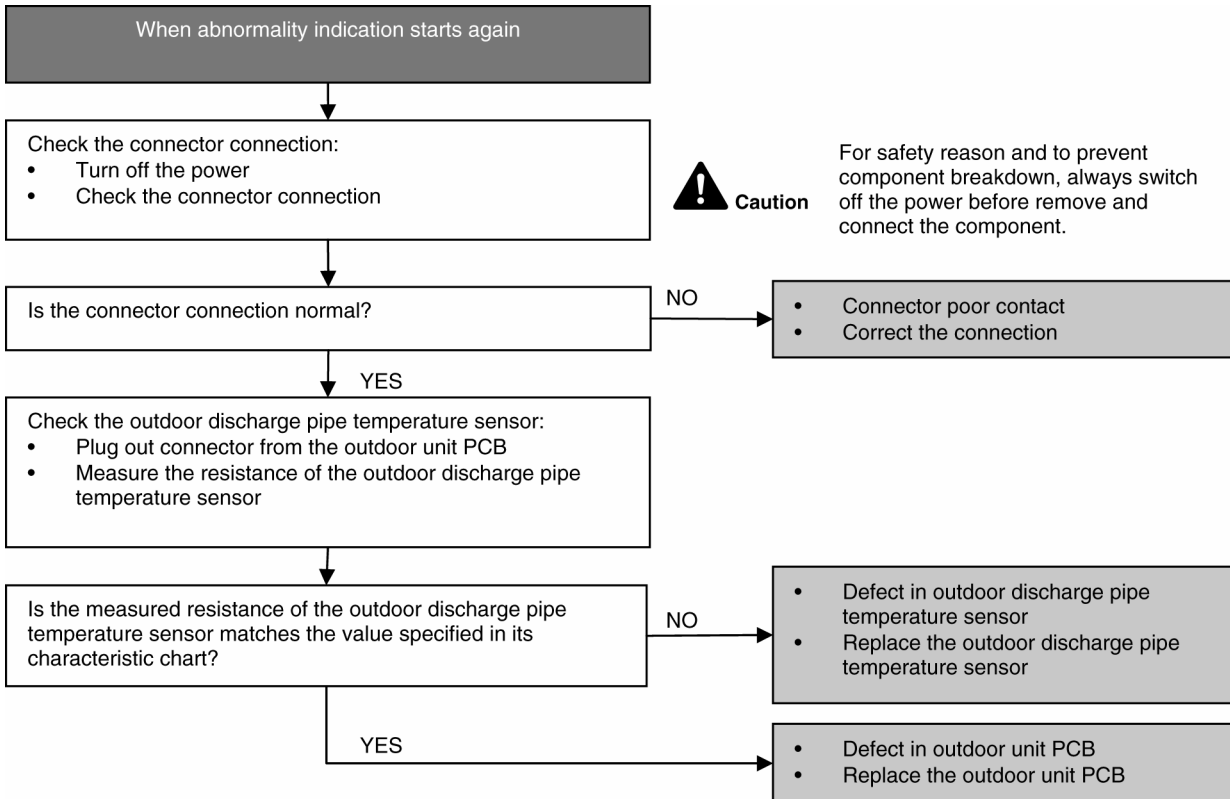

15.4.12 H33 (Unspecified Voltage between Indoor and Outdoor)

Malfunction Decision Conditions

- The supply power is detected for its requirement by the indoor/outdoor transmission.

Malfunction Caused

- Wrong models interconnected.
- Wrong indoor unit and outdoor unit PCBs used.
- Indoor unit or outdoor unit PCB defective.

Troubleshooting

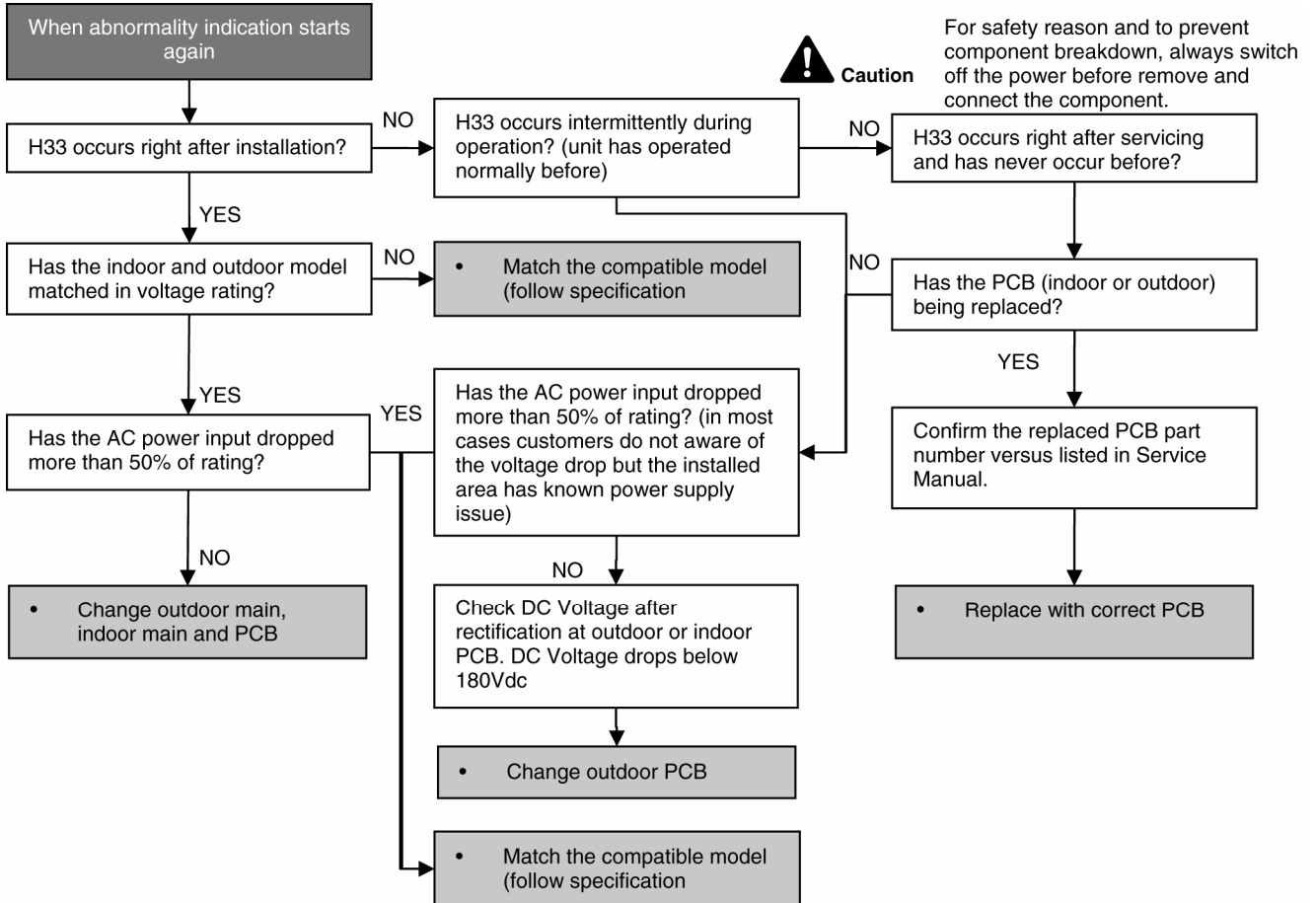

15.4.13 H58 (Patrol Sensor Abnormality)

Malfunction Decision Conditions

- If Patrol sensor feedback is 0V or 5V continuous for 6 hours.
- Error will display only when the Patrol operation is ON.

Malfunction Caused

- Faulty connector connection.
- Faulty Patrol sensor.

Troubleshooting

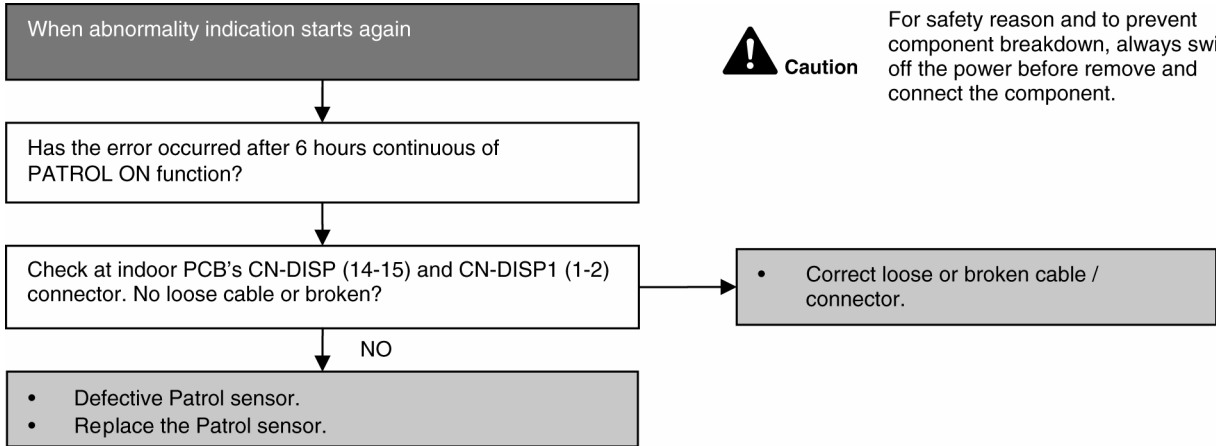

Caution

For safety reason and to prevent component breakdown, always switch off the power before remove and connect the component.

15.4.14 H97 (Outdoor Fan Motor – DC Motor Mechanism Locked)

Malfunction Decision Conditions

- The rotation speed detected by the Hall IC during fan motor operation is used to determine abnormal fan motor.

Malfunction Caused

- Operation stops due to short circuit inside the fan motor winding.
- Operation stops due to breaking of wire inside the fan motor.
- Operation stops due to breaking of fan motor lead wires.
- Operation stops due to Hall IC malfunction.
- Operation error due to faulty outdoor unit PCB.

Troubleshooting

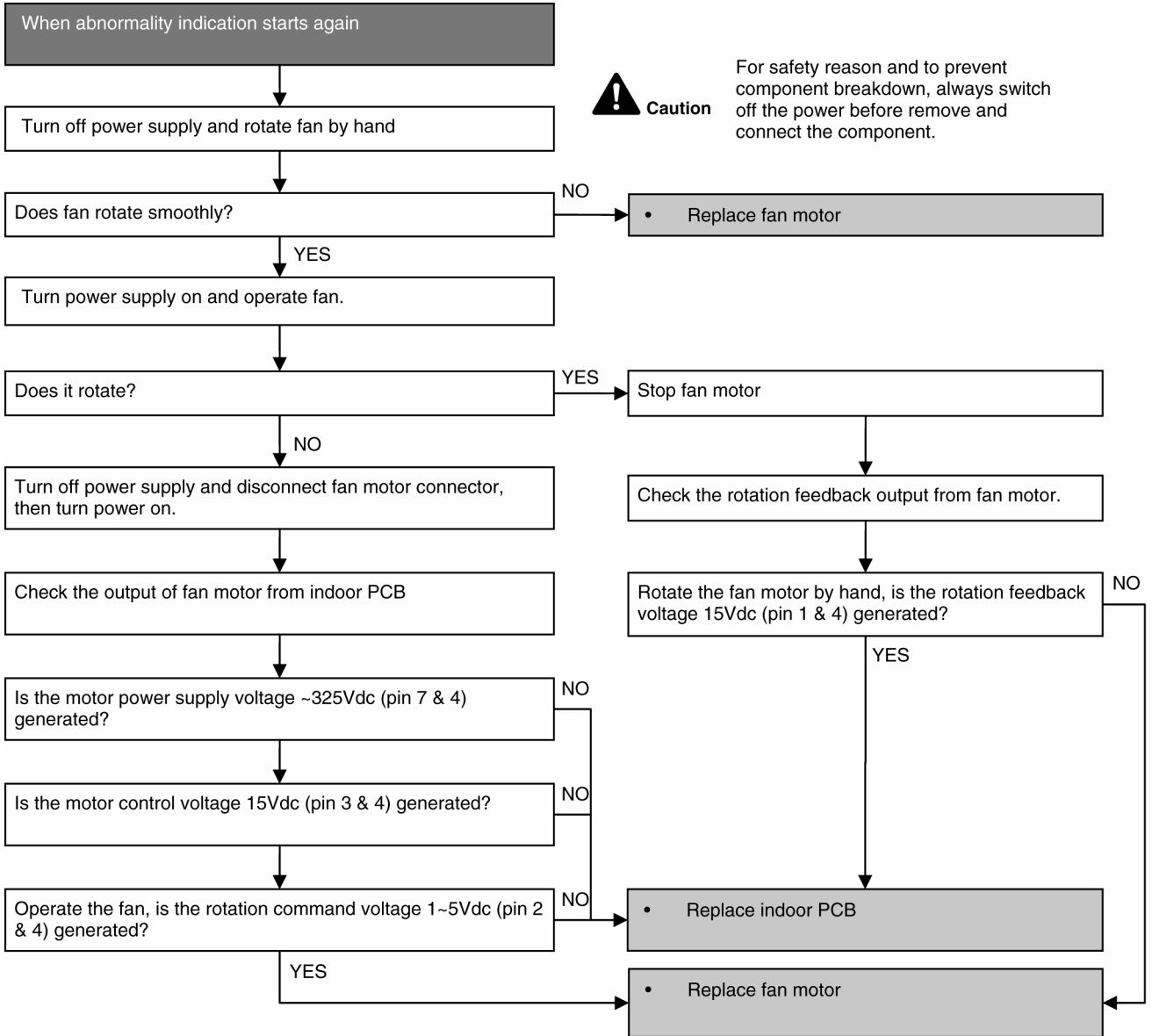

15.4.15 H98 (Indoor High Pressure Protection)

Error Code will not display (no Timer LED blinking) but store in EEPROM

Malfunction Decision Conditions

- During heating operation, the temperature detected by the indoor pipe temperature sensor is above 60°C.

Malfunction Caused

- Clogged air filter of the indoor unit
- Dust accumulation on the indoor unit heat exchanger
- Air short circuit
- Detection error due to faulty indoor pipe temperature sensor
- Detection error due to faulty indoor unit PCB

Troubleshooting

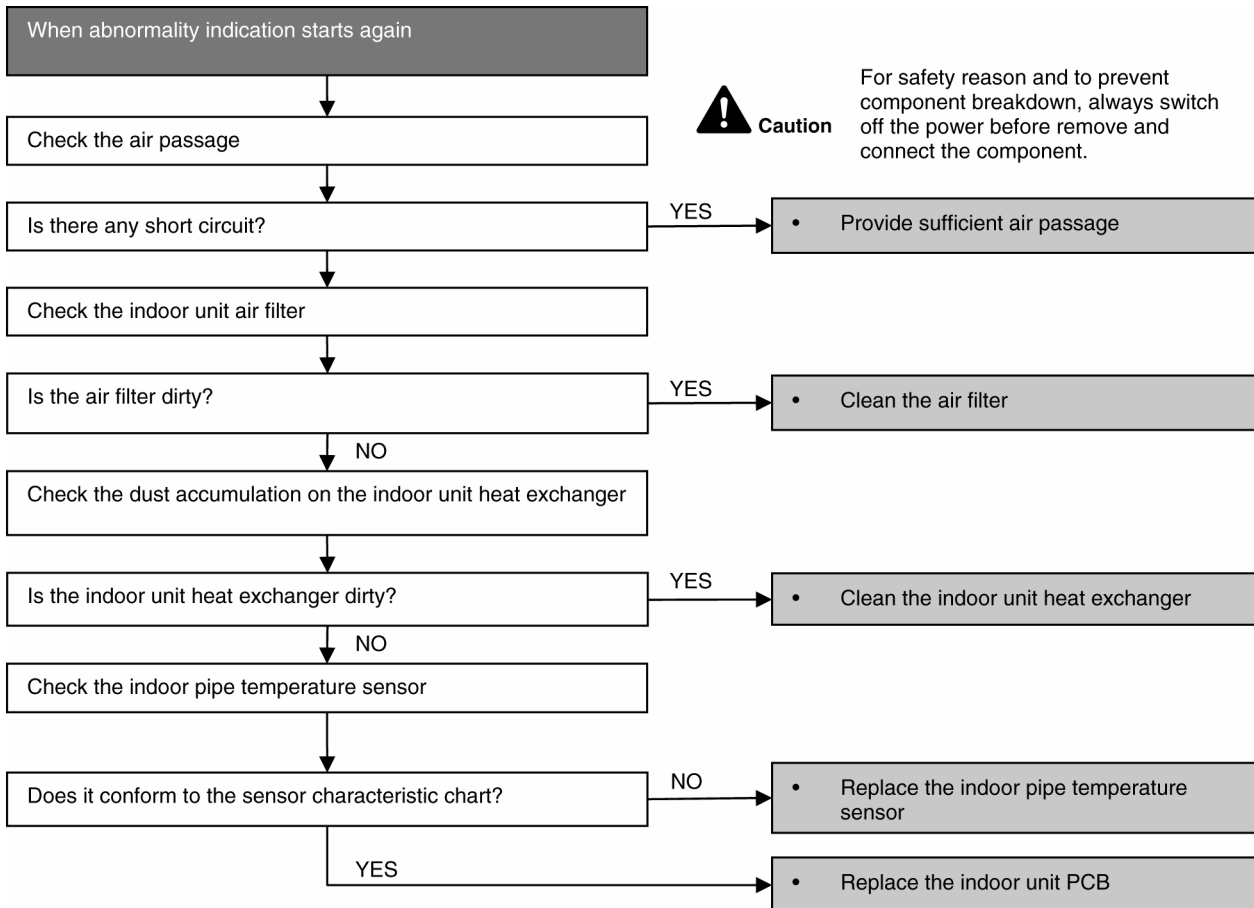

15.4.16 H99 (Indoor Freeze Prevention Protection: Cooling or Soft Dry)
Error Code will not display (no Timer LED blinking) but store in EEPROM

Malfunction Decision Conditions

- Freeze prevention control takes place (when indoor pipe temperature is lower than 2°C)

Malfunction Caused

- Clogged air filter of the indoor unit
- Dust accumulation on the indoor unit heat exchanger
- Air short circuit
- Detection error due to faulty indoor pipe temperature sensor
- Detection error due to faulty indoor unit PCB

Troubleshooting

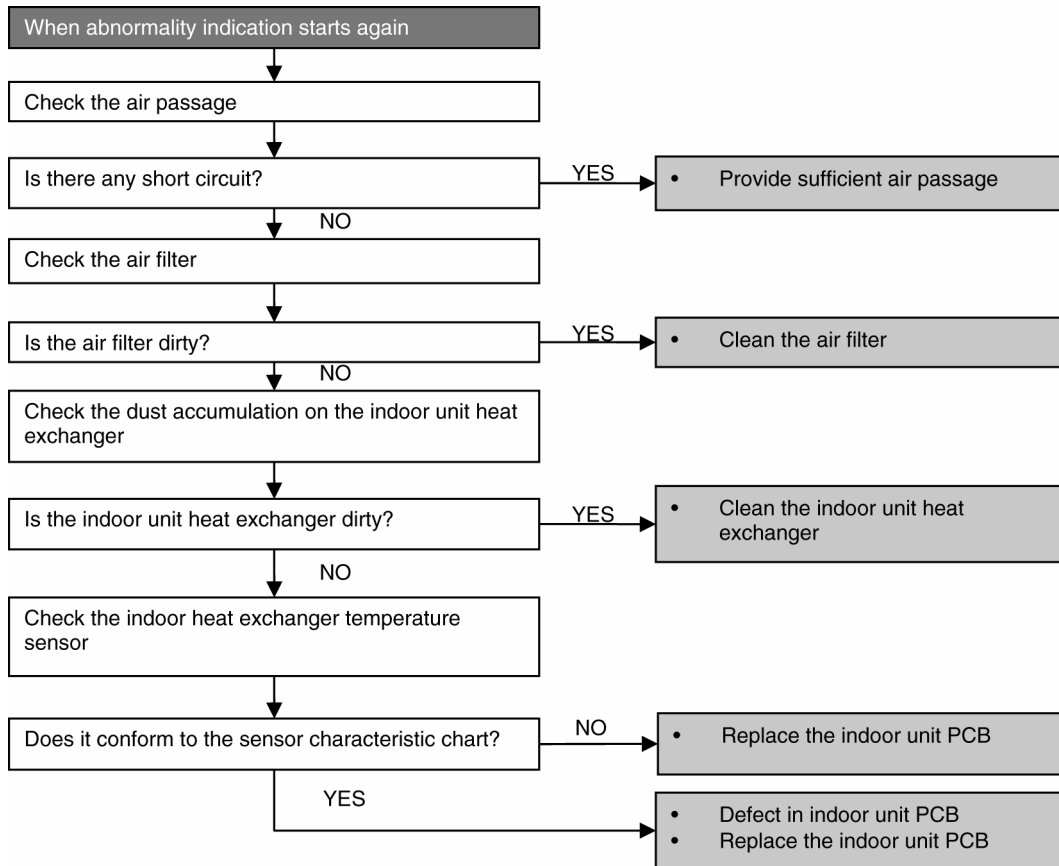

15.4.17 F11 (4-way valve Abnormality)

Malfunction Decision Conditions

- When heating operation, when indoor pipe temperature is below 10°C
- When cooling operation, when indoor pipe temperature is above 45°C

Malfunction Caused

- Connector in poor contact
- Faulty sensor
- Faulty outdoor unit PCB
- 4-way valve defective

Troubleshooting

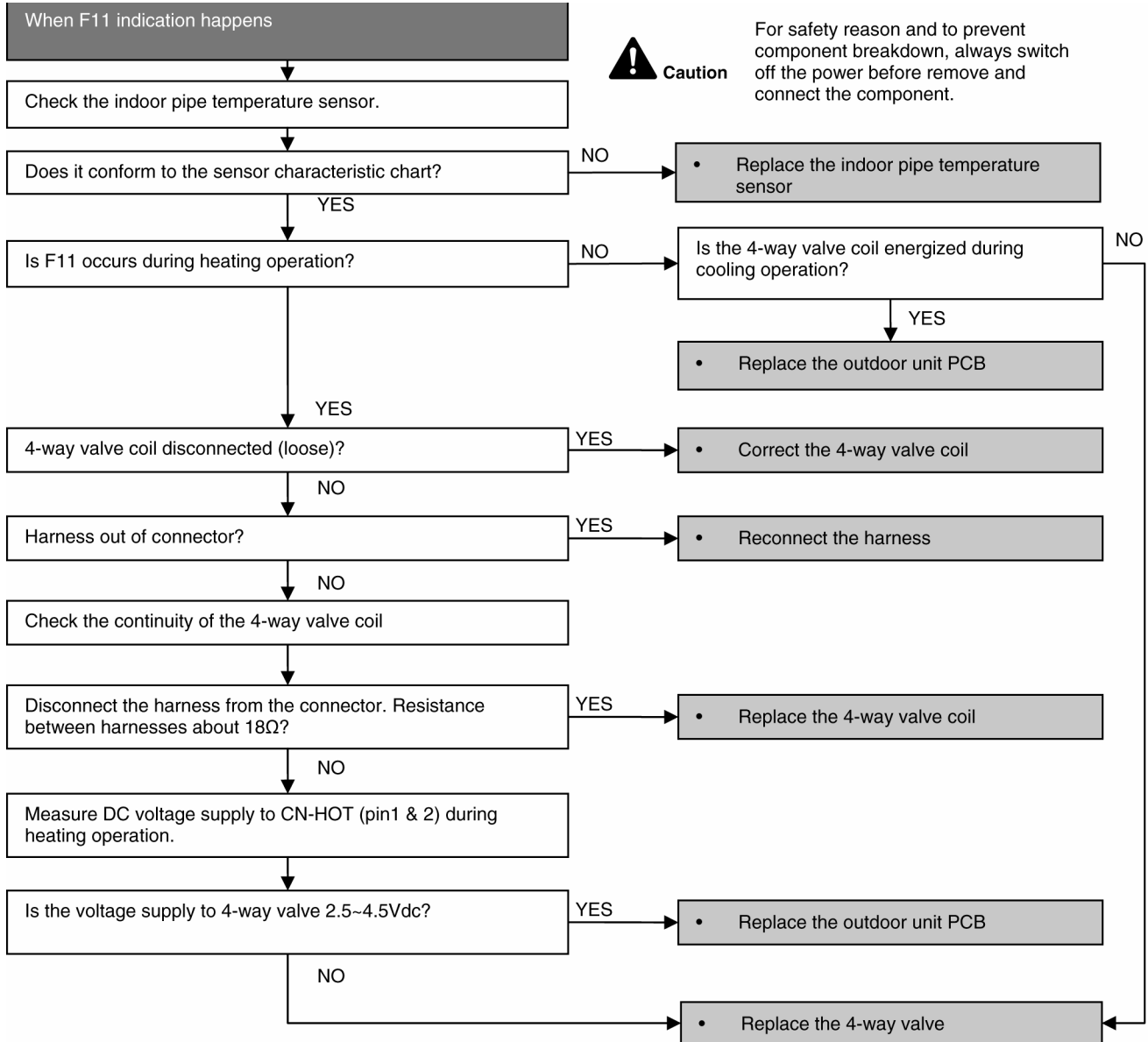

15.4.18 F90 (Power Factor Correction Protection)

Malfunction Decision Conditions

- During startup and operation of cooling and heating, when Power Factor Correction (PFC) protection circuitry at the outdoor unit main PCB senses abnormal high DC voltage level.

Malfunction Caused

- DC voltage peak due to power supply surge.
- DC voltage peak due to compressor windings not uniform.
- Faulty outdoor PCB.

Troubleshooting

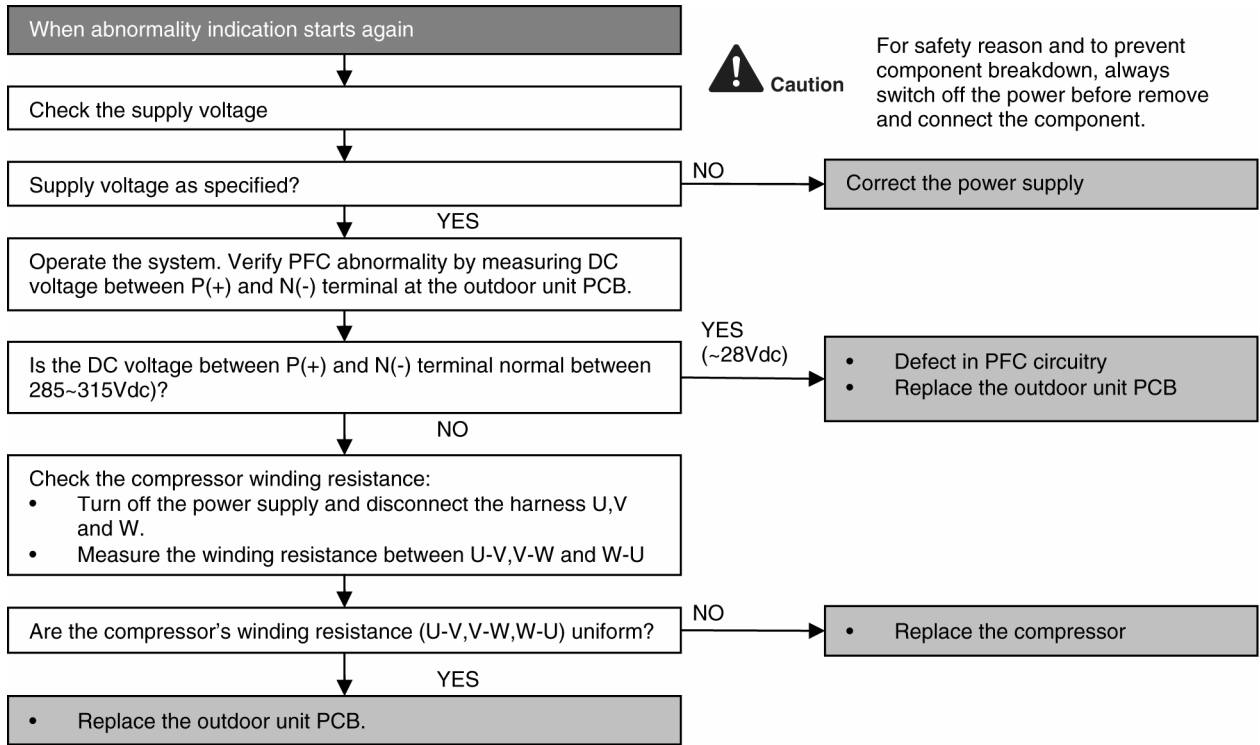

15.4.19 F91 (Refrigeration Cycle Abnormality)

Malfunction Decision Conditions

- During cooling, compressor frequency = F_{cmax}.
- During heating, compressor frequency > F_{hrated}.
- During cooling and heating operation, running current: $0.65A < I < 1.65A$.
- During cooling, indoor intake - indoor pipe < 4°C
- During heating, indoor pipe - indoor intake < 5°C

Multi Models Only

- Gas shortage detection 1: A gas shortage is detected by checking the CT-detected input current value and the compressor running frequency. During startup and operating of cooling and heating, input current < $8.78/256 (A/Hz) \times \text{compressor running frequency} + 0.25$.
- Gas shortage detection 2: A gas shortage is detected by checking the difference between indoor pipe temperature and indoor intake air temperature during cooling and heating.

Malfunction Caused

- Refrigerant shortage (refrigerant leakage)
- Poor compression performance of compressor.
- 2/3 way valve closed.
- Detection error due to faulty indoor intake air or indoor pipe temperature sensors.

Troubleshooting

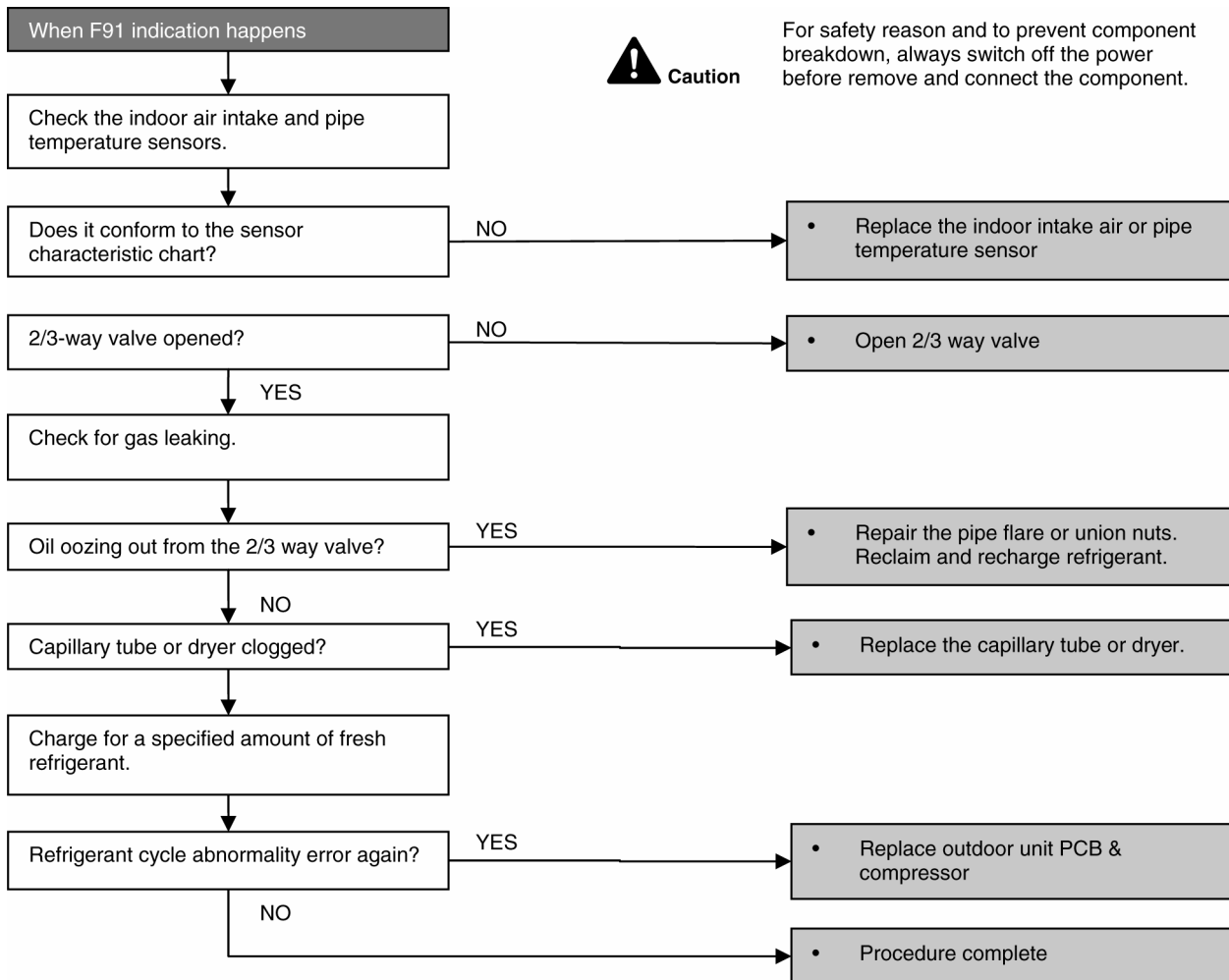

15.4.20 F93 (Compressor Rotation Failure)

Malfunction Decision Conditions

- A compressor rotation failure is detected by checking the compressor running condition through the position detection circuit.

Malfunction Caused

- Compressor terminal disconnect
- Outdoor PCB malfunction

Troubleshooting

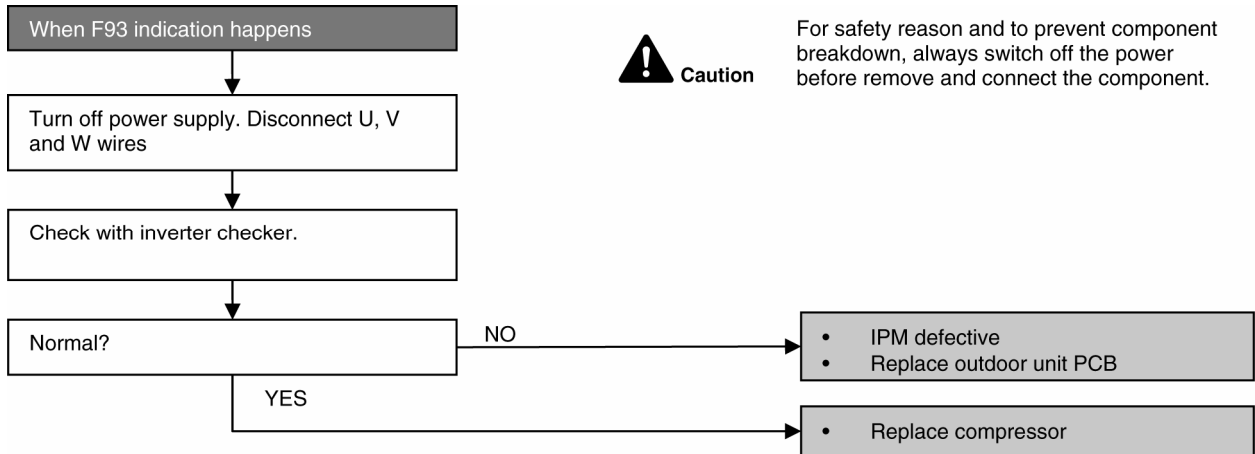

15.4.21 F95 (Cooling High Pressure Abnormality)

Malfunction Decision Conditions

- During operation of cooling, when outdoor unit heat exchanger high temperature data (61°C) is detected by the outdoor pipe temperature sensor.

Malfunction Caused

- Outdoor pipe temperature rise due to short circuit of hot discharge air flow.
- Outdoor pipe temperature rise due to defective of outdoor fan motor.
- Outdoor pipe temperature rise due to defective outdoor pipe temperature sensor.
- Outdoor pipe temperature rise due to defective outdoor unit PCB.

Troubleshooting

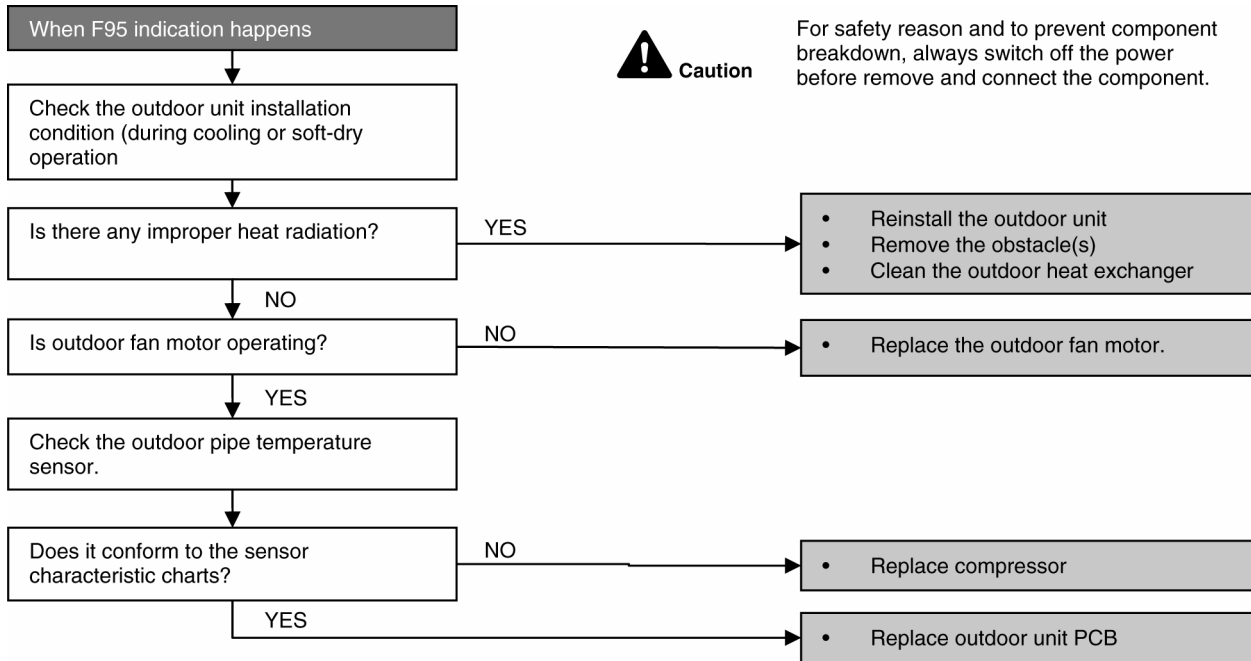

15.4.22 F96 (IPM Overheating)

Malfunction Decision Conditions

- During operating of cooling and heating, when IPM temperature data (100°C) is detected by the IPM temperature sensor.

Multi models only

- Compressor Overheating: During operation of cooling and heating, when the compressor OL is activated.
- Heat Sink Overheating: During operation of cooling and heating, when heat sink temperature data (90°C) is detected by the heat sink temperature sensor.

Malfunction Caused

- IPM overheats due to short circuit of hot discharge air flow.
- IPM overheats due to defective of outdoor fan motor.
- IPM overheats due to defective of internal circuitry of IPM.
- IPM overheats due to defective IPM temperature sensor.

Multi Models Only

- Compressor OL connector poor contact.
- Compressor OL faulty.

Troubleshooting

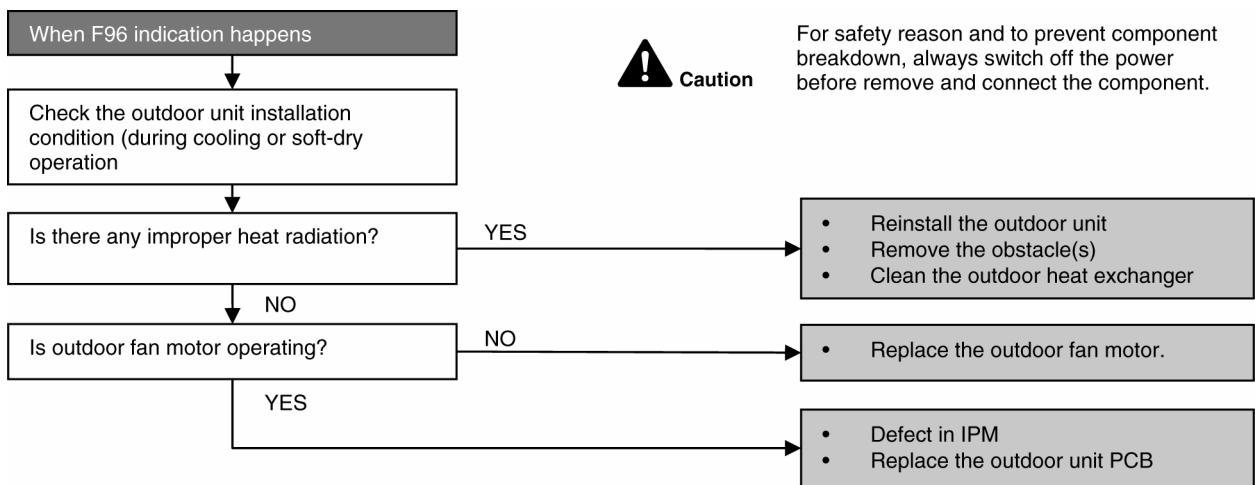

15.4.23 F97 (Compressor Overheating)

Malfunction Decision Conditions

- During operation of cooling and heating, when compressor tank temperature data (112°C) is detected by the compressor tank temperature sensor.

Malfunction Caused

- Refrigerant shortage (refrigerant leakage).
- 2/3 way valve closed.
- Detection error due to faulty compressor tank temperature sensor.

Troubleshooting

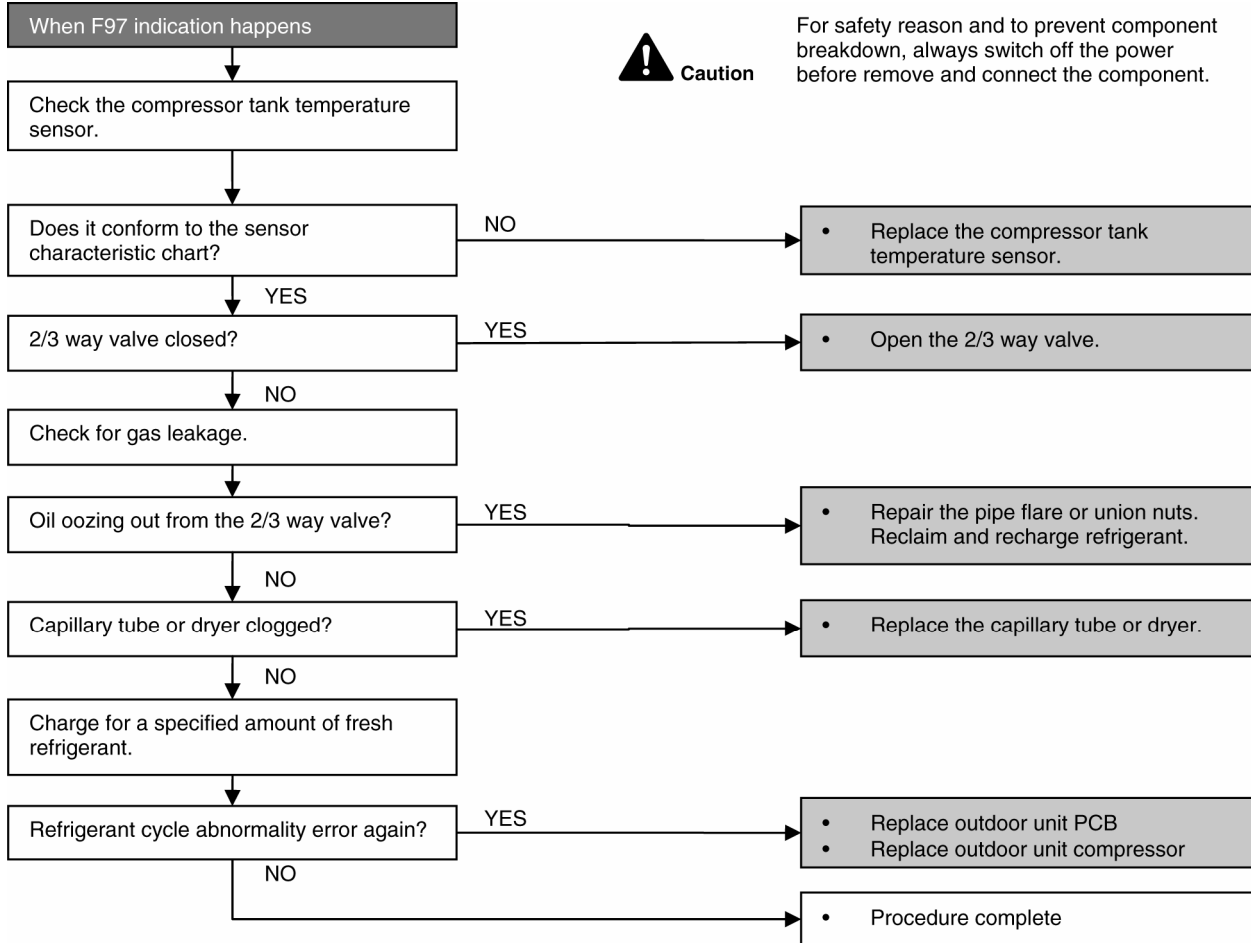

15.4.24 F98 (Input Over Current Detection)

Malfunction Decision Conditions

- During operation of cooling and heating, when an input over-current (16.8A) is detected by checking the input current value being detected by current transformer (CT) with the compressor running.

Malfunction Caused

- Over-current due to compressor failure.
- Over-current due to defective outdoor unit PCB.
- Over-current due to defective inverter main circuit electrolytic capacitor.
- Over-current due to excessive refrigerant.

Troubleshooting

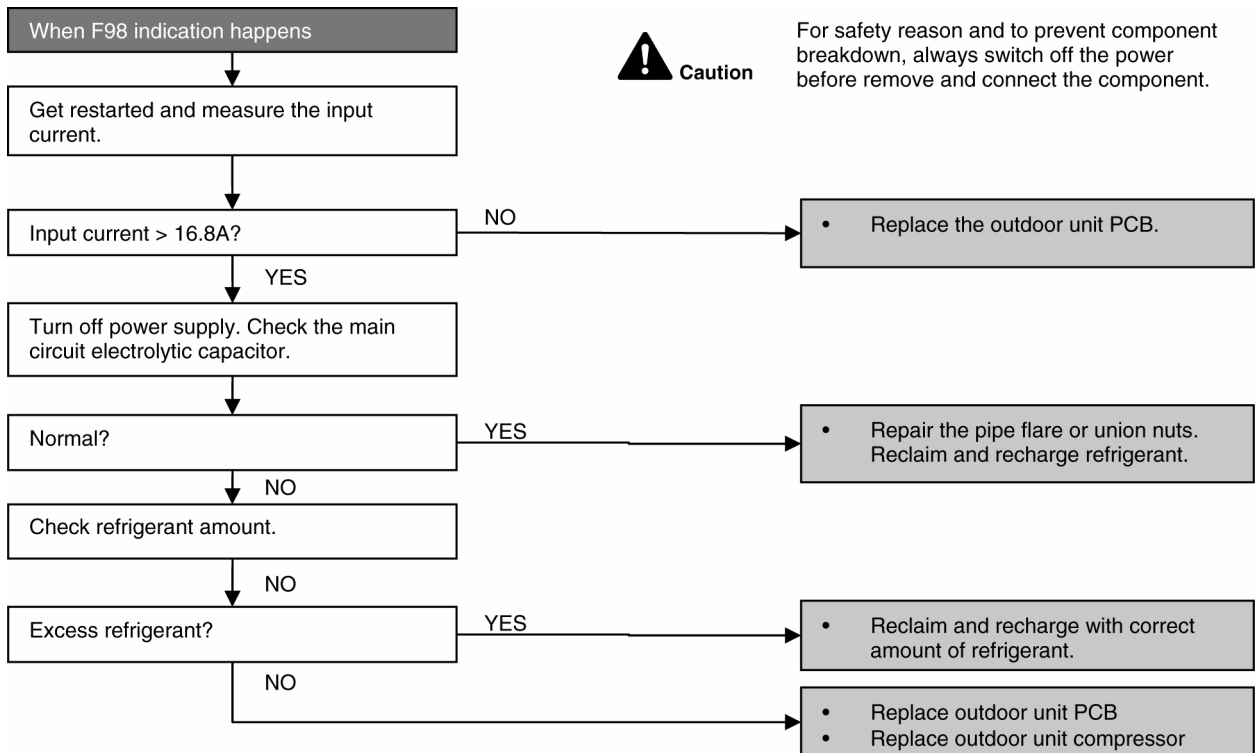

15.4.25 F99 (Output Over Current Detection)

Malfunction Decision Conditions

- During operation of cooling and heating, when an output over-current (18.5A) is detected by checking the current that flows in the inverter DC peak sensing circuitry.

Malfunction Caused

- DC peak due to compressor failure.
- DC peak due to defective power transistor(s).
- DC peak due to defective outdoor unit PCB.

Troubleshooting

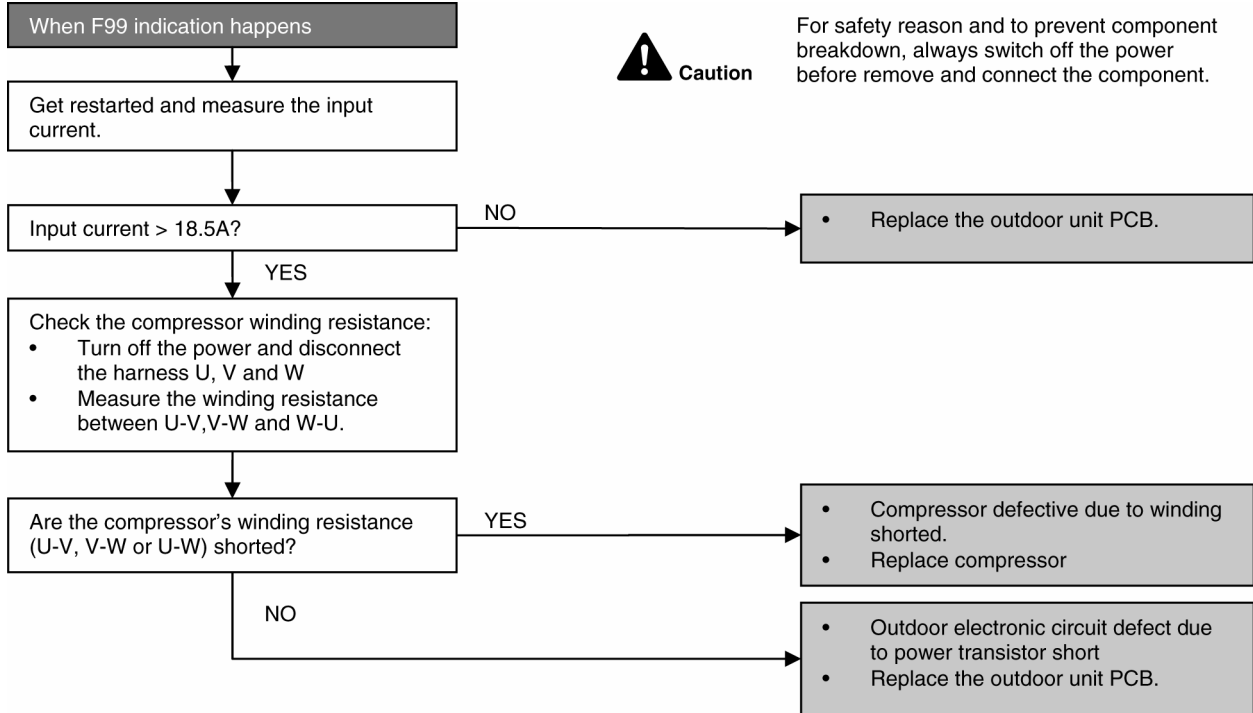

- Checking the power transistor
- Never touch any live parts for at least 10 minutes after turning off the circuit breaker.
- If unavoidable necessary to touch a live part, make sure the power transistor's supply voltage is below 50V using the tester.
- For the UVW, make measurement at the Faston terminal on the board of the relay connector.

Tester's negative terminal	Power transistor (+)	UVW	Power transistor (-)	UVW
Tester's positive terminal	UVW	Power transistor (+)	UVW	Power transistor (-)
Normal resistance	Several kΩ to several MΩ			
Abnormal resistance	0 or ∞			

16. Disassembly and Assembly Instructions



High Voltage is generated in the electrical parts area by the capacitor. Ensure that the capacitor has discharged sufficiently before proceeding with repair work. Failure to heed this caution may result in electric shocks.

16.1 Indoor Electronic Controllers, Cross Flow Fan and Indoor Fan Motor Removal Procedures

16.1.1 To remove front grille

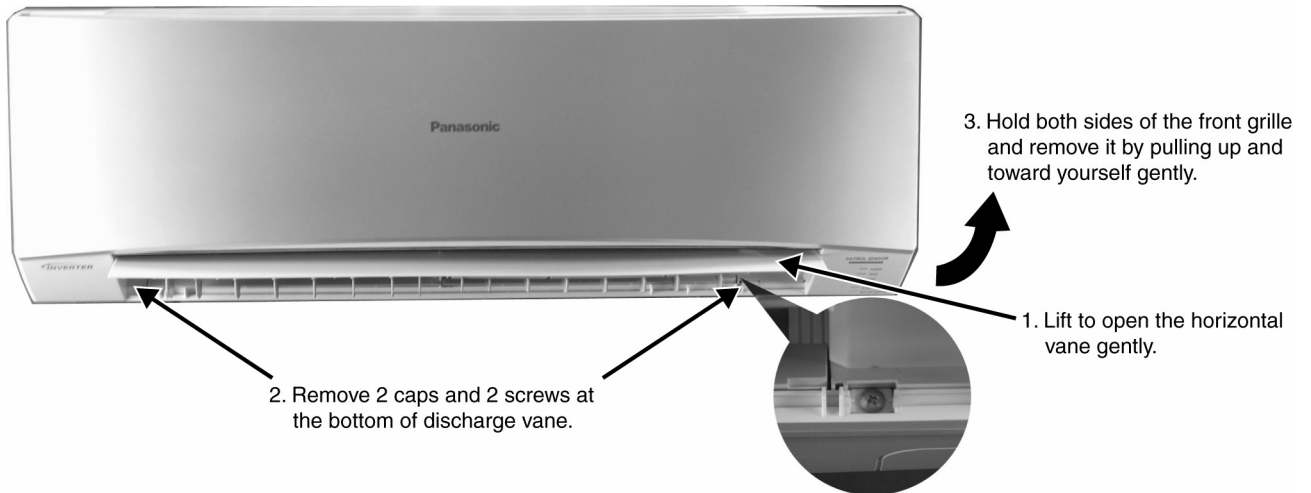

Figure 1

16.1.2 To remove power electronic controller

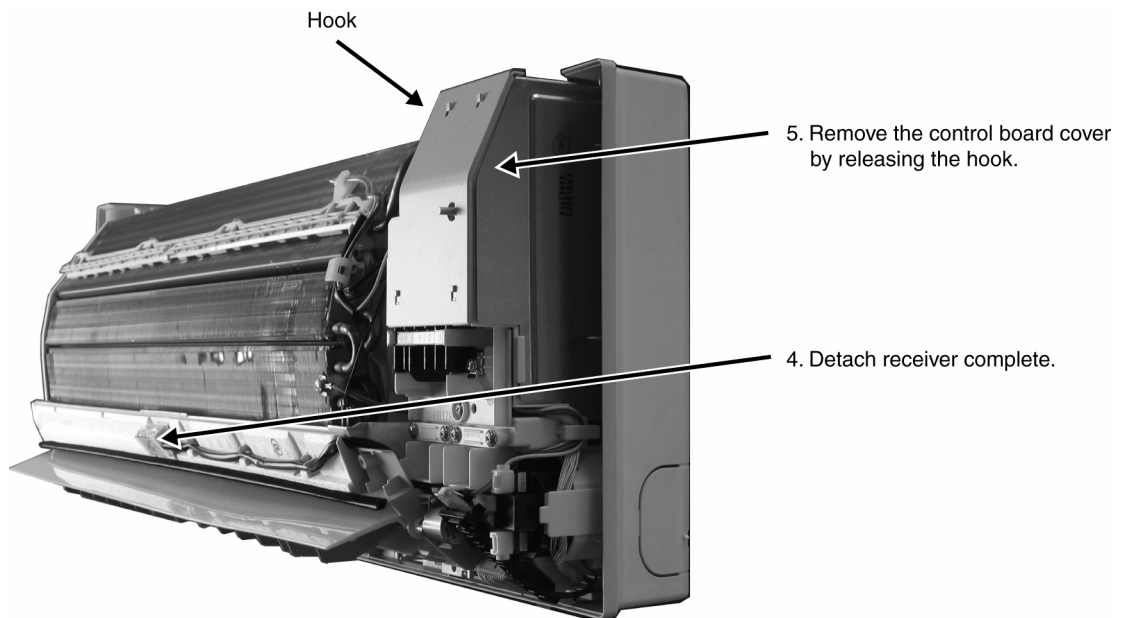

Figure 2

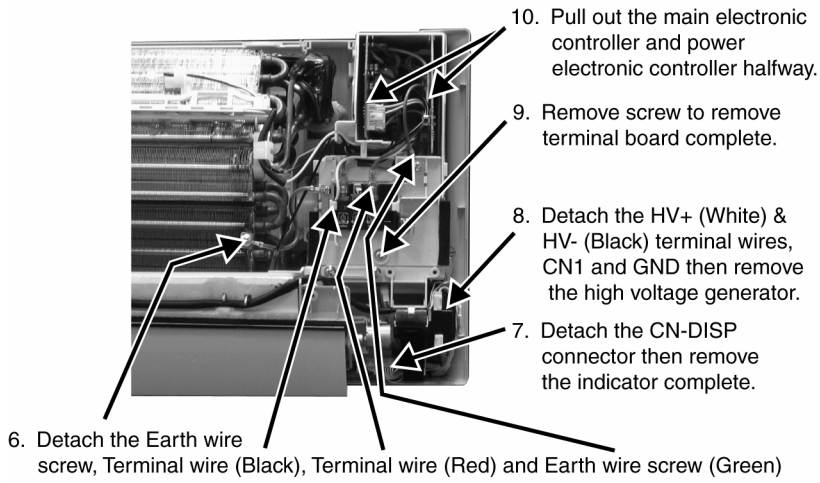

Figure 3

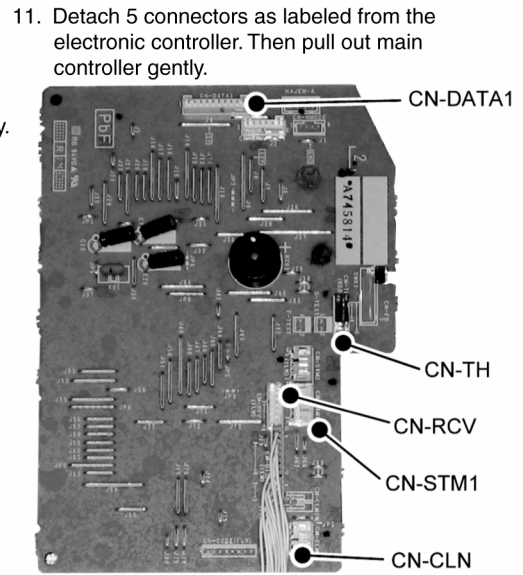

Figure 4

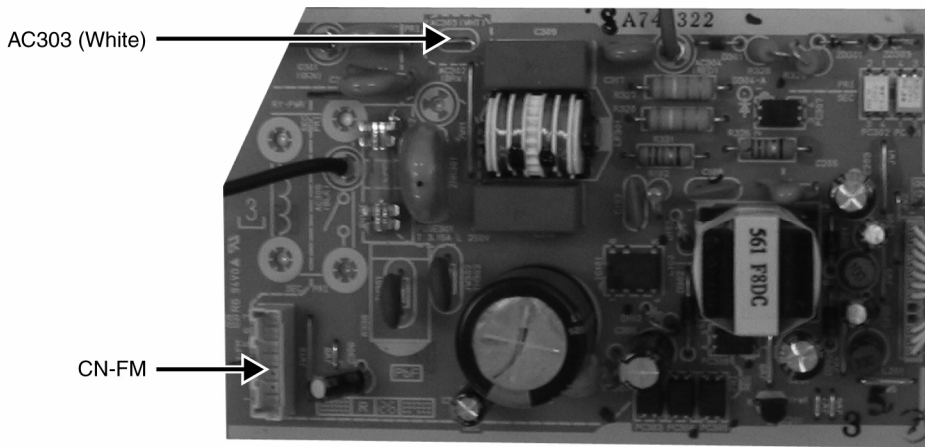

Figure 5

16.1.3 To remove discharge grille

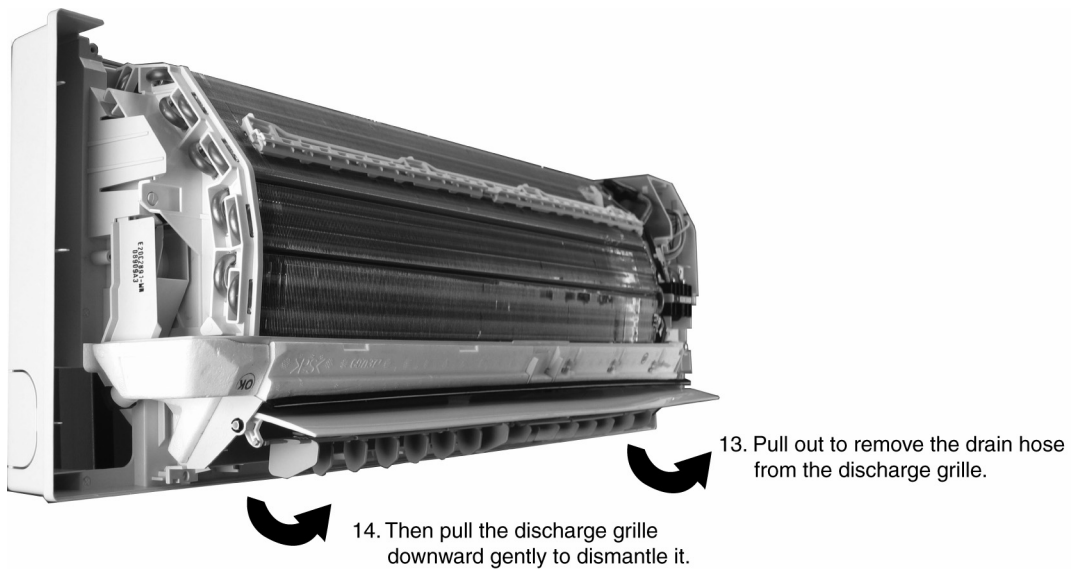

Figure 6

16.1.3.1 To remove control board

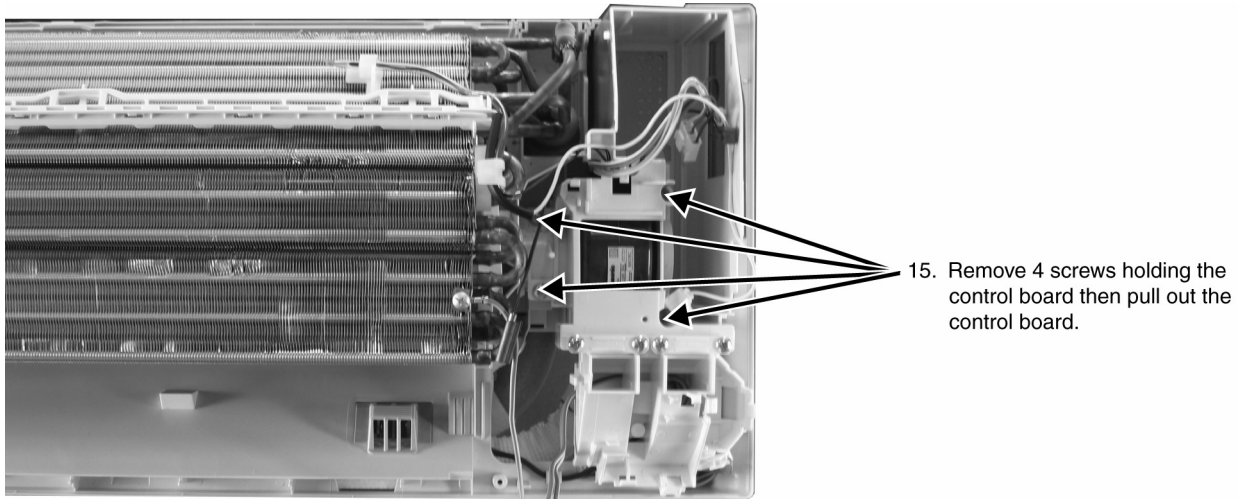

Figure 7

16.1.4 To remove cross flow fan and indoor fan motor

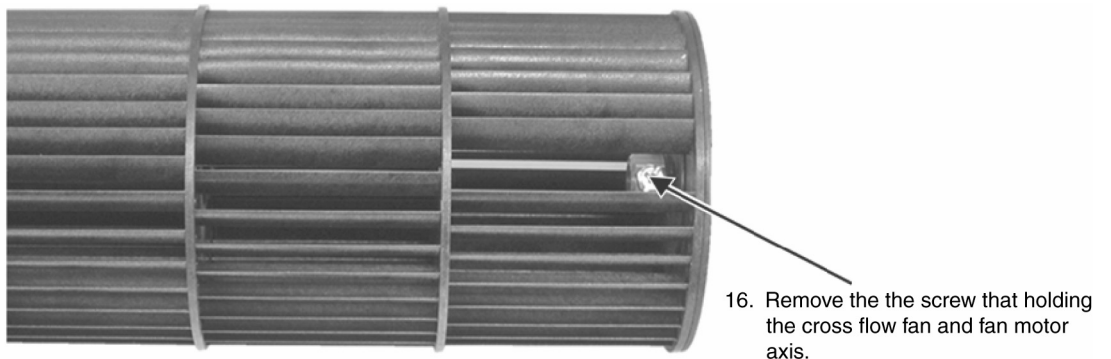

Figure 8

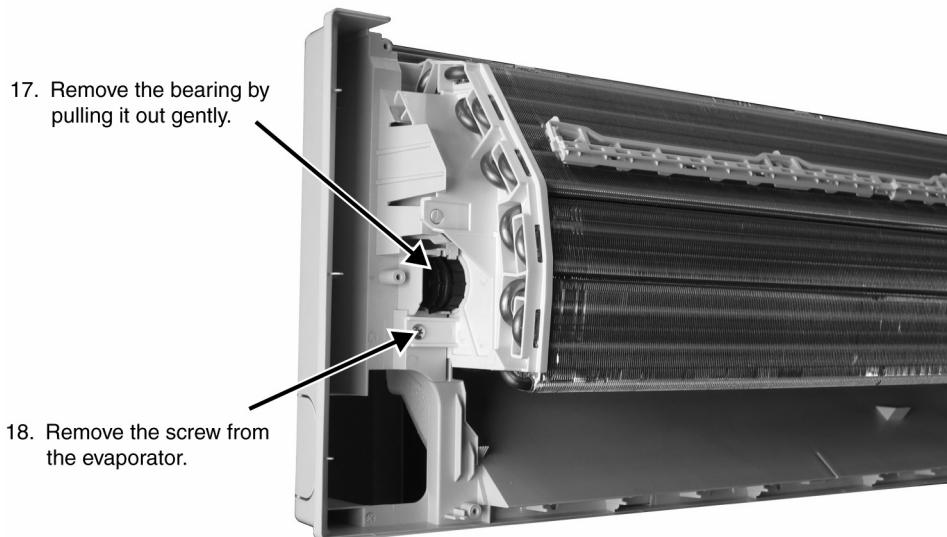

Figure 9

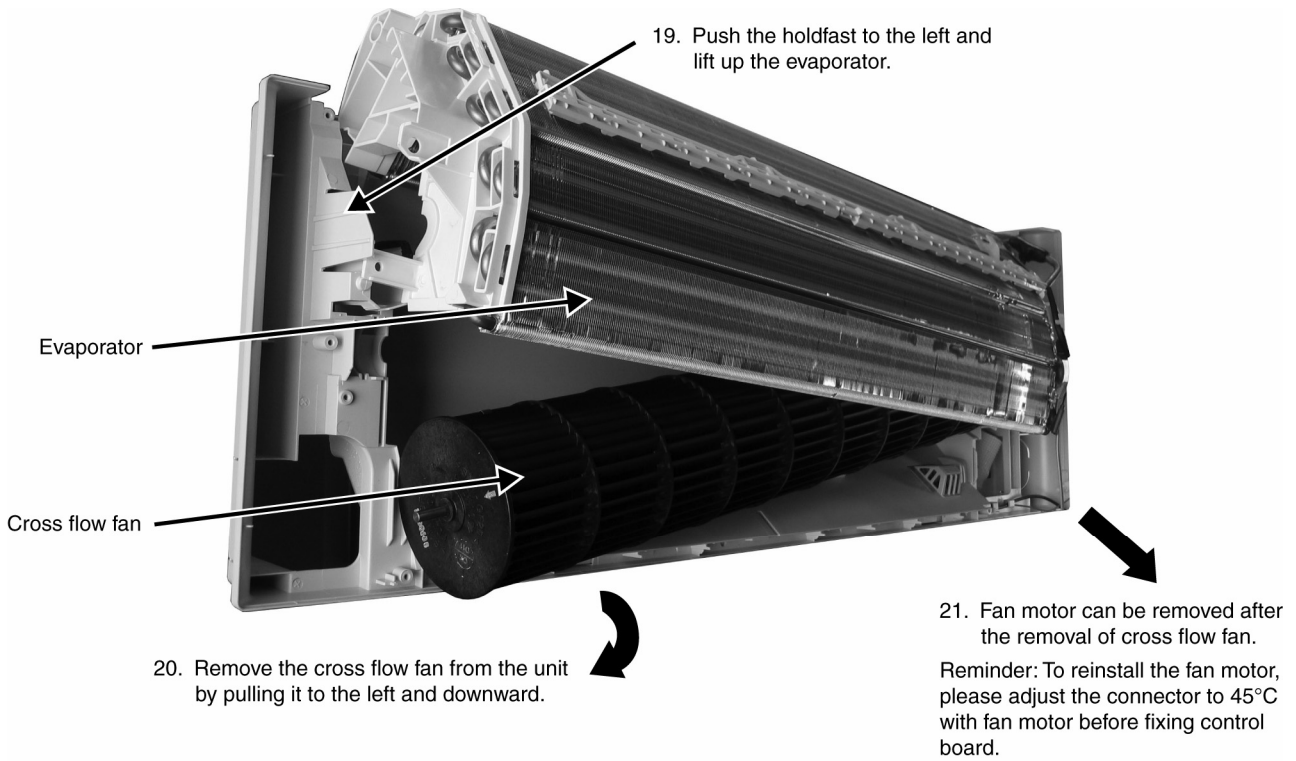

Figure 10

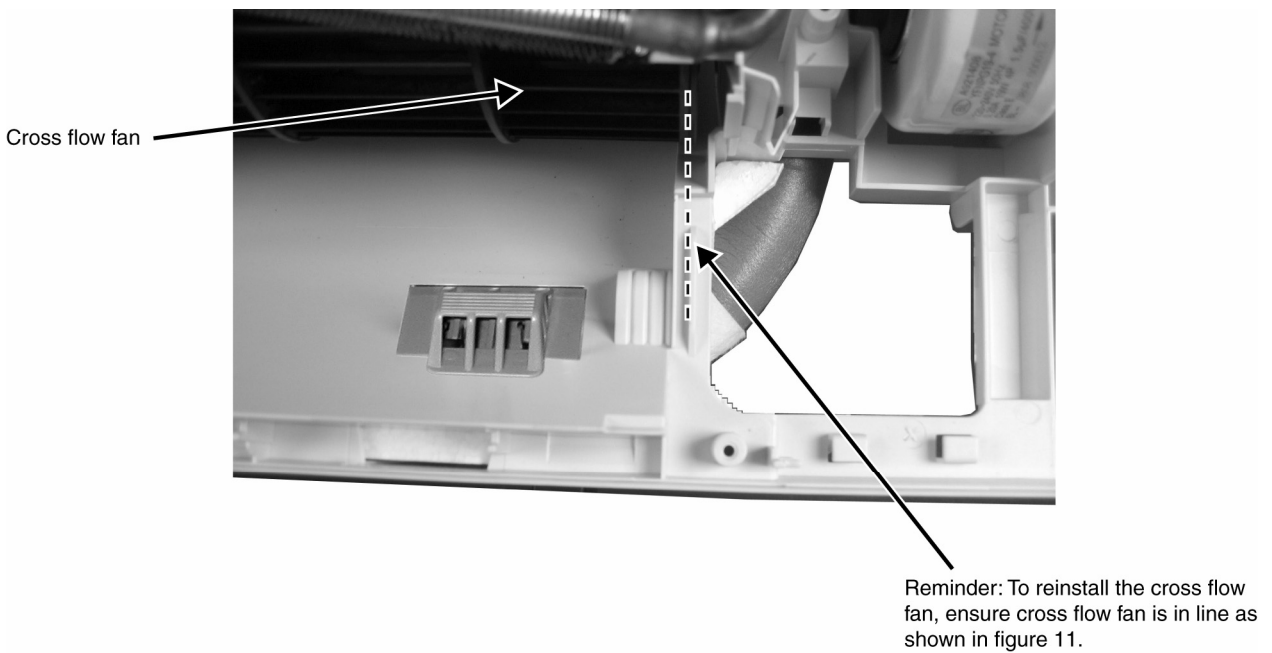

Figure 11

16.2 Outdoor Electronic Controller Removal Procedure

⚠ Caution! When handling electronic controller, be careful of electrostatic discharge.

1 Remove the 3 screws of the Top Panel.

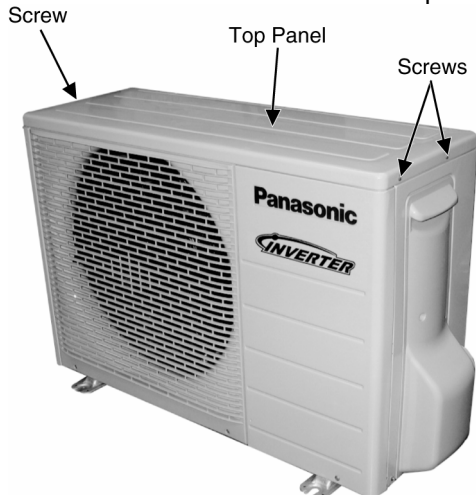

Fig.1

2 Remove the 6 screws of the Front Panel.

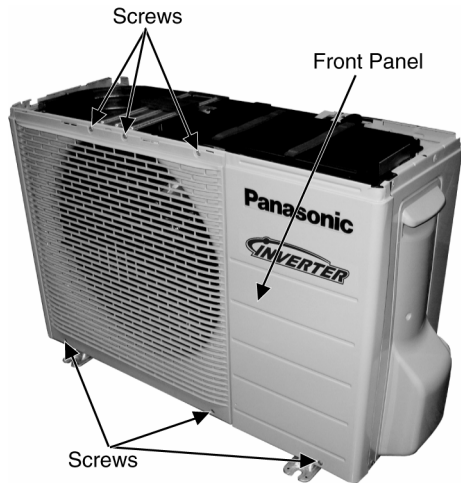

Fig.2

3 Remove the screw of the Terminal Board Cover.

4 Remove the Top Cover of the Control Board by 4 hooks.

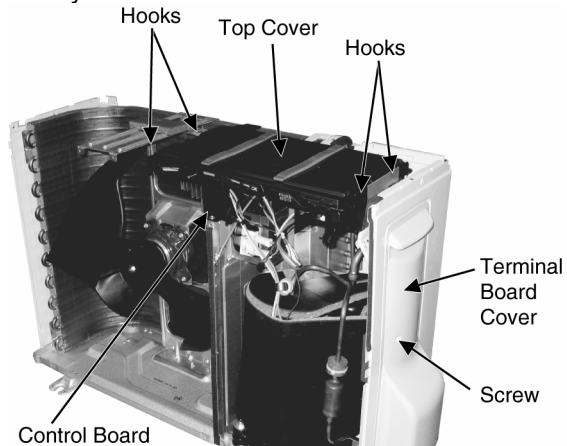

Fig.3

5 Remove the Control Board as follows:

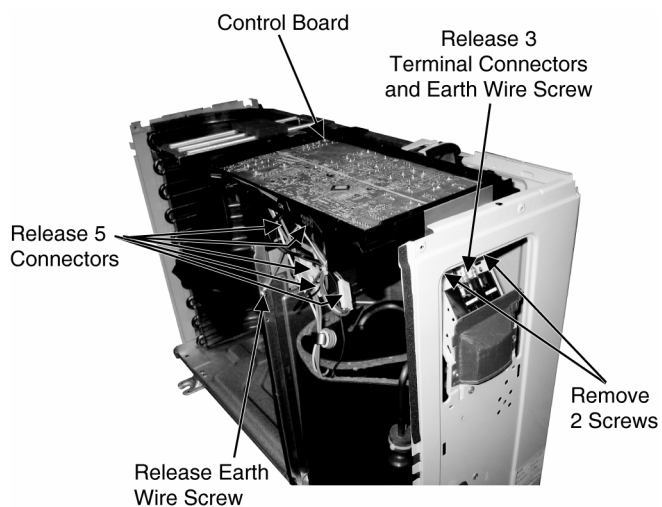

Fig.4

Remove the Terminal Cover and 3 Terminal Compressor

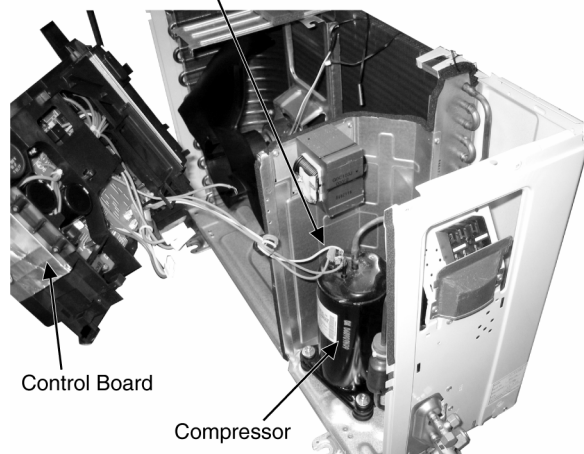

Fig.5

Electronic Controller Control Board

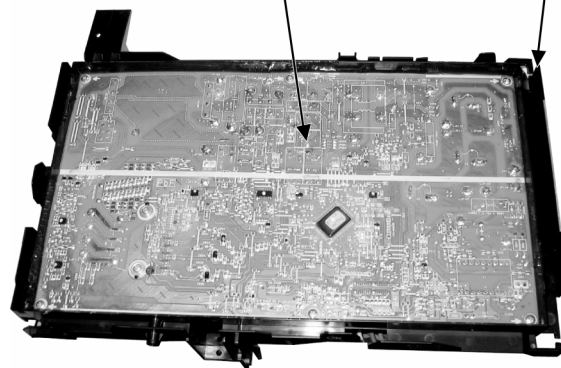

Fig.6

17. Technical Data

17.1 Operation Characteristics

17.1.1 CU-QE9MKE

• Cooling Characteristic

[Condition] Indoor temperature: 27/19°C
Remote condition: High fan speed, Cool 16°C
Comp. Hz: Rated F_c
Voltage: 230V

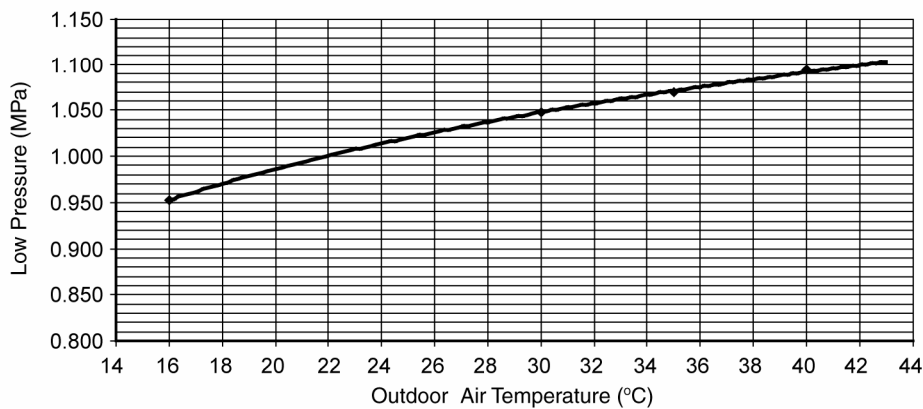
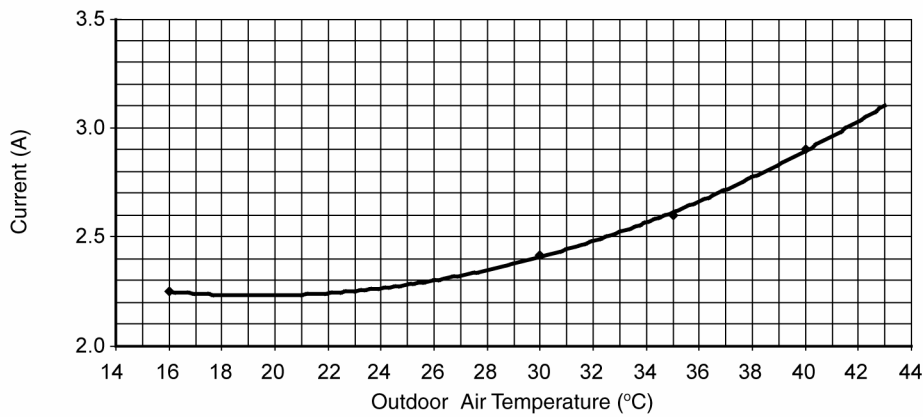
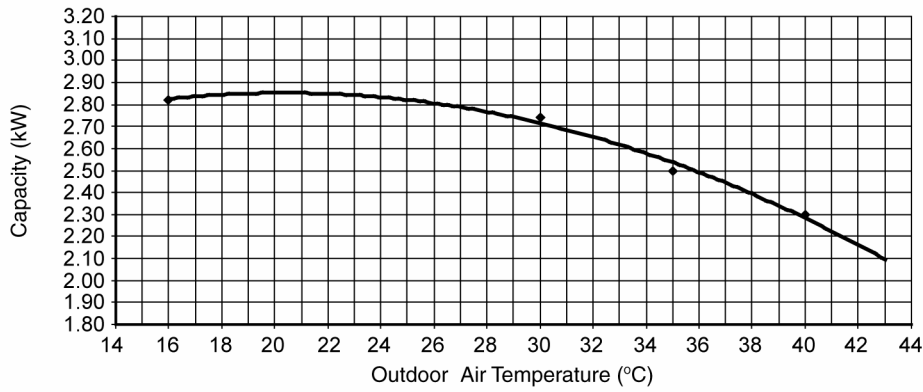
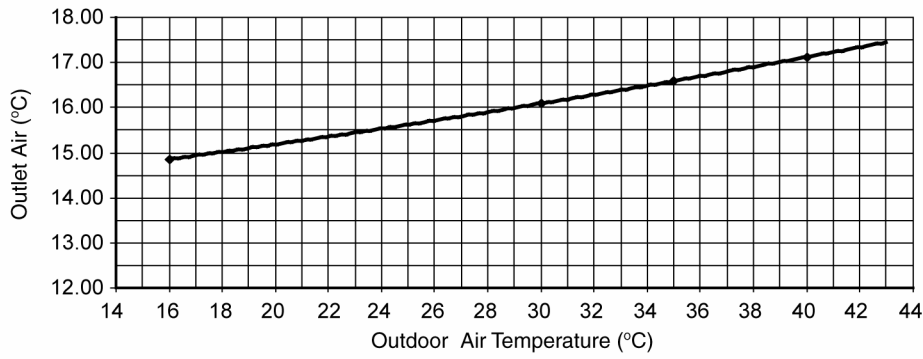

• Piping Length Characteristic

[Condition] Indoor temperature: 27/19°C, 35/-°C
 Remote condition: High fan speed, Cool 16°C
 Comp. Hz: Rated F_c
 Voltage: 230V

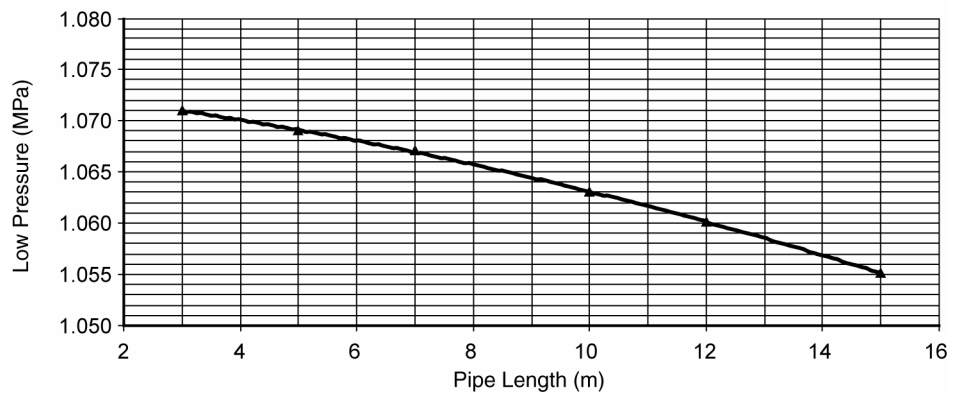
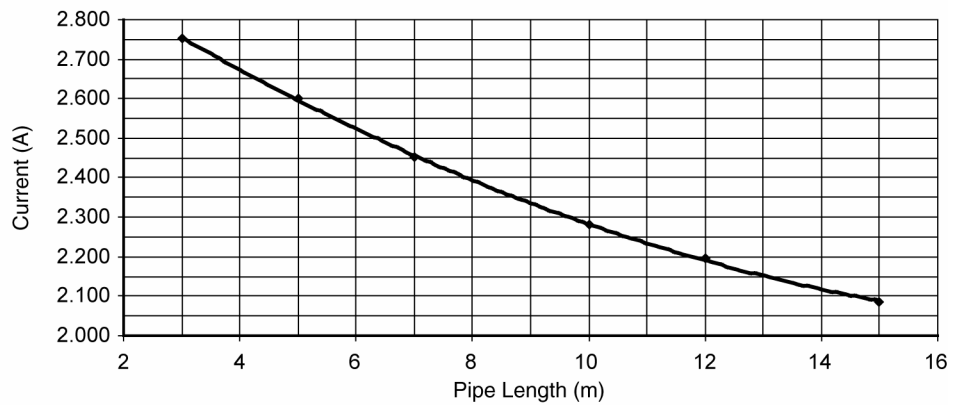
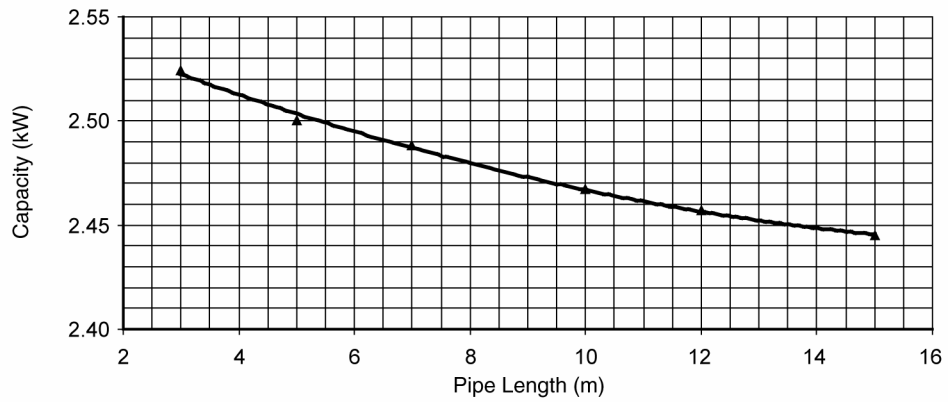
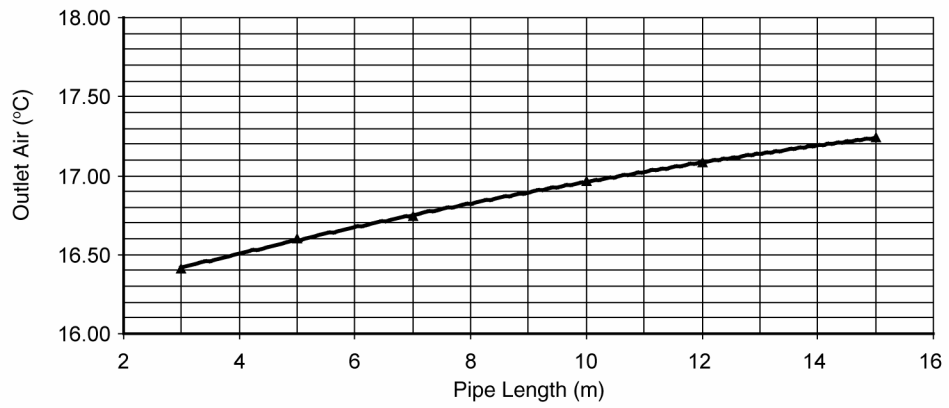

• Heating Characteristic

[Condition] Indoor temperature: 20/-°C

Remote condition: High fan speed, Heat 30°C

Comp. Hz: Rated F_h

Voltage: 230V

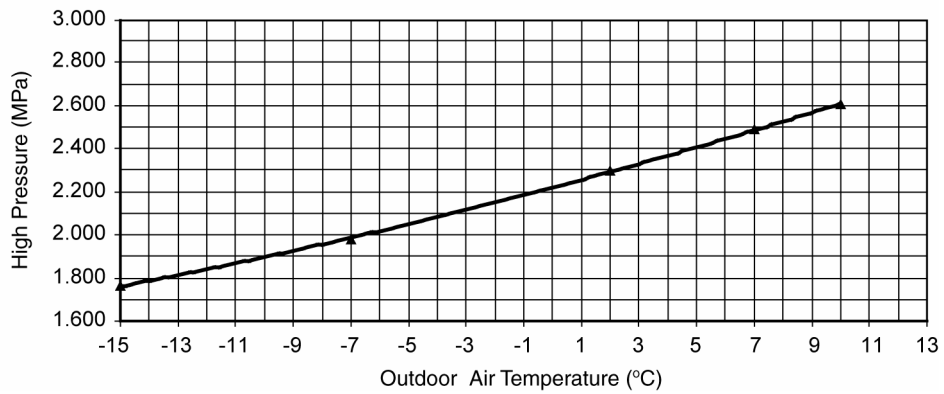
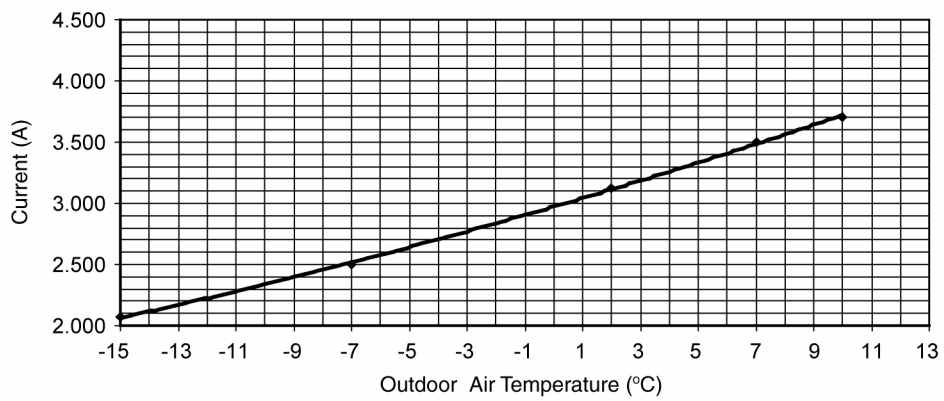
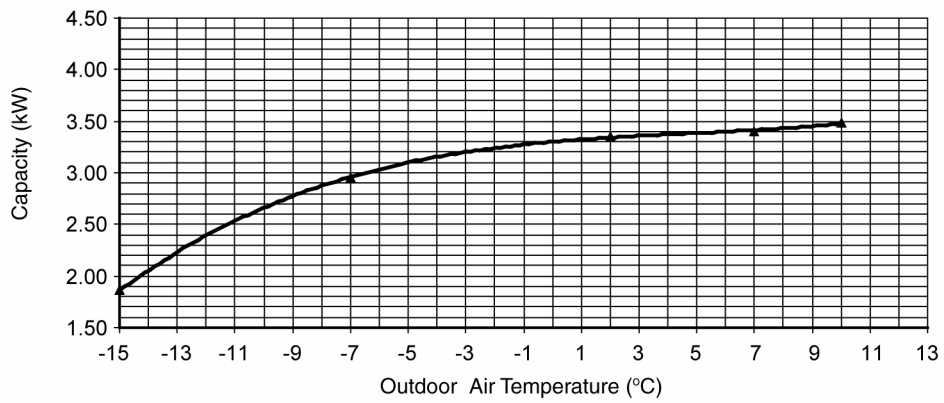
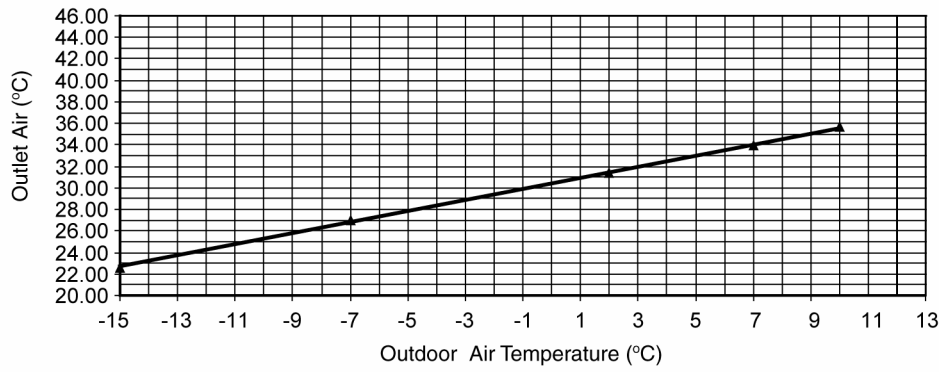

• Piping Length Characteristic

[Condition] Indoor temperature: 20/-°C, 7/6°C
Remote condition: High fan speed, Heat 30°C
Comp. Hz: Rated F_h
Voltage: 230V

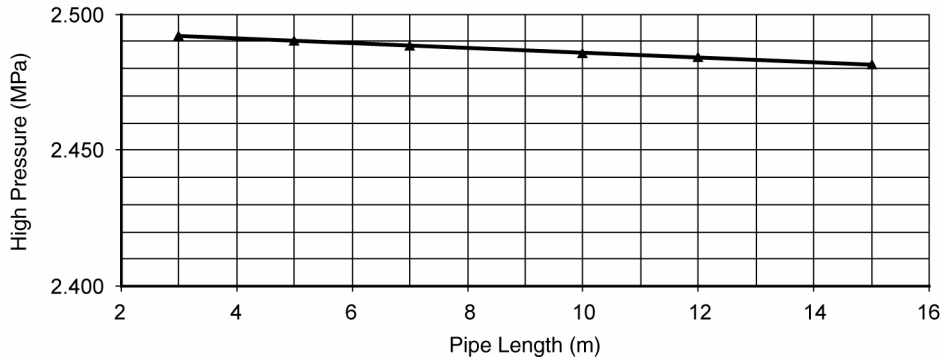
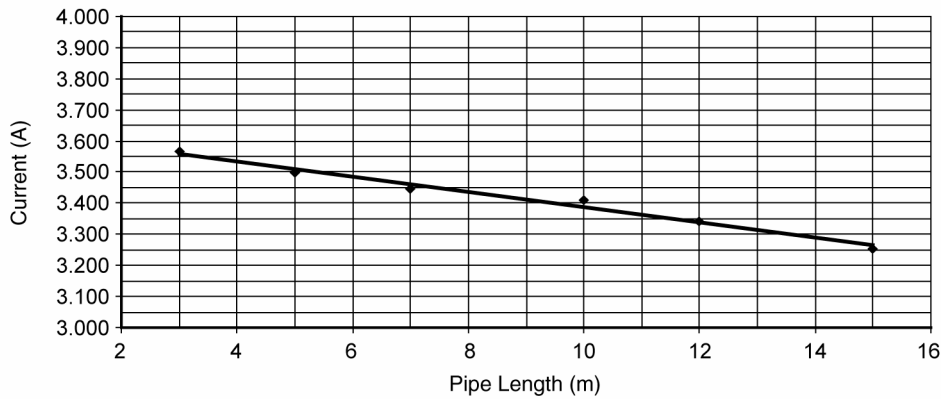
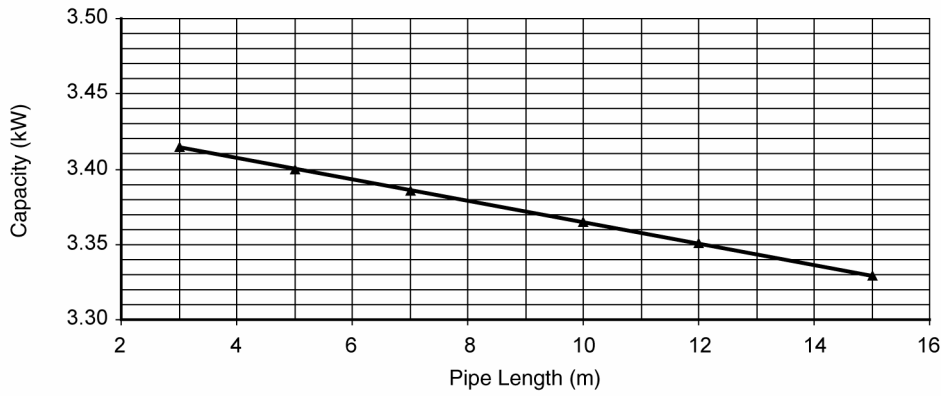
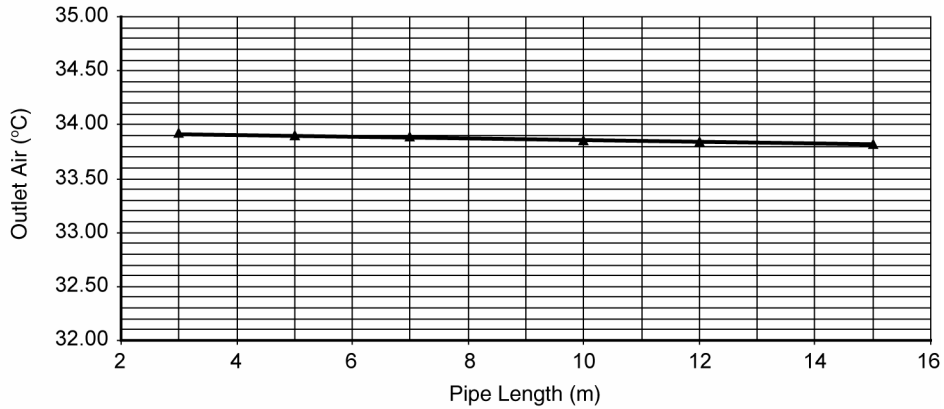

17.1.2 CU-QE12MKE

• Cooling Characteristic

[Condition] Indoor temperature: 27/19°C
Remote condition: High fan speed, Cool 16°C
Comp. Hz: Rated F_c
Voltage: 230V

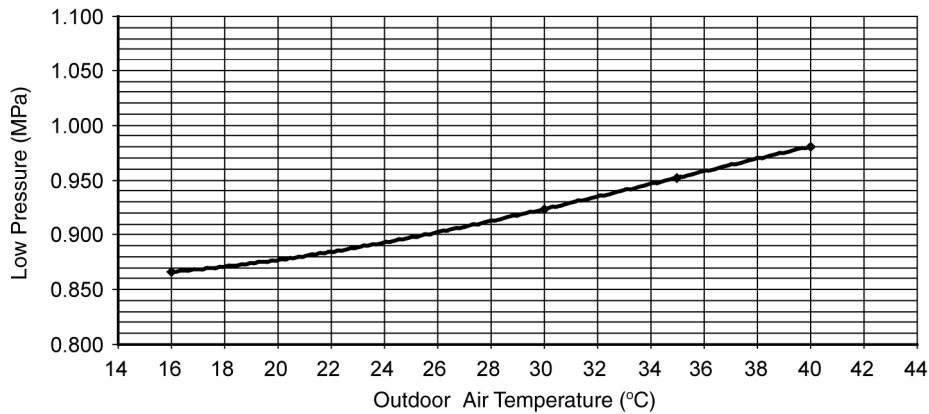
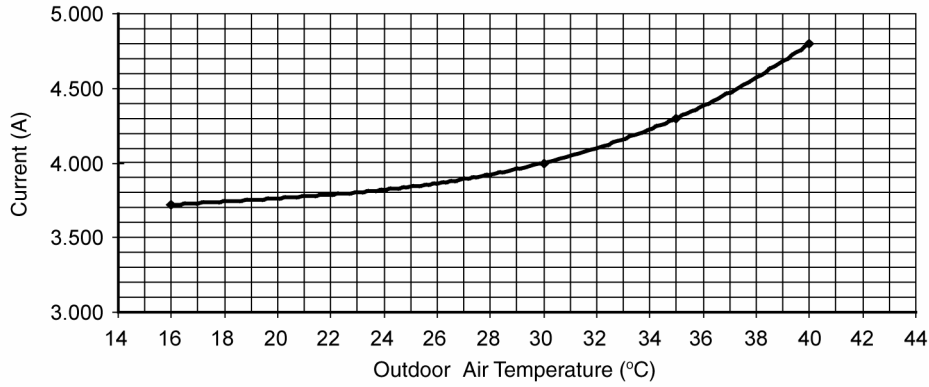
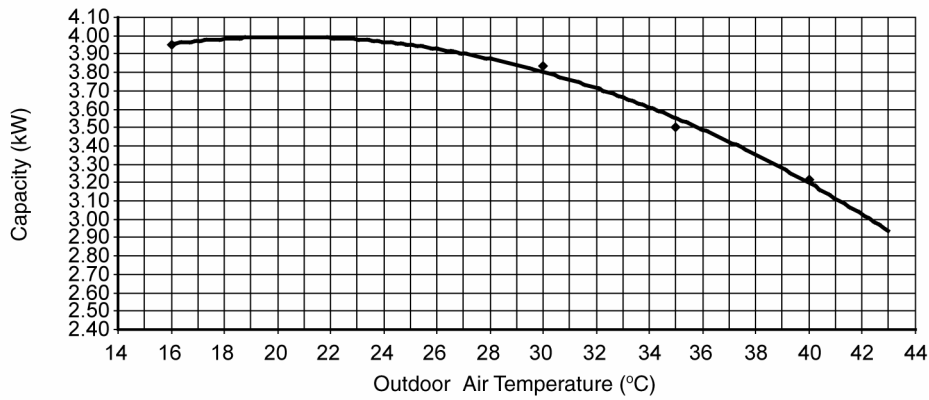
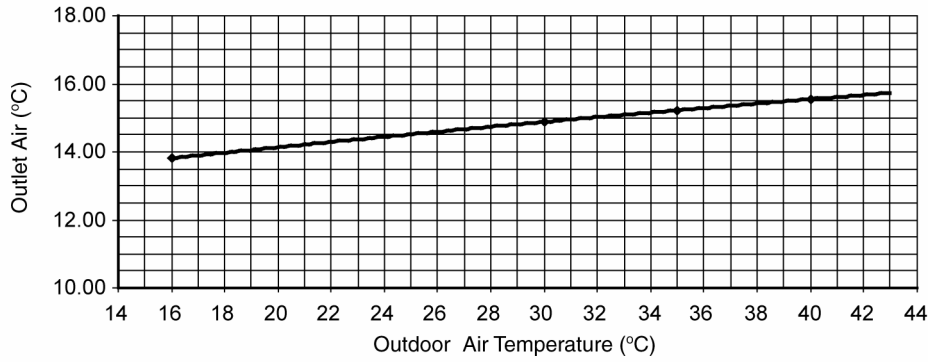

• Piping Length Characteristic

[Condition] Indoor temperature: 27/19°C, 35/-°C
 Remote condition: High fan speed, Cool 16°C
 Comp. Hz: Rated F_c
 Voltage: 230V

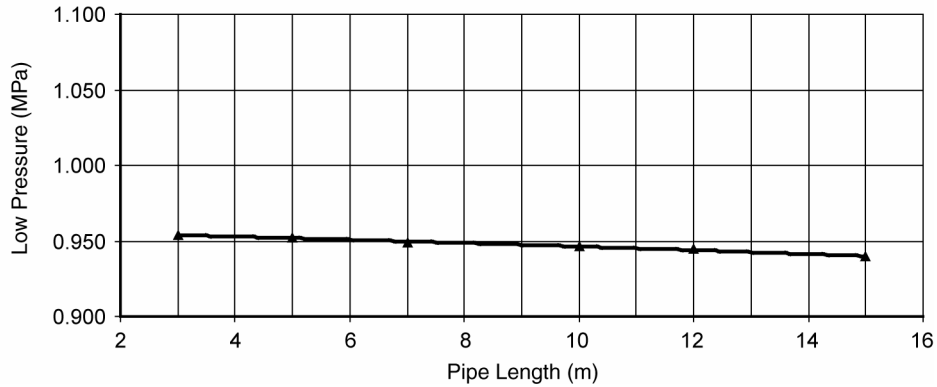
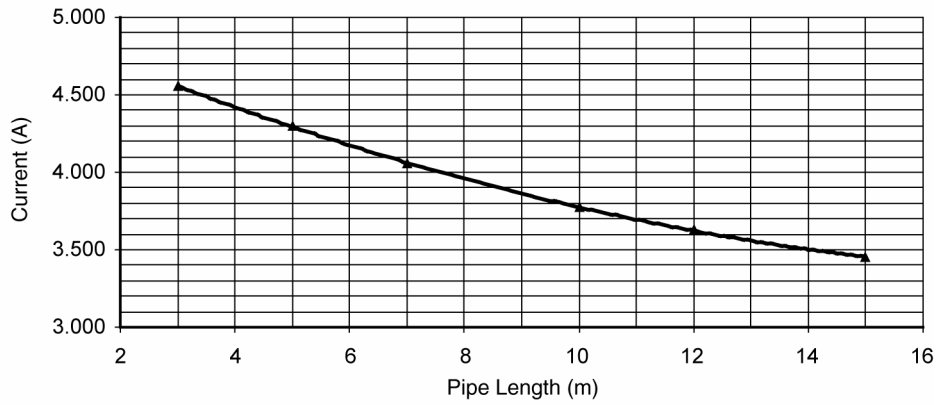
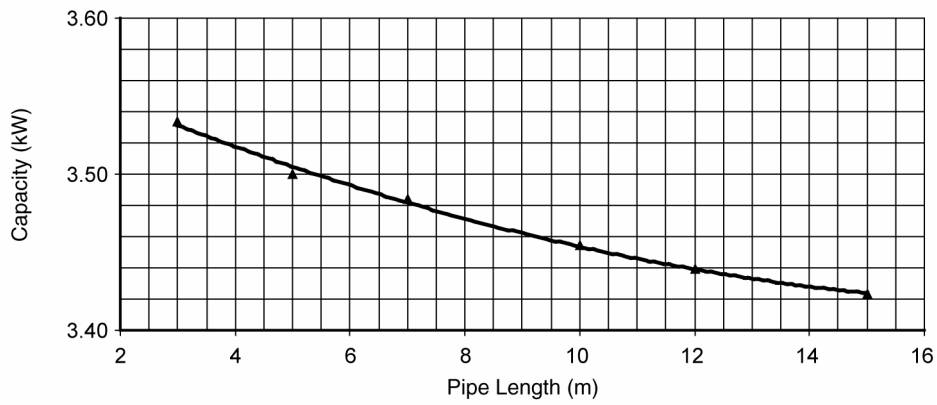
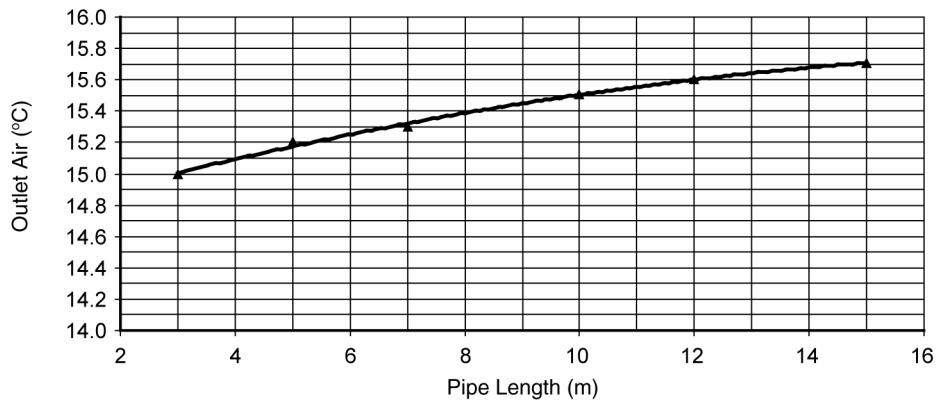

• Heating Characteristic

[Condition] Indoor temperature: 20/-°C
 Remote condition: High fan speed, Heat 30°C
 Comp. Hz: Rated F_h
 Voltage: 230V

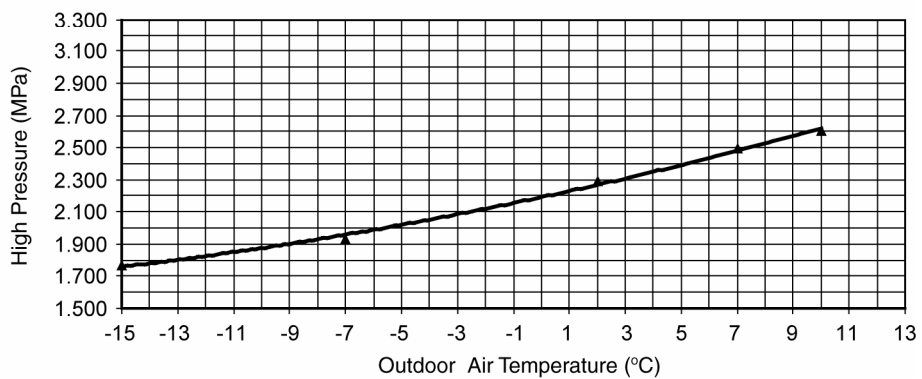
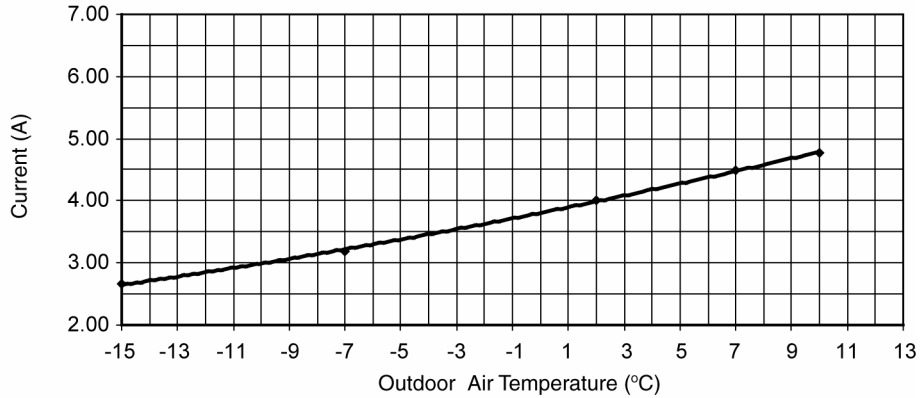
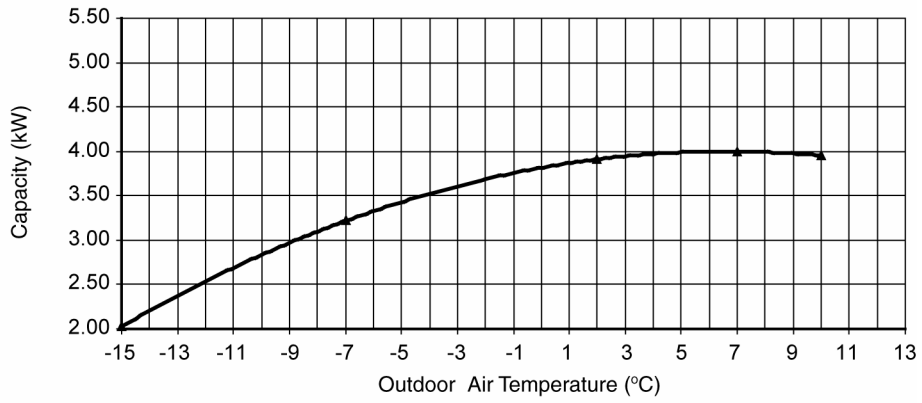
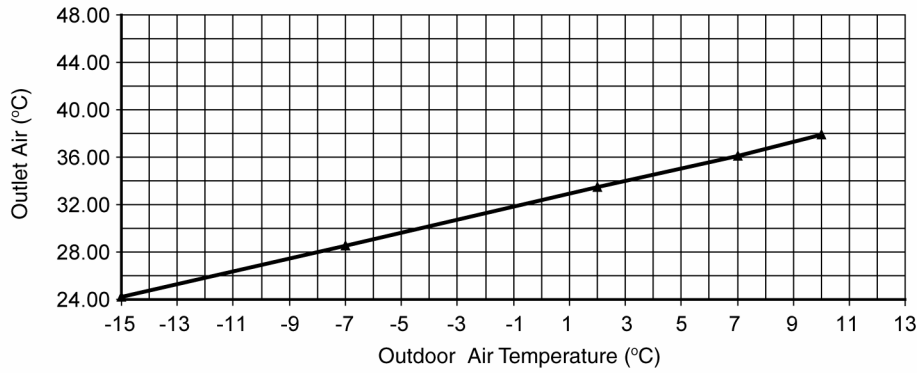

• Piping Length Characteristic

[Condition] Indoor temperature: 20/-°C, 7/6°C
 Remote condition: High fan speed, Heat 30°C
 Comp. Hz: Rated F_h
 Voltage: 230V

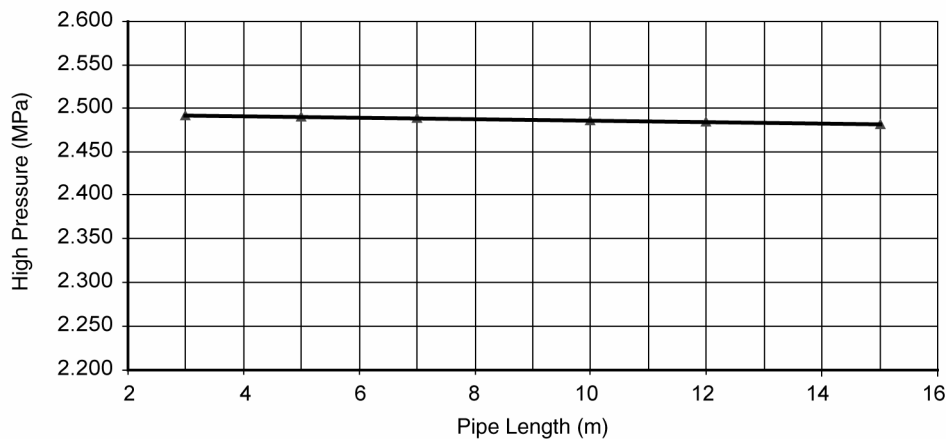
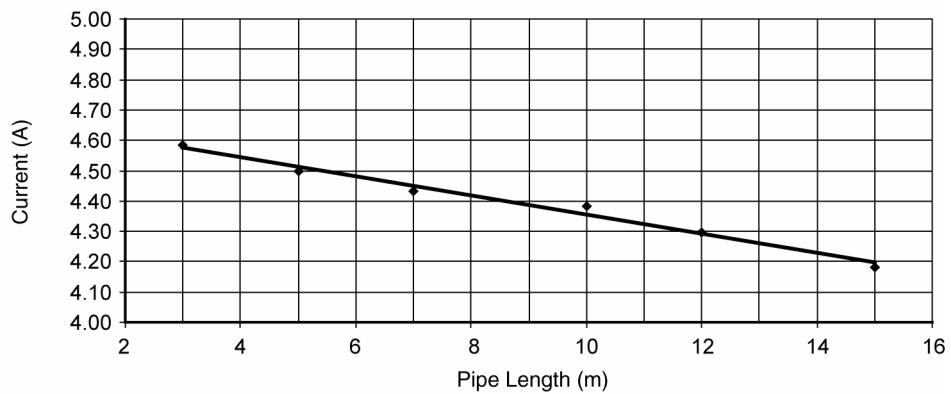
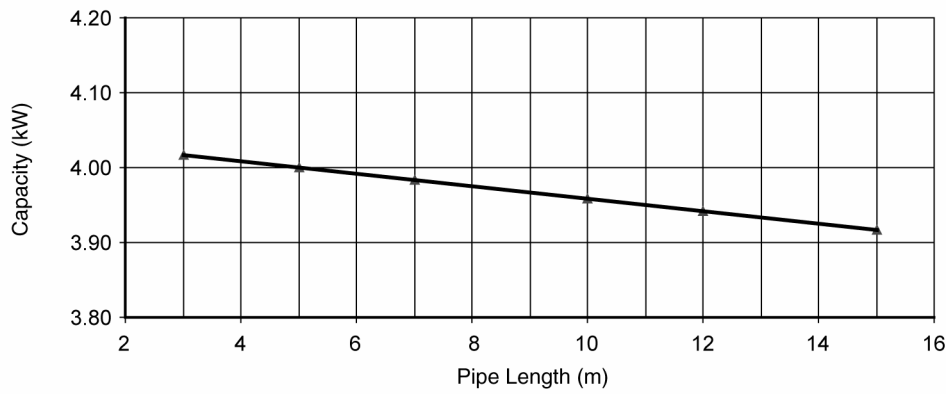
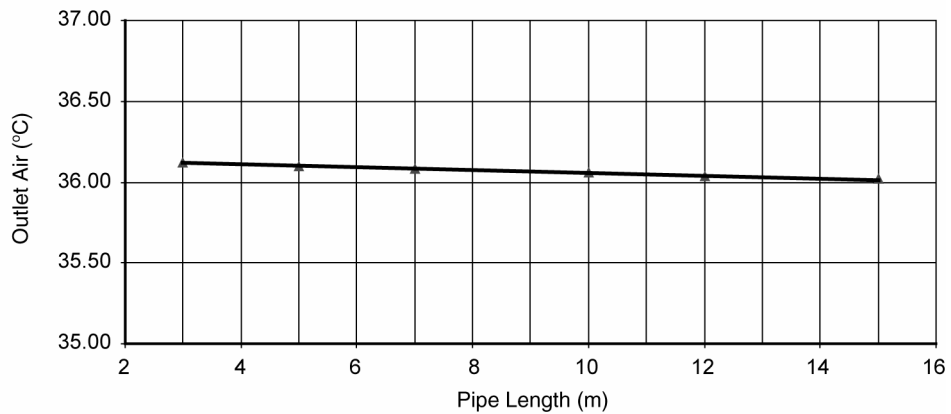

17.1.3 Sensible Capacity Chart

- **CU-QE9MKE**

220V	Outdoor Temp (°C)											
	30			35			40			46		
Indoor wet bulb temp.	TC	SHC	IP	TC	SHC	IP	TC	SHC	IP	TC	SHC	IP
17.0°C	2.48	1.88	0.49	2.32	1.80	0.53	2.16	1.73	0.57	1.96	1.65	0.61
19.0°C				2.50		0.54						
19.5°C	2.72	1.97	0.50	2.55	1.89	0.54	2.37	1.82	0.58	2.15	1.73	0.63
22.0°C	2.97	2.04	0.51	2.77	1.96	0.55	2.58	1.89	0.59	2.35	1.81	0.64

- **CU-QE12MKE**

220V	Outdoor Temp (°C)											
	30			35			40			46		
Indoor wet bulb temp.	TC	SHC	IP	TC	SHC	IP	TC	SHC	IP	TC	SHC	IP
17.0°C	3.47	2.63	0.83	3.24	2.52	0.90	3.02	2.43	0.96	2.74	2.30	1.03
19.0°C				3.50		0.91						
19.5°C	3.81	2.76	0.85	3.56	2.65	0.91	3.31	2.55	0.98	3.01	2.43	1.05
22.0°C	4.15	2.86	0.86	3.88	2.75	0.93	3.61	2.65	0.99	3.28	2.53	1.07

TC - Total Cooling Capacity (kW)

SHC - Sensible Heat Capacity (kW)

IP - Input Power (kW)

Indoor 27°C /19°C

Outdoor 35°C /24°C

18. Exploded View and Replacement Parts List

18.1 Indoor Unit

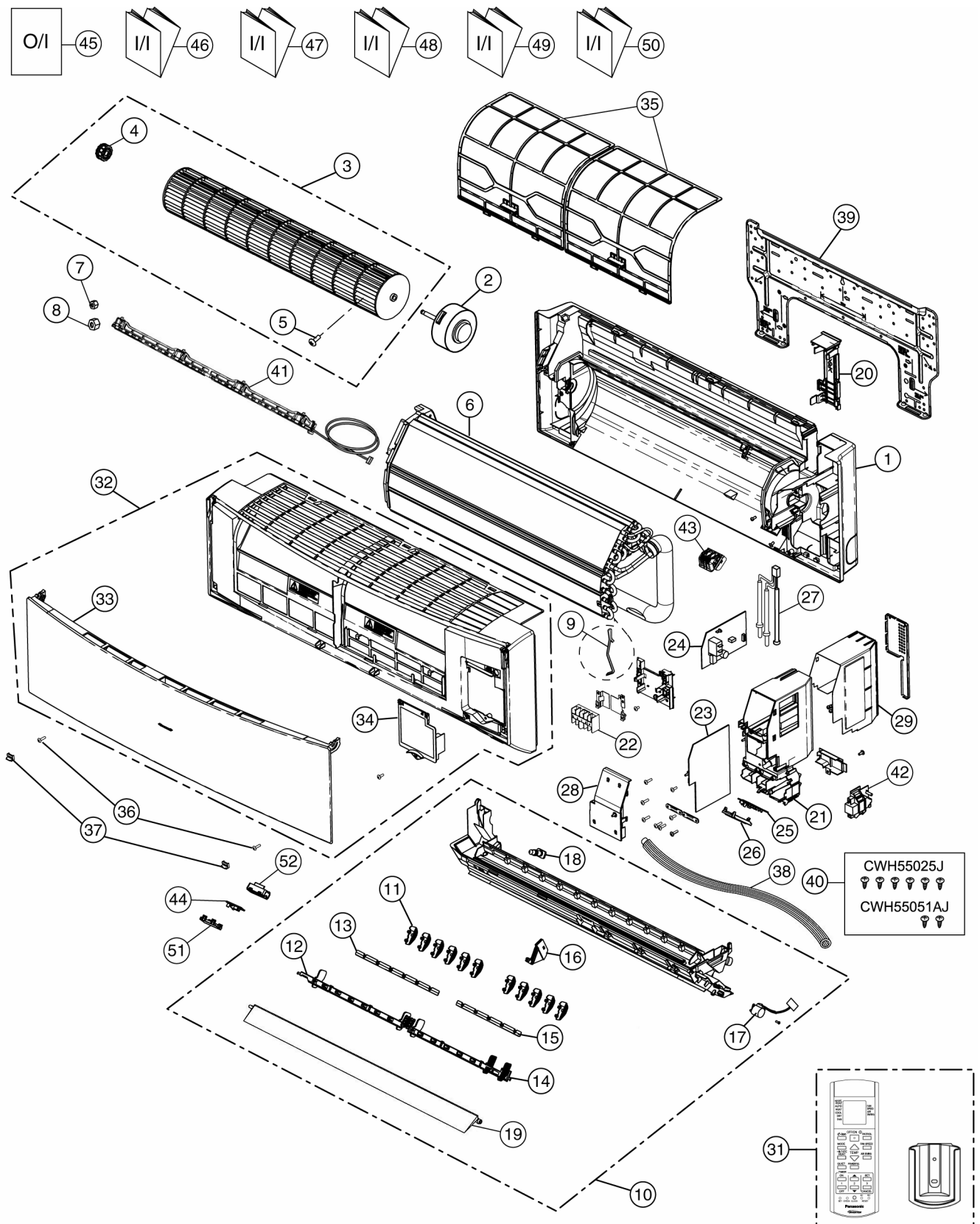

Note
 The above exploded view is for the purpose of parts disassembly and replacement.
 The non-numbered parts are not kept as standard service parts.

REF. NO.	PART NAME & DESCRIPTION	QTY.	CS-QE9MKE	CS-WE9MKE	CS-QE12MKE	CS-WE12MKE	REMARK
1	CHASSIS COMPLETE	1	CWD50C1599	CWD50C1605	CWD50C1599	CWD50C1605	
2	FAN MOTOR	1	ARW6101CB	←	←	←	O
3	CROSS FLOW FAN COMPLETE	1	CWH02C1076	←	←	←	
4	BEARING ASS'Y	1	CWH64K007	←	←	←	O
5	SCREW - CROSS FLOW FAN	1	CWH551146	←	←	←	
6	EVAPORATOR	1	CWB30C3074	←	CWB30C3323	←	
7	FLARE NUT (LIQUID)	1	CWT251030	←	←	←	
8	FLARE NUT (GAS)	1	CWT251031	←	←	←	
9	HOLDER SENSOR	2	CWH32143	←	←	←	
10	DISCHARGE GRILLE COMPLETE	1	CWE20C3137	CWE20C3247	CWE20C3137	CWE20C3247	
11	VERTICAL VANE	11	CWE241350	←	←	←	
12	CONNECTING BAR	1	CWE261152	←	←	←	
13	CONNECTING BAR	1	CWE261153	←	←	←	
14	CONNECTING BAR	1	CWE261154	←	←	←	
15	CONNECTING BAR	1	CWE261155	←	←	←	
16	FULCRUM	1	CWH621102	←	←	←	
17	A.S.MOTOR, DC SINGLE 12V 300 OHM	1	CWA981264	←	←	←	O
18	CAP - DRAIN TRAY	1	CWH521096	←	←	←	
19	HORIZONTAL VANE	1	CWE24C1268	CWE24C1288	CWE24C1268	CWE24C1288	
20	BACK COVER CHASSIS	1	CWD933233	CWD933233A	CWD933233	CWD933233A	
21	CONTROL BOARD CASING	1	CWH102370	←	←	←	
22	TERMINAL BOARD COMPLETE	1	CWA28C2357	←	←	←	O
23	ELECTRONIC CONTROLLER - MAIN	1	CWA73C5750	←	CWA73C5751	←	O
24	ELECTRONIC CONTROLLER - POWER	1	CWA745837	←	←	←	O
25	ELECTRONIC CONTROLLER - INDICATOR	1	CWA745995	←	←	←	O
26	INDICATOR HOLDER	1	CWD933021	←	←	←	
27	SENSOR COMPLETE	1	CWA50C2664	←	←	←	O
28	CONTROL BOARD FRONT COVER	1	CWH13C1183	←	←	←	
29	CONTROL BOARD TOP COVER	1	CWH131350	←	←	←	
31	REMOTE CONTROL COMPLETE	1	CWA75C3634	←	←	←	O
32	FRONT GRILLE COMPLETE	1	CWE11C4579	CWE11C4581	CWE11C4579	CWE11C4581	O
33	INTAKE GRILLE COMPLETE	1	CWE22C1507	CWE22C1482	CWE22C1507	CWE22C1482	
34	GRILLE DOOR	1	CWE14C1029	CWE14C1038	CWE14C1029	CWE14C1038	
35	E-ION FILTER	2	CWD00K1016	←	←	←	O
36	SCREW - FRONT GRILLE	2	XTT4+16CFJ	←	←	←	
37	CAP - FRONT GRILLE	2	CWH521194	CWH521194A	CWH521194	CWH521194A	
38	DRAIN HOSE	1	CWH851173	←	←	←	
39	INSTALLATION PLATE	1	CWH361097	←	←	←	
40	BAG COMPLETE - INSTALLATION SCREW	1	CWH82C1705	←	←	←	
41	E-ION AIR PURIFYING SYSTEM	1	CWD93C1090	←	←	←	O
42	ELECTRONIC CONTROLLER-HVU	1	CWA745348	←	←	←	O
43	ION GENERATOR	1	CWH94C0028	←	←	←	O
44	ELECTRONIC CONTROLLER - RECEIVER	1	CWA745288	←	←	←	O
45	OPERATING INSTRUCTION	1	CWF568115	←	←	←	
46	INSTALLATION INSTRUCTION	1	CWF614902	←	←	←	
47	INSTALLATION INSTRUCTION	1	CWF614903	←	←	←	
48	INSTALLATION INSTRUCTION	1	CWF614904	←	←	←	
49	INSTALLATION INSTRUCTION	1	CWF614905	←	←	←	
50	INSTALLATION INSTRUCTION	1	CWF614906	←	←	←	

51	COVER FOR RECEIVER (UPPER)	1	CWD933022	←	←	←	
52	COVER FOR RECEIVER (BOTTOM)	1	CWD933209	←	←	←	

(Note)

- All parts are supplied from PHAAM, Malaysia (Vendor Code: 00029488).
“O” marked parts are recommended to be kept in stock.

18.2 Outdoor Unit

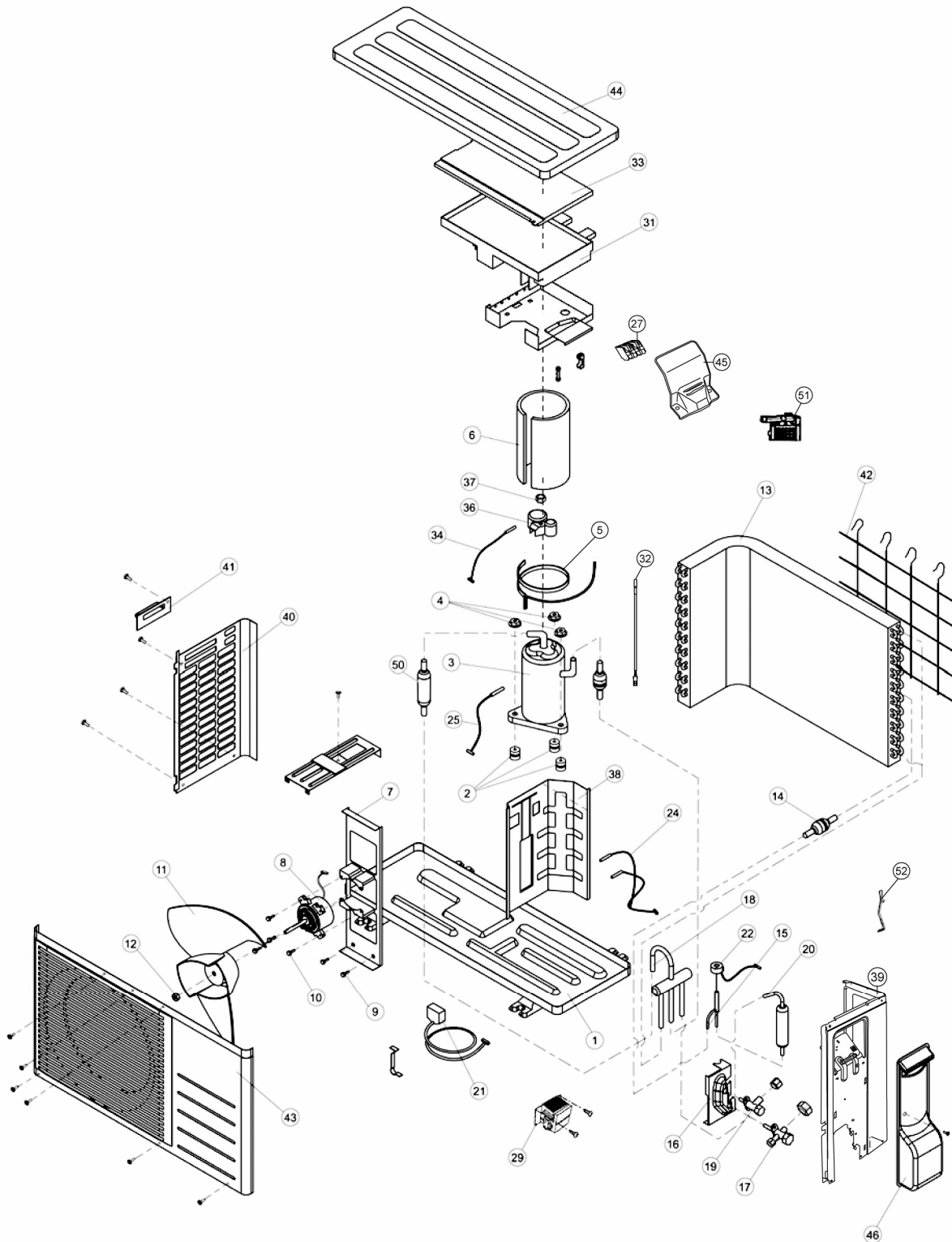

Note

The above exploded view is for the purpose of parts disassembly and replacement.
The non-numbered parts are not kept as standard service parts.

REF. NO.	DESCRIPTION & NAME	QTY.	CU-QE9MKE	CU-QE12MKE	REMARK
1	CHASSIS ASS'Y	1	CWD50K2202	←	
2	ANTI-VIBRATION BUSHING	3	CWH50077	←	
3	COMPRESSOR	1	5CS110XBD04	←	O
4	NUT-COMPRESSOR MOUNT	3	CWH56000J	←	
5	CRANKCASE HEATER	1	CWA341072	←	
6	SOUND PROOF MATERIAL	1	CWG302466	←	
7	FAN MOTOR BRACKET	1	CWD541089	←	
8	FAN MOTOR	1	ARW44W8P40AC	←	O
9	SCREW - FAN MOTOR BRACKET	2	CWH551217	←	
10	SCREW - FAN MOTOR MOUNT	4	CWH55252J	←	
11	PROPELLER FAN ASSY	1	CWH03K1014	←	
12	NUT - PROPELLER FAN	1	CWH56053J	←	
13	CONDENSER COMPLETE	1	CWB32C2874	←	
14	STRAINER	1	CWB111004	←	
15	EXPANSION VALVE	1	CWB051016J	←	
16	HOLDER - COUPLING	1	CWH351025	←	
17	3 WAYS VALVE (GAS)	1	CWB011434	←	O
18	4-WAYS VALVE	1	CWB001037J	←	O
19	2 WAYS VALVE (LIQUID)	1	CWB021333	←	O
20	DISCHARGE MUFFLER	1	CWB121021	←	
21	V-COIL COMPLETE	1	CWA43C2144J	←	O
22	V-COIL COMPLETE	1	CWA43C2058J	←	O
24	SENSOR COMPLETE	1	CWA50C2402	←	O
25	SENSOR CO. OUTDOOR DISCHRG TEMP	1	CWA50C2512	←	O
27	TERMINAL BOARD ASSY	1	CWA28K1110J	←	O
29	REACTOR	1	G0C193J00003	←	O
31	ELECTRONIC CONTROLLER - MAIN	1	CWA73C5754R	CWA73C5755R	O
32	CRANKCASE HEATER	1	CWA341050	←	
33	CONTROL BOARD COVER (TOP)	1	CWH131264	←	
34	SENSOR CO.(OUTDOOR COMPRESSOR TEMP)	1	CWA50C2205	←	O
36	TERMINAL COVER	1	CWH171039A	←	
37	NUT-TERMINAL COVER	1	CWH7080300J	←	
38	SOUND PROOF BOARD	1	CWH151188	←	
39	CABINET SIDE PLATE (R)	1	CWE04C1212	←	
40	CABINET SIDE PLATE (L)	1	CWE041278A	←	
41	HANDLE	1	CWE161010	←	
42	WIRE NET	1	CWD041111A	←	
43	CABINET FRONT PLATE CO.	1	CWE06C1136	←	
44	CABINET TOP PLATE	1	CWE031014A	←	
45	PLATE-C.B.COVER	1	CWH131301	←	
46	CONTROL BOARD COVER COMPLETE	1	CWH13C1211	←	
50	RECEIVER	1	CWB14011	←	
51	HOLDER SENSOR	1	CWH321023	←	
52	HOLDER SENSOR	2	CWH32143	←	

(Note)

- All parts are supplied from PHAAM, Malaysia (Vendor Code: 00029488).
- “O” marked parts are recommended to be kept in stock.