

# Service Manual

## Air Conditioner

**CS-E9GKEW-5 CU-E9GKE-5**  
**CS-E12GKEW-5 CU-E12GKE-5**

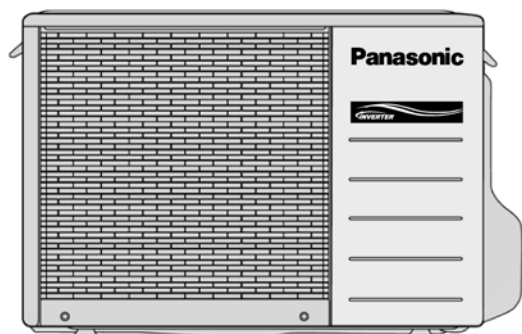

### ⚠ WARNING

This service information is designed for experienced repair technicians only and is not designed for use by the general public. It does not contain warnings or cautions to advise non-technical individuals of potential dangers in attempting to service a product. Products powered by electricity should be serviced or repaired only by experienced professional technicians. Any attempt to service or repair the product or products dealt with in this service information by anyone else could result in serious injury or death.

### ⚠ PRECAUTION OF LOW TEMPERATURE

In order to avoid frostbite, be assured of no refrigerant leakage during the installation or repairing of refrigeration circuit.

## TABLE OF CONTENTS

	PAGE		PAGE
<b>1 Safety Precaution</b> .....	<b>2</b>	9.2. Outdoor Unit .....	17
<b>2 Specifications</b> .....	<b>4</b>	<b>10 Printed Circuit Board</b> .....	<b>18</b>
2.1. CS-E9GKEW-5 CU-E9GKE-5 .....	4	10.1. Indoor Unit .....	18
2.2. CS-E12GKEW-5 CU-E12GKE-5 .....	6	10.2. Outdoor Unit .....	20
<b>3 Features</b> .....	<b>8</b>	<b>11 Installation Instruction</b> .....	<b>21</b>
<b>4 Location of Controls and Components</b> .....	<b>9</b>	11.1. Select The Best Location .....	21
4.1. Product Overview .....	9	11.2. Indoor/Outdoor Unit Installation Diagram .....	21
<b>5 Dimensions</b> .....	<b>10</b>	11.3. Indoor Unit .....	22
5.1. Indoor Unit .....	10	11.4. Outdoor Unit .....	25
5.2. Outdoor Unit .....	11	<b>12 Operation and Control</b> .....	<b>28</b>
<b>6 Refrigeration Cycle Diagram</b> .....	<b>12</b>	12.1. Basic Function .....	28
<b>7 Block Diagram</b> .....	<b>13</b>	12.2. Protection Control .....	38
<b>8 Wiring Connection Diagram</b> .....	<b>14</b>	<b>13 Servicing Mode</b> .....	<b>42</b>
8.1. Indoor Unit .....	14	13.1. Auto OFF/ON Button .....	42
8.2. Outdoor Unit .....	15	13.2. Select Remote Control Transmission Code .....	42
<b>9 Electronic Circuit Diagram</b> .....	<b>16</b>	13.3. Remote Control Button .....	43
9.1. Indoor Unit .....	16	<b>14 Troubleshooting Guide</b> .....	<b>44</b>

# Panasonic®

© 2006 Panasonic HA Air-Conditioning (M) Sdn. Bhd. (11969-T). All rights reserved. Unauthorized copying and distribution is a violation of law.

14.1. Refrigeration Cycle System .....	44
14.2. Breakdown Self Diagnosis Function .....	46
14.3. Error Codes Table.....	47
<b>15 Disassembly and Assembly Instructions.....</b>	<b>48</b>
15.1. Indoor Electronic Controllers, Cross Flow Fan and Indoor Fan Motor Removal Procedures .....	48
15.2. Outdoor Electronic Controller Removal Procedure .....	52

<b>16 Technical Data .....</b>	<b>53</b>
16.1. Operation Characteristics .....	53
16.2. Sensible Capacity Chart .....	61
<b>17 Exploded View and Replacement Parts List.....</b>	<b>62</b>
17.1. Indoor Unit.....	62
17.2. Outdoor Unit .....	64

# 1 Safety Precaution

- Read the following “SAFETY PRECAUTIONS” carefully before perform any servicing.
- Electrical work must be installed or serviced by a licensed electrician. Be sure to use the correct rating of the power plug and main circuit for the model installed.
- The caution items stated here must be followed because these important contents are related to safety. The meaning of each indication used is as below. Incorrect installation or servicing due to ignoring of the instruction will cause harm or damage, and the seriousness is classified by the following indications.





 <b>WARNING</b>	This indication shows the possibility of causing death or serious injury.
--	---

 <b>CAUTION</b>	This indication shows the possibility of causing injury or damage to properties.
--	--

- The items to be followed are classified by the symbols:

	This symbol denotes item that is PROHIBITED from doing.
---	---

- Carry out test running to confirm that no abnormality occurs after the servicing. Then, explain to user the operation, care and maintenance as stated in instructions. Please remind the customer to keep the operating instructions for future reference.

 <b>WARNING</b>	
1. Engage dealer or specialist for installation and servicing. If installation or servicing done by the user is defective, it will cause water leakage, electrical shock or fire.	
2. Install according to this installation instruction strictly. If installation is defective, it will cause water leakage, electrical shock or fire.	
3. Use the attached accessories parts and specified parts for installation and servicing. Otherwise, it will cause the set to fall, water leakage, fire or electrical shock.	
4. Install at a strong and firm location which is able to withstand the set's weight. If the strength is not enough or installation is not properly done, the set will drop and cause injury.	
5. For electrical work, follow the local national wiring standard, regulation and the installation instruction. An independent circuit and single outlet must be used. If electrical circuit capacity is not enough or defect found in electrical work, it will cause electrical shock or fire.	
6. Use the specified cable and connect tightly for indoor/outdoor connection. Connect tightly and clamp the cable so that no external force will be acted on the terminal. If connection or fixing is not perfect, it will cause heat-up or fire at the connection.	
7. Wire routing must be properly arranged so that control board cover is fixed properly. If control board cover is not fixed perfectly, it will cause heat-up at connection point of terminal, fire or electrical shock.	
8. When connecting the piping, do not allow air or any substances other than the specified refrigerant to enter the refrigeration cycle. Otherwise, this may lower the capacity, cause abnormally high pressure in the refrigeration cycle, and possibly result in explosion and injury.	
9. Thickness of copper pipes used must be more than 0.8 mm. Never use copper pipes thinner than 0.8 mm.	
10. It is desirable that the amount of residual oil is less than 40 mg/10 m.	
11. Do not modify the length of the power supply cord or use of the extension cord, and do not share the single outlet with other electrical appliances. Otherwise, it will cause fire or electrical shock.	

## CAUTION

1. The equipment must be earthed. It may cause electrical shock if grounding is not perfect.
2. Do not install the unit at place where leakage of flammable gas may occur. In case gas leaks and accumulates at surrounding of the unit, it may cause fire. 
3. Carry out drainage piping as mentioned in installation instructions. If drainage is not perfect, water may enter the room and damage the furniture.
4. Pb free solder has a higher melting point than standard solder; typically the melting point is 50 - 70°F (30 - 40°C) higher. Please use a high temperature soldering iron. In case of the soldering iron with temperature control, please set it to 700 ± 20°F (370 ± 10°C). Pb free solder will tend to splash when heated too high (about 1100°F/600°C).

## ATTENTION

1. Selection of the installation location. Select an installation location which is rigid and strong enough to support or hold the unit, and select a location for easy maintenance.
2. Power supply connection to the conditioner. Connect the power supply cord of the air conditioner to the mains using one of the following methods.  
Power supply point shall be the place where there is ease for access for the power disconnection in case of emergency.  
In some countries, permanent connection of this room air conditioner to the power supply is prohibited.
  1. Power supply connection to the receptacle using a power plug. Use an approved power plug with earth pin for the connection to the socket.
  2. Power supply connection to a circuit breaker for the permanent connection. Use an approved circuit breaker for the permanent connection. It must be a double pole switch with a minimum 3.5 mm contact gap.
3. Do not release refrigerant during piping work for installation, servicing, reinstallation and during repairing a refrigeration parts. Take care of the liquid refrigerant, it may cause frostbite.
4. Installation work. It may need two people to carry out the installation work.
5. Do not install this appliance in a laundry room or other location where water may drip from the ceiling, etc.

## 2 Specifications

### 2.1. CS-E9GKEW-5 CU-E9GKE-5

ITEM		UNIT	INDOOR UNIT	OUTDOOR UNIT	
Performance Test Condition			EUROVENT		
C O O L I N G	Capacity	kW	2.60 (0.80 ~ 3.00)		
		kCal/h	2240 (690 ~ 2580)		
	EER	W/W	4.41 (4.57 ~ 4.00)		
		kCal/hW	3.80 (3.94 ~ 3.44)		
	Noise Level	dB (A)	High 39, Low 25	High 46	
Power level dB		50	59		
H E A T I N G	Capacity	kW	3.60 (0.80 ~ 5.00)		
		kCal/h	3100 (690 ~ 4300)		
	COP	W/W	4.31 (4.85 ~ 3.73)		
		kCal/hW	3.71 (4.18 ~ 3.21)		
	Noise Level	dB (A)	High 40, Low 27	High 47	
Power level dB		51	60		
Moisture Removal		l/h	1.6		
		pt/h	3.4		
Air Volume	Lo	m <sup>3</sup> /min (ft <sup>3</sup> /min)	Cooling; 6.6 (230) Heating; 7.1 (250)	—	
	Me	m <sup>3</sup> /min (ft <sup>3</sup> /min)	Cooling; 8.5 (300) Heating; 9.1 (320)	—	
	Hi	m <sup>3</sup> /min (ft <sup>3</sup> /min)	Cooling; 10.4 (370) Heating; 11.0 (390)	Cooling; 29.8 (1050)	
	SHi	m <sup>3</sup> /min (ft <sup>3</sup> /min)	Cooling; 10.7 (380) Heating; 11.4 (400)	—	
Refrigeration Control Device			—	Check Valve & Capillary Tube	
Refrigeration Oil		cm <sup>3</sup>	—	RB68A or Freol Alpha68M (320)	
Refrigerant (R410A)		g (oz)	—	965 (34.1)	
Dimension	Height	mm (inch)	280 (11-1/32)	540 (21-1/4)	
	Width	mm (inch)	799 (31-15/32)	780 (30-23/32)	
	Depth	mm (inch)	183 (7-7/32)	289 (11-3/8)	
Net Weight		kg (lbs)	9 (20)	34 (75)	
Pipe Diameter	Gas	mm (inch)	9.52 (3/8)		
	Liquid	mm (inch)	6.35 (1/4)		
Standard Length		m (ft)	7.5 (24.6)		
Pipe Length Range		m (ft)	3 (9.8) ~ 15 (49.2)		
Height Difference		m (ft)	15 (49.2)		
Additional Gas Amount		g/m (oz/ft)	20 (0.2)		
Refrigeration Charge Less		m (ft)	7.5 (24.6)		
Drain Hose	Inner Diameter	mm	16	—	
	Length	mm	650	—	
Compressor	Type		—	Hermetic Motor	
	Motor Type		—	Brushless (6-pole)	
	Rated Output	W	—	700	
Fan	Type		Cross-Flow Fan	Propeller Fan	
	Material		ASG20K1	PP	
	Motor Type		Transistor (8-pole)	Induction (6-pole)	
	Input Power	W	—	65	
	Output Power	W	30	25	
	Fan Speed	Lo (Cool/Heat)	rpm	830 / 900	—
		Me (Cool/Heat)	rpm	1070 / 1150	—
Hi (Cool/Heat)		rpm	1310 / 1400	770 / —	
SHi (Cool/Heat)		rpm	1350 / 1440	—	

ITEM		UNIT	INDOOR UNIT	OUTDOOR UNIT
Heat Exchanger	Fin Material		Aluminium (Pre Coat)	Aluminium
	Fin Type		Slit Fin	Corrugated Fin
	Row x Stage x FPI		2 x 15 x 19	2 x 24 x 17
	Size (W x H x L)	mm	610 x 315 x 25.4	36.4 x 504 x 713 684
Air Filter	Material		Polypropelene	—
	Type		One-Touch	—

1. Cooling capacities are based on indoor temperature of 27°C D.B. (80.6°F D.B.), 19.0°C W.B. (66.2°F W.B.) and outdoor air temperature of 35°C D.B. (95°F D.B.), 24°C W.B. (75.2°F W.B.)
2. Heating capacities are based on indoor temperature of 20°C D.B. (68°F D.B.) and outdoor air temperature of 7°C D.B. (44.6°F D.B.), 6°C W.B. (42.8°F W.B.)

Item	Unit	
Power Source (Phase, Voltage, Cycle)	∅	Single
	V	230
	Hz	50
Input Power	W	Cooling; 590 (175 ~ 750) Heating; 835 (165 ~ 1340)
Starting Current	A	3.9
Running Current	A	Cooling; 2.8 Heating; 3.9
Power Factor	%	Cooling; 92 Heating; 93
Power factor means total figure of compressor, indoor fan motor and outdoor fan motor.		
*Maximum over current protection	A	5.9
Power Cord	Number of core	—
	Length	m
Thermostat		Electronic Control
Protection Device		Electronic Control

**Note**

- Specifications are subject to change without notice for further improvement.

## 2.2. CS-E12GKEW-5 CU-E12GKE-5

ITEM		UNIT	INDOOR UNIT	OUTDOOR UNIT	
Performance Test Condition		EUROVENT			
C O O L I N G	Capacity	kW	3.50 (0.80 ~ 4.00)		
		kCal/h	3010 (690 ~ 3440)		
	EER	W/W	3.83 (4.32 ~ 3.39)		
		kCal/hW	3.29 (3.73 ~ 2.92)		
	Noise Level	dB (A)	High 42, Low 28	High 48	
Power level dB		53	61		
H E A T I N G	Capacity	kW	4.80 (0.80 ~ 6.50)		
		kCal/h	4130 (690 ~ 5590)		
	COP	W/W	3.81 (4.57 ~ 3.44)		
		kCal/hW	3.28 (3.94 ~ 2.96)		
	Noise Level	dB (A)	High 42, Low 33	High 50	
Power level dB		53	63		
Moisture Removal		l/h	2.0		
		pt/h	4.2		
Air Volume	Lo	m <sup>3</sup> /min (ft <sup>3</sup> /min)	Cooling; 7.0 (250) Heating; 8.5 (300)	—	
	Me	m <sup>3</sup> /min (ft <sup>3</sup> /min)	Cooling; 9.1 (320) Heating; 10.1 (360)	—	
	Hi	m <sup>3</sup> /min (ft <sup>3</sup> /min)	Cooling; 11.2 (400) Heating; 11.7 (410)	Cooling; 31.0 (1090)	
	SHi	m <sup>3</sup> /min (ft <sup>3</sup> /min)	Cooling; 11.5 (410) Heating; 12.1 (430)	—	
Refrigeration Control Device			—	Check Valve & Capillary Tube	
Refrigeration Oil		cm <sup>3</sup>	—	RB68A or Freol Alpha68M (320)	
Refrigerant (R410A)		g (oz)	—	980 (34.6)	
Dimension	Height	mm (inch)	280 (11-1/32)	540 (21-1/4)	
	Width	mm (inch)	799 (31-15/32)	780 (30-23/32)	
	Depth	mm (inch)	183 (7-7/32)	289 (11-3/8)	
Net Weight		kg (lbs)	9 (20)	35 (77)	
Pipe Diameter	Gas	mm (inch)	12.7 (1/2)		
	Liquid	mm (inch)	6.35 (1/4)		
Standard Length		m (ft)	7.5 (24.6)		
Pipe Length Range		m (ft)	3 (9.8) ~ 15 (49.2)		
Height Difference		m (ft)	15 (49.2)		
Additional Gas Amount		g/m (oz/ft)	20 (0.2)		
Refrigeration Charge Less		m (ft)	7.5 (24.6)		
Drain Hose	Inner Diameter	mm	16	—	
	Length	mm	650	—	
Compressor	Type		—	Hermetic Motor	
	Motor Type		—	Brushless (6-pole)	
	Rated Output	W	—	700	
Fan	Type		Cross-Flow Fan	Propeller Fan	
	Material		ASG20K1	PP	
	Motor Type		Transistor (8-pole)	Induction (6-pole)	
	Input Power	W	—	70	
	Output Power	W	30	30	
	Fan Speed	Lo (Cool/Heat)	rpm	900 / 1080	—
		Me (Cool/Heat)	rpm	1165 / 1290	—
		Hi (Cool/Heat)	rpm	1430 / 1500	830 / —
SHi (Cool/Heat)		rpm	1470 / 1540	—	

ITEM		UNIT	INDOOR UNIT	OUTDOOR UNIT
Heat Exchanger	Fin Material		Aluminium (Pre Coat)	Aluminium
	Fin Type		Slit Fin	Corrugated Fin
	Row x Stage x FPI		2 x 15 x 21	2 x 24 x 17
	Size (W x H x L)	mm	610 x 315 x 25.4	36.4 x 504 x 713 684
Air Filter	Material		Polypropelene	—
	Type		One-Touch	—

1. Cooling capacities are based on indoor temperature of 27°C D.B. (80.6°F D.B.), 19.0°C W.B. (66.2°F W.B.) and outdoor air temperature of 35°C D.B. (95°F D.B.), 24°C W.B. (75.2°F W.B.)

2. Heating capacities are based on indoor temperature of 20°C D.B. (68°F D.B.) and outdoor air temperature of 7°C D.B. (44.6°F D.B.), 6°C W.B. (42.8°F W.B.)

Item	Unit	
Power Source (Phase, Voltage, Cycle)	∅	Single
	V	230
	Hz	50
Input Power	W	Cooling; 915 (185 ~ 1180) Heating; 1260 (175 ~ 1890)
Starting Current	A	5.8
Running Current	A	Cooling; 4.2 Heating; 5.8
Power Factor	%	Cooling; 95 Heating; 95
Power factor means total figure of compressor, indoor fan motor and outdoor fan motor.		
*Maximum over current protection	A	8.7
Power Cord	Number of core	—
	Length	m
Thermostat		Electronic Control
Protection Device		Electronic Control

#### Note

- Specifications are subject to change without notice for further improvement.

## 3 Features

### • Product

- Four modes of operation selection
- Powerful mode to reach the desired room temperature quickly with full power and a strong airflow
- Quiet mode to provide a quiet environment by reducing the indoor unit operating airflow sound
- 24-hour ON Timer and OFF Timer setting
- Air swing manual and automatic adjusted by Remote Control for vertical airflow and the horizontal airflow direction louvers can be adjusted manually by hand
- Patrol sensor automatically detect the air quality. When the air quality is unsatisfactory, e-ion operation will start automatically.
- e-ion Air Purifying System provides clean air by producing negative ions to attract dust which will then be captured at the positively charged e-ion filters.

### • Serviceability Improvement

- Removable and washable Front Panel
- Breakdown Self Diagnosis function

### • Environmental Protection

- Non-ozone depletion substances refrigerant (R410A)

### • Operation Improvement

- Random auto restart control after power failure for safety restart operation
- Advanced inverter technology provides outstanding energy efficiency and powerful, flexible, comfortable operation



# 4 Location of Controls and Components

## 4.1. Product Overview

### 4.1.1. Indoor Unit

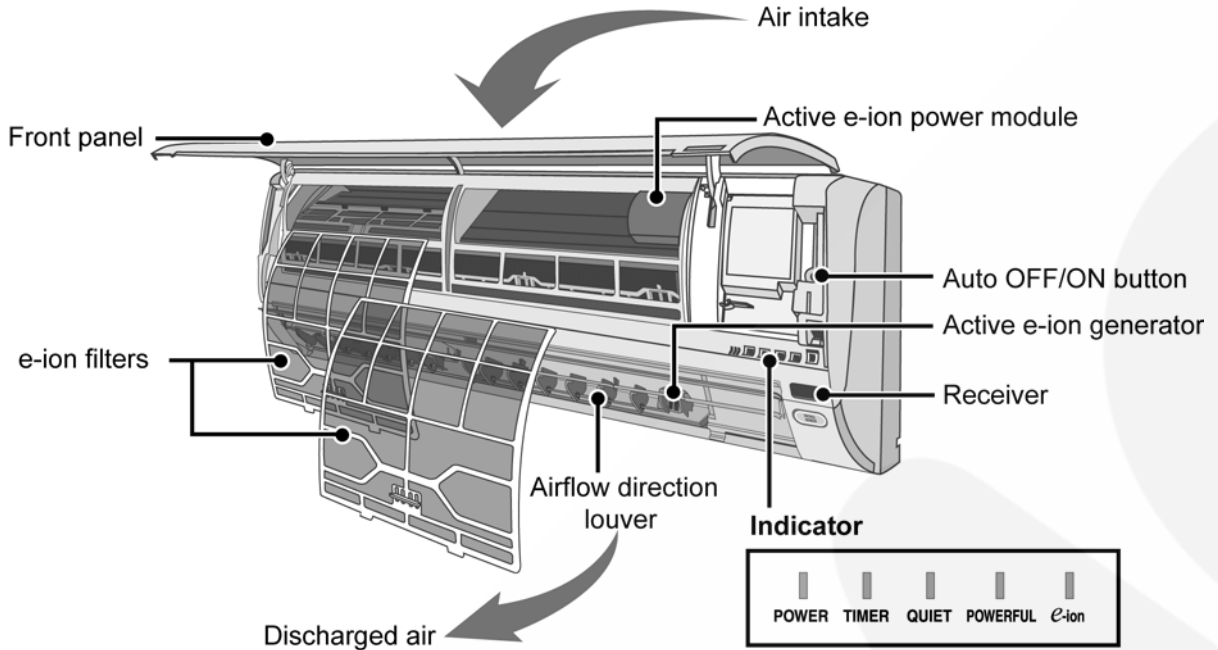

### 4.1.2. Outdoor Unit

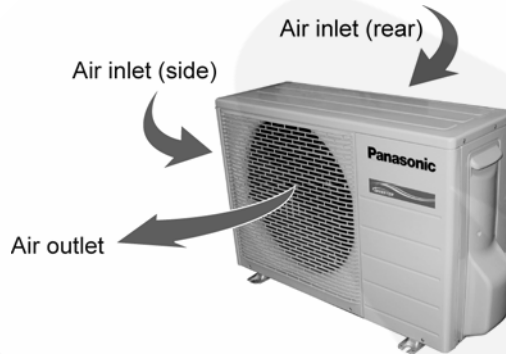

### 4.1.3. Remote Control

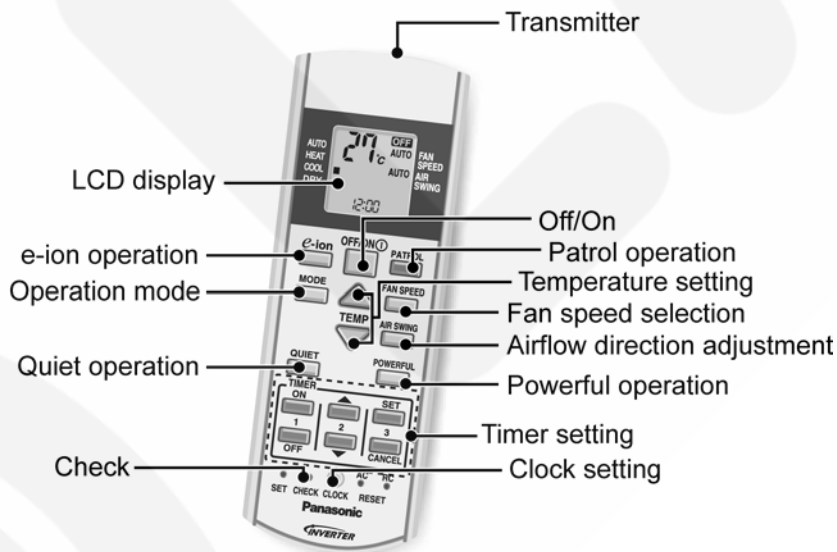

# 5 Dimensions

## 5.1. Indoor Unit

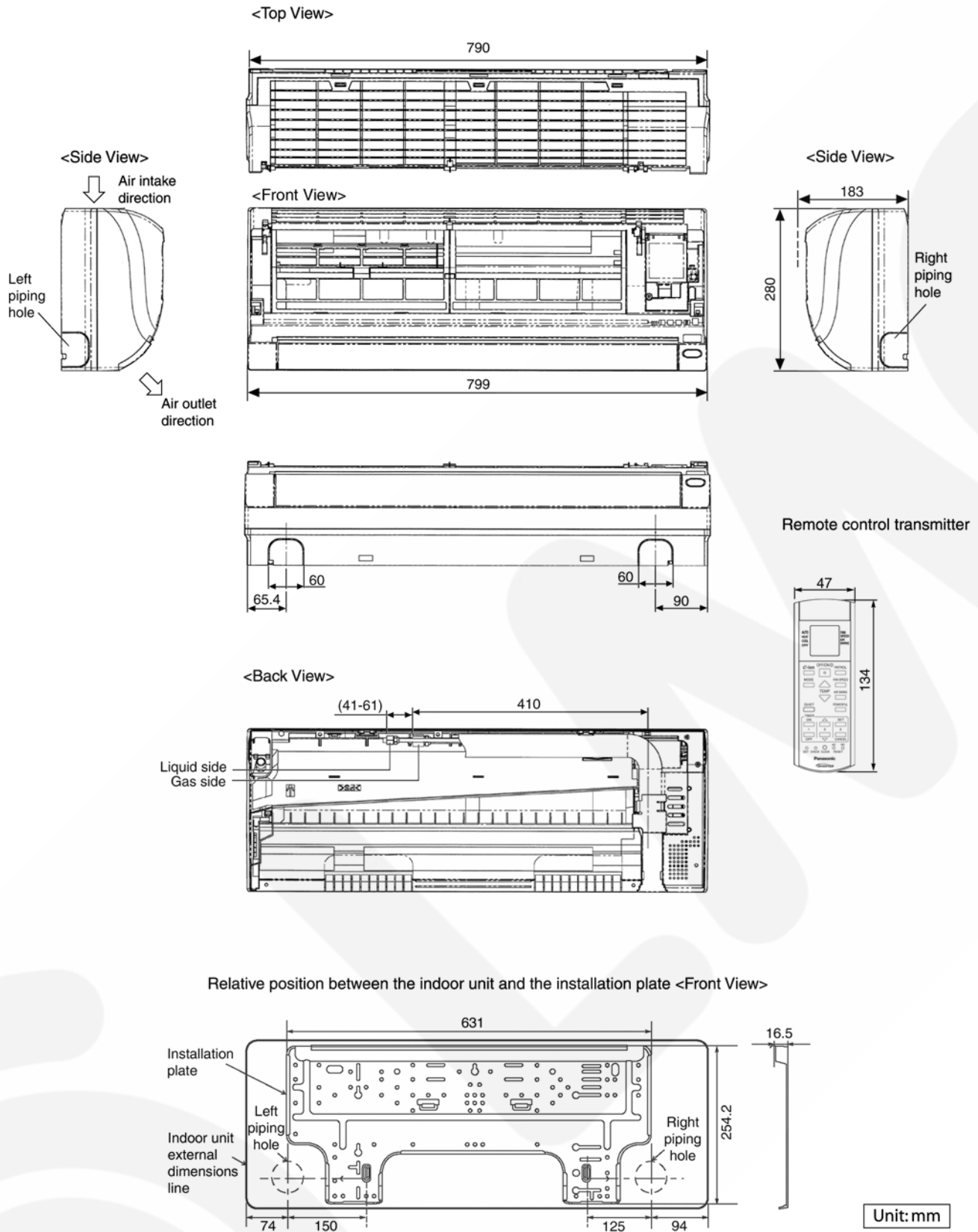

## 5.2. Outdoor Unit

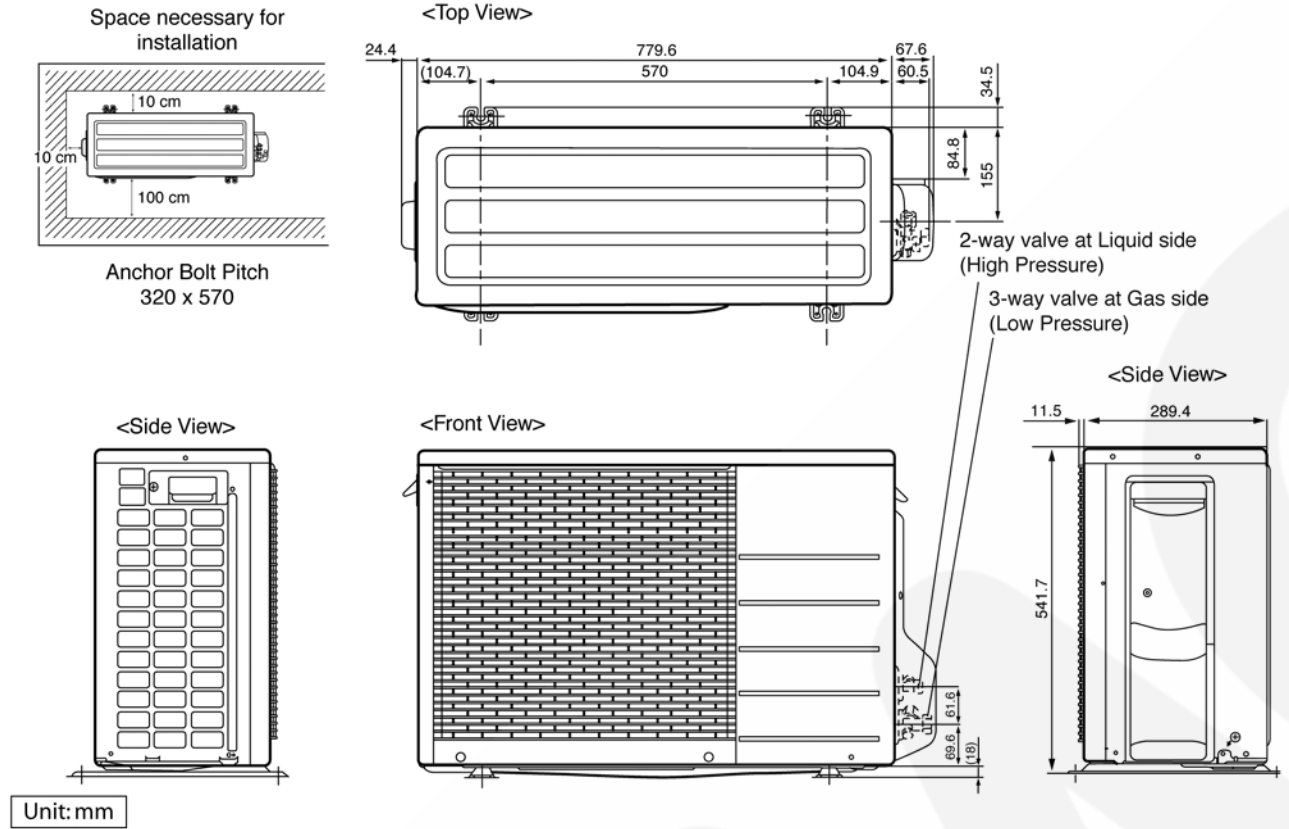

# 6 Refrigeration Cycle Diagram

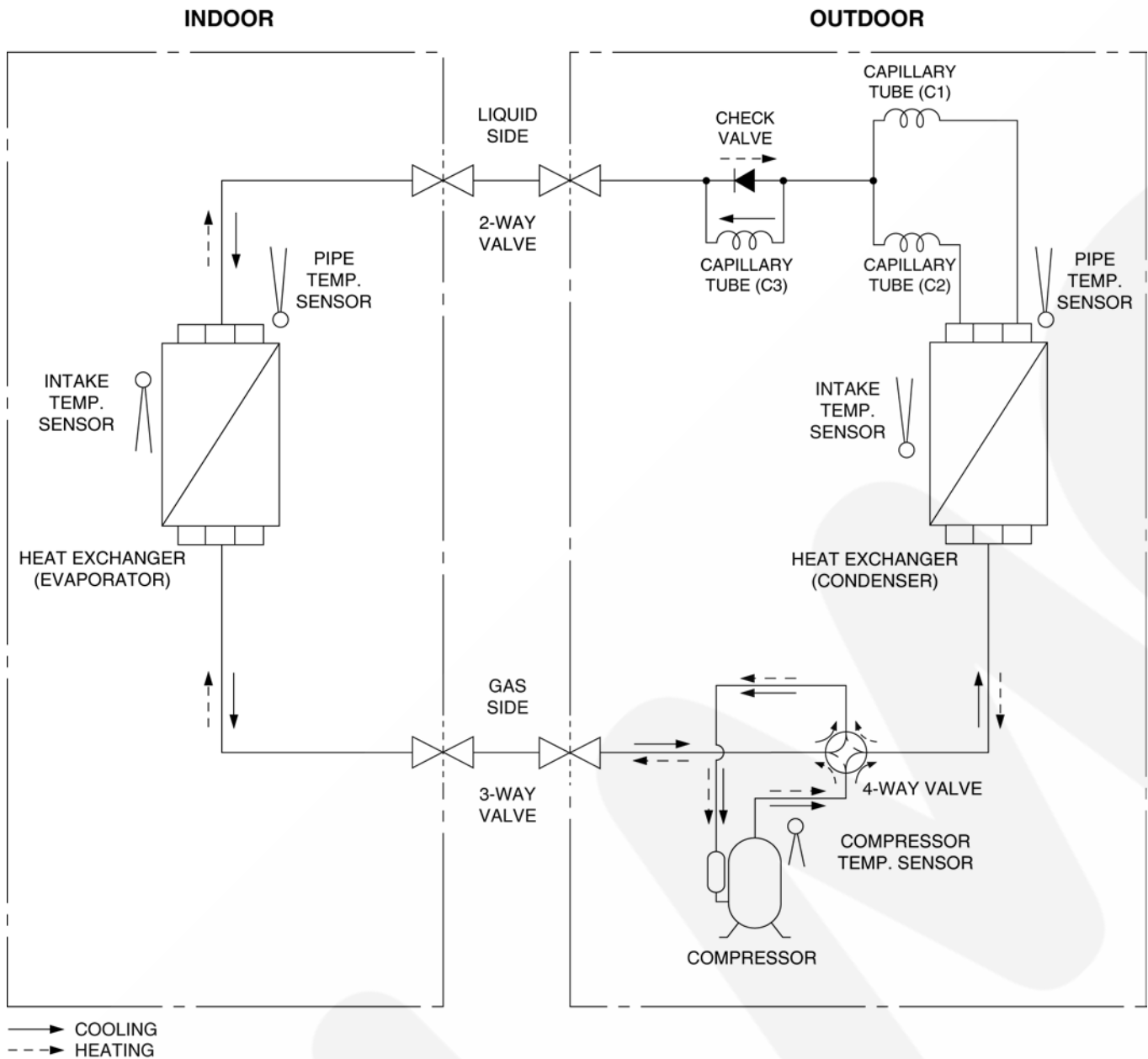

Model	Piping size		Rated Length (m)	Common Length (m)	Max. Elevation (m)	Max. Piping Length (m)	Additional Refrigerant (g/m)
	Gas	Liquid					
E9GK	3/8"	1/4"	7.5	7.5	15	15	20
E12GK	1/2"	1/4"	7.5	7.5	15	15	20

✘ If piping length is over common length, additional refrigerant should be added as shown in the table.

# 7 Block Diagram

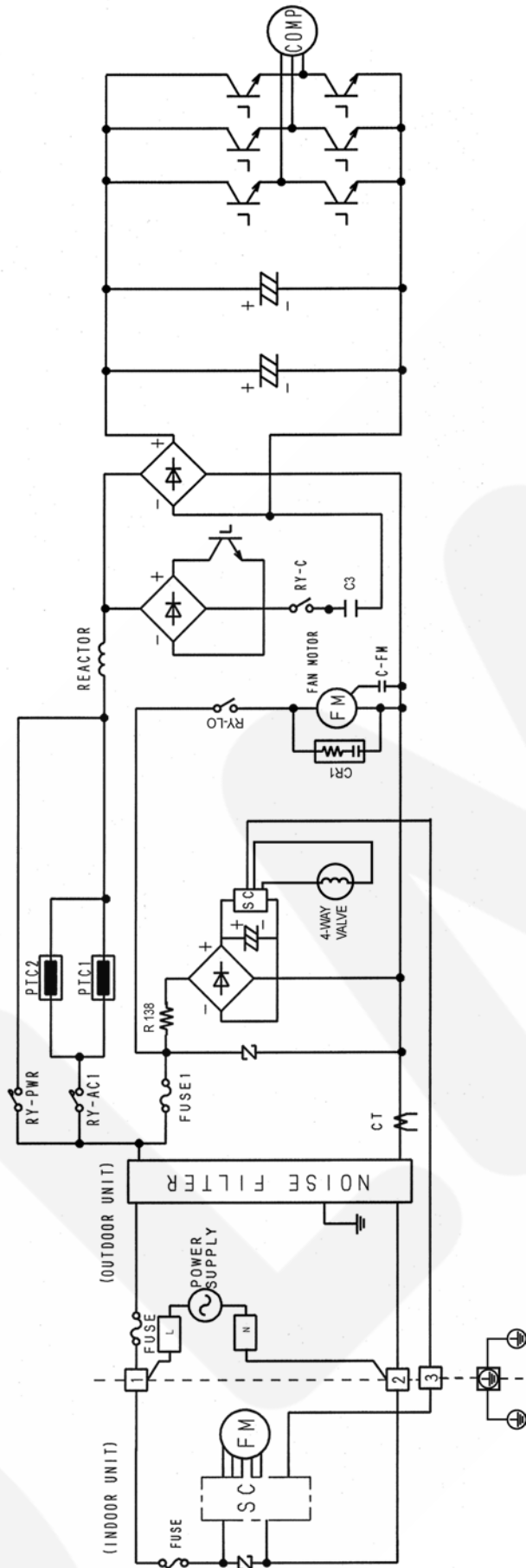

# 8 Wiring Connection Diagram

## 8.1. Indoor Unit

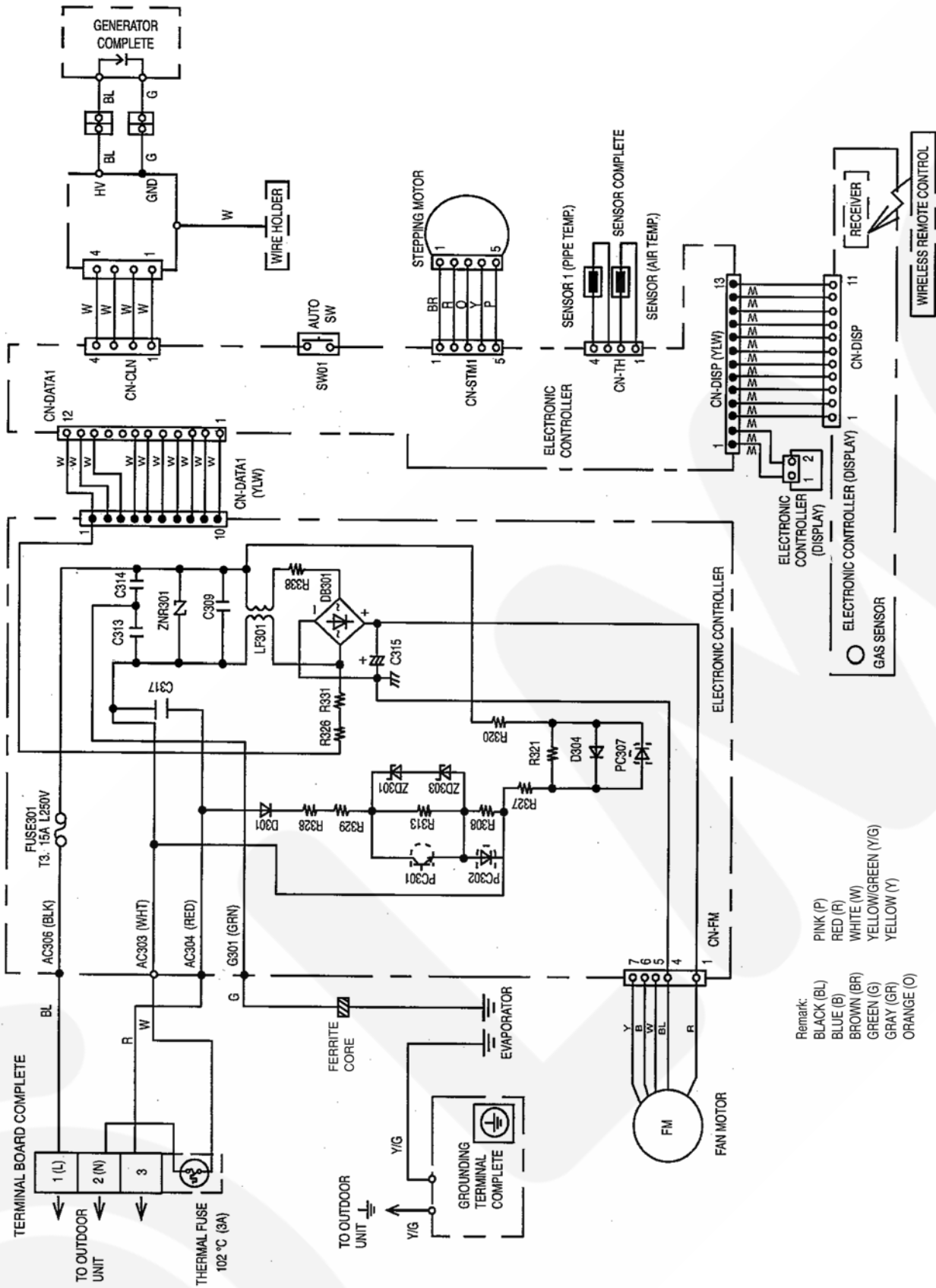

## 8.2. Outdoor Unit

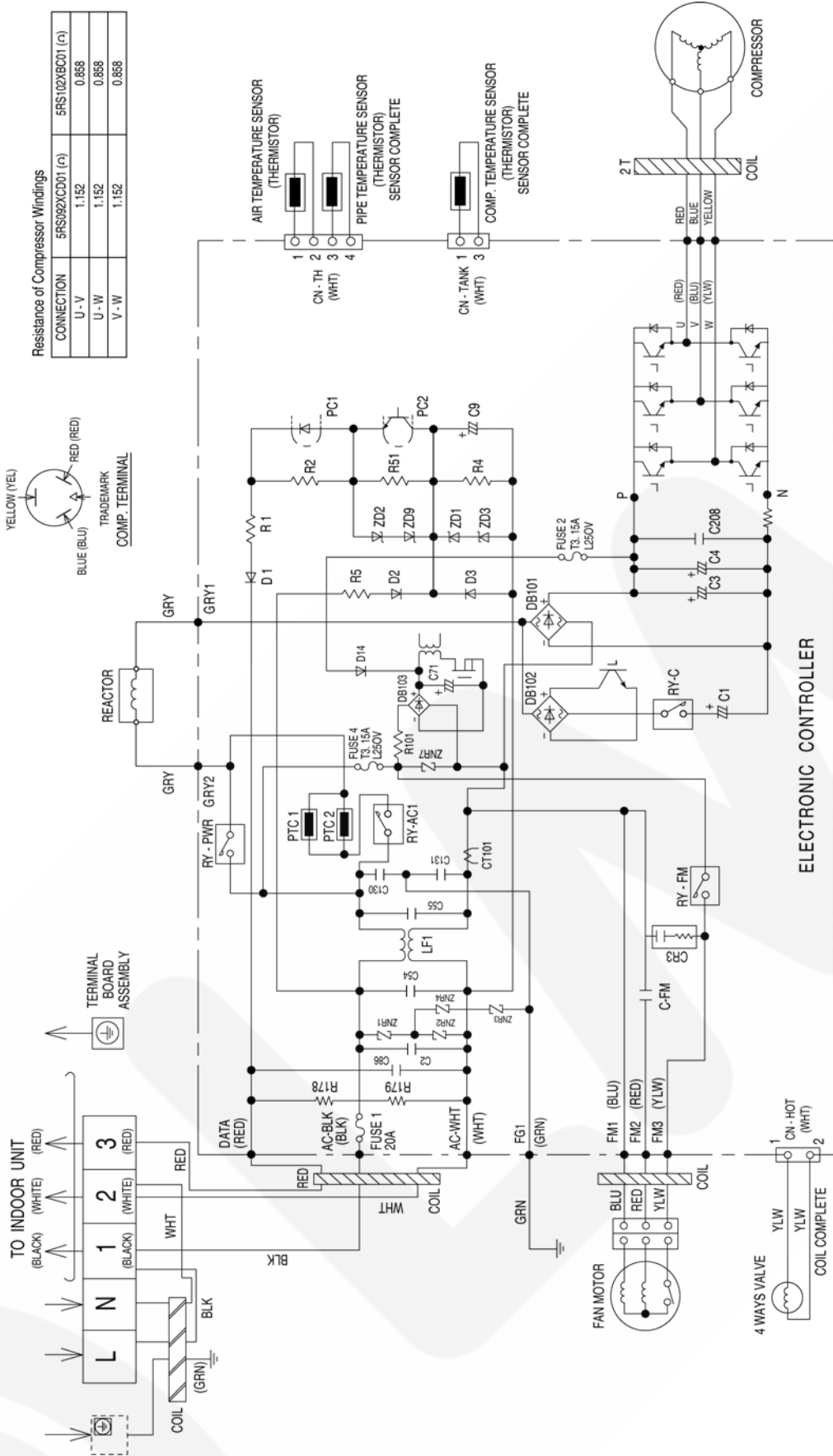

# 9 Electronic Circuit Diagram

## 9.1. Indoor Unit

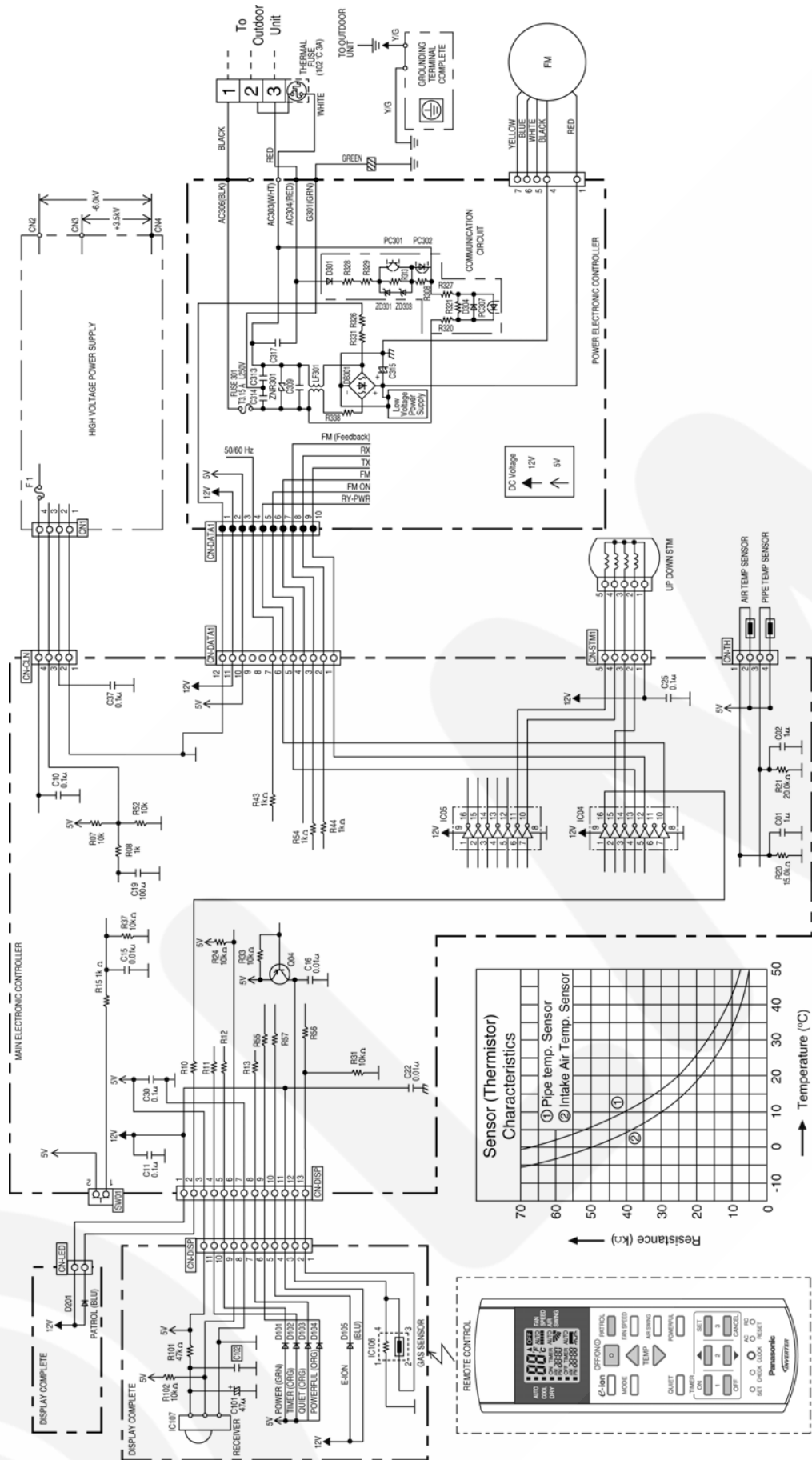



## 9.2. Outdoor Unit

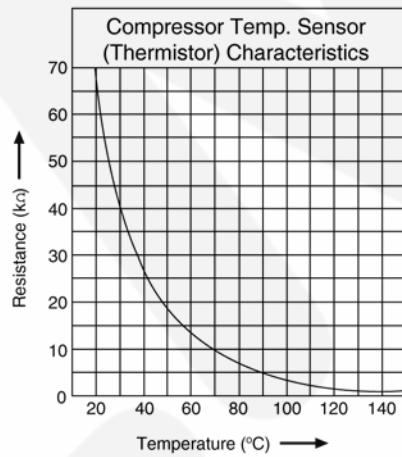
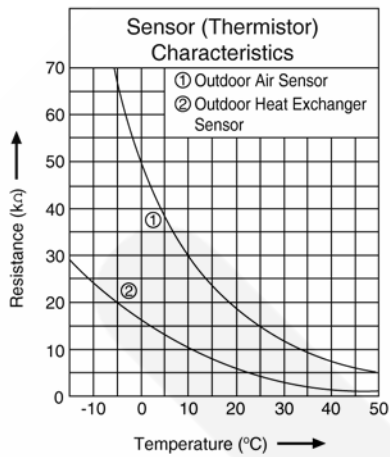
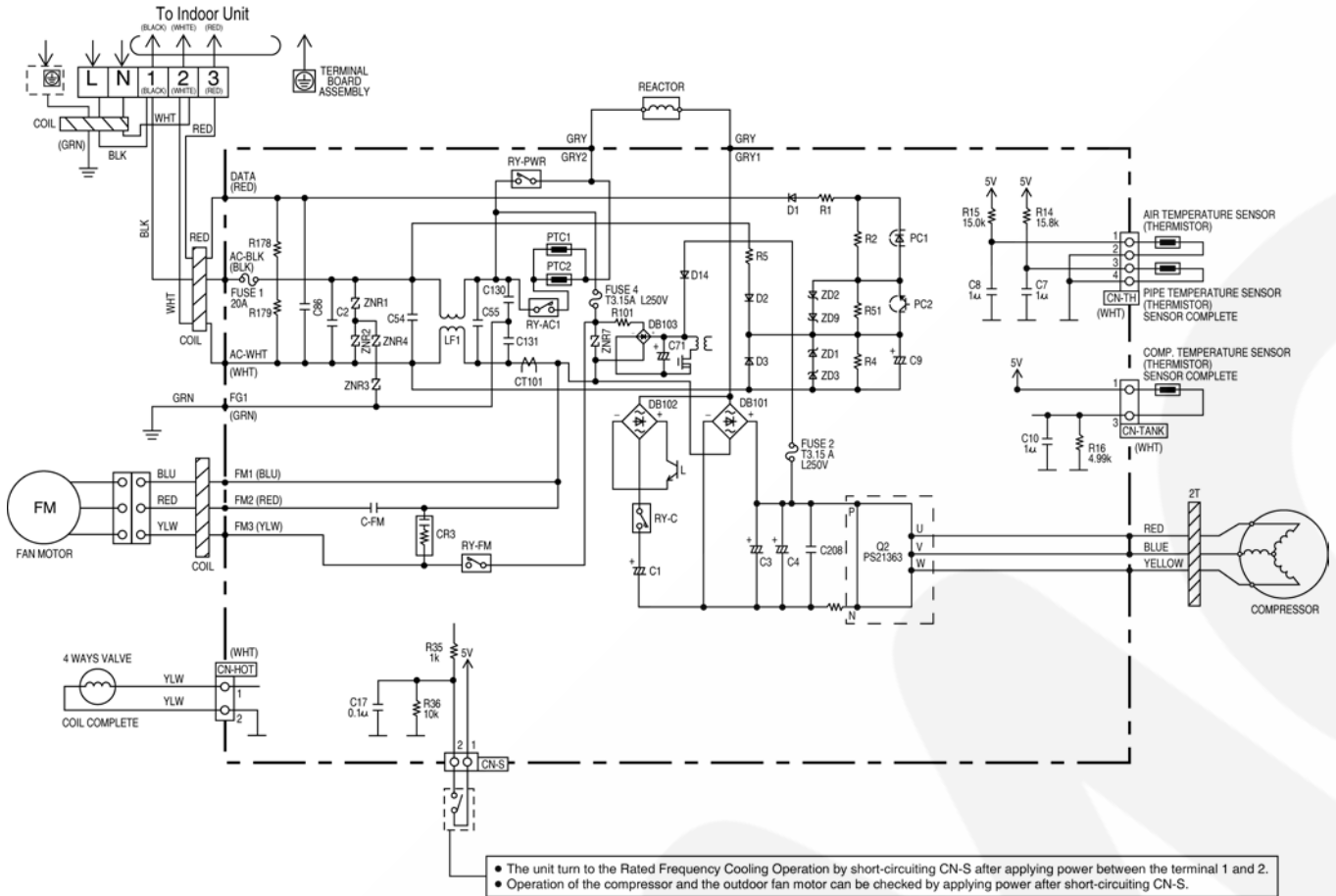

# 10 Printed Circuit Board

## 10.1. Indoor Unit

### 10.1.1. Main Printed Circuit Board

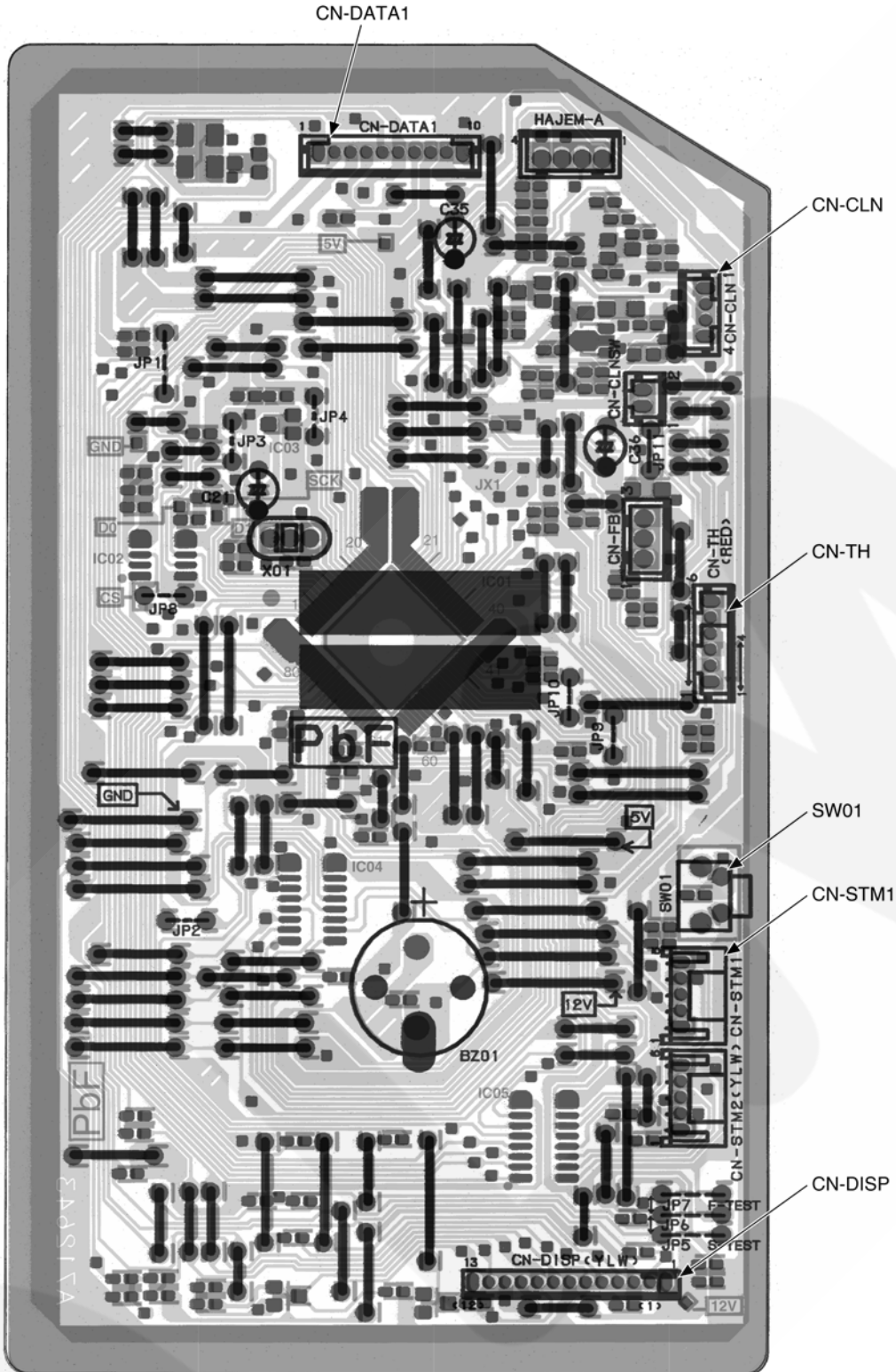

### 10.1.2. Power Printed Circuit Board

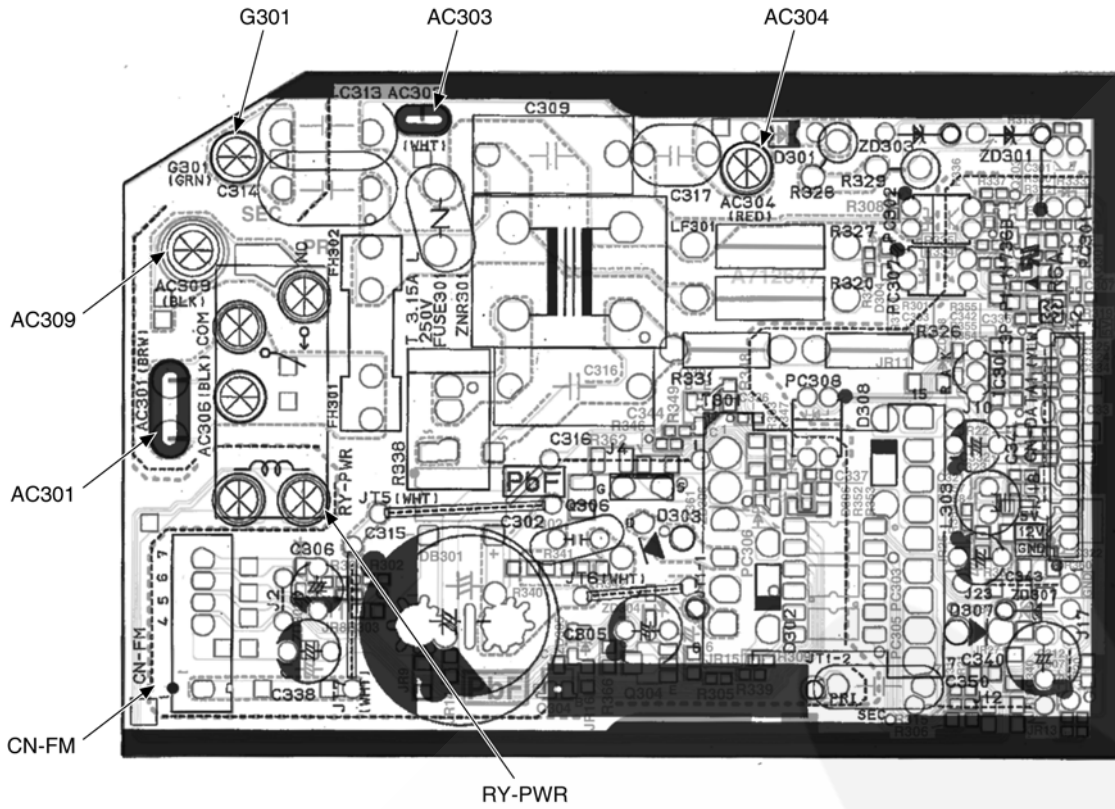

### 10.1.3. Indicator Panel

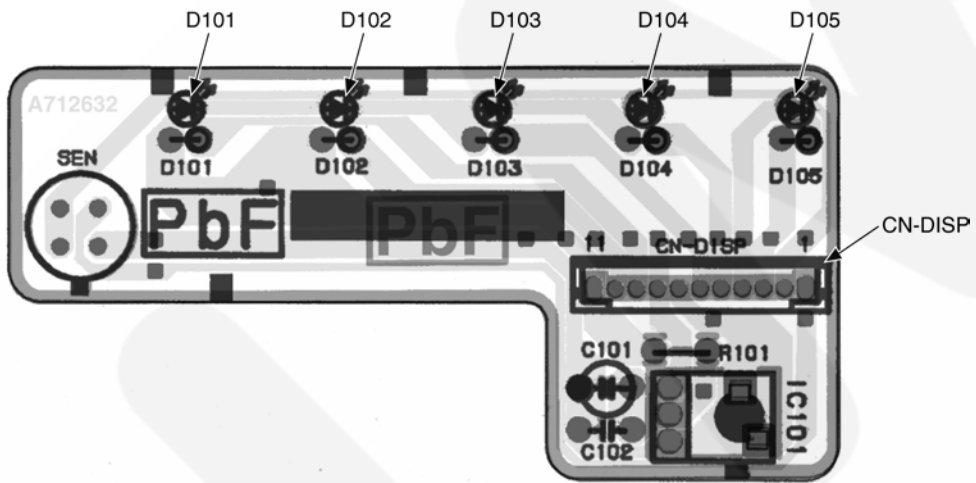

### 10.1.4. Patrol

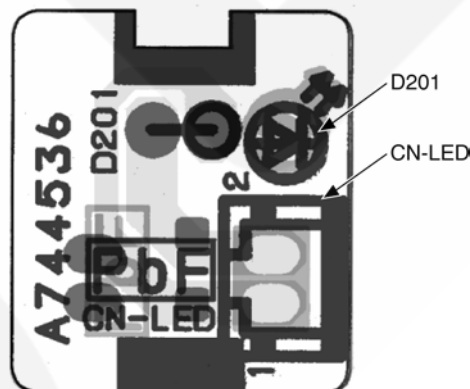

## 10.2. Outdoor Unit

### 10.2.1. Main Printed Circuit Board

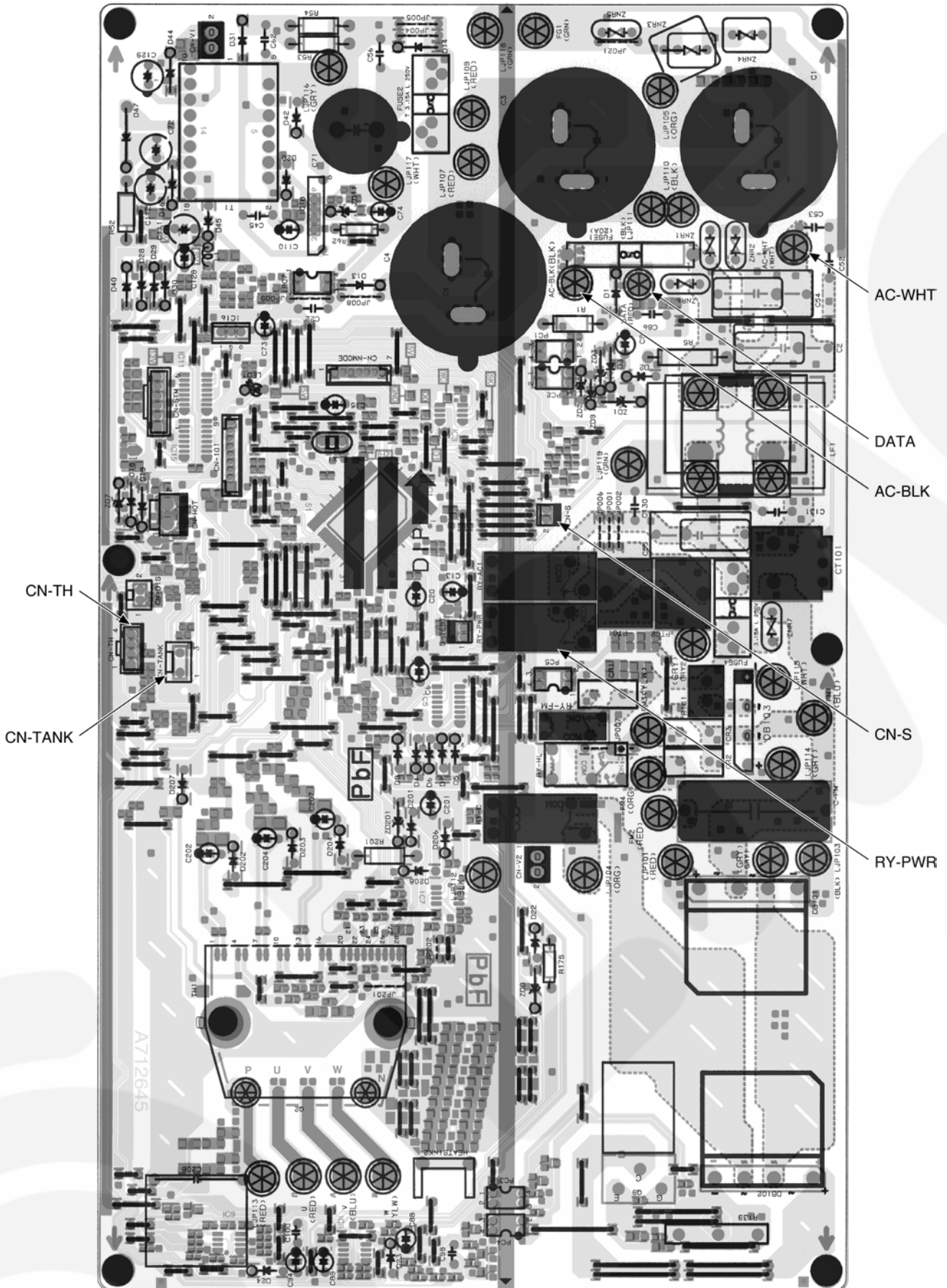

# 11 Installation Instruction

## 11.1. Select The Best Location

### INDOOR UNIT

- There should not be any heat source or steam near the unit.
- There should not be any obstacles blocking the air circulation.
- A place where air circulation in the room is good.
- A place where drainage can be easily done.
- A place where noise prevention is taken into consideration.
- Do not install the unit near the door way.
- Ensure the spaces indicated by arrows from the wall, ceiling, fence or other obstacles.
- Recommended installation height for indoor unit shall be at least 2.5 m.

### OUTDOOR UNIT

- If an awning is built over the unit to prevent direct sunlight or rain, be careful that heat radiation from the condenser is not obstructed.
- There should not be any animal or plant which could be affected by hot air discharged.
- Keep the spaces indicated by arrows from wall, ceiling, fence or other obstacles.
- Do not place any obstacles which may cause a short circuit of the discharged air.
- If piping length is over the rated length, additional refrigerant should be added as shown in the table.

Model	Piping size		Rated Length (m)	Max Elevation (m)	Min. Piping Length (m)	Max. Piping Length (m)	Additional Refrigerant (g/m)
	Gas	Liquid					
E9GK	3/8"	1/4"	7.5	15	3	15	20
E12GK	1/2"	1/4"	7.5	15	3	15	20

Example: For E7GK

If the unit is installed at 10 m distance, the quantity of additional refrigerant should be 50g .....  $(10 - 7.5) \text{ m} \times 20 \text{ g/m} = 50 \text{ g}$

## 11.2. Indoor/Outdoor Unit Installation Diagram

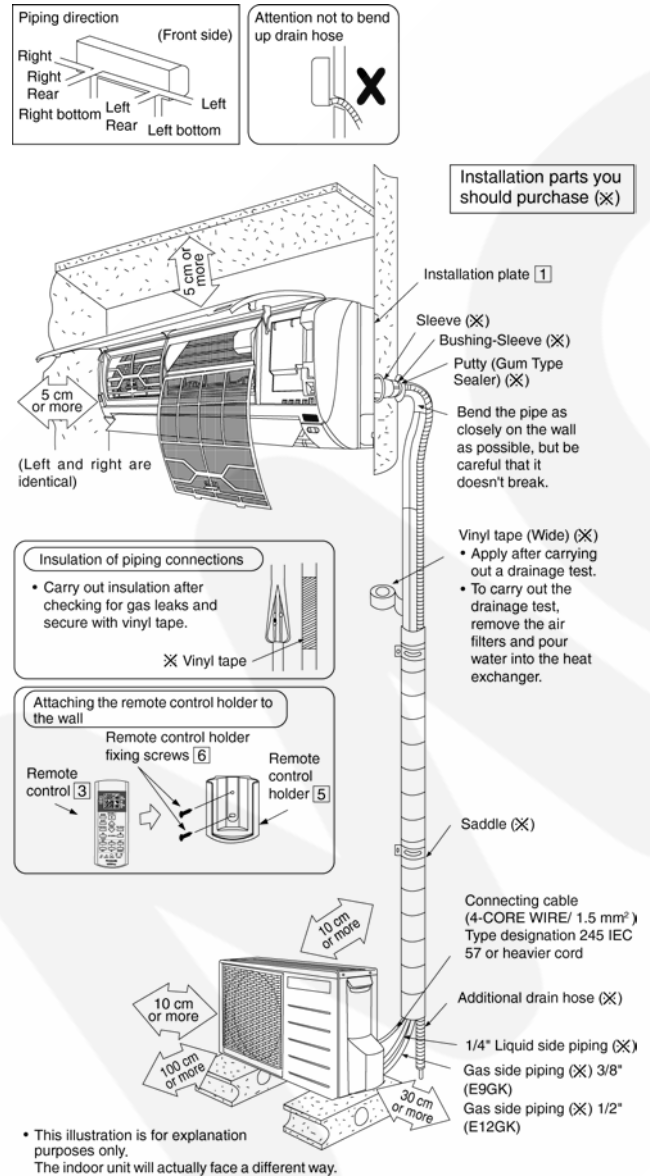

## 11.3. Indoor Unit

### 11.3.1. HOW TO FIX INSTALLATION PLATE

The mounting wall is strong and solid enough to prevent it from the vibration.

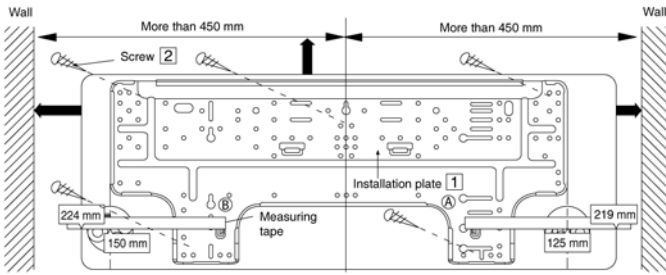

The centre of installation plate should be at more than 450 mm at right and left of the wall.

The distance from installation plate edge to ceiling should more than 67 mm.

From installation plate left edge to unit's left side is 74 mm.

From installation plate right edge to unit's right is 94 mm.

- (B) :
- For left side piping, piping connection for liquid should be about 15 mm from this line.
  - For left side piping, piping connection for gas should be about 45 mm from this line.
  - For left side piping, piping connection cable should be about 800 mm from this line.

1. Mount the installation plate on the wall with 5 screws or more.  
(If mounting the unit on the concrete wall, consider using anchor bolts.)
  - Always mount the installation plate horizontally by aligning the marking-off line with the thread and using a level gauge.

2. Drill the piping plate hole with  $\varnothing 70$  mm hole-core drill.
  - Line according to the left and right side of the installation plate. The meeting point of the extended line is the centre of the hole. Another method is by putting measuring tape at position as shown in the diagram above. The hole centre is obtained by measuring the distance namely 150 mm and 125 mm for left and right hole respectively.
  - Drill the piping hole at either the right or the left and the hole should be slightly slanted to the outdoor side.

### 11.3.2. TO DRILL A HOLE IN THE WALL AND INSTALL A SLEEVE OF PIPING

1. Insert the piping sleeve to the hole.
2. Fix the bushing to the sleeve.
3. Cut the sleeve until it extrudes about 15 mm from the wall.

#### Caution

When the wall is hollow, please be sure to use the sleeve for tube ass'y to prevent dangers caused by mice biting the connecting cable.

4. Finish by sealing the sleeve with putty or caulking compound at the final stage.

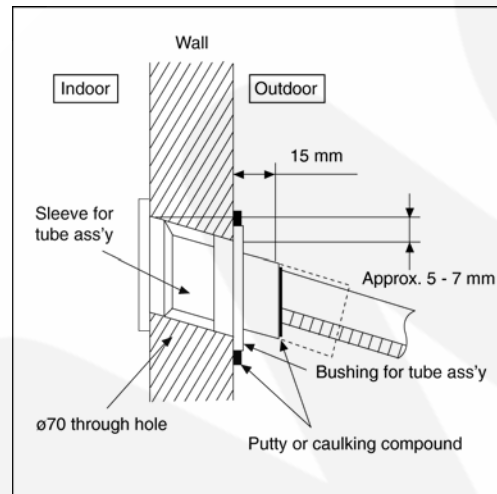

### 11.3.3. INDOOR UNIT INSTALLATION

#### 1. For the right rear piping

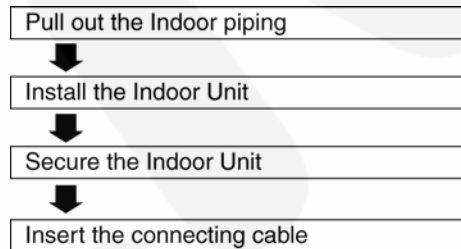

#### 2. For the right and right bottom piping

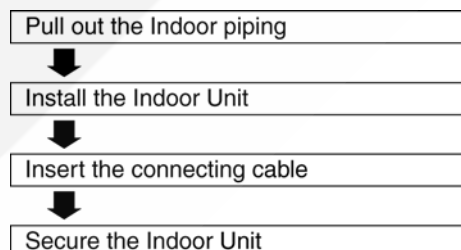

### 3. For the embedded piping

- Replace the drain hose
- Bend the embedded piping
  - Use a spring bender or equivalent to bend the piping so that the piping is not crushed.
- Install the Indoor Unit
- Cut and flare the embedded piping
  - When determining the dimensions of the piping, slide the unit all the way to the left on the installation plate.
  - Refer to the section "Cutting and flaring the piping".
- Pull the connecting cable into Indoor Unit
  - The inside and outside connecting cable can be connected without removing the front grille.
- Connect the piping
  - Please refer to "Connecting the piping" column in outdoor unit section. (Below steps are done after connecting the outdoor piping and gas-leakage confirmation.)
- Insulate and finish the piping
  - Please refer to "Piping and finishing" column of outdoor section and "Insulation of piping connections" column as mentioned in Indoor/Outdoor Unit Installation.
- Secure the Indoor Unit

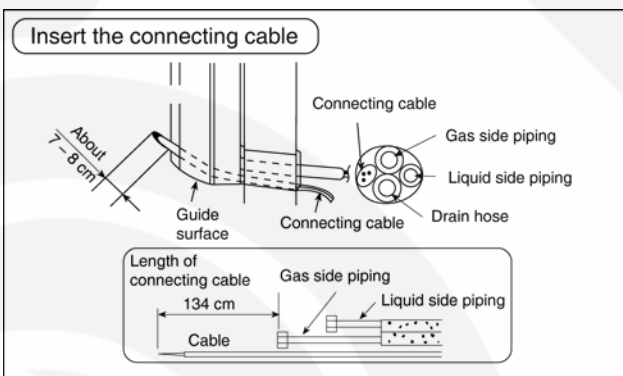
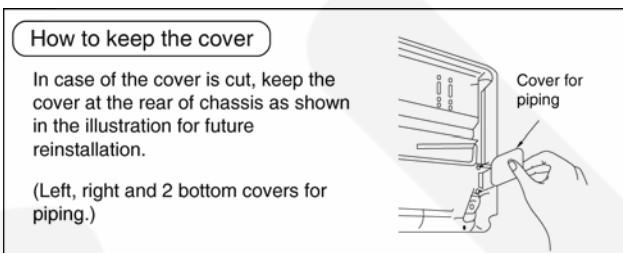
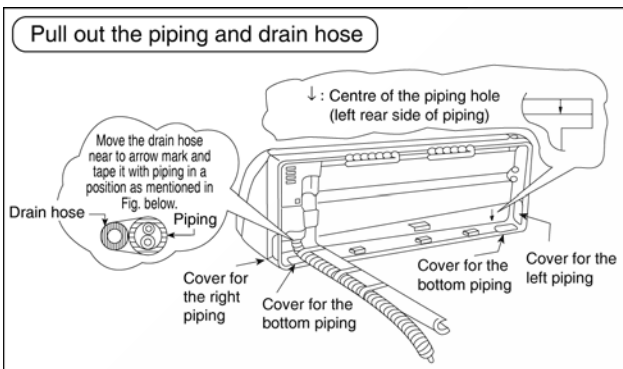
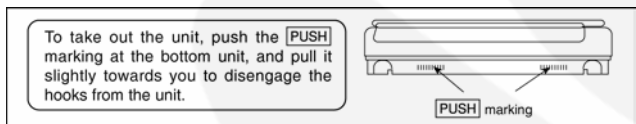
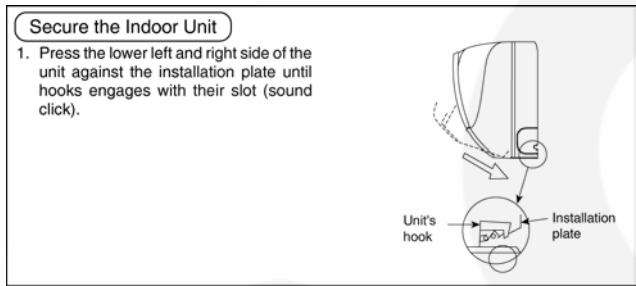
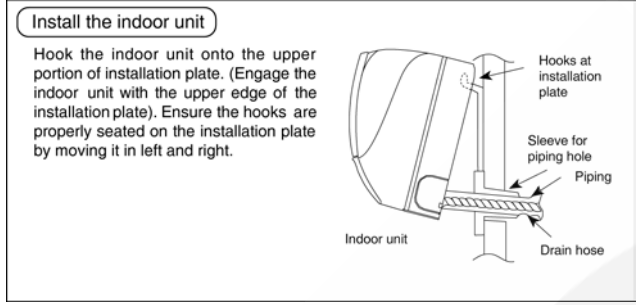

(This can be used for left rear piping and left bottom piping also.)

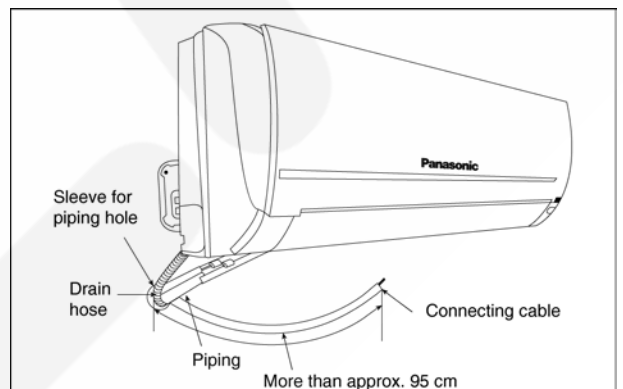
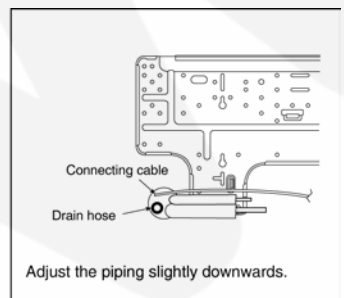
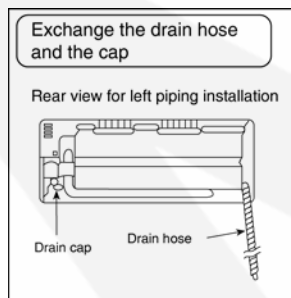

- How to pull the piping and drain hose out, in case of the embedded piping.

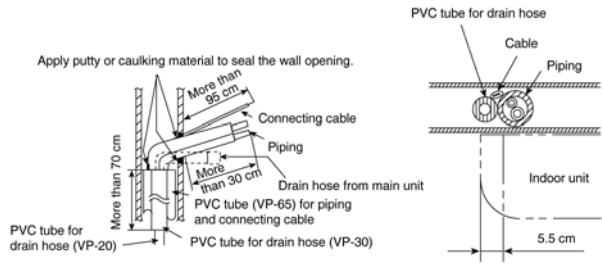

- In case of left piping how to insert the connecting cable and drain hose.

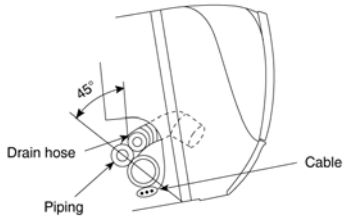

(For the right piping, follow the same procedure)

### 11.3.4. CONNECT THE CABLE TO THE INDOOR UNIT

1. The inside and outside connecting cable can be connected without removing the front grille.
2. Connecting cable between indoor unit and outdoor unit shall be approved polychloroprene sheathed  $4 \times 1.5 \text{ mm}^2$  flexible cord, type designation 245 IEC 57 or heavier cord.

- Ensure the colour of wires of outdoor unit and the terminal Nos. are the same to the indoor's respectively.
- Earth lead wire shall be longer than the other lead wires as shown in the figure for the electrical safety in case of the slipping out of the cord from the anchorage.

Terminals on the indoor unit	1	2	3	
Colour of wires				
Terminals on the outdoor unit	1	2	3	

- Secure the cable onto the control board with the holder (clammer).

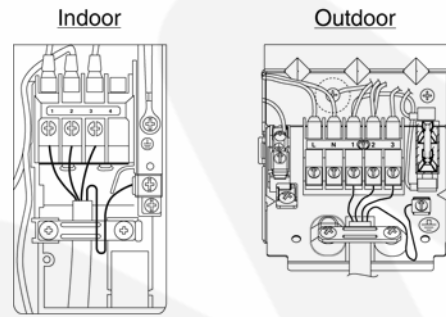



## 11.4. Outdoor Unit

### 11.4.1. INSTALL THE OUTDOOR UNIT

- After selecting the best location, start installation according to Indoor/Outdoor Unit Installation Diagram.
- 1. Fix the unit on concrete or rigid frame firmly and horizontally by bolt nut ( $\phi 10$  mm).
- 2. When installing at roof, please consider strong wind and earthquake. Please fasten the installation stand firmly with bolt or nails.

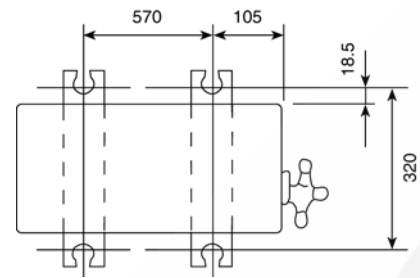

### 11.4.2. CONNECTING THE PIPING

#### Connecting The Piping To Indoor Unit

Please make flare after inserting flare nut (locate at joint portion of tube assembly) onto the copper pipe (in case of using long piping).

Connect the piping

- Align the center of piping and sufficiently tighten the flare nut with fingers.
- Further tighten the flare nut with torque wrench in specified torque as stated in the table.

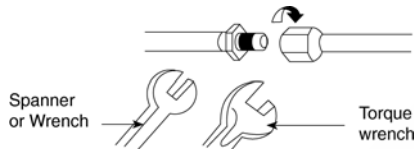

Model	Piping size (Torque)	
	Gas	Liquid
E9GK	3/8" [42 N•m]	1/4" [18 N•m]
E12GK	1/2" [55 N•m]	1/4" [18 N•m]

#### Connecting The Piping To Outdoor Unit

Decide piping length and then cut by using pipe cutter. Remove burrs from cut edge. Make flare after inserting the flare nut (locate at valve) onto the copper pipe.

Align center of piping to valves and then tighten with torque wrench to the specified torque as stated in the table.

#### CUTTING AND FLARING THE PIPING

1. Please cut using pipe cutter and then remove the burrs.
2. Remove the burrs by using reamer. If burrs is not removed, gas leakage may be caused.  
Turn the piping end down to avoid the metal powder entering the pipe.
3. Please make flare after inserting the flare nut onto the copper pipes.

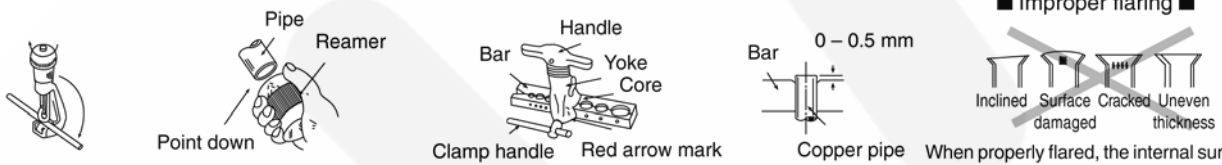

1. To cut

2. To remove burrs

3. To flare

When properly flared, the internal surface of the flare will evenly shine and be of even thickness. Since the flare part comes into contact with the connections, carefully check the flare finish.

### 11.4.3. EVACUATION OF THE EQUIPMENT

WHEN INSTALLING AN AIR CONDITIONER, BE SURE TO EVACUATE THE AIR INSIDE THE INDOOR UNIT AND PIPES in the following procedure.

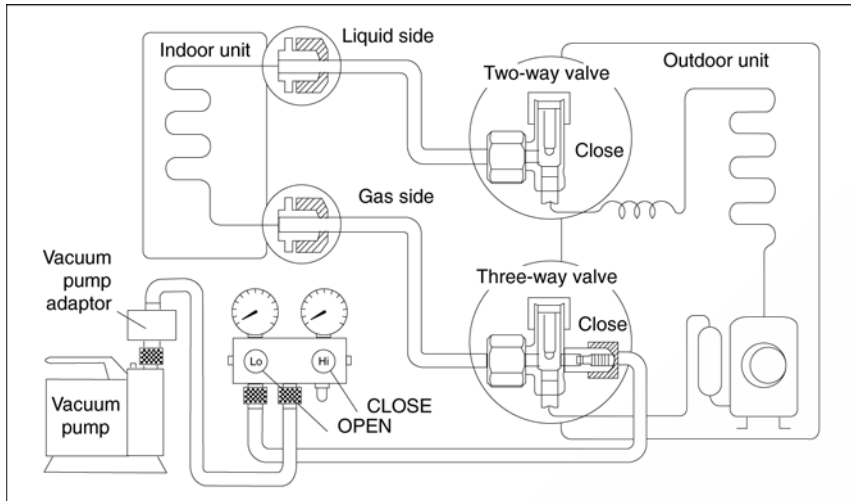

1. Connect a charging hose with a push pin to the Low side of a charging set and the service port of the 3-way valve.
  - Be sure to connect the end of the charging hose with the push pin to the service port.
2. Connect the center hose of the charging set to a vacuum pump with check valve, or vacuum pump and vacuum pump adaptor.
3. Turn on the power switch of the vacuum pump and make sure that the needle in the gauge moves from 0 cmHg (0 MPa) to -76 cmHg (-0.1 MPa). Then evacuate the air approximately ten minutes.
4. Close the Low side valve of the charging set and turn off the vacuum pump. Make sure that the needle in the gauge does not move after approximately five minutes.

Note: BE SURE TO FOLLOW THIS PROCEDURE IN ORDER TO AVOID REFRIGERANT GAS LEAKAGE.

5. Disconnect the charging hose from the vacuum pump and from the service port of the 3-way valve.
6. Tighten the service port caps of the 3-way valve at a torque of 18 N•m with a torque wrench.
7. Remove the valve caps of both of the 2-way valve and 3-way valve. Position both of the valves to “OPEN” using a hexagonal wrench (4 mm).
8. Mount valve caps onto the 2-way valve and the 3-way valve.
  - Be sure to check for gas leakage.

#### CAUTION

- If gauge needle does not move from 0 cmHg (0 MPa) to -76 cmHg (-0.1 MPa), in step ③ above take the following measure:
- If the leak stops when the piping connections are tightened further, continue working from step ③.
- If the leak does not stop when the connections are retightened, repair the location of leak.
- Do not release refrigerant during piping work for installation and reinstallation. Take care of the liquid refrigerant, it may cause frostbite.

### 11.4.4. CONNECT THE CABLE TO THE OUTDOOR UNIT

(FOR DETAIL REFER TO WIRING DIAGRAM AT UNIT)

1. Remove the control board cover from the unit by loosening the screw.
2. Connecting cable between indoor unit and outdoor unit shall be approved polychloroprene sheathed 4 x 1.5 mm<sup>2</sup> flexible cord, type designation 245 IEC 57 or heavier cord.

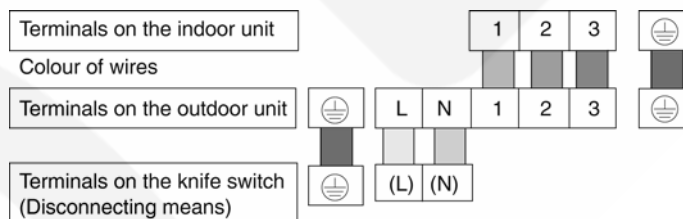

3. Secure the cable onto the control board with the holder (clammer).

4. Cable connection to the power supply through knife switch (Disconnecting means).

- Connect the approved polychloroprene sheathed power supply cable (3 x 1.5 mm<sup>2</sup>), type designation 245 IEC 57 or heavier cord to the terminal board, and connect the other end of the cable to knife switch (Disconnecting means).

Note: Knife switch (Disconnecting means) should have minimum 3.5 mm contact gap.

- Secure the cable onto the control board with the holder (clammer).

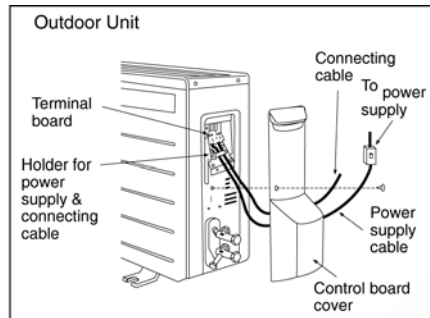

# 12 Operation and Control

## 12.1. Basic Function

Inverter control, which equipped with a microcomputer in determining the most suitable operating mode as time passes, automatically adjusts output power for maximum comfort always. In order to achieve the suitable operating mode, the microcomputer maintains the set temperature by measuring the temperature of the environment and performing temperature shifting. The compressor at outdoor unit is operating following the frequency instructed by the microcomputer at indoor unit that judging the condition according to internal setting temperature and intake air temperature.

### 12.1.1. Internal Setting Temperature

Once the operation starts, remote control setting temperature will be taken as base value for temperature shifting processes. These shifting processes are depending on the air conditioner settings and the operation environment. The final shifted value will be used as internal setting temperature and it is updated continuously whenever the electrical power is supplied to the unit.

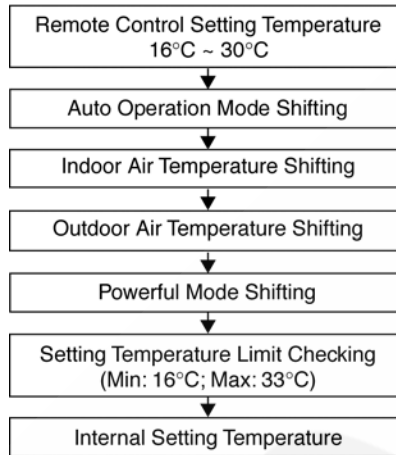

### 12.1.2. Cooling Operation

#### 12.1.2.1. Thermostat control

- Compressor is OFF when Intake Air Temperature - Internal Setting Temperature < -1.5°C.
- Compressor is ON after waiting for 3 minutes, if the Intake Air Temperature - Internal Setting Temperature > Compressor OFF point.

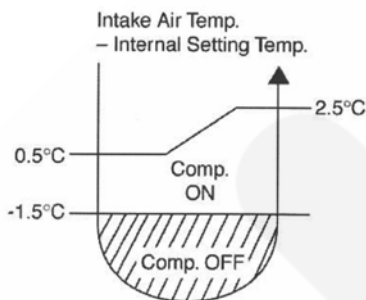

### 12.1.3. Soft Dry Operation

#### 12.1.3.1. Thermostat control

- Compressor is OFF when Intake Air Temperature - Internal Setting Temperature < -1.5°C.
- Compressor is ON after waiting for 3 minutes, if the Intake Air Temperature - Internal Setting Temperature > Compressor OFF point.

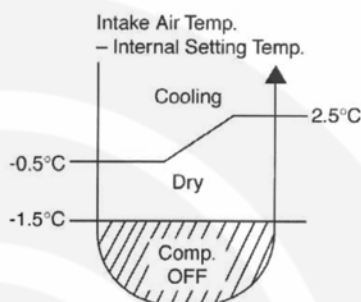

## 12.1.4. Heating Operation

### 12.1.4.1. Thermostat control

- Compressor is OFF when Intake Air Temperature - Internal Setting Temperature > +2.0°C.
- Compressor is ON after waiting for 3 minutes, if the Intake Air Temperature - Internal Setting Temperature < Compressor OFF point.

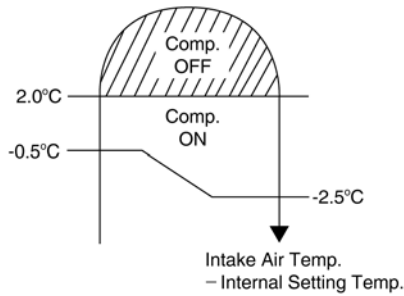

## 12.1.5. Automatic Operation

- This mode can be set using remote control and the operation is decided by remote control setting temperature, remote control operation mode, indoor intake air temperature and outdoor air temperature.
- During operation mode judgment, indoor fan motor (with speed of Lo-) and outdoor fan motor are running for 30 seconds to detect the indoor intake and outdoor air temperature. The operation mode is decided based on below chart.

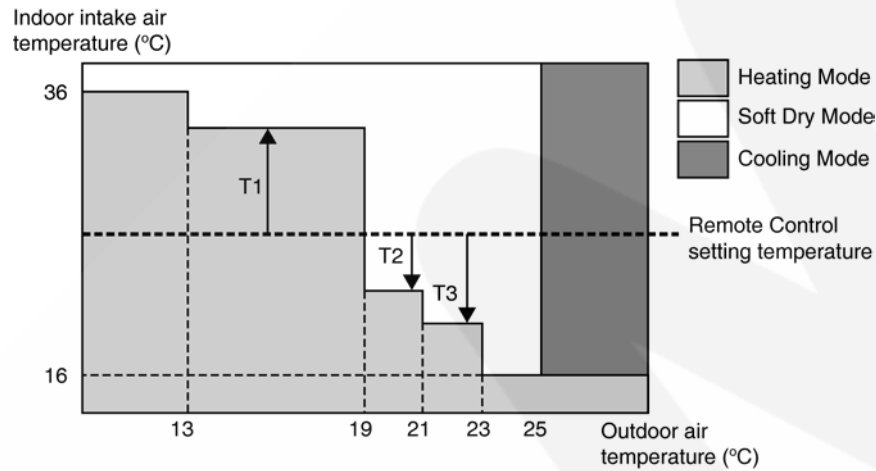

Values of T1, T2, and T3 depend on remote control setting temperature, as shown in below table. After the adjustment of T1, T2 and T3 values, the operation mode for that particular environment and remote control setting is judged and performed, based on the above operation mode chart, every 30 minutes.

Remote Control Setting Temperature (°C)	T1	T2	T3
16 ~ 18	+10	-3	-5
19 ~ 22	+8	-3	-7
23 ~ 26	+7	-3	-7
27 ~ 30	+6	-3	-8

There is a temperature shifting on T1, T2 and T3 if the operation mode judged is changed from Cooling/Soft Dry to Heating or vice versa.

Operation Mode change from	Temperature shifts (°C)
Cooling/Soft Dry → Heating	-2
Heating → Cooling/Soft Dry	+2

Example of operation mode chart adjustment:

From the above table, if remote control setting temperature = 25,

$T1 = 25 + 7 = 32$ ;  $T2 = 25 - 3 = 22$ ;  $T3 = 25 - 7 = 18$

The operation mode chart for this example is as shown in below figure and the operation mode to be performed will depend on indoor intake air temperature and outdoor air temperature at the time when the judgment is made.

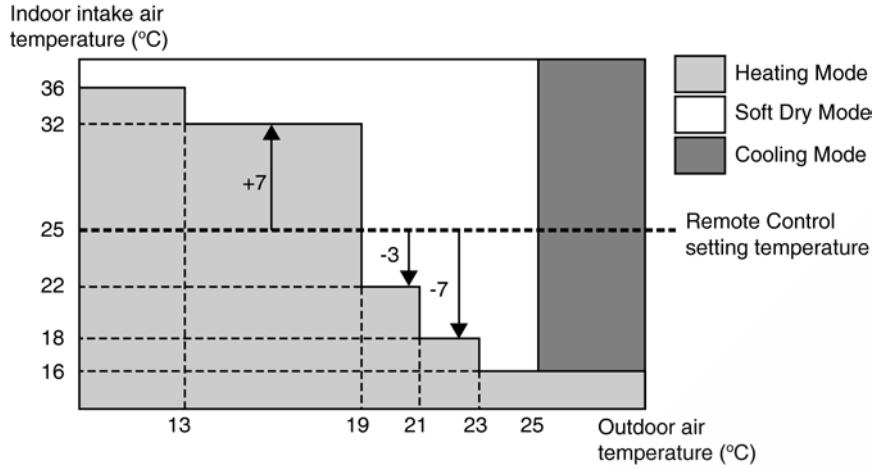

### 12.1.6. Indoor Fan Motor Operation

#### A. Basic Rotation Speed (rpm)

##### i. Manual Fan Speed

[Cooling, Dry]

- Fan motor's number of rotation is determined according to remote control setting.

Remote Control	O	O	O	O	O
Tab (rpm)	SHi	Me+	Me	Me-	Lo

[Heating]

- Fan motor's number of rotation is determined according to remote control setting.

Remote Control	O	O	O	O	O
Tab (rpm)	Hi	Me+	Me	Me-	Lo

##### ii. Auto Fan Speed

[Cooling, Dry]

- According to room temperature and setting temperature, indoor fan speed is determined automatically.
- The indoor fan will operate according to pattern below.

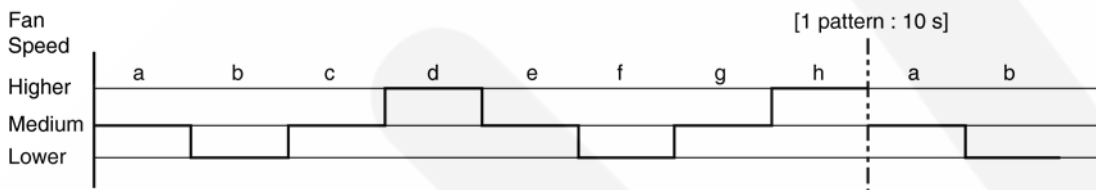

[Heating]

- According to indoor pipe temperature, automatic heating fan speed is determined as follows.

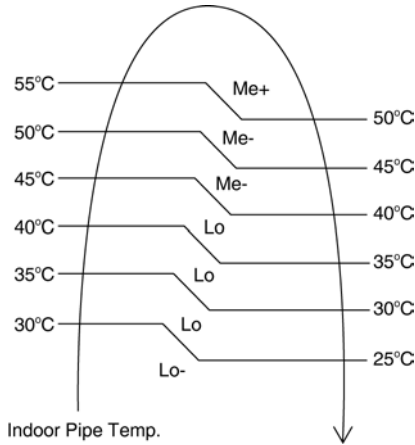

**B. Feedback control**

- Immediately after the fan motor started, feedback control is performed once every second.
- During fan motor on, if fan motor feedback  $\geq 2550$  rpm or  $< 50$  rpm continue for 10 seconds, then fan motor error counter increase, fan motor is then stop and restart. If the fan motor counter becomes 7 times, then H19 - fan motor error is detected. Operation stops and cannot on back.

**12.1.7. Outdoor Fan Motor Operation**

Outdoor fan motor is operated with one fan speed only. It starts when compressor starts operation and it stops 30 seconds after compressor stops operation.

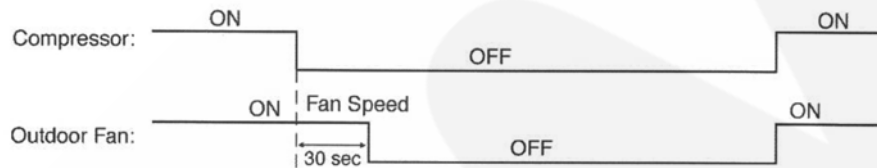

**12.1.8. Airflow Direction**

1. There are two types of airflow, vertical airflow (directed by horizontal vane) and horizontal airflow (directed by vertical vanes).
2. Control of airflow direction can be automatic (angles of direction is determined by operation mode, heat exchanger temperature and intake air temperature) and manual (angles of direction can be adjusted using remote control).

**12.1.8.1. Vertical Airflow**

Operation Mode	Airflow Direction		Vane Angle (°)				
			1	2	3	4	5
Heating	Auto with Heat Exchanger Temperature	A	Upward fix		0		
		B	Downward fix		45		
		C	Upward fix		0		
		D	Downward fix		0		
	Manual		12	25	37	49	60
Cooling and Ion	Auto (Anti-Dew Control)		10 ~ 32 (22 ~ 30)				
	Manual (Anti-Dew Control)		12 (22)	18	25	31	37 (30)
Soft Dry	Auto (Anti-Dew Control)		10 ~ 32 (22 ~ 30)				
	Manual (Anti-Dew Control)		12 (22)	18	25	31	37 (30)

1. Automatic vertical airflow direction can be set using remote control; the vane swings up and down within the angles as stated above. For heating mode operation, the angle of the vane depends on the indoor heat exchanger temperature as Figure 1 below. When the air conditioner is stopped using remote control, the vane will shift to close position.

2. Manual vertical airflow direction can be set using remote control; the angles of the vane are as stated above and the positions of the vane are as Figure 2 below. When the air conditioner is stopped using remote control, the vane will shift to close position.

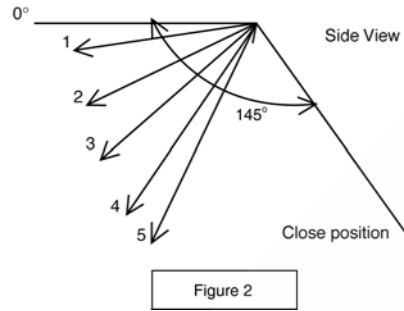
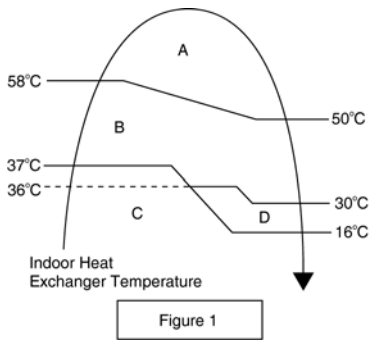

### 12.1.8.2. Horizontal Airflow

- The horizontal airflow direction louvers can be adjusted manually by hand.

### 12.1.9. Quiet operation (Cooling Mode/Cooling area of Dry Mode)

#### A. Purpose

To provide quiet cooling operation compare to normal operation.

#### B. Control condition

a. Quiet operation start condition

- When “quiet” button at remote control is pressed.  
Quiet LED illuminates.

b. Quiet operation stop condition

1. When one of the following conditions is satisfied, quiet operation stops:
  - a. Powerful button is pressed.
  - b. Stop by OFF/ON switch.
  - c. Timer “off” activates.
  - d. Quiet button is pressed again.
2. When quiet operation is stopped, operation is shifted to normal operation with previous setting.
3. When fan speed is changed, quiet operation is shifted to quiet operation of the new fan speed.
4. When operation mode is changed, quiet operation is shifted to quiet operation of the new mode.
5. During quiet operation, if timer “on” activates, quiet operation maintains.
6. After off, when on back, quiet operation is not memorised.

#### C. Control contents

1. Fan speed is changed from normal setting to quiet setting of respective fan speed.  
This is to reduce sound of Hi, Me, Lo for 3dB.
2. Fan speed for quiet operation is -1 step from setting fan speed.

### 12.1.10. Quiet operation (Heating)

#### A. Purpose

To provide quiet heating operation compare to normal operation.

#### B. Control condition

a. Quiet operation start condition

- When “quiet” button at remote control is pressed.  
Quiet LED illuminates.

b. Quiet operation stop condition

1. When one of the following conditions is satisfied, quiet operation stops:
  - a. Powerful button is pressed.
  - b. Stop by OFF/ON switch.
  - c. Timer “off” activates.
  - d. Quiet button is pressed again.
2. When quiet operation is stopped, operation is shifted to normal operation with previous setting.
3. When fan speed is changed, quiet operation is shifted to quiet operation of the new fan speed.



4. When operation mode is changed, quiet operation is shifted to quiet operation of the new mode, expect fan only mode.
5. During quiet operation, if timer "on" activates, quiet operation maintains.
6. After off, when on back, quiet operation is not memorised.

**C. Control contents**

a. Fan Speed manual

1. Fan speed is changed from normal setting to quiet setting of respective fan speed.  
This is to reduce sound of Hi, Me, Lo for 3dB.
2. Fan speed for quiet operation is -1 step from setting fan speed.
3. Fan Speed Auto  
Indoor FM RPM depends on pipe temp sensor of indoor heat exchanger.

**12.1.11. Powerful Mode Operation**

When the powerful mode is selected, the internal setting temperature will shift to achieve the setting temperature quickly.

(a) Cooling Operation

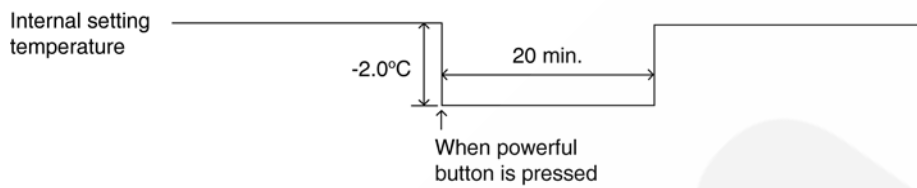

(b) Soft Dry Operation

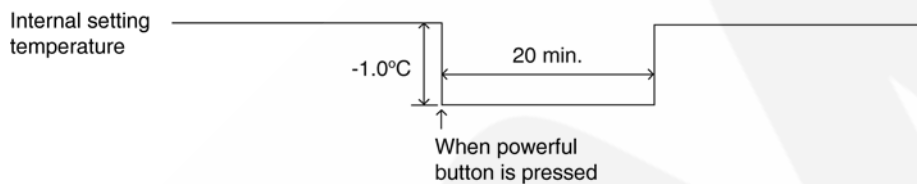

(c) Heating Operation

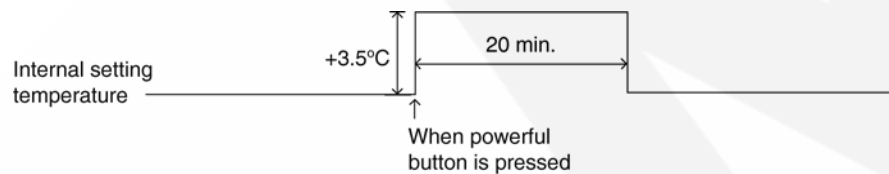

**12.1.12. ON Timer Control**

ON timer can be set using remote control, the unit with timer set will start operate earlier than the setting time. This is to provide a comfortable environment when reaching the set ON time.

60 minutes before the set time, indoor (at fan speed of Lo-) and outdoor fan motor start operate for 30 seconds to determine the indoor intake air temperature and outdoor air temperature in order to judge the operation starting time.

From the above judgment, the decided operation will start operate earlier than the set time as shown below.

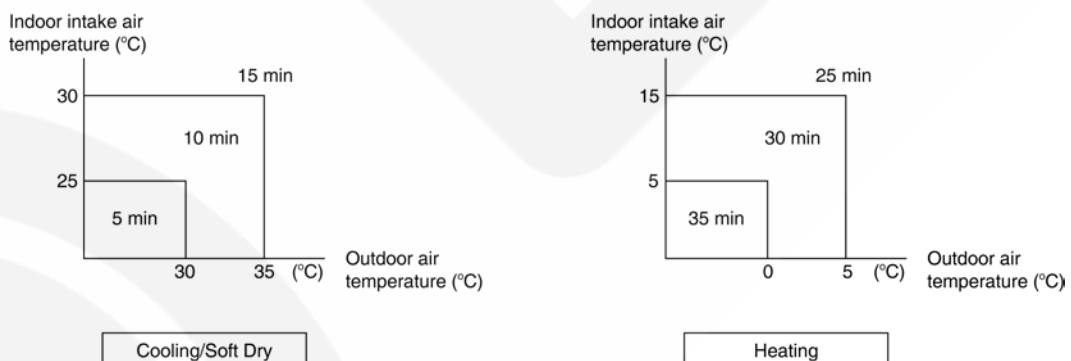

### 12.1.13. OFF Timer Control

OFF timer can be set using remote control, the unit with timer set will stop operate at set time.

### 12.1.14. Auto Restart Control

1. When the power supply is cut off during the operation of air conditioner, the compressor will re-operate within three to four minutes (there are 10 patterns between 2 minutes 58 seconds and 3 minutes 52 seconds to be selected randomly) after power supply resumes.
2. This type of control is not applicable during ON/OFF Timer setting.

### 12.1.15. Indication Panel

LED	POWER	TIMER	QUIET	POWERFUL	e-ion	PATROL SENSOR
Color	Green	Orange	Orange	Orange	Blue	Blue
Light ON	Operation ON	Quiet Setting ON	Quiet Mode ON	Powerful Mode ON	e-ion ON	PATROL ON
Light OFF	Operation OFF	Quiet Setting OFF	Quiet Mode OFF	Powerful Mode OFF	e-ion OFF	PATROL OFF

- Note:
- If POWER LED is blinking, the possible operation of the unit are Hot Start, during Deice operation, operation mode judgment, or ON timer sampling.
  - If Timer LED is blinking, there is an abnormality operation occurs.
  - If e-ion LED is blinking, there is an abnormality of e-ion occurs.
  - If PATROL LED is blinking, there is a gas sensor error detection.

### 12.1.16. Patrol Operation

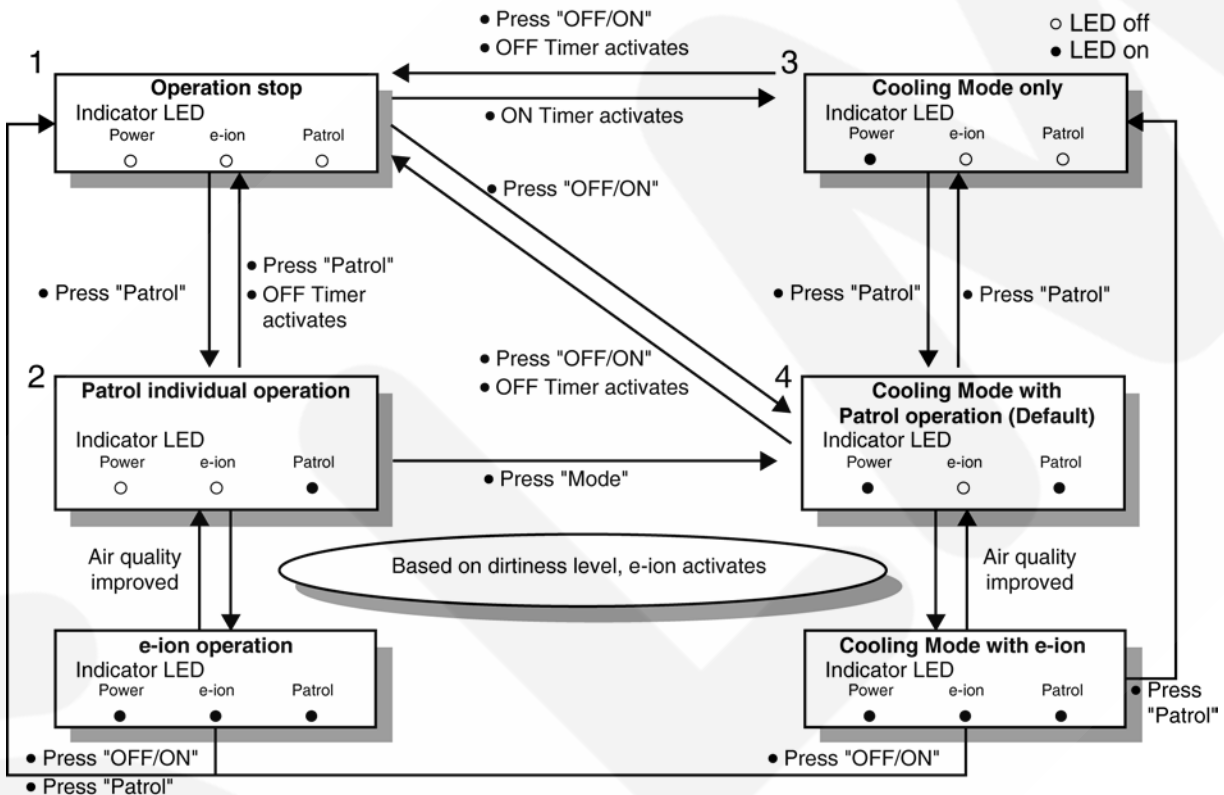

#### A. Purpose

To monitor air dirtiness level by using gas sensor and activates e-ion operation whenever air is dirty.

#### B. Control Condition

- Patrol operation start condition
  - When the unit operation is started with "OFF/ON" button.
  - When the unit stops, "Patrol" button is pressed, Patrol individual operation will start.
  - During cooling only operation, "Patrol" button is pressed.

b. Patrol operation stop condition

When any of the following condition is fulfilled:

- When "OFF/ON" button is pressed.
- During any operation with Patrol, "Patrol" button is pressed again.
- When "e-ion" button is pressed.
- When OFF Timer activates.

c. Patrol operation disable

- To disable the Patrol Operation during unit start (default) with "OFF/ON" button, press "Patrol" button and hold for 5 seconds, then release.
- To disable the Patrol Operation, press "Patrol" button and hold for 15 seconds, then release.

**C. Control Content**

a. Gas Sensor Control

- First 2 minutes from Patrol function activates is stabilization time, during stabilization time, no air dirtiness level is monitored. The Air Dirtiness level is set to level 2.
- After that, gas sensor starts to record the resistance value at fixed interval. Higher resistance value indicates cleaner air.
- The air dirtiness level is monitored by comparing the current resistance value with maximum resistance value from time to time to get the Air Dirtiness Value.
- There are 3 air dirtiness levels, based on the Air Dirtiness Value:
  - Air Dirtiness level 0: Clean
  - Air Dirtiness level 1: Moderate
  - Air Dirtiness level 2: Contaminated

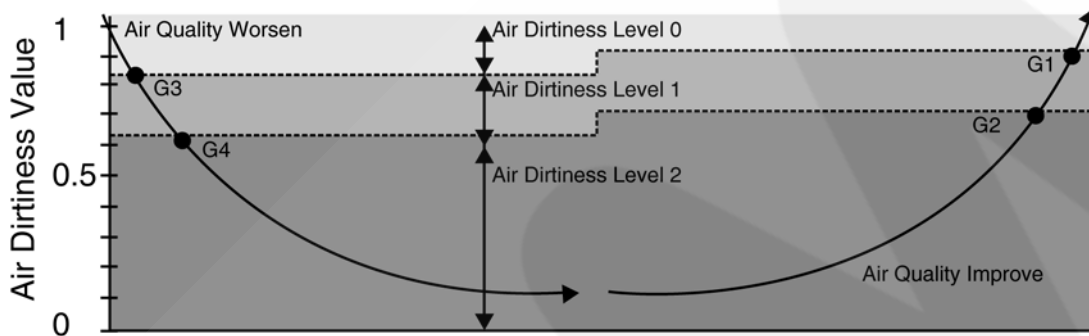

• Dirtiness level sensitivity adjustment

It is possible to change the gas sensor sensitivity, where the Threshold value (G1 ~ G4) will be shifted accordingly:

1. Press and release "SET" button.
2. Press "Timer increment" / "Timer decrement" button to select sensitivity. (Low ↔ Standard (Default) ↔ High)
3. Confirm setting by pressing "Timer Set" button. LCD returned to original display after 2 seconds.
4. LCD returned to original display if remote control does not operate for 30 seconds.

b. e-ion Control

- When dirtiness level is 1 or 2, e-ion operation starts.
- If dirtiness level improves from level 2 to level 1, the unit carries out level change after 60 seconds.
- When dirtiness level returns to level 0 continuously for 10 minutes or more, e-ion operation stops.

Dirtiness Level Shift

- For Auto Fan Speed, the fan speed increased based on dirtiness level:

	Dirtiness level	rpm shift	
		Patrol individual operation	Combine operation
<b>e-ion ON</b>	Dirtiness level 0	No change	No change
	Dirtiness level 1	+ 20	+ 20
	Dirtiness level 2	+ 40	+ 40

c. Indoor Fan Control

- During any operation mode combines with Patrol operation, fan speed follows respective operation mode.
- During Patrol individual operation if e-ion starts, only Auto Fan Speed and no Powerful operation is allowed. Even if "Fan Speed" button is pressed, no signal is sent to air conditioner, and no change on LCD display.
- During Patrol individual operation if e-ion stops, Indoor Fan stop operation.

d. Airflow direction (Horizontal, Vertical) Control

- During any operation mode combines with Patrol operation, airflow direction follows respective operation mode.
- During Patrol individual operation if e-ion starts, only Auto Air Swing is allowed. Even if "Air Swing" button is pressed, no signal is sent to air conditioner, and no change on LCD display.
- During Patrol individual operation if e-ion stops, Airflow direction louver closed.

e. Indicator

- When Patrol operation starts, Patrol Sensor indicator ON.
- When e-ion operation starts based on dirtiness level, e-ion indicator ON.

f. Remote Control Receiving Sound

- Normal Operation → Patrol Mode : Beep
- Patrol Mode → Stop : Long Beep
- Patrol Mode → Normal Operation : Beep
- Stop → Patrol : Beep

g. Timer Control

- When ON timer activates when unit stops, previous operation resumes without Patrol operation.
- When ON timer activates during any operation, no change and carry on current operation.
- When OFF timer activates during any operation, all operation stops.

h. Power failure

- During Patrol individual operation, if power failure occurs, after power resumes, Patrol individual operation resumes immediately.
- During combination operation, if power failure occurs, after power resumes combination operation resume immediately.

### 12.1.17. e-ion Operation

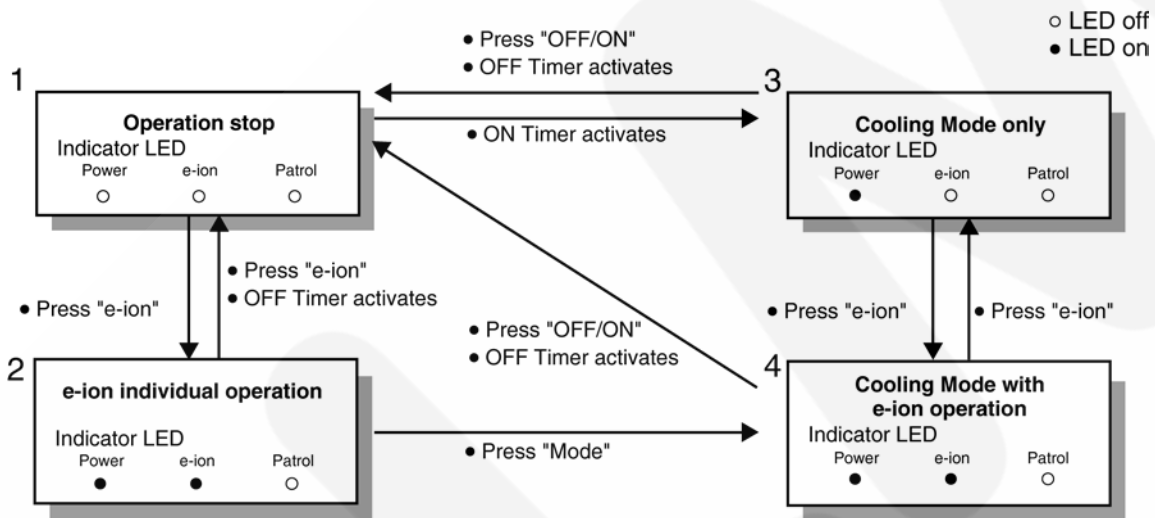

**A. Purpose**

This operation provides clean air by producing negative ions to attract dust captured at the positively charged e-ion filters.

**B. Control Condition**

a. e-ion operation start condition

- During unit running at any operation mode, if "e-ion" button is pressed, combination operation (operation mode + e-ion operation) starts.
- During unit is OFF, if "e-ion" button is pressed, e-ion individual operation starts.

b. e-ion operation stop condition

- When "OFF/ON" button is pressed to stop the operation.
- When "e-ion" button is pressed again.
- When "Patrol" button is pressed.
- When OFF Timer activates.

c. e-ion operation pause condition

- When indoor fan stop (during deice, odor cut control, thermostat off, etc.). e-ion operation resume after indoor fan restarts.
- When indoor intake temperature  $\geq 40^{\circ}\text{C}$ . e-ion operation resume after indoor intake temperature  $< 40^{\circ}\text{C}$  continuously for 30 minutes.

**C. Control Content**

a. Indoor fan control

- During any operation mode combines with e-ion operation, fan speed follows respective operation mode.
- During e-ion individual operation - only Auto Fan Speed and no Powerful operation is allowed. Even if Fan Speed button is pressed, no signal is sent to air conditioner, and no change on LCD display.

Auto Fan Speed for e-ion operation switches between HLo and CLo at pattern below:

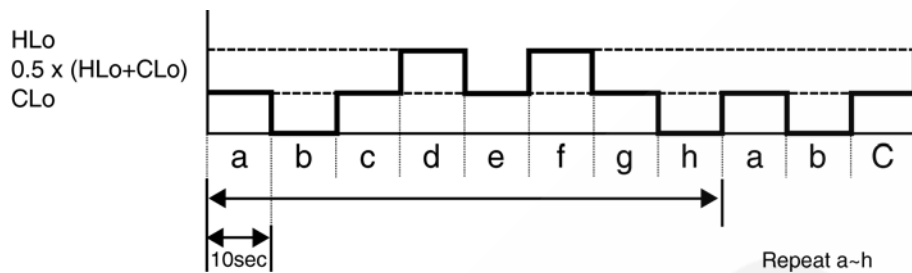

b. Airflow direction control

- During any operation mode combines with e-ion operation, airflow direction follows respective operation mode.
- During e-ion individual operation, only Auto Air Swing is allowed. Even if Air Swing button is pressed, no signal is sent to air conditioner, and no change on LCD display.

c. Timer control

- When ON timer activates when unit stops, previous operation resumes without e-ion operation.
- When ON timer activates during any operation, no change and carry on current operation.
- When OFF timer activates during any operation, all operation stops.

d. Indicator

- When e-ion operation starts, e-ion indicator ON.

e. e-ion Check Mode

- To check if e-ion is malfunctioning, during e-ion operation press “e-ion” button for 15 seconds and release to enter e-ion Check Mode and supplies power to the e-ion Air Purifying System.
- If abnormal discharge is detected at filter (short-circuited) due to water or dust adhesion, etc., the e-ion indicator blinks immediately.

f. Power failure

- During e-ion individual operation, if power failure occurs, after power resumes, e-ion individual operation resumes immediately.
- During combination operation, if power failure occurs, after power resumes, combination operation resume immediately.

g. Error Detection Control

When e-ion indicator blink, it indicates error listed below:

i. e-ion Air Purifying system main connector to PCB is open:

Judgement Method

- During e-ion operation (include during Patrol operation), e-ion Air Purifying system main connector to PCB is opened.

Troubleshooting Methods

- Connect the connector or stop operation (include during Patrol operation) to cancel the blinking.

ii. Abnormal Discharge

Judgement Method

- During e-ion operation, when feedback voltage is -Lo (at microcontroller) is detected, it is judged abnormal discharge and stops power supplies to the e-ion Air Purifying system.
- The unit retries after 30 minutes and repeat for 24 times. (not applicable for e-ion Check Mode)

**Troubleshooting Method**

- Press “e-ion” button or “OFF/ON” button to stop the operation and check the e-ion Air Purifying system main connector to PCB.
- After that, press “e-ion” button again to confirm the e-ion indicator not blinking.
- The 24 times counter will be clear after 10 minutes of normal operation or when operation stops.

**Error Reset Method**

- Press “OFF/ON” button to OFF the operation.
- Press AUTO OFF/ON button at indoor unit to OFF the operation.
- OFF Timer activates.
- Press “e-ion” button during e-ion individual mode.
- Power supply reset.

**iii. e-ion breakdown**

**Judgement Method**

- When hi-feedback voltage (at microcontroller) supplied to filter during e-ion stop, due to PCB or filter’s high voltage power supply damage.
- Operations except e-ion continue. Both Timer indicator and e-ion indicator blink.

**Troubleshooting Method**

- Press “e-ion” button or “OFF/ON” button to stop the operation.
- Change main circuit board or filter’s high voltage power supply.
- When lo-feedback voltage supplied to e-ion Air Purifying system during e-ion operation, e-ion indicator and Timer indicator stop blinking.

## 12.2. Protection Control

### 12.2.1. Protection Control For All Operations

#### 12.2.1.1. Time Delay Safety Control

1. The compressor will not start for 3 minutes after stop of the operation.
2. This control is not applicable if the power supply is cut off and on again or after 4-way valve deices condition.

#### 12.2.1.2. 30 Seconds Forced Operation

1. Once compressor starts the operation, it will not stop its operation for 30 seconds.
2. However, it can be stopped with the remote control or the Auto Switch on the indoor unit.

#### 12.2.1.3. Total Running Current Control

1. When the outdoor unit total running current (AC) exceeds X value, the frequency instructed for compressor operation will be decreased.
2. If the running current does not exceed X value for 5 seconds, the frequency instructed will be increased.
3. However, if total outdoor unit running current exceeds Y value, compressor will be stopped immediately for 3 minutes.

Model	E7GK		E9GK		E12GK	
Operation Mode	X (A)	Y (A)	X (A)	Y (A)	X (A)	Y (A)
Cooling/Soft Dry (A)	3.95	15.0	4.54	15.0	6.86	15.0
Cooling/Soft Dry (B)	3.6	15.0	4.12	15.0	6.35	15.0
Heating	4.37	15.0	5.57	15.0	8.03	15.0

4. The first 30 minutes of cooling operation, (A) will be applied.

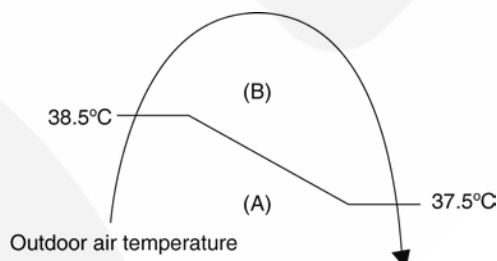

#### 12.2.1.4. IPM (Power transistor) Prevention Control

##### A. Overheating Prevention Control

1. When the IPM temperature rises to 100°C, compressor operation will stop immediately.
2. Compressor operation restarts after 3 minutes the temperature decreases to 95°C.

##### B. DC Peak Current Control

1. When electric current to IPM exceeds set value of 18.5 A, the compressor will stop operate. Then, operation will restart after 3 minutes.
2. If the set value is exceeded again more than 30 seconds after the compressor starts, the operation will restart after 2 minutes.
3. If the set value exceeded again within 30 seconds after the compressor starts, the operation will restart after 1 minute. If this condition repeats continuously for 7 times, all indoor and outdoor relays will be cut off.

#### 12.2.1.5. Compressor Overheating Prevention Control

Instructed frequency for compressor operation will be regulated by compressor discharge temperature. The changes of frequency are as below figure.

If compressor discharge temperature exceeds 110°C, compressor will be stopped, occurs 4 times per 20 minutes, timer LED will be blinking. ("F97" is to be confirmed.)

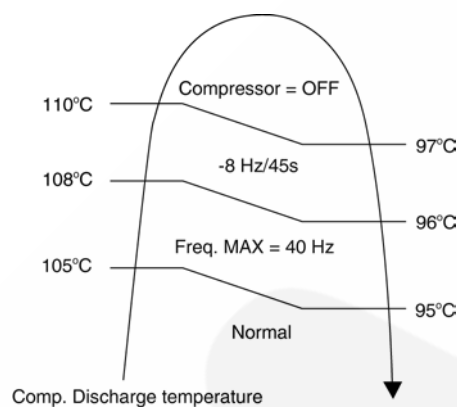

#### 12.2.1.6. Low Pressure Prevention Control (Gas Leakage Detection)

##### a. Control start conditions

- For 5 minutes, the compressor continuously operates and outdoor total current is between 0.65A and 1.65A.
- During Cooling and Soft Dry operations:  
Indoor suction temperature - indoor piping temperature is below 4°C.
- During Heating operations :  
Indoor piping temperature - indoor suction is under 5°C.

##### b. Control contents

- Compressor stops (and restart after 3 minutes).
- If the conditions above happen 2 times within 20 minutes, the unit will:
  - Stop operation
  - Timer LED blinks and "F91" indicated.

#### 12.2.1.7. Compressor Tank Temperature Rise Protection Control

##### a. Control start conditions

- For 5 minutes, the compressor continuously operates and outdoor total current is between 0.65A and 1.65A.
- During Cooling and Soft Dry operations:  
Indoor suction temperature - indoor piping temperature is below 4°C.  
Indoor temperature and outdoor temperature is 30±5°C.  
Remote Control setting 16°C and Hi Fan Speed.
- During Heating operations:  
Indoor piping temperature - indoor suction is under 5°C.  
Indoor temperature and outdoor temperature is 20 ± 2°C.  
Remote control setting 30°C and Hi Fan Speed.

b. Control contents

- Compressor stops (and restart after 3 minutes)
- If the conditions above happen 2 times within 20 minutes, the unit will:
  - Stop operation
  - Timer LED blinks and “F91” indicated

**12.2.1.8. Low Frequency Protection Control 1**

When the compressor operate at frequency lower than 24 Hz continued for 20 minutes, the operation frequency will be changed to 23 Hz for 2 minutes.

**12.2.1.9. Low Frequency Protection Control 2**

When all the below conditions occur, minimum value (Freq. MIN) for the frequency instructed to compressor will change to 29 (E7GK) ~ 35 (E9GK, E12GK, E15GK) Hz for cooling mode operation and 35 (E9GK, E12GK, E15GK) ~ 44 (E7GK) Hz for heating mode operation.

Temperature, T, for:	Cooling/Soft Dry	Heating
Indoor intake air (°C)	T < 15 or T ≥ 30	—
Outdoor air (°C)	T < 16 or T ≥ 38	T < 4 or T ≥ 24
Indoor heat exchanger (°C)	T < 30	T ≥ 0

**12.2.2. Protection Control For Cooling & Soft Dry Operation**

**12.2.2.1. Outdoor Air Temperature Control**

The compressor operating frequency is regulated in accordance to the outdoor air temperature as shown in the diagram below. This control will begin 1 minute after the compressor starts.

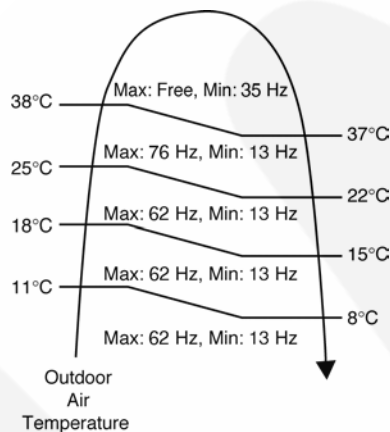

**12.2.2.2. Cooling Overload Control**

- Detects the Outdoor pipe temperature and carry out below restriction/limitation (Limit the compressor Operation frequency)
- The compressor stop if outdoor pipe temperature exceeds 61°C
- If the compressor stops 4 times in 20 minutes, Timer LED blinking (F95: outdoor high pressure rise protection)

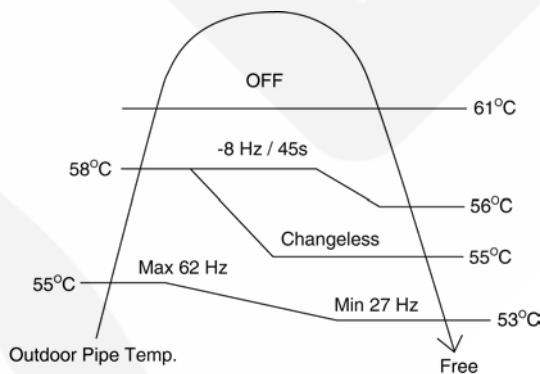



### 12.2.2.3. Freeze Prevention Control

1. When indoor heat exchanger temperature is lower than 0°C continuously for 6 minutes, compressor will stop operating.
2. Compressor will resume its operation 3 minutes after the indoor heat exchanger is higher than 13°C.
3. At the same time, indoor fan speed increase +20 rpm compared to its normal operation.
4. If indoor heat exchanger temperature is higher than 13°C for 5 minutes, the fan speed will return to its normal operation.

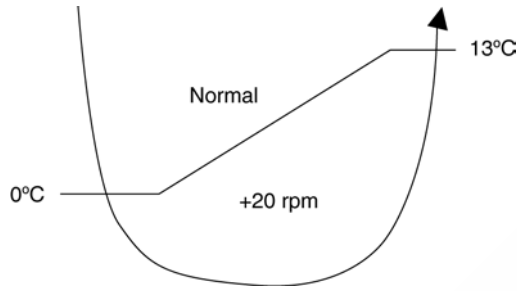

### 12.2.3. Protection Control For Heating Operation

#### 12.2.3.1. Intake Air Temperature Control

Compressor will operate at Max freq. if either one of the below conditions occur:

1. When the indoor intake air temperature is 30°C or above.

#### 12.2.3.2. Outdoor Air Temperature Control

The Max current value is regulated in accordance to the outdoor air temperature as shown in the below figures.

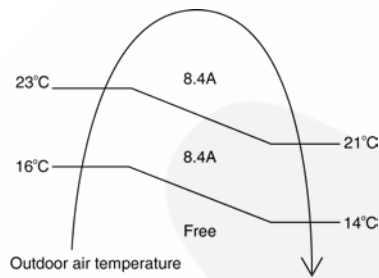

#### 12.2.3.3. Overload Protection Control

The compressor operating frequency is regulated in accordance to indoor heat exchanger temperature as shown in below figures.

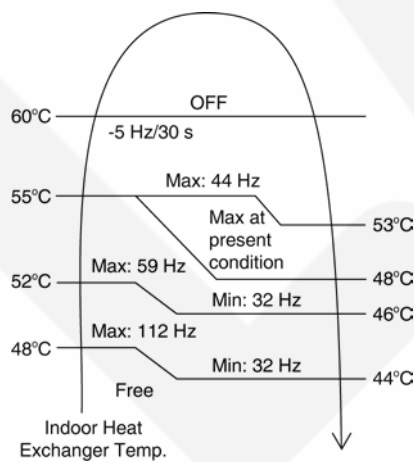

# 13 Servicing Mode

## 13.1. Auto OFF/ON Button

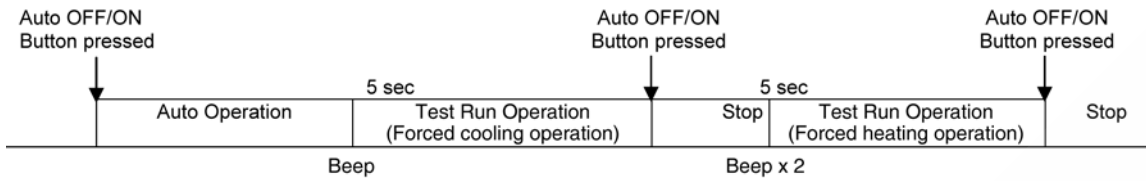

### 1. AUTO OPERATION MODE

The Auto operation will be activated immediately once the Auto OFF/ON button is pressed. This operation can be used to operate air conditioner with limited function if remote control is misplaced or malfunction.

### 2. TEST RUN OPERATION (FOR PUMP DOWN/SERVICING PURPOSE)

The Test Run operation will be activated if the Auto OFF/ON button is pressed continuously for more than 5 seconds. A “beep” sound will occur at the fifth seconds, in order to identify the starting of Test Run operation (Forced cooling operation). Within 5 minutes after Forced cooling operation start, the Auto OFF/ON button is pressed for more than 5 seconds. A 2 “beep” sounds will occur at the fifth seconds, in order to identify the starting of Forced heating operation.

The Auto OFF/ON button may be used together with remote control to set / change the advance setting of air conditioner operation.

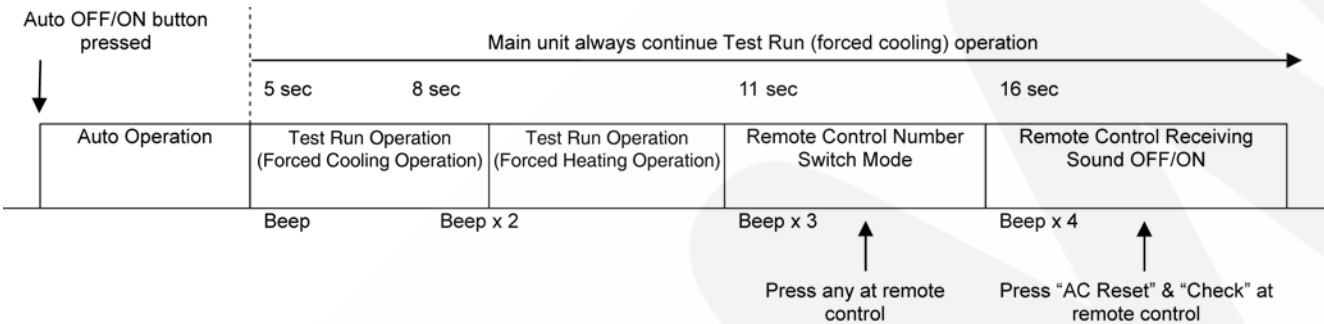

### 3. REMOTE CONTROL NUMBER SWITCH MODE

The Remote Control Number Switch Mode will be activated if the Auto OFF/ON button is pressed continuously for more than 11 seconds (3 “beep” sounds will occur at 11th seconds to identify the Remote Control Number Switch Mode is in standby condition) and press any button at remote control to transmit and store the desired transmission code to the EEPROM.

For transmission code selection explanation, please refer to “Select Remote Control Transmission Code”.

### 4. REMOTE CONTROL RECEIVING SOUND OFF/ON MODE

The Remote Control Receiving Sound OFF/ON Mode will be activated if the Auto OFF/ON button is pressed continuously for more than 16 seconds (4 “beep” sounds will occur at 16th seconds to identify the Remote Control Receiving Sound Off/On Mode is in standby condition) and press “AC Reset” button and then press “Check” button at remote control.

Press “Auto OFF/ON button” to toggle remote control receiving sound.

- Short “beep”: Turn OFF remote control receiving sound.
- Long “beep”: Turn ON remote control receiving sound.

After Auto OFF/ON Button is pressed, the 20 seconds counter for Remote Control Receiving Sound OFF/ON Mode is restarted.

## 13.2. Select Remote Control Transmission Code

- There are 4 types of remote control transmission code could be selected and stored in EEPROM of indoor unit. The indoor unit will only operate when received signal with same transmission code from remote control. This could prevent signal interference when there are 2 or more indoor units installed nearby together.
- To change remote control transmission code, short or open jumpers at the remote control printed circuit board.

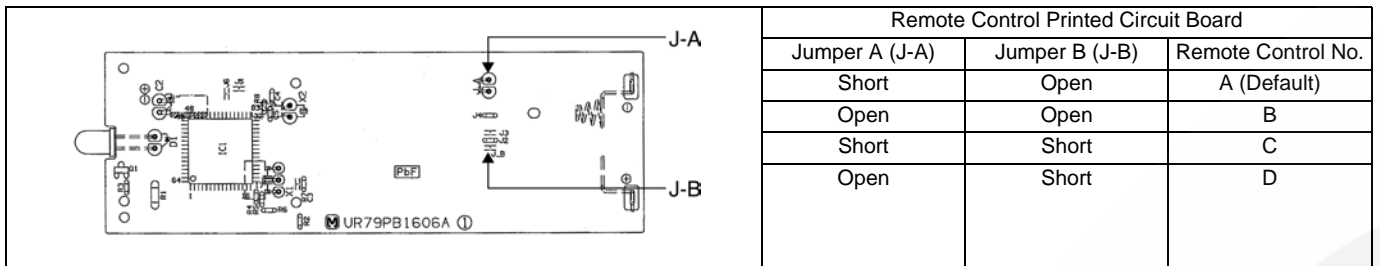

Remote Control Printed Circuit Board		
Jumper A (J-A)	Jumper B (J-B)	Remote Control No.
Short	Open	A (Default)
Open	Open	B
Short	Short	C
Open	Short	D

## 13.3. Remote Control Button

### 13.3.1. SET BUTTON

- To check current remote control transmission code
  - Press for more than 10 seconds.
- To change the air quality sensor sensitivity
  - Press and release with pointer.
  - Press the Timer Decrement button to select sensitivity:
    1. Low Sensitivity
    2. Standard (Default)
    3. Hi Sensitivity
  - Confirm setting by pressing Timer Set button, a “Beep” sound will be heard. LCD returns to original display after 2 seconds.
  - LCD returns to original display if remote control does not operate for 30 seconds.

### 13.3.2. CLOCK BUTTON

- To change the remote control's time format
  - Press for more than 5 seconds.

### 13.3.3. RESET (RC)

- To clear and restore the remote control setting to factory default
  - Press once to clear the memory.

### 13.3.4. RESET (AC)

- To restore the unit's setting to factory default
  - Press once to restore the unit's setting.

### 13.3.5. TIMER ▲

- To change indoor unit indicator's LED intensity
  - Press continuously for 5 seconds.

### 13.3.6. TIMER ▼

- To change remote control display from Degree Celsius to Degree Fahrenheit.
  - Press continuously for 10 seconds.

# 14 Troubleshooting Guide

## 14.1. Refrigeration Cycle System

In order to diagnose malfunctions, make sure that there are no electrical problems before inspecting the refrigeration cycle. Such problems include insufficient insulation, problem with the power source, malfunction of a compressor and a fan. The normal outlet air temperature and pressure of the refrigeration cycle depends on various conditions, the standard values for them are shown in the table on the right.

Normal Pressure and Outlet Air Temperature (Standard)

	Gas pressure MPa (kg/cm <sup>2</sup> G)	Outlet air temperature (°C)
Cooling Mode	0.9 ~ 1.2 (9 ~ 12)	12 ~ 16
Heating Mode	2.3 ~ 2.9 (23 ~ 29)	36 ~ 45

- ★ Condition:
- Indoor fan speed; High
  - Outdoor temperature 35°C at cooling mode and 7°C at heating mode.
  - Compressor operates at rated frequency

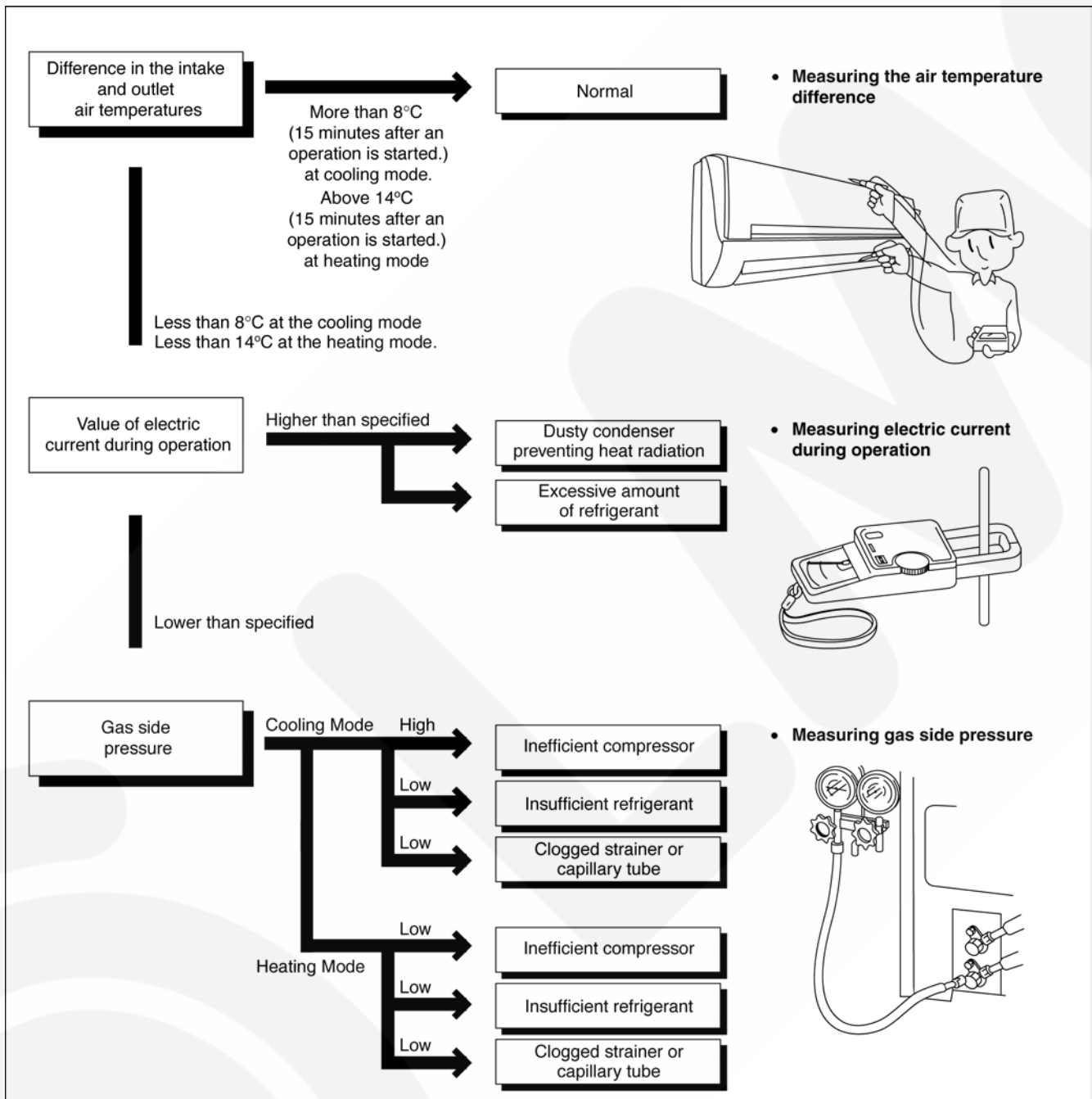

### 14.1.1. Relationship between the condition of the air conditioner and pressure and electric current

Condition of the air conditioner	Cooling Mode			Heating Mode		
	Low Pressure	High Pressure	Electric current during operating	Low Pressure	High Pressure	Electric current during operating
Insufficient refrigerant (gas leakage)	↘	↘	↘	↘	↘	↘
Clogged capillary tube or Strainer	↘	↘	↘	↘	↘	↘
Short circuit in the indoor unit	↘	↘	↘	↘	↘	↘
Heat radiation deficiency of the outdoor unit	↗	↗	↗	↘	↘	↘
Inefficient compression	↗	↘	↘	↘	↘	↘

- Carry out the measurements of pressure, electric current, and temperature fifteen minutes after an operation is started.

## 14.2. Breakdown Self Diagnosis Function

### 14.2.1. Self Diagnosis Function (Three Digits Alphanumeric Code)

- Once abnormality has occurred during operation, the unit will stop its operation, and Timer LED blinks.
- Although Timer LED goes off when power supply is turned off, if the unit is operated under a breakdown condition, the LED will light up again.
- In operation after breakdown repair, the Timer LED will no more blink. The last error code (abnormality) will be stored in IC memory.

#### • To make a diagnosis

1. Timer LED start to blink and the unit automatically stops the operation.
2. Press the CHECK button on the remote controller continuously for 5 seconds.
3. “- -” will be displayed on the remote controller display.  
Note: Display only for “- -”. (No transmitting signal, no receiving sound and no Power LED blinking.)
4. Press the “TIMER” ▲ or ▼ button on the remote controller. The code “H00” (no abnormality) will be displayed and signal will be transmitted to the main unit.
5. Every press of the button (up or down) will increase abnormality numbers and transmit abnormality code signal to the main unit.
6. When the latest abnormality code on the main unit and code transmitted from the remote controller are matched, power LED will light up for 30 seconds and a beep sound (continuously for 4 seconds) will be heard. If no codes are matched, power LED will light up for 0.5 seconds and no sound will be heard.
7. The breakdown diagnosis mode will be canceled unless pressing the CHECK button continuously for 5 seconds or operating the unit for 30 seconds.
8. The LED will be off if the unit is turned off or the RESET button on the main unit is pressed.

#### • To display memorized error (Protective operation) status

1. Turn power on.
2. Press the CHECK button on the remote controller continuously for 5 seconds.
3. “- -” will be displayed on the remote controller display.  
Note: Display only for “- -”. (No transmitting signal, no receiving sound and no Power LED blinking.)
4. Press the “TIMER” ▲ or ▼ button on the remote controller. The code “H00” (no abnormality) will be displayed and signal will be transmitted to the main unit. The power LED lights up. If no abnormality is stored in the memory, three beeps sound will be heard.
5. Every press of the button (up or down) will increase abnormality numbers and transmit abnormality code signal to the main unit.
6. When the latest abnormality code on the main unit and code transmitted from the remote controller are matched, power LED will light up for 30 seconds and a beep sound (continuously for 4 seconds) will be heard. If no codes are matched, power LED will light up for 0.5 seconds and no sound will be heard.

7. The breakdown diagnosis mode will be canceled unless pressing the CHECK button continuously for 5 seconds or operating the unit for 30 seconds.
8. The same diagnosis can be repeated by turning power on again.

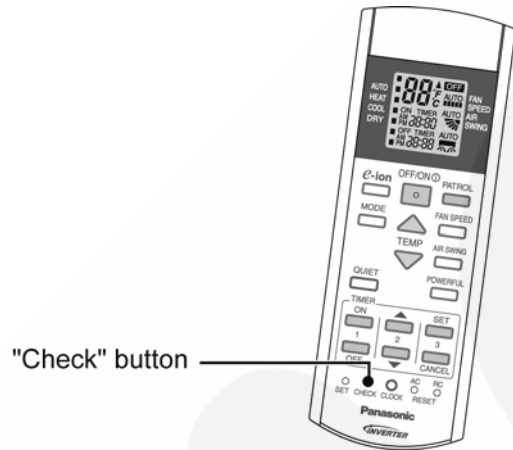

#### • To clear memorized error (Protective operation) status after repair:

1. Turn power on.
2. Press the AUTO button for 5 seconds (A beep receiving sound) on the main unit to operate the unit at Forced Cooling Operation modes.
3. Press the CHECK button on the remote controller for about 1 second with a pointed object to transmit signal to main unit. A beep sound is heard from main unit and the data is cleared.

#### • Temporary Operation (Depending on breakdown status)

1. Press the AUTO button (A beep receiving sound) on the main unit to operate the unit. (Remote control will become possible.)
2. The unit can temporarily be used until repaired.

Error Code	Operation	Temporary items
H23	Cooling	Emergency Operation with limited power
H27, H28	Cooling, Heating	

### 14.3. Error Codes Table

Diagnosis display	Abnormality / Protection control	Abnormality Judgement	Emergency operation	Primary location to verify
H00	No abnormality detected	—	Normal operation	
H11	Indoor / outdoor abnormal communication	> 1 min after starting operation	Indoor fan operation only	<ul style="list-style-type: none"> <li>Internal / external cable connections</li> <li>Indoor / Outdoor PCB</li> </ul>
H12	Connection capability rank abnormal	—	—	—
H14	Indoor intake air temperature sensor abnormality	Continue for 5 sec.	—	<ul style="list-style-type: none"> <li>Intake air temperature sensor (detective or disconnected)</li> </ul>
H15	Outdoor compressor temperature sensor abnormality	Continue for 5 sec.	—	<ul style="list-style-type: none"> <li>Compressor temperature sensor (detective or disconnected)</li> </ul>
H16	Outdoor Current Transformer open circuit	—	—	<ul style="list-style-type: none"> <li>Outdoor PCB</li> <li>IPM (Power transistor) module</li> </ul>
H19	Indoor fan motor mechanism lock	7 times occurrence continuously.	—	<ul style="list-style-type: none"> <li>Indoor PCB</li> <li>Fan motor</li> </ul>
H23	Indoor heat exchanger temperature sensor abnormality	Continue for 5 sec.	O (Cooling only)	<ul style="list-style-type: none"> <li>Heat exchanger temperature sensor (defective or disconnected)</li> </ul>
H25	E-Ion breakdown	—	—	<ul style="list-style-type: none"> <li>Indoor PCB</li> <li>E-Ion PCB</li> </ul>
H27	Outdoor air temperature sensor abnormality	Continue for 5 sec.	O	<ul style="list-style-type: none"> <li>Outdoor temperature sensor (defective or disconnected)</li> </ul>
H28	Outdoor heat exchanger temperature sensor abnormality	Continue for 5 sec.	O	<ul style="list-style-type: none"> <li>Outdoor heat exchanger temperature sensor (defective or disconnected)</li> </ul>
H33	Indoor/Outdoor wrong connection	—	—	<ul style="list-style-type: none"> <li>Indoor/Outdoor supply voltage</li> </ul>
H38	Indoor/outdoor mismatch (brand code)	—	—	—
H58	Abnormal gas sensor	Continue for 6 hours	—	<ul style="list-style-type: none"> <li>Gas sensor (defective or disconnected)</li> </ul>
H98	Indoor high pressure protection	—	—	<ul style="list-style-type: none"> <li>Air filter dirty</li> <li>Air circulation short circuit</li> </ul>
H99	Indoor heat exchanger anti-freezing protection	—	—	<ul style="list-style-type: none"> <li>Insufficient refrigerant</li> <li>Air filter dirty</li> </ul>
F11	Cooling / Heating cycle changeover abnormality	4 times occurrence within 30 minutes	—	<ul style="list-style-type: none"> <li>4-way valve</li> <li>V-coil</li> </ul>
F90	PFC control	4 times occurrence within 20 minutes	—	<ul style="list-style-type: none"> <li>Voltage at PFC</li> </ul>
F91	Refrigeration cycle abnormal	2 times occurrence within 20 minutes	—	<ul style="list-style-type: none"> <li>No refrigerant (3-way valve is closed)</li> </ul>
F93	Outdoor compressor abnormal revolution	4 times occurrence within 20 minutes	—	<ul style="list-style-type: none"> <li>Outdoor compressor</li> </ul>
F95	Cool high pressure protection	4 times occurrence within 20 minutes	—	<ul style="list-style-type: none"> <li>Outdoor refrigerant circuit</li> </ul>
F96	IPM (power transistor) overheating protection	—	—	<ul style="list-style-type: none"> <li>Excess refrigerant</li> <li>Improper heat radiation</li> <li>IPM (Power transistor)</li> </ul>
F97	Outdoor compressor overheating protection	4 times occurrence within 20 minutes	—	<ul style="list-style-type: none"> <li>Insufficient refrigerant</li> <li>Compressor</li> </ul>
F98	Total running current protection	3 times occurrence within 20 minutes	—	<ul style="list-style-type: none"> <li>Excess refrigerant</li> <li>Improper heat radiation</li> </ul>
F99	Outdoor Direct Current (DC) peak detection	7 times occurrence continuously	—	<ul style="list-style-type: none"> <li>Outdoor PCB</li> <li>IPM (Power transistor)</li> <li>Compressor</li> </ul>

Note:

“O” - Frequency measured and fan speed fixed.

The memory data of error code is erased when the power supply is cut off, or press the Auto Switch until “beep” sound heard following by pressing the “CHECK” button at Remote Control.

Although operation forced to stop when abnormality detected, emergency operation is possible for certain errors (refer to Error Codes Table) by using Remote Control or Auto Switch at indoor unit. However, the Remote Control signal receiving sound is changed from one “beep” to four “beep” sounds.

# 15 Disassembly and Assembly Instructions

## WARNING

High voltages are generated in the electrical parts area by the capacitor. Ensure that the capacitor has discharged sufficiently before proceeding with repair work. Failure to heed this caution may result in electric shocks.

### 15.1. Indoor Electronic Controllers, Cross Flow Fan and Indoor Fan Motor Removal Procedures

#### 15.1.1. To remove the Front Grille

- Lift to open the vertical vent gently. Remove the 2 caps and 2 screws at the bottom of discharge vent. (Fig. 1)
- Remove the Front Grille by releasing the 3 hooks at the top of the Front Grille. Hold both sides of the Front Grille and remove it by pulling up and towards you gently. (Fig. 1)

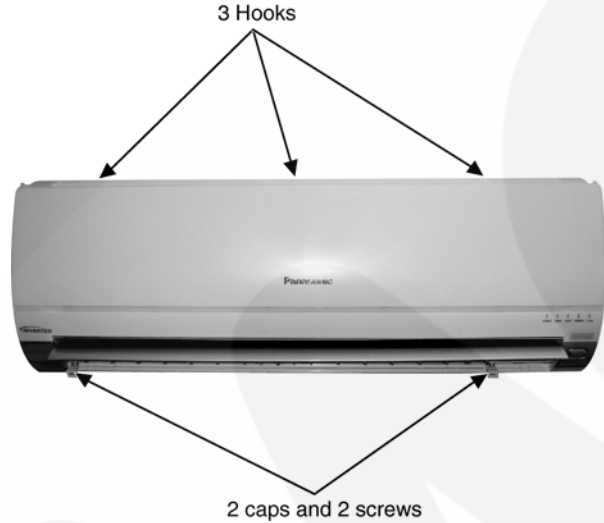

Fig. 1

#### 15.1.2. To remove the Main Electronic Controller

- Unhook the tabs at the Control Board to remove the Control Board Cover. (Fig. 2)

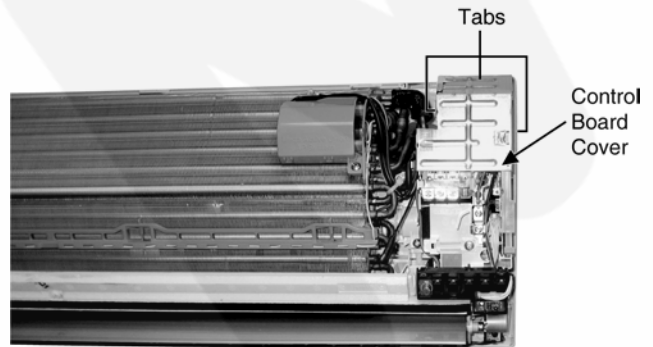

Fig. 2

- Release the Indicator by detaching the CN-DISP and CN-LED, then remove the Indicator from the 2 tabs. (Fig. 3)

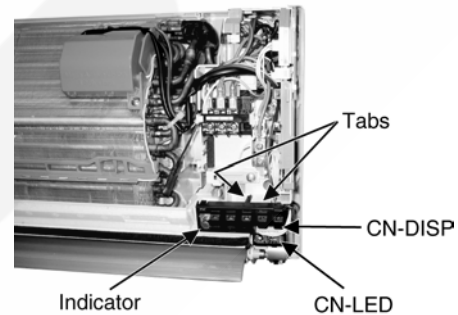

Fig. 3



- Press the Hold to the right side, remove the Particular Piece and slide out the Main Electronic Controller (Fig. 4).

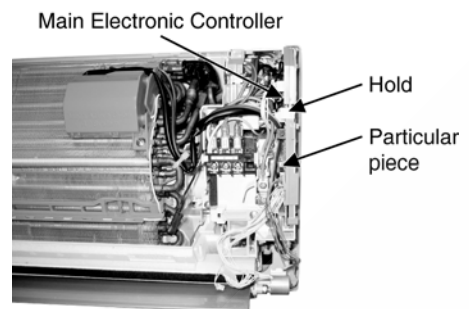

Fig. 4

- Release the CN-DATA1. (Fig. 5)
- Release the CN-CLN. (Fig.5)
- Release the CN-FB (for S12GK only). (Fig.5)
- Release the CN-TH. (Fig.5)
- Release the CN-STM1. (Fig.5)

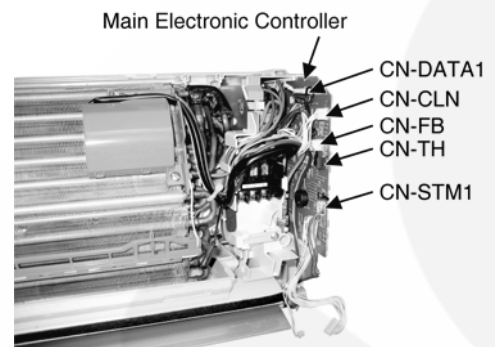

Fig. 5

### 15.1.3. To remove the Power Electronic Controller

- Release the screw for the Earth wire. (Fig. 6)
- Pull out 2 terminal wires (Black and Red) from the Terminal Board. (Fig. 6)
- Detach the Terminal Board from the Control Board. (Fig. 6)
- Press the Hold to the left side, remove the Particular Piece and slide out the Power Electronic Controller. (Fig. 6)

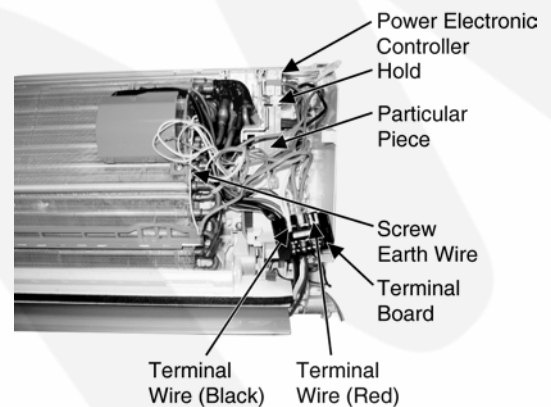

Fig. 6

- Release the AC-301 (BRW) connector. (Fig. 7)
- Release the AC-303 (WHT) connector. (Fig. 7)
- Release the CN-PCFM connector. (Fig. 7)

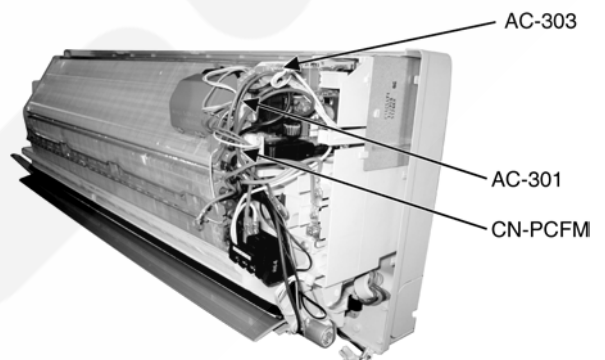

Fig. 7

#### 15.1.4. To remove the Discharge Grille

- Pull out the Drain Hose (behind the Discharge Grille) from outlet to remove the Discharge Grille. (Fig. 8)

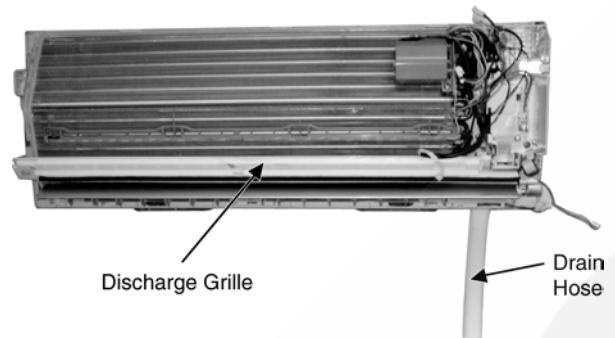

Fig. 8

#### 15.1.5. To remove the Control Board

- Release the 3 screws. (Fig. 9)
- By pressing down the hook at the left side of Control Board, you will be able to remove the Control Board. (Fig. 9)

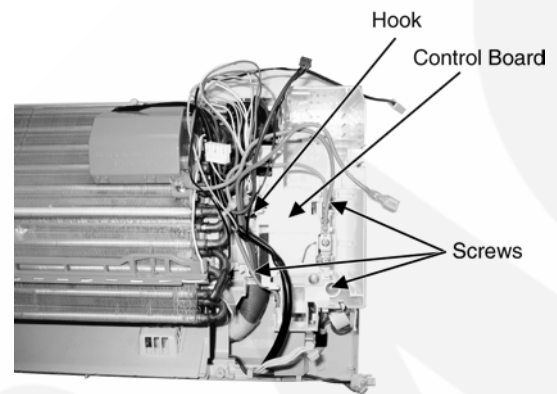

Fig. 9

#### 15.1.6. To remove the Cross Flow Fan and Indoor Fan Motor

- Remove the screw at the Cross Flow Fan. (Fig 10)
- Reminder:- To reinstall the Fan Motor, please adjust the connector location to 45° with Fan Motor before fixing Control Board. (Fig. 10)

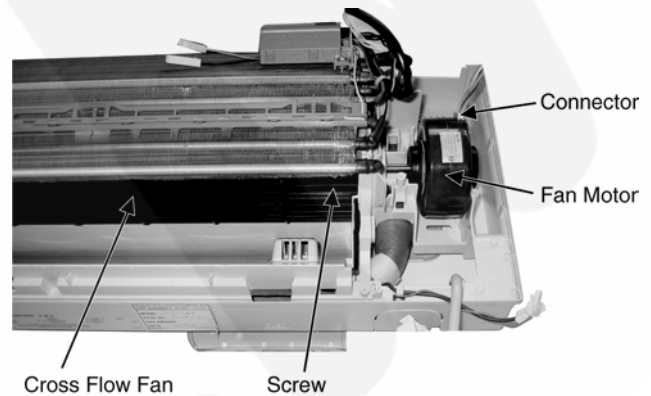

Fig. 10

- Remove the Bearing. (Fig. 11)
- Remove the screw at the left of the Evaporator. (Fig. 11)
- Press the Hold to the left side then you can release the Evaporator. (Fig. 11)

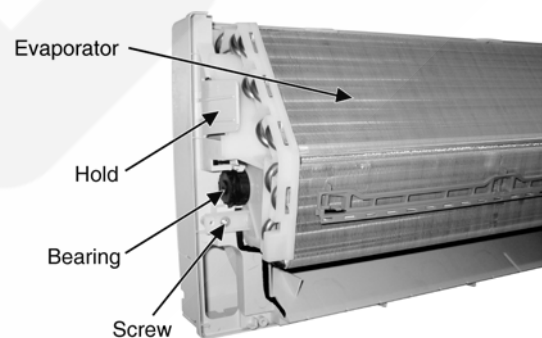

Fig. 11

- Lift up the Evaporator and remove the Cross Flow Fan from the unit by pulling it to the left and downward. Fan Motor can be removed after the removal of the Cross Flow Fan (Fig. 12)

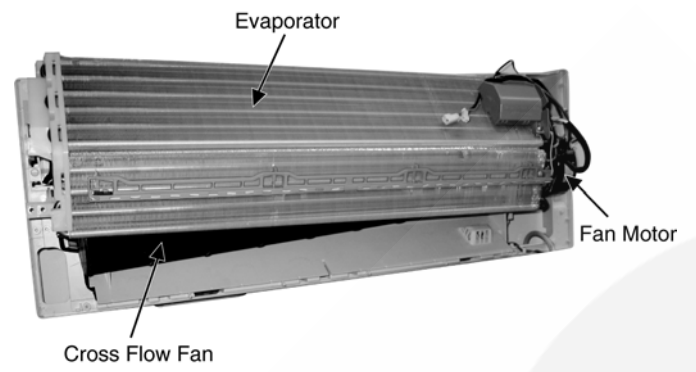

Fig. 12

## 15.2. Outdoor Electronic Controller Removal Procedure

**⚠ Caution!** When handling electronic controller, be careful of electrostatic discharge.

1. Remove the 3 screws of the Top Panel.

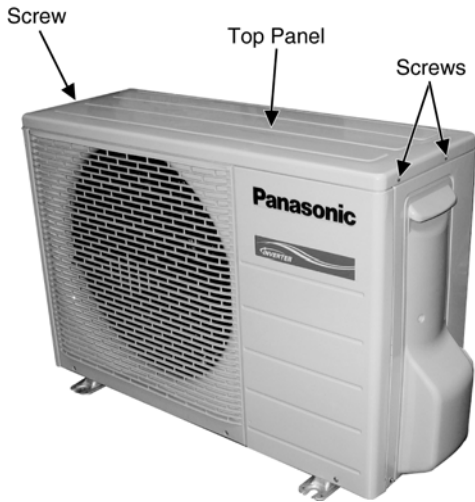

Fig. 1

2. Remove the 6 screws of the Front Panel.

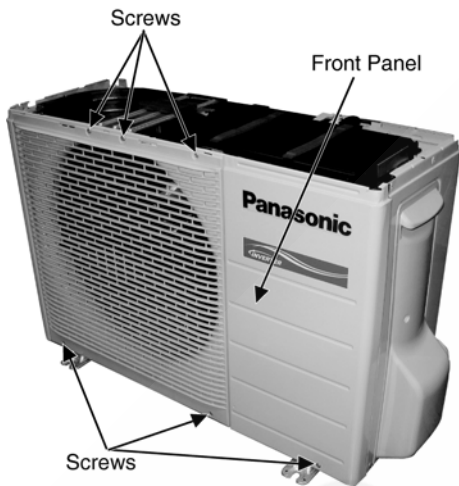

Fig. 2

3. Remove the screw of the Terminal Board Cover.

4. Remove the Top Cover of the Control Board by 4 hooks.

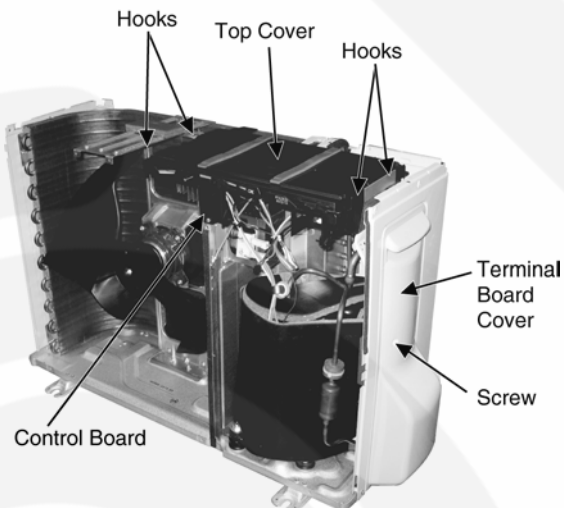

Fig. 3

5. Remove the Control Board as follows:

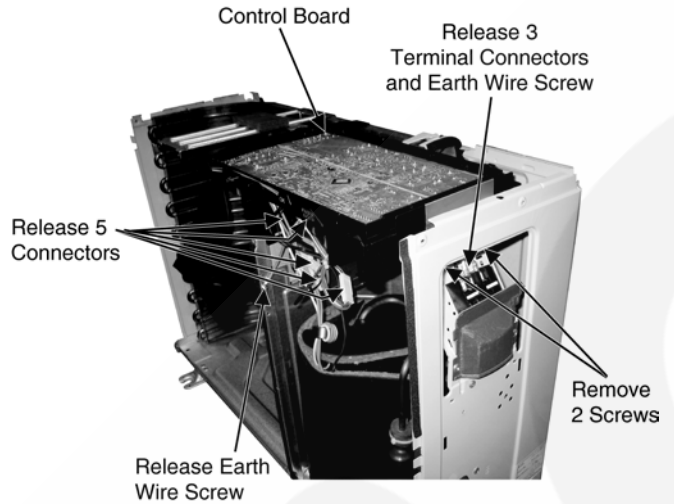

Fig. 4

Remove the Terminal Cover and 3 Terminal Compressor

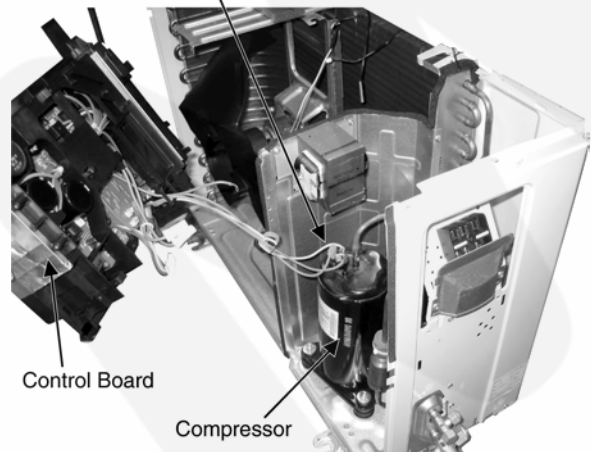

Fig. 5

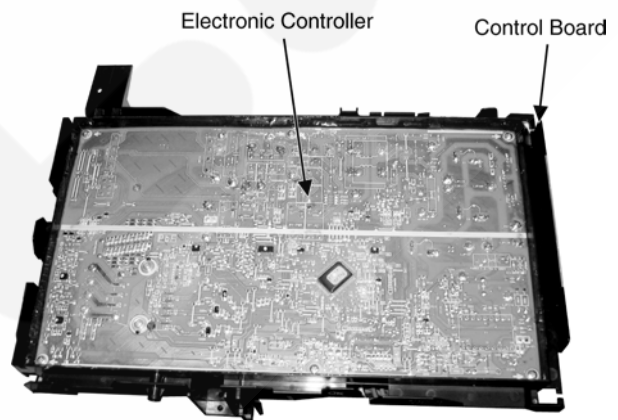

Fig. 6

# 16 Technical Data

## 16.1. Operation Characteristics

### 16.1.1. CS-E9GKEW-5 CU-E9GKE-5

#### • Cooling Characteristic

[Condition] Room temperature: 27/19°C

Operation condition: High fan speed (Rated Frequency)

Piping length: 7.5 m

◆ 220V  
 ◆ 230V  
 ▲ 240V

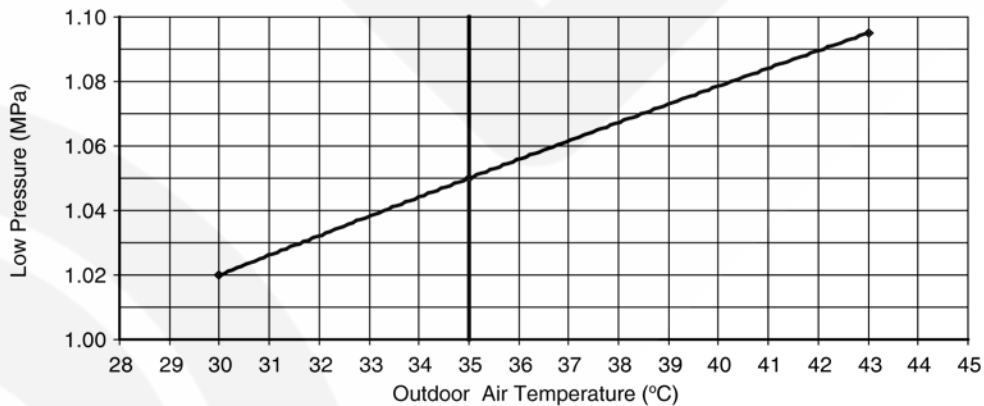
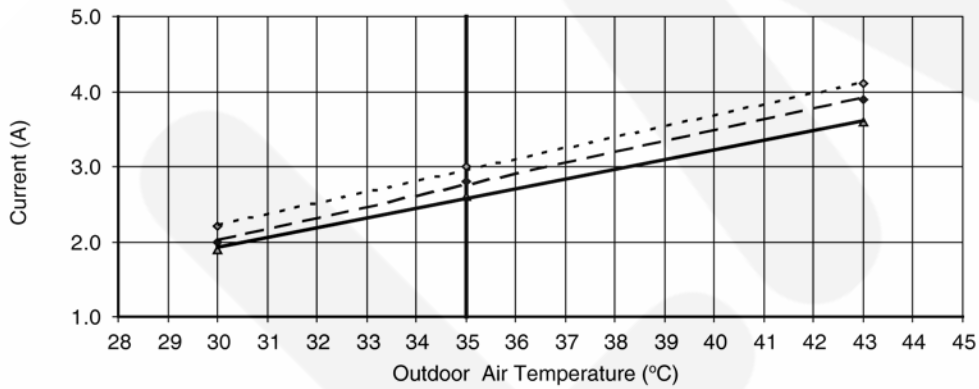
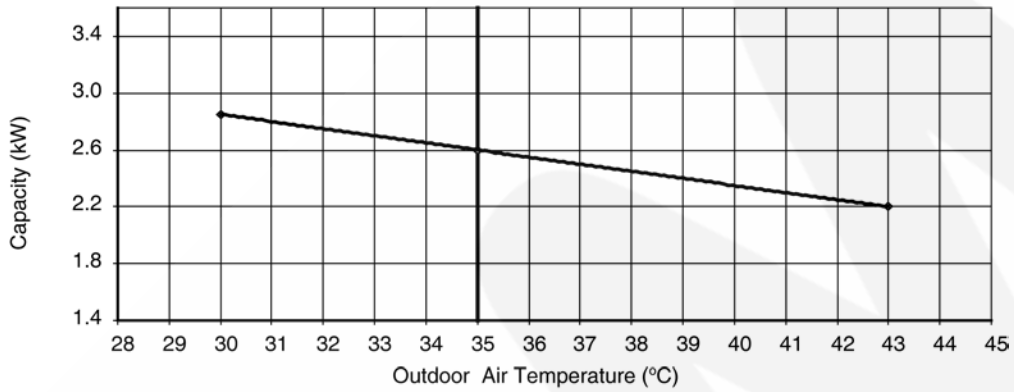
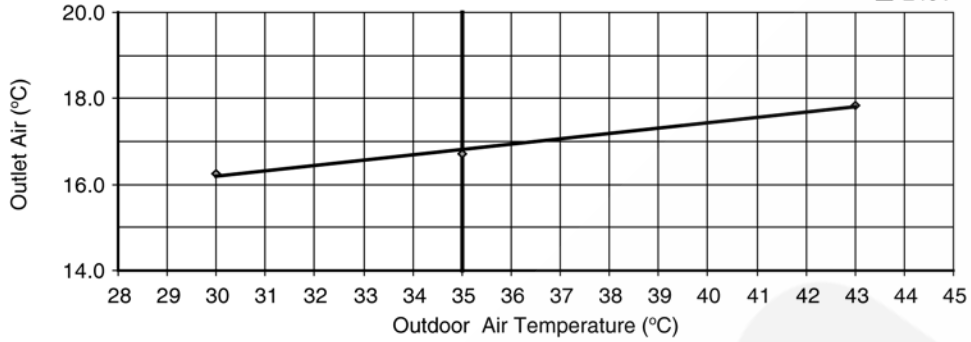

## • Piping Length Characteristic

[Condition] Room temperature: 27/19°C

Operation condition: High fan speed (Rated Frequency)

Outdoor temperature: 35/24°C

▲ 220V  
◆ 230V  
■ 240V

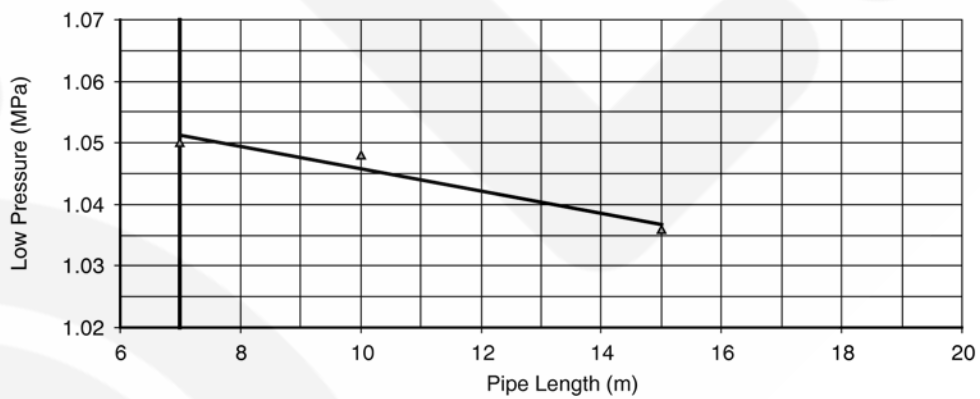
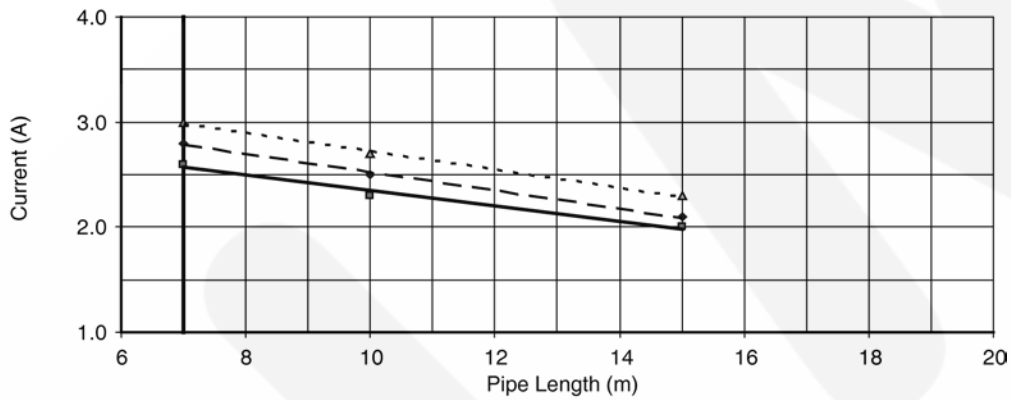
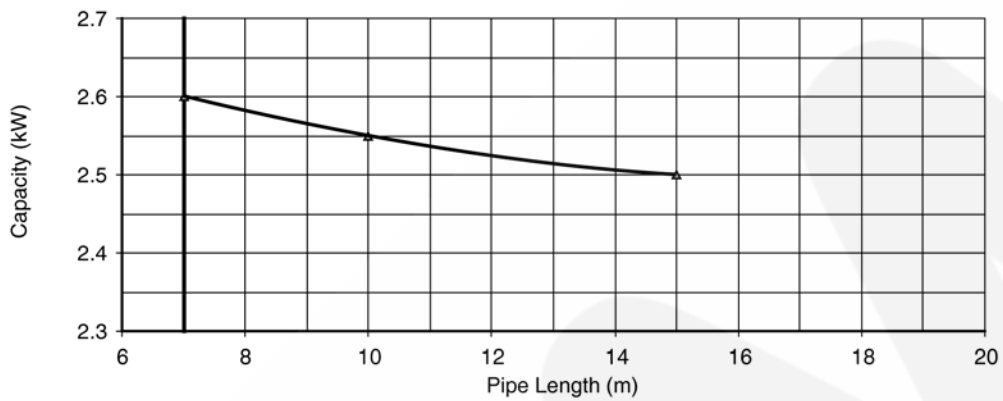
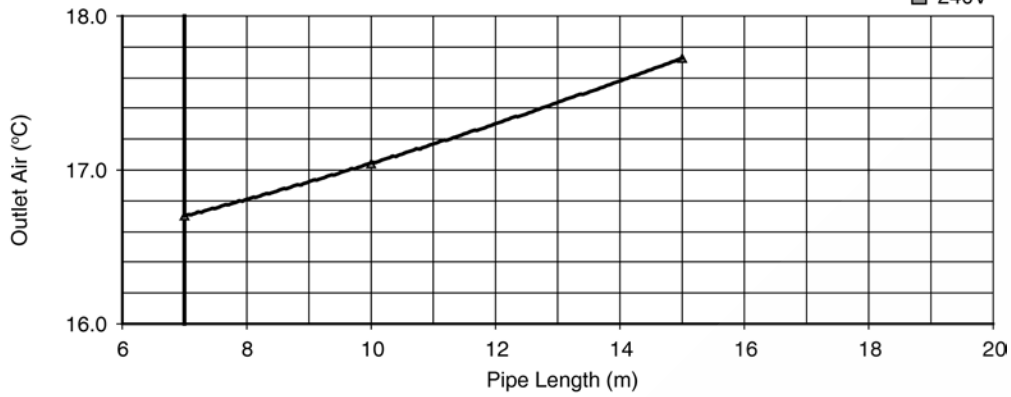

## • Heating Characteristic

[Condition] Room temperature: 20/-°C

Operation condition: High fan speed (Rated Frequency)

Piping length: 7.5 m

▲ 220V  
◆ 230V  
■ 240V

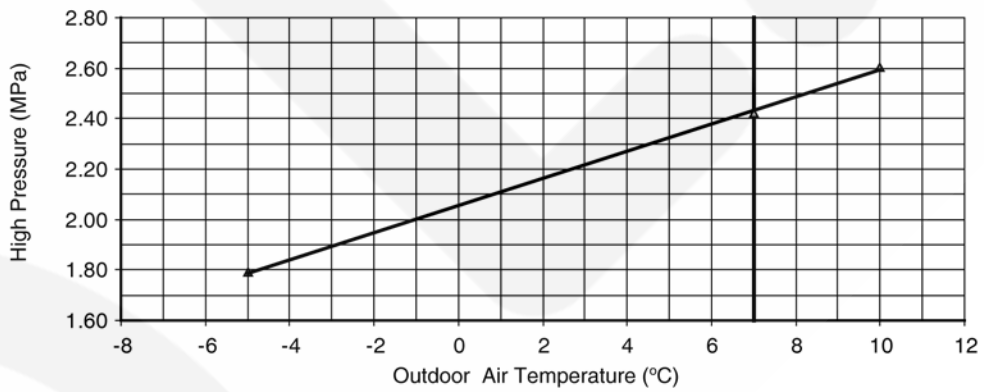
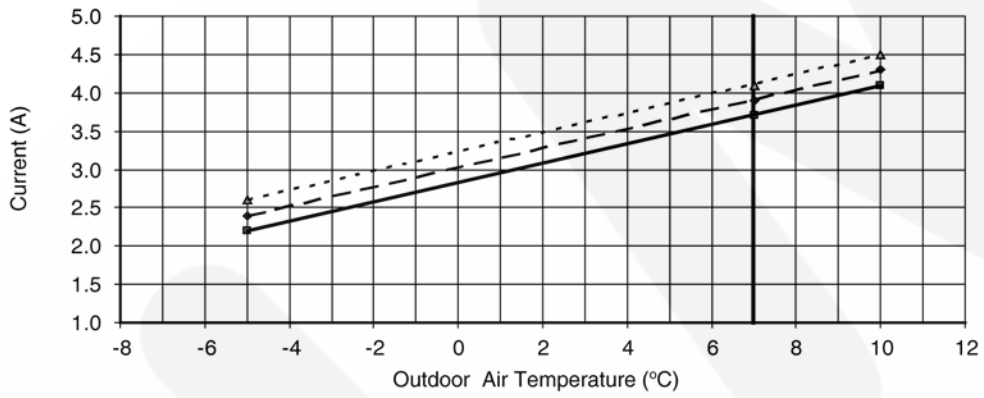
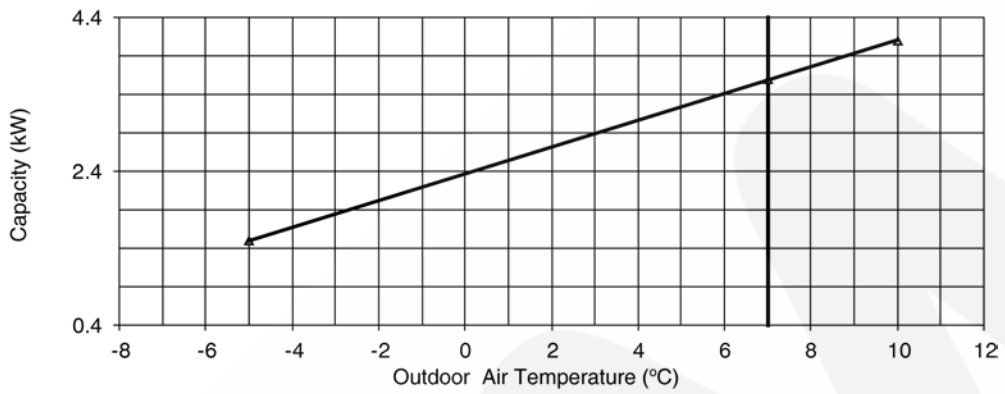
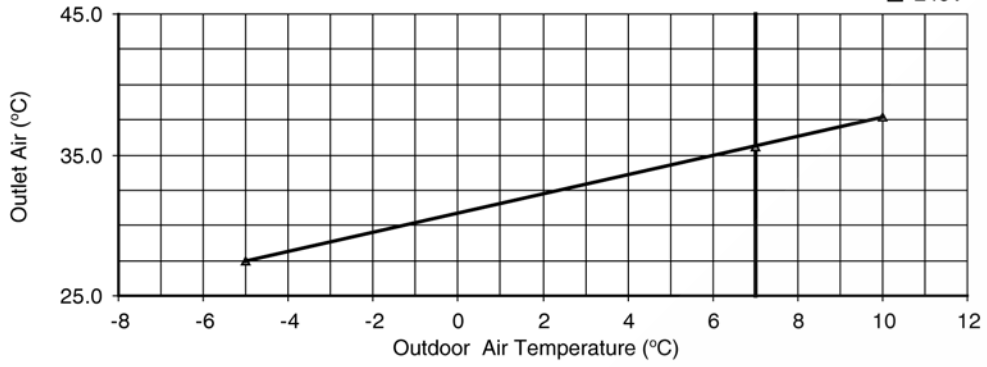

## • Piping Length Characteristic

[Condition] Room temperature: 20/-°C

Operation condition: High fan speed (Rated Frequency)

Outdoor temperature: 35/24°C

▲ 220V  
◆ 230V  
■ 240V

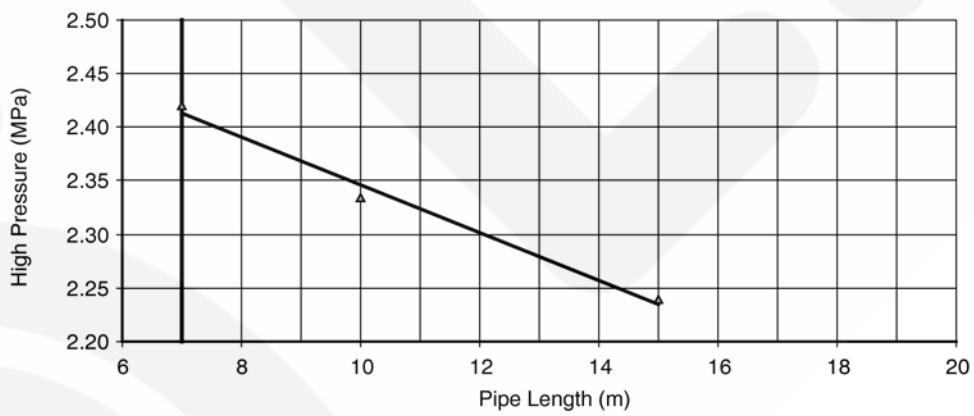
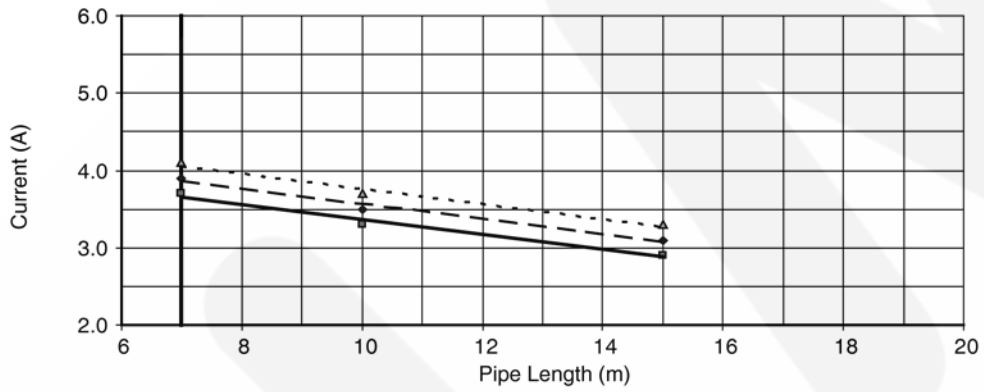
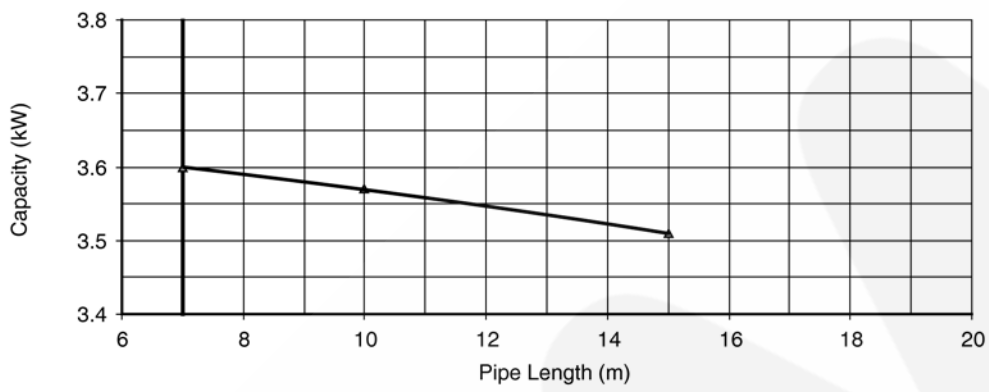
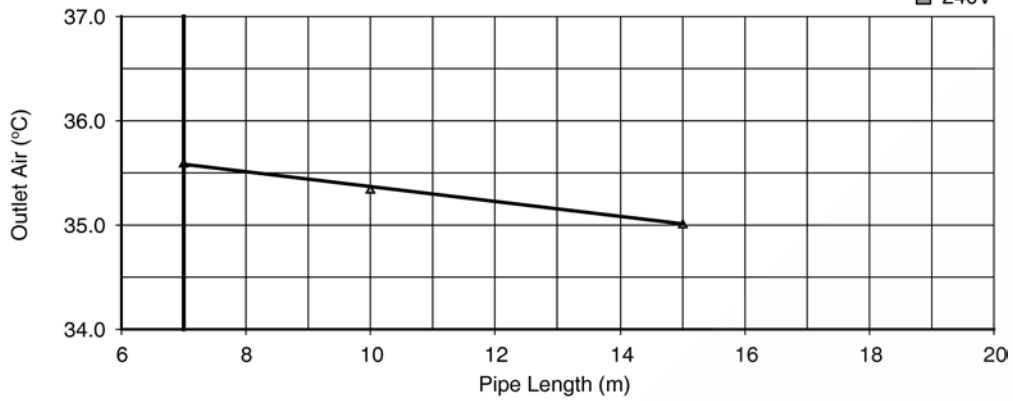



## 16.1.2. CS-E12GKEW-5 CU-E12GKE-5

### • Cooling Characteristic

[Condition] Room temperature: 27/19°C

Operation condition: High fan speed (Rated Frequency)

Piping length: 7.5 m

◆ 220V  
 ◆ 230V  
 ▲ 240V

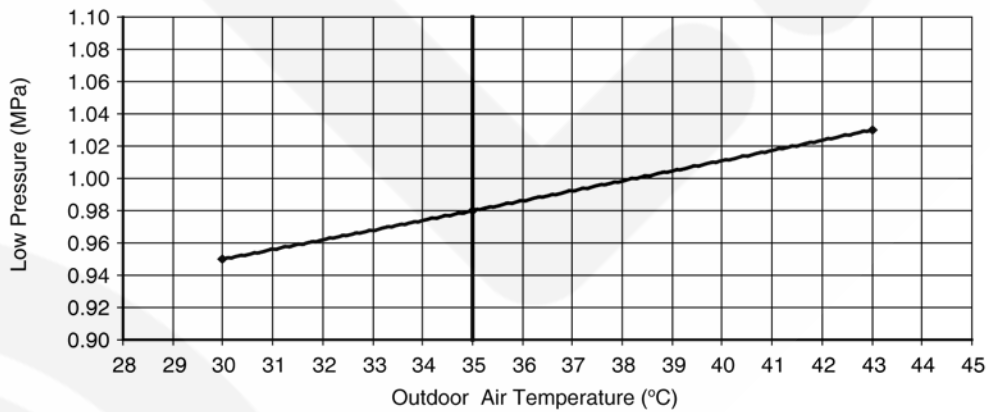
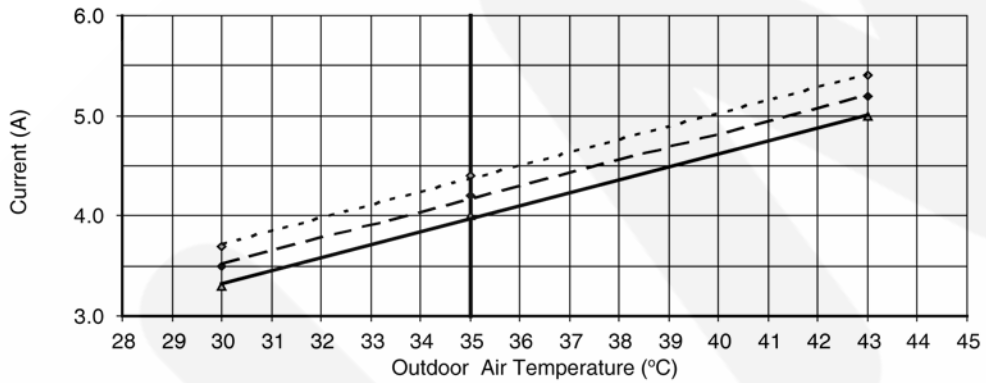
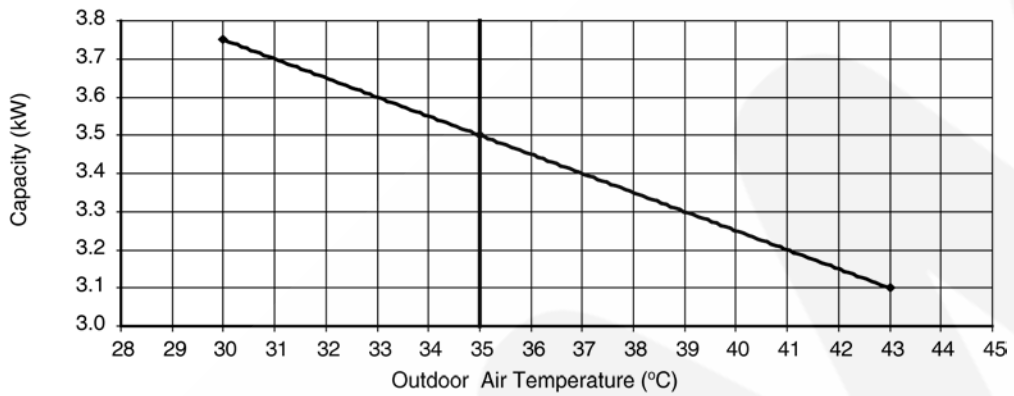
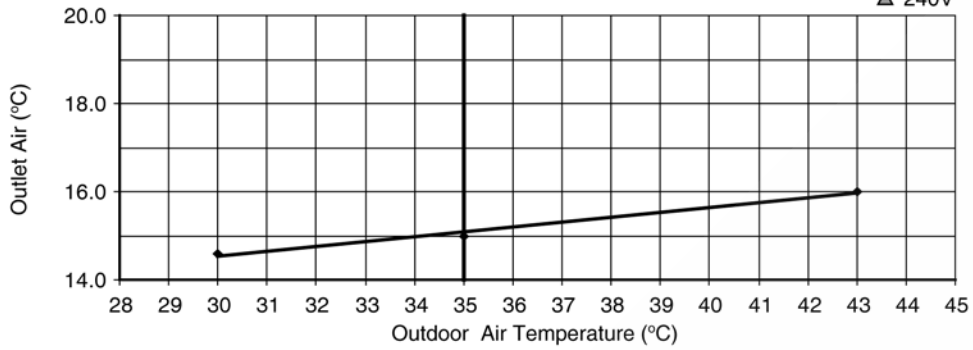

# • Piping Length Characteristic

[Condition] Room temperature: 27/19°C  
 Operation condition: High fan speed (Rated Frequency)  
 Outdoor temperature: 35/24°C

▲ 220V  
 ◆ 230V  
 ■ 240V

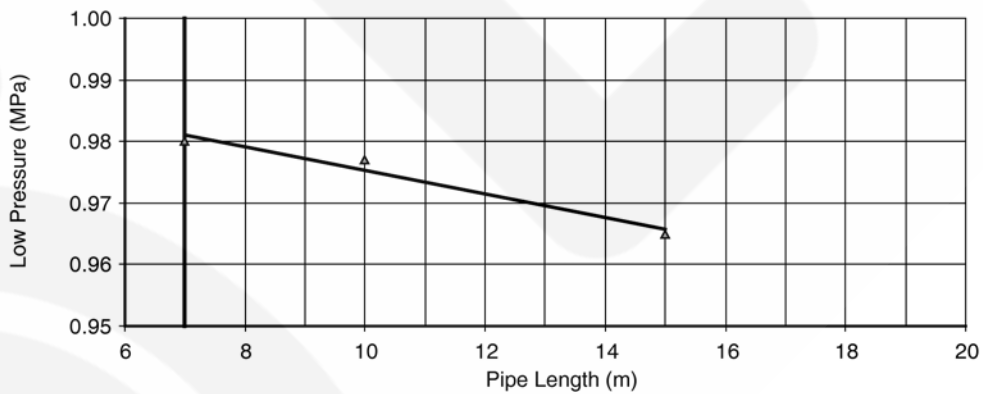
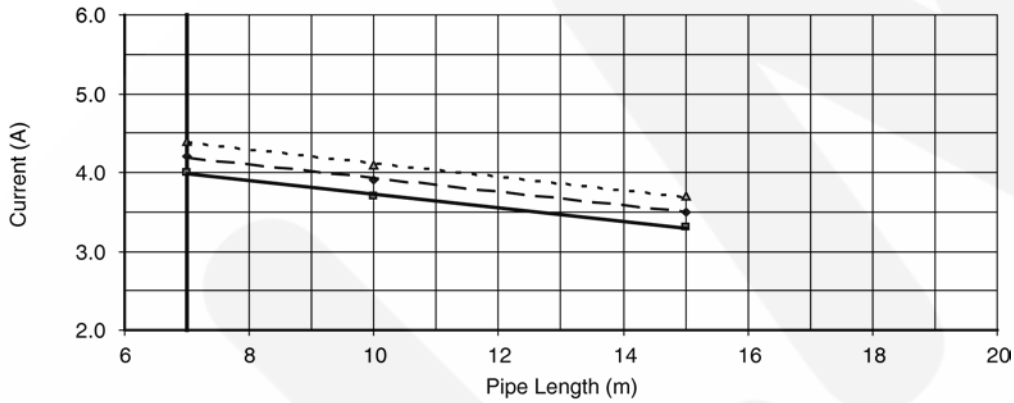
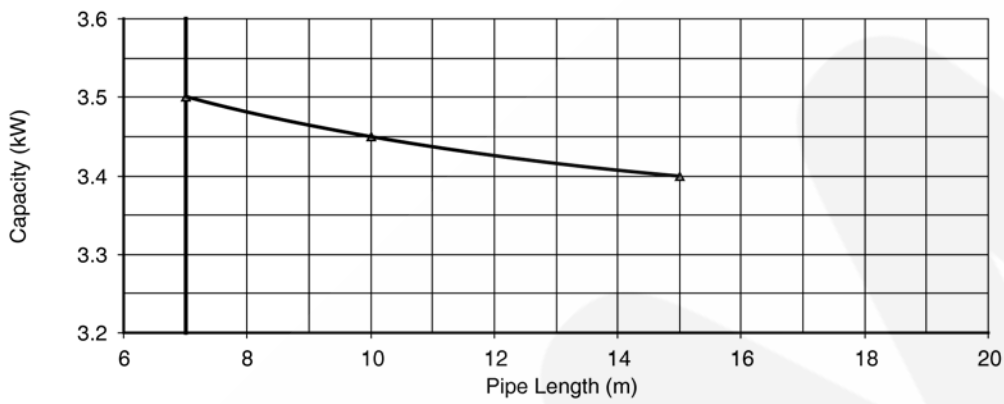
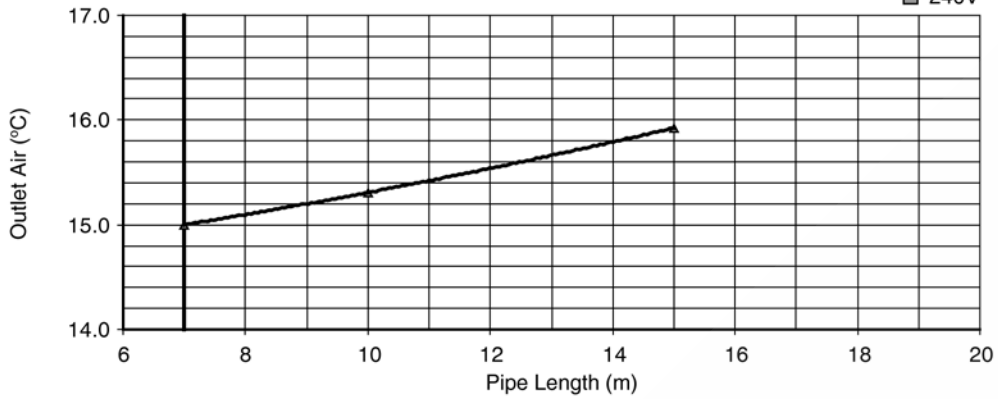

## • Heating Characteristic

[Condition] Room temperature: 20/-°C

Operation condition: High fan speed (Rated Frequency)

Piping length: 7.5 m

▲ 220V  
◆ 230V  
■ 240V

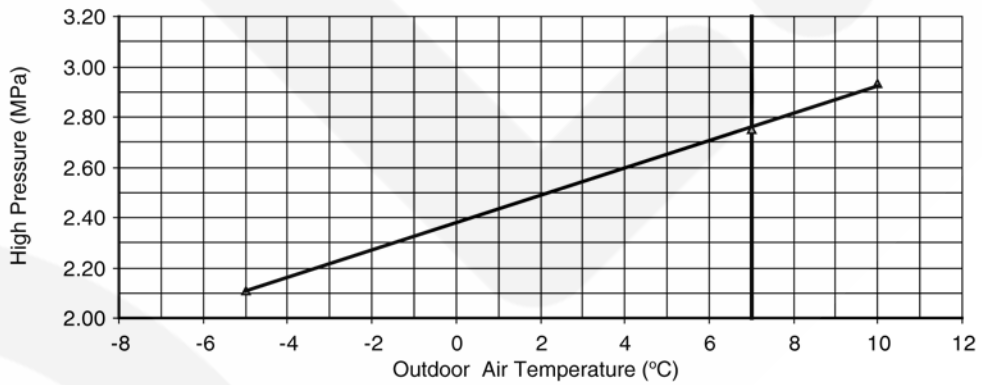
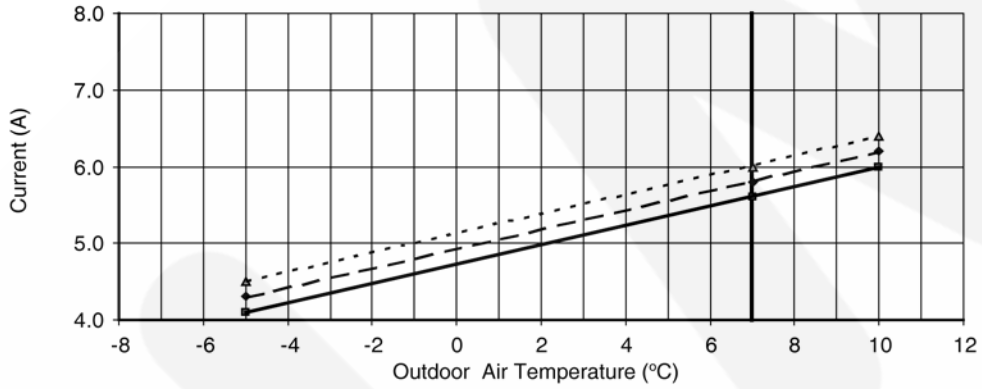
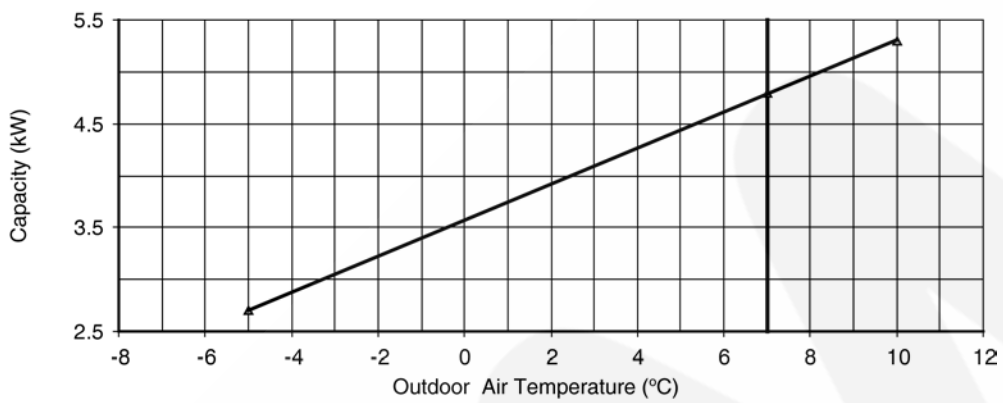
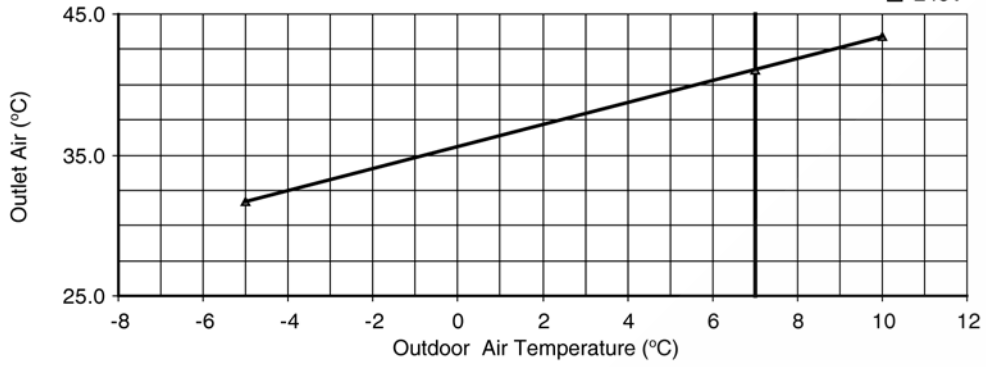

## • Piping Length Characteristic

[Condition] Room temperature: 20/-°C

Operation condition: High fan speed (Rated Frequency)

Outdoor temperature: 35/24°C

▲ 220V  
◆ 230V  
■ 240V

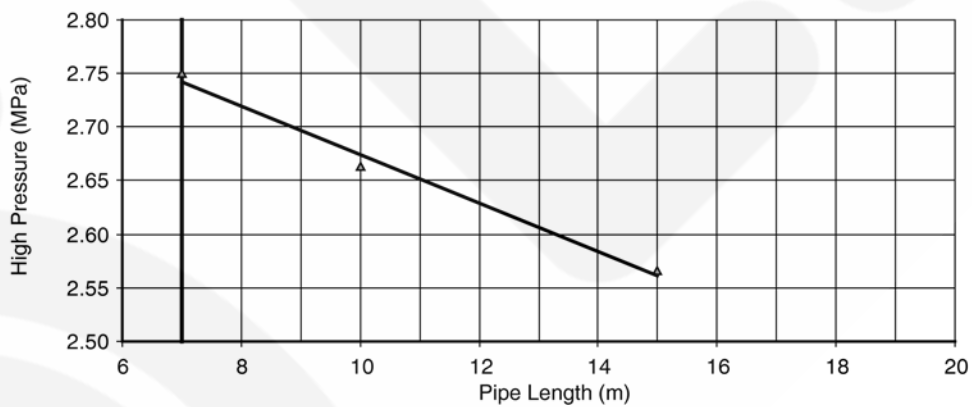
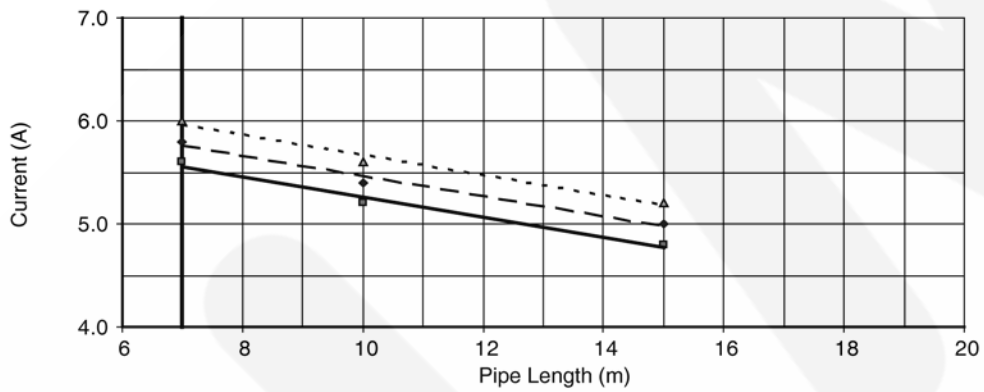
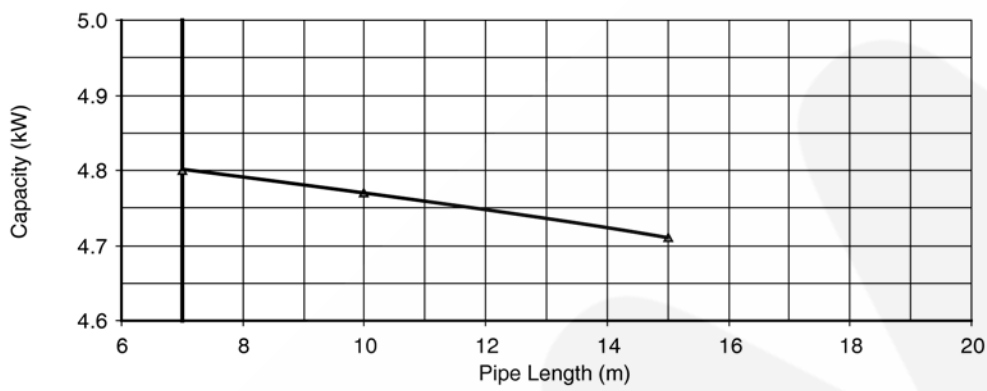
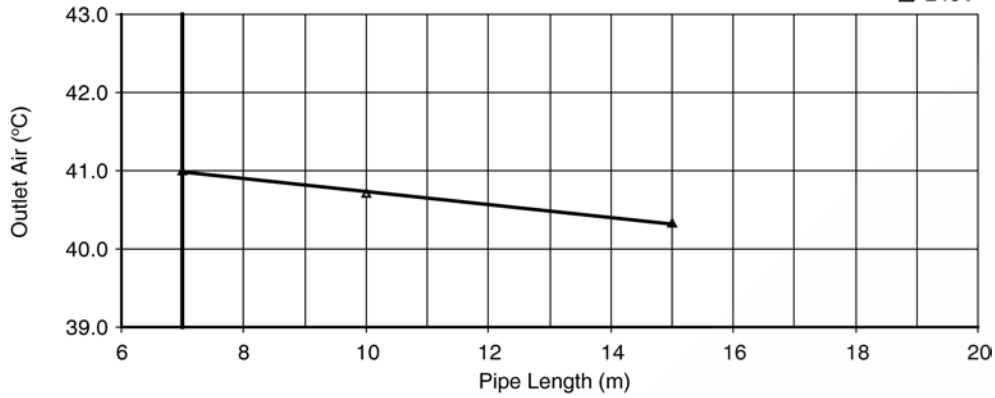

## 16.2. Sensible Capacity Chart

### ● CS-E9GKEW-5 CU-E9GKE-5

230V	Outdoor Temp. (°C)											
Indoor wet bulb temp.	30			35			40			46		
	TC	SHC	IP	TC	SHC	IP	TC	SHC	IP	TC	SHC	IP
17.0°C	2.58	1.96	0.54	2.41	1.88	0.58	2.24	1.80	0.62	2.04	1.71	0.67
19.0°C				2.60		0.59						
19.5°C	2.83	2.05	0.55	2.65	1.97	0.59	2.46	1.89	0.63	2.24	1.80	0.68
22.0°C	3.09	2.12	0.56	2.88	2.04	0.60	2.68	1.97	0.64	2.44	1.88	0.70

### ● CS-E12GKEW-5 CU-E12GKE-5

230V	Outdoor Temp. (°C)											
Indoor wet bulb temp.	30			35			40			46		
	TC	SHC	IP	TC	SHC	IP	TC	SHC	IP	TC	SHC	IP
17.0°C	3.47	2.63	0.84	3.24	2.52	0.91	3.02	2.43	0.97	2.74	2.30	1.05
19.0°C				3.50		0.92						
19.5°C	3.81	2.76	0.86	3.56	2.65	0.92	3.31	2.55	0.99	3.01	2.43	1.07
22.0°C	4.15	2.86	0.87	3.88	2.75	0.94	3.61	2.65	1.01	3.28	2.53	1.08

TC - Total Cooling Capacity (kW)  
 SHC - Sensible Heat Capacity (kW)  
 IP - Input Power (kW)

Indoor 27°C/19°C  
 Outdoor 35°C/24°C

# 17 Exploded View and Replacement Parts List

## 17.1. Indoor Unit

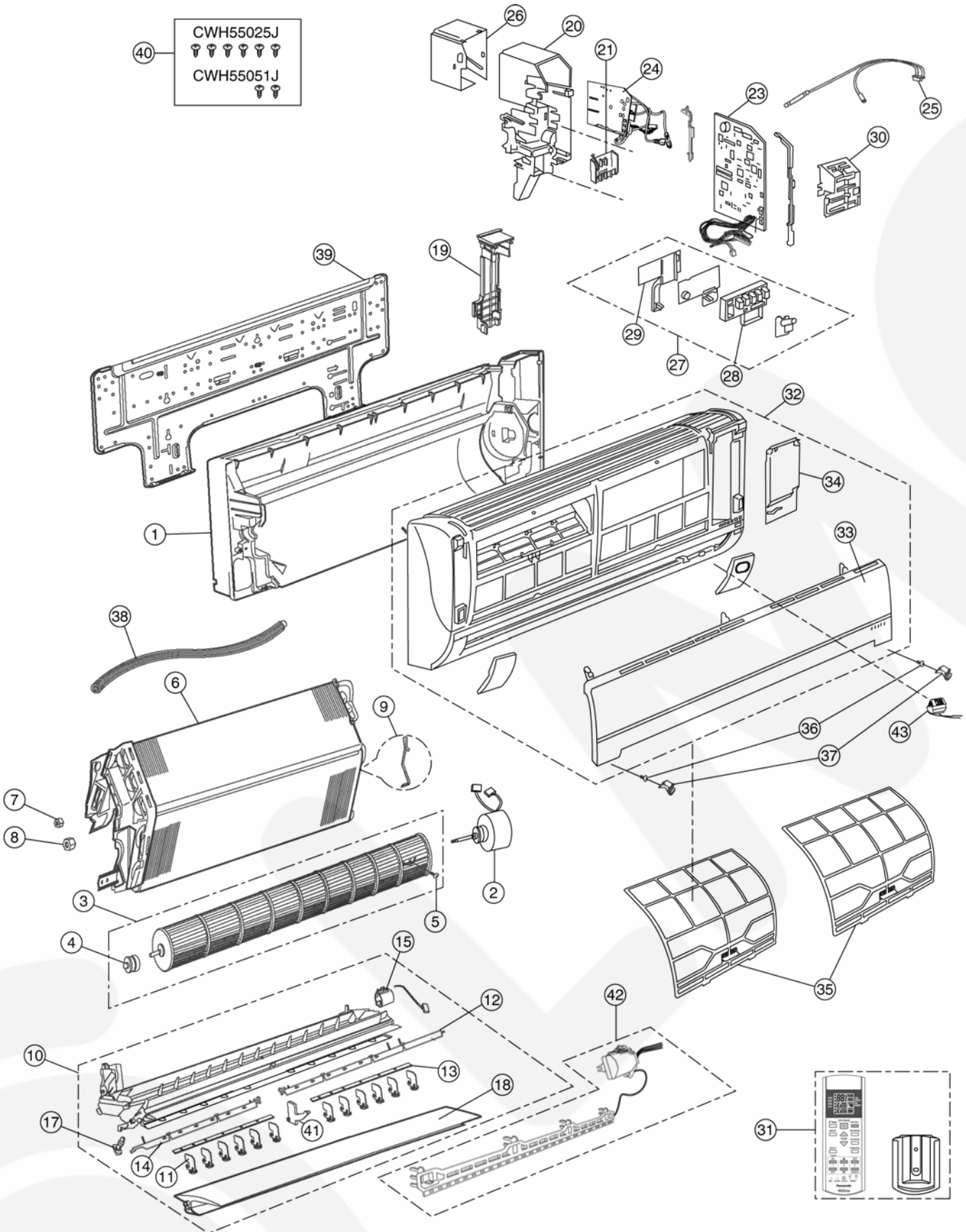

**Note**  
 The above exploded view is for the purpose of parts disassembly and replacement.  
 The non-numbered parts are not kept as standard service parts.

REF. NO.	PART NAME & DESCRIPTION	QTY.	CS-E9GKEW-5	CS-E12GKEW-5	REMARKS
1	CHASSY COMPLETE	1	CWD50C1513	←	
2	FAN MOTOR	1	ARW61F8P30AC	←	O
3	CROSS FLOW FAN COMPLETE	1	CWH02C1045	←	
4	BEARING ASSY	1	CWH64K007	←	
5	SCREW - CROSS FLOW FAN	1	CWH551146	←	
6	EVAPORATOR	1	CWB30C2099	CWB30C2115	
7	FLARE NUT (1/4")	1	CWT251030	←	
8	FLARE NUT (3/8")	1	CWT251031	CWT251032	
9	CLIP FOR SENSOR	1	CWH32143	←	
10	DISCHARGE GRILLE COMPLETE	1	CWE20C2621	←	
11	VERTICAL VANE	12	CWE241157	←	
12	CONNECTING BAR	1	CWE261092	←	
13	CONNECTING BAR	2	CWE261071	←	
14	CONNECTING BAR	1	CWE261091	←	
15	AIR SWING MOTOR	1	CWA981091	←	O
17	CAP - DRAIN TRAY	1	CWH521096	←	
18	HORIZONTAL VANE COMPLETE	1	CWE24C1176	←	
19	BACK COVER CHASSIS	1	CWD932454	←	
20	CONTROL BOARD CASING	1	CWH102321	←	
21	TERMINAL BOARD COMPLETE	1	CWA28C2128J	←	O
23	ELECTRONIC CONTROLLER - MAIN	1	CWA73C2533	CWA73C2534	O
24	ELECTRONIC CONTROLLER - POWER	1	CWA744567	←	O
25	SENSOR COMPLETE	1	CWA50C2122	←	O
26	CONTROL BOARD FRONT COVER	1	CWH131207	←	
27	INDICATOR COMPLETE	1	CWE39C1168	←	O
28	INDICATOR HOLDER	1	CWD932744	←	
29	INDICATOR HOLDER	1	CWD932745	←	
30	CONTROL BOARD FRONT COVER CO.	1	CWH13C1171	←	
31	REMOTE CONTROL COMPLETE	1	CWA75C3006	←	O
32	FRONT GRILLE COMPLETE	1	CWE11C3676	←	O
33	INTAKE GRILLE COMPLETE	1	CWE22C1344	←	
34	GRILLE DOOR	1	CWE14C1010	←	
35	E-ION FILTER	2	CWD00K1001	←	
36	SCREW - FRONT GRILLE	2	XTT4+16CFJ	←	
37	CAP - FRONT GRILLE	2	CWH521109	←	
38	DRAIN HOSE	1	CWH851063	←	
39	INSTALLATION PLATE	1	CWH361067	←	
40	BAG COMPLETE - INSTALLATION SCREW	1	CWH82C067	←	
41	FULCRUM	1	CWH621049	←	
42	E-ION AIR PURIFYING SYSTEM	1	CWH14C5332	←	O
43	ION - GENERATOR	1	CWH94C0014	←	O

(NOTE)

- All parts are supplied from PHAAM, Malaysia (Vendor Code: 061).
- "O" marked parts are recommended to be kept in stock.

## 17.2. Outdoor Unit

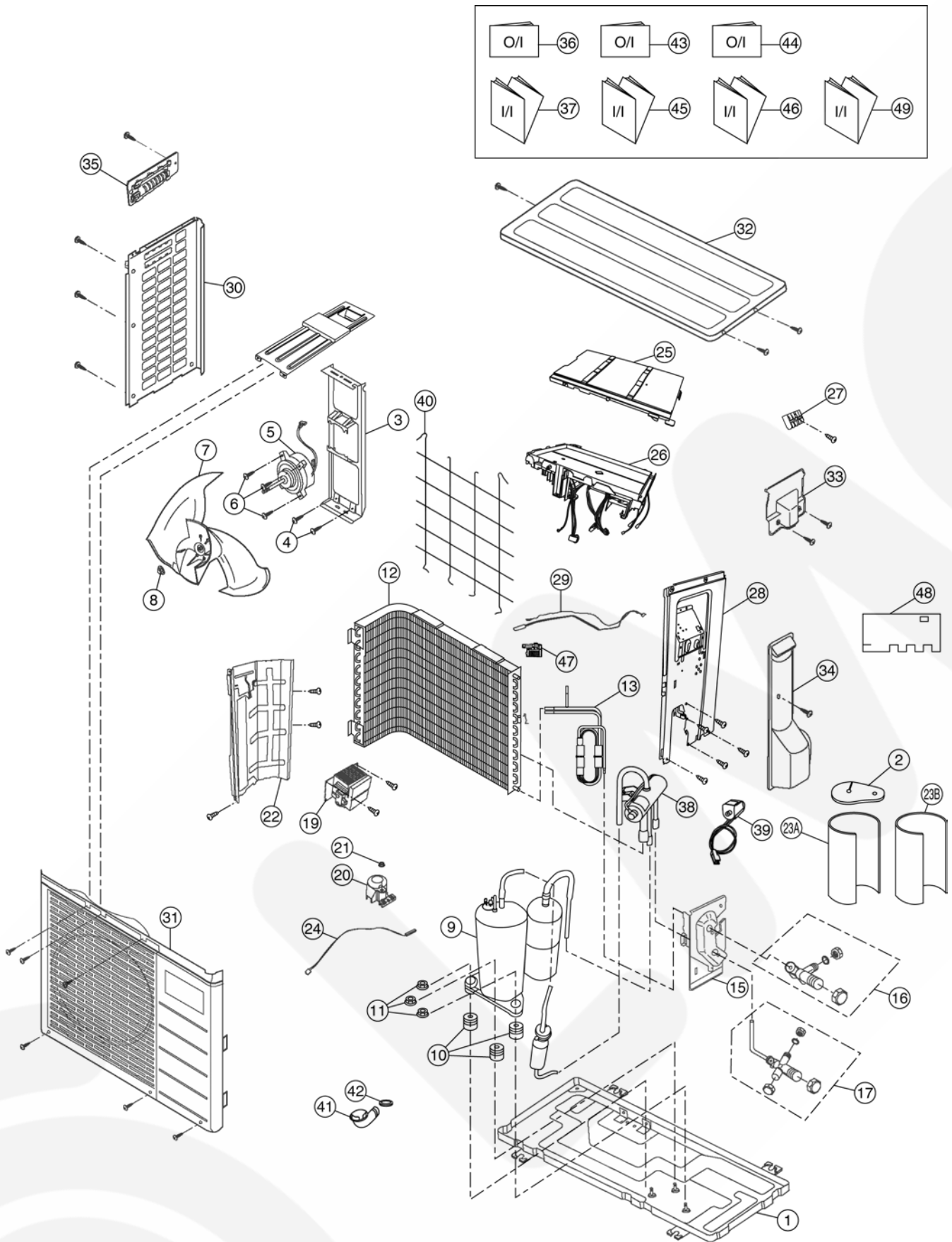

### Note

The above exploded view is for the purpose of parts disassembly and replacement.  
The non-numbered parts are not kept as standard service parts.



REF. NO.	PART NAME & DESCRIPTION	QTY.	CU-E9GKE-5	CU-E12GKE-5	REMARKS
1	CHASSY ASS'Y	1	CWD50K2073	←	
2	SOUND PROOF MATERIAL	1	CWG302314	←	
3	FAN MOTOR BRACKET	1	CWD541030	←	
4	SCREW - FAN MOTOR BRACKET	2	CWH551198	←	
5	FAN MOTOR	1	CWA951553	CWA951542	O
6	SCREW - FAN MOTOR MOUNT	3	CWH55252J	CWH55406J	
7	PROPELLER FAN ASS'Y	1	CWH03K1010	←	
8	NUT - PROPELLER FAN	1	CWH56053J	←	
9	COMPRESSOR	1	5RS102XBC01	←	O
10	ANTI - VIBRATION BUSHING	3	CWH50077	←	
11	NUT - COMPRESSOR MOUNT	3	CWH56000J	←	
12	CONDENSER	1	CWB32C1599	←	
13	TUBE ASS'Y CO. (CAP. / CHK VALVE)	1	CWT01C3257	CWT01C3258	
15	HOLDER COUPLING	1	CWH351023	←	
16	2-WAYS VALVE (LIQUID)	1	CWB021301	←	O
17	3-WAYS VALVE (GAS)	1	CWB011374	CWB011367	O
19	REACTOR	1	CWA421084	G0A193M00001	O
20	TERMINAL COVER	1	CWH171039A	←	
21	NUT - TERMINAL COVER	1	CWH7080300J	←	
22	SOUND PROOF BOARD	1	CWH151172	←	
23A	SOUND PROOF MATERIAL	1	CWG302316	←	
23B	SOUND PROOF MATERIAL	1	CWG302317	←	
24	SENSOR COMPLETE	1	CWA50C2205	←	O
25	CONTROL BOARD COVER	1	CWH131264	←	
26	ELECTRONIC CONTROLLER - MAIN	1	CWA73C2542R	CWA73C2714R	O
27	TERMINAL BOARD ASS'Y	1	CWA28K1110J	←	O
28	CABINET SIDE PLATE CO.	1	CWE04C1116	←	
29	SENSOR COMPLETE	1	CWA50C2391	←	O
30	CABINET SIDE PLATE	1	CWE041248A	←	
31	CABINET FRONT PLATE CO.	1	CWE06C1136	←	
32	CABINET TOP PLATE	1	CWE031014A	←	
33	PLATE - C. B. COVER	1	CWH131301	←	
34	CONTROL BOARD COVER CO.	1	CWH13C1064	←	
35	HANDLE	1	CWE161010	←	
36	OPERATION INSTRUCTIONS (ENG., FRA., ESP.)	1	CWF565488	←	
37	INSTALLATION INSTRUCTION (ENG., ESP., FRA., DEU.)	1	CWF613077	←	
38	4-WAYS VALVE	1	CWB001037J	←	O
39	V - COIL COMPLETE	1	CWA43C2143J	←	O
40	WIRE NET	1	CWD041111A	←	
41	L - TUBE	1	CWH5850080	←	
42	PACKING - L. TUBE	1	CWB81012	←	
43	OPERATION INSTRUCTIONS (DEU., ITA., NED.)	1	CWF565489	←	
44	OPERATION INSTRUCTIONS (POR., GRE., BUL.)	1	CWF565583	←	
45	INSTALLATION INSTRUCTION (NED., GRE., ITA., POR.)	1	CWF613078	←	
46	INSTALLATION INSTRUCTION (BUL.)	1	CWF613082	←	
47	HOLDER SENSOR	1	CWH321023	←	
48	SOUND PROOF MATERIAL	1	CWG302315	←	
49	INSTALLATION INSTRUCTION	1	CWF613079	←	

(NOTE)

- All parts are supplied from PHAAM, Malaysia (Vendor Code: 061).
- "O" marked parts are recommended to be kept in stock.