

# Service Manual

## Air Conditioner

*Simplified*

**CS-CE7GKEW CU-CE7GKE**  
**CS-CE9GKEW CU-CE9GKE**  
**CS-CE12GKEW CU-CE12GKE**

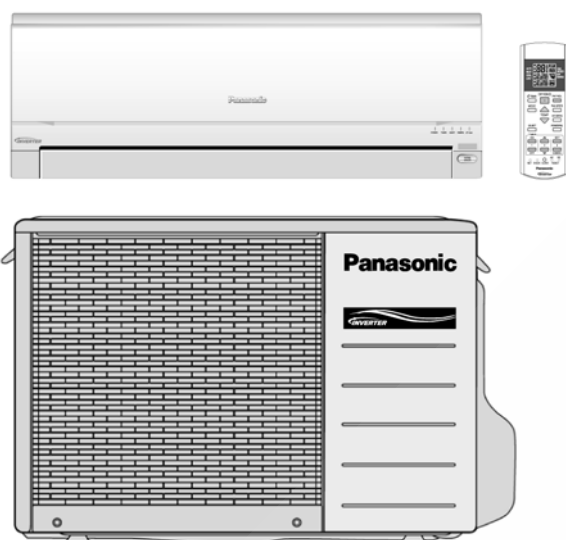

Please file and use this manual together with the service manual for Model No. CS-E9GKEW-5 / CU-E9GKE-5, CS-E12GKEW-5 / CU-E12GKE-5, Order No. MAC0612063C2.

### ⚠ WARNING

This service information is designed for experienced repair technicians only and is not designed for use by the general public. It does not contain warnings or cautions to advise non-technical individuals of potential dangers in attempting to service a product. Products powered by electricity should be serviced or repaired only by experienced professional technicians. Any attempt to service or repair the product or products dealt with in this service information by anyone else could result in serious injury or death.

### ⚠ PRECAUTION OF LOW TEMPERATURE

In order to avoid frostbite, be assured of no refrigerant leakage during the installation or repairing of refrigeration circuit.

## TABLE OF CONTENTS

	PAGE		PAGE
<b>1 Specifications</b> .....	<b>2</b>	2.1. Operation Characteristics .....	8
1.1. CS-CE7GKEW CU-CE7GKE .....	2	2.2. Sensible Capacity Chart .....	20
1.2. CS-CE9GKEW CU-CE9GKE .....	4	<b>3 Exploded View and Replacement Parts List</b> .....	<b>21</b>
1.3. CS-CE12GKEW CU-CE12GKE .....	6	3.1. Indoor Unit .....	21
<b>2 Technical Data</b> .....	<b>8</b>	3.2. Outdoor Unit .....	23

# Panasonic®

© 2007 Panasonic HA Air-Conditioning (M) Sdn. Bhd. (11969-T). All rights reserved. Unauthorized copying and distribution is a violation of law.

# 1 Specifications

## 1.1. CS-CE7GKEW CU-CE7GKE

ITEM		UNIT	INDOOR UNIT	OUTDOOR UNIT
Performance Test Condition		EUROVENT		
C O O L I N G	Capacity	kW	2.05 (0.70 ~ 2.40)	
		kCal/h	1760 (600 ~ 2060)	
	EER	W/W	4.27 (4.12 ~ 4.07)	
		kCal/hW	3.67 (3.53 ~ 3.49)	
	Noise Level	dB (A)	High 37, Low 24, Q-Lo 21	High 45
Power level dB		High 48, Low 35, Q-Lo 32	58	
H E A T I N G	Capacity	kW	2.80 (0.70 ~ 4.00)	
		kCal/h	2410 (600 ~ 3440)	
	COP	W/W	4.31 (4.38 ~ 3.92)	
		kCal/hW	3.71 (3.75 ~ 3.37)	
	Noise Level	dB (A)	High 38, Low 25, Q-Lo 22	High 46
Power level dB		High 49, Low 36, Q-Lo 33	59	
Moisture Removal		l/h	1.3	
		pt/h	2.7	
Air Volume	Q-Lo	m <sup>3</sup> /min (ft <sup>3</sup> /min)	Cooling; 4.6 (160) Heating; 5.1 (180)	—
	Lo	m <sup>3</sup> /min (ft <sup>3</sup> /min)	Cooling; 6.3 (220) Heating; 6.5 (230)	—
	Me	m <sup>3</sup> /min (ft <sup>3</sup> /min)	Cooling; 7.2 (250) Heating; 7.7 (270)	—
	Hi	m <sup>3</sup> /min (ft <sup>3</sup> /min)	Cooling; 9.8 (350) Heating; 10.3 (360)	Cooling; 28.8 (1020)
	SHi	m <sup>3</sup> /min (ft <sup>3</sup> /min)	Cooling; 10.1 (360) Heating; 10.7 (380)	—
Refrigeration Control Device			—	Check Valve & Capillary Tube
Refrigeration Oil		cm <sup>3</sup>	—	RB68A or Freol Alpha68M (320)
Refrigerant (R410A)		g (oz)	—	790 (27.9)
Dimension	Height	mm (inch)	280 (11-1/32)	540 (21-1/4)
	Width	mm (inch)	799 (31-15/32)	780 (30-23/32)
	Depth	mm (inch)	183 (7-7/32)	289 (11-3/8)
Net Weight		kg (lbs)	9 (20)	33 (73)
Pipe Diameter	Gas	mm (inch)	9.52 (3/8)	
	Liquid	mm (inch)	6.35 (1/4)	
Standard Length		m (ft)	7.5 (24.6)	
Pipe Length Range		m (ft)	3 (9.8) ~ 15 (49.2)	
Height Difference		m (ft)	15 (49.2)	
Additional Gas Amount		g/m (oz/ft)	20 (0.2)	
Refrigeration Charge Less		m (ft)	7.5 (24.6)	
Drain Hose	Inner Diameter	mm	16	—
	Length	mm	650	—
Compressor	Type		—	Hermetic Motor
	Motor Type		—	Brushless (6-pole)
	Rated Output	W	—	650

ITEM		UNIT	INDOOR UNIT	OUTDOOR UNIT	
Fan	Type		Cross-Flow Fan	Propeller Fan	
	Material		ASG20K1	PP	
	Motor Type		Transistor (8-pole)	Induction (6-pole)	
	Input Power	W	—	62	
	Output Power	W	30	25	
	Fan Speed	Q-Lo (Cool/Heat)	rpm	740 / 790	—
		Lo (Cool/Heat)	rpm	790 / 840	—
		Me (Cool/Heat)	rpm	1010 / 1070	—
Hi (Cool/Heat)		rpm	1230 / 1300	750 / -	
SHi (Cool/Heat)		rpm	1270 / 1340	—	
Heat Exchanger	Fin Material		Aluminium (Pre Coat)	Aluminium	
	Fin Type		Slit Fin	Corrugated Fin	
	Row x Stage x FPI		2 x 15 x 19	2 x 24 x 17	
	Size (W x H x L)	mm	610 x 315 x 25.4	36.4 x 504 x 713 684	
Air Filter	Material		Polypropelene	—	
	Type		One-Touch	—	

1. Cooling capacities are based on indoor temperature of 27°C D.B. (80.6°F D.B.), 19.0°C W.B. (66.2°F W.B.) and outdoor air temperature of 35°C D.B. (95°F D.B.), 24°C W.B. (75.2°F W.B.)
2. Heating capacities are based on indoor temperature of 20°C D.B. (68°F D.B.) and outdoor air temperature of 7°C D.B. (44.6°F D.B.), 6°C W.B. (42.8°F W.B.)

Item		Unit	
Power Source (Phase, Voltage, Cycle)		∅	Single
		V	230
		Hz	50
Input Power		W	Cooling; 480 (170 ~ 590) Heating; 650 (160 ~ 1020)
Starting Current		A	3.1
Running Current		A	Cooling; 2.3 Heating; 3.1
Power Factor		%	Cooling; 91 Heating; 91
Power factor means total figure of compressor, indoor fan motor and outdoor fan motor.			
*Maximum over current protection		A	4.8
Power Cord	Number of core		—
	Length	m	—
Thermostat			Electronic Control
Protection Device			Electronic Control

**Note**

- Specifications are subject to change without notice for further improvement.

## 1.2. CS-CE9GKEW CU-CE9GKE

ITEM		UNIT	INDOOR UNIT	OUTDOOR UNIT
Performance Test Condition		EUROVENT		
C O L I N G	Capacity	kW	2.60 (0.80 ~ 3.00)	
		kCal/h	2240 (690 ~ 2580)	
	EER	W/W	4.41 (4.57 ~ 4.00)	
		kCal/hW	3.80 (3.94 ~ 3.44)	
	Noise Level	dB (A)	High 39, Low 25, Q-Lo 21	High 46
Power level dB		High 50, Low 36, Q-Lo 32	59	
H E A T I N G	Capacity	kW	3.60 (0.80 ~ 5.00)	
		kCal/h	3100 (690 ~ 4300)	
	COP	W/W	4.31 (4.85 ~ 3.73)	
		kCal/hW	3.71 (4.18 ~ 3.21)	
	Noise Level	dB (A)	High 40, Low 27, Q-Lo 24	High 47
Power level dB		High 51, Low 38, Q-Lo 35	60	
Moisture Removal		l/h	1.6	
		pt/h	3.4	
Air Volume	Q-Lo	m <sup>3</sup> /min (ft <sup>3</sup> /min)	Cooling; 4.9 (170) Heating; 6.1 (220)	—
	Lo	m <sup>3</sup> /min (ft <sup>3</sup> /min)	Cooling; 6.6 (230) Heating; 7.1 (250)	—
	Me	m <sup>3</sup> /min (ft <sup>3</sup> /min)	Cooling; 7.8 (280) Heating; 8.6 (300)	—
	Hi	m <sup>3</sup> /min (ft <sup>3</sup> /min)	Cooling; 10.4 (370) Heating; 11.0 (390)	Cooling; 29.8 (1050)
	SHi	m <sup>3</sup> /min (ft <sup>3</sup> /min)	Cooling; 10.7 (380) Heating; 11.4 (400)	—
Refrigeration Control Device			—	Check Valve & Capillary Tube
Refrigeration Oil		cm <sup>3</sup>	—	RB68A or Freol Alpha68M (320)
Refrigerant (R410A)		g (oz)	—	965 (34.1)
Dimension	Height	mm (inch)	280 (11-1/32)	540 (21-1/4)
	Width	mm (inch)	799 (31-15/32)	780 (30-23/32)
	Depth	mm (inch)	183 (7-7/32)	289 (11-3/8)
Net Weight		kg (lbs)	9 (20)	34 (75)
Pipe Diameter	Gas	mm (inch)	9.52 (3/8)	
	Liquid	mm (inch)	6.35 (1/4)	
Standard Length		m (ft)	7.5 (24.6)	
Pipe Length Range		m (ft)	3 (9.8) ~ 15 (49.2)	
Height Difference		m (ft)	15 (49.2)	
Additional Gas Amount		g/m (oz/ft)	20 (0.2)	
Refrigeration Charge Less		m (ft)	7.5 (24.6)	
Drain Hose	Inner Diameter	mm	16	—
	Length	mm	650	—
Compressor	Type		—	Hermetic Motor
	Motor Type		—	Brushless (6-pole)
	Rated Output	W	—	700

ITEM		UNIT	INDOOR UNIT	OUTDOOR UNIT	
Fan	Type		Cross-Flow Fan	Propeller Fan	
	Material		ASG20K1	PP	
	Motor Type		Transistor (8-pole)	Induction (6-pole)	
	Input Power	W	—	65	
	Output Power	W	30	25	
	Fan Speed	Q-Lo (Cool/Heat)	rpm	770 / 890	—
		Lo (Cool/Heat)	rpm	830 / 940	—
Me (Cool/Heat)		rpm	1070 / 1170	—	
Hi (Cool/Heat)		rpm	1310 / 1420	770 / —	
SHi (Cool/Heat)		rpm	1350 / 1460	—	
Heat Exchanger	Fin Material		Aluminium (Pre Coat)	Aluminium	
	Fin Type		Slit Fin	Corrugated Fin	
	Row x Stage x FPI		2 x 15 x 19	2 x 24 x 17	
	Size (W x H x L)	mm	610 x 315 x 25.4	36.4 x 504 x 713 684	
Air Filter	Material		Polypropelene	—	
	Type		One-Touch	—	

1. Cooling capacities are based on indoor temperature of 27°C D.B. (80.6°F D.B.), 19.0°C W.B. (66.2°F W.B.) and outdoor air temperature of 35°C D.B. (95°F D.B.), 24°C W.B. (75.2°F W.B.)
2. Heating capacities are based on indoor temperature of 20°C D.B. (68°F D.B.) and outdoor air temperature of 7°C D.B. (44.6°F D.B.), 6°C W.B. (42.8°F W.B.)

Item	Unit	
Power Source (Phase, Voltage, Cycle)	∅	Single
	V	230
	Hz	50
Input Power	W	Cooling; 590 (175 ~ 750) Heating; 835 (165 ~ 1340)
Starting Current	A	3.9
Running Current	A	Cooling; 2.8 Heating; 3.9
Power Factor	%	Cooling; 92 Heating; 93
Power factor means total figure of compressor, indoor fan motor and outdoor fan motor.		
*Maximum over current protection	A	5.9
Power Cord	Number of core	—
	Length	m
Thermostat		Electronic Control
Protection Device		Electronic Control

Note

- Specifications are subject to change without notice for further improvement.

### 1.3. CS-CE12GKEW CU-CE12GKE

ITEM		UNIT	INDOOR UNIT	OUTDOOR UNIT
Performance Test Condition		EUROVENT		
C O L I N G	Capacity	kW	3.50 (0.80 ~ 4.00)	
		kCal/h	3010 (690 ~ 3440)	
	EER	W/W	3.83 (4.32 ~ 3.39)	
		kCal/hW	3.29 (3.73 ~ 2.92)	
	Noise Level	dB (A)	High 42, Low 28, Q-Lo 21	High 48
Power level dB		High 53, Low 39, Q-Lo 32	61	
H E A T I N G	Capacity	kW	4.80 (0.80 ~ 6.50)	
		kCal/h	4130 (690 ~ 5590)	
	COP	W/W	3.81 (4.57 ~ 3.44)	
		kCal/hW	3.28 (3.94 ~ 2.96)	
	Noise Level	dB (A)	High 42, Low 33, Q-Lo 30	High 50
Power level dB		High 53, Low 44, Q-Lo 41	63	
Moisture Removal		l/h	2.0	
		pt/h	4.2	
Air Volume	Q-Lo	m <sup>3</sup> /min (ft <sup>3</sup> /min)	Cooling; 5.0 (180) Heating; 8.0 (280)	—
	Lo	m <sup>3</sup> /min (ft <sup>3</sup> /min)	Cooling; 7.0 (250) Heating; 8.5 (300)	—
	Me	m <sup>3</sup> /min (ft <sup>3</sup> /min)	Cooling; 8.7 (310) Heating; 9.9 (350)	—
	Hi	m <sup>3</sup> /min (ft <sup>3</sup> /min)	Cooling; 11.2 (400) Heating; 11.7 (410)	Cooling; 31.0 (1090)
	SHi	m <sup>3</sup> /min (ft <sup>3</sup> /min)	Cooling; 11.5 (410) Heating; 12.1 (430)	—
Refrigeration Control Device			—	Check Valve & Capillary Tube
Refrigeration Oil		cm <sup>3</sup>	—	RB68A or Freol Alpha68M (320)
Refrigerant (R410A)		g (oz)	—	980 (34.6)
Dimension	Height	mm (inch)	280 (11-1/32)	540 (21-1/4)
	Width	mm (inch)	799 (31-15/32)	780 (30-23/32)
	Depth	mm (inch)	183 (7-7/32)	289 (11-3/8)
Net Weight		kg (lbs)	9 (20)	35 (77)
Pipe Diameter	Gas	mm (inch)	12.7 (1/2)	
	Liquid	mm (inch)	6.35 (1/4)	
Standard Length		m (ft)	7.5 (24.6)	
Pipe Length Range		m (ft)	3 (9.8) ~ 15 (49.2)	
Height Difference		m (ft)	15 (49.2)	
Additional Gas Amount		g/m (oz/ft)	20 (0.2)	
Refrigeration Charge Less		m (ft)	7.5 (24.6)	
Drain Hose	Inner Diameter	mm	16	—
	Length	mm	650	—
Compressor	Type		—	Hermetic Motor
	Motor Type		—	Brushless (6-pole)
	Rated Output	W	—	700

ITEM		UNIT	INDOOR UNIT	OUTDOOR UNIT	
Fan	Type		Cross-Flow Fan	Propeller Fan	
	Material		ASG20K1	PP	
	Motor Type		Transistor (8-pole)	Induction (6-pole)	
	Input Power	W	—	70	
	Output Power	W	30	30	
	Fan Speed	Q-Lo (Cool/Heat)	rpm	780 / 1090	—
		Lo (Cool/Heat)	rpm	920 / 1150	—
Me (Cool/Heat)		rpm	1175 / 1325	—	
Hi (Cool/Heat)		rpm	1430 / 1500	830 / —	
SHi (Cool/Heat)		rpm	1470 / 1540	—	
Heat Exchanger	Fin Material		Aluminium (Pre Coat)	Aluminium	
	Fin Type		Slit Fin	Corrugated Fin	
	Row x Stage x FPI		2 x 15 x 21	2 x 24 x 17	
	Size (W x H x L)	mm	610 x 315 x 25.4	36.4 x 504 x 713 684	
Air Filter	Material		Polypropelene	—	
	Type		One-Touch	—	

1. Cooling capacities are based on indoor temperature of 27°C D.B. (80.6°F D.B.), 19.0°C W.B. (66.2°F W.B.) and outdoor air temperature of 35°C D.B. (95°F D.B.), 24°C W.B. (75.2°F W.B.)
2. Heating capacities are based on indoor temperature of 20°C D.B. (68°F D.B.) and outdoor air temperature of 7°C D.B. (44.6°F D.B.), 6°C W.B. (42.8°F W.B.)

Item	Unit	
Power Source (Phase, Voltage, Cycle)	ø	Single
	V	230
	Hz	50
Input Power	W	Cooling; 915 (185 ~ 1180) Heating; 1260 (175 ~ 1890)
Starting Current	A	5.8
Running Current	A	Cooling; 4.2 Heating; 5.8
Power Factor	%	Cooling; 95 Heating; 95
Power factor means total figure of compressor, indoor fan motor and outdoor fan motor.		
*Maximum over current protection	A	8.7
Power Cord	Number of core	—
	Length	m
Thermostat		Electronic Control
Protection Device		Electronic Control

Note

- Specifications are subject to change without notice for further improvement.

## 2 Technical Data

### 2.1. Operation Characteristics

#### 2.1.1. CS-CE7GKEW CU-CE7GKE

##### • Cooling Characteristic

[Condition] Room temperature: 27/19°C

Operation condition: High fan speed (Rated Frequency)

Piping length: 7.5 m

◇ 220V  
◆ 230V  
△ 240V

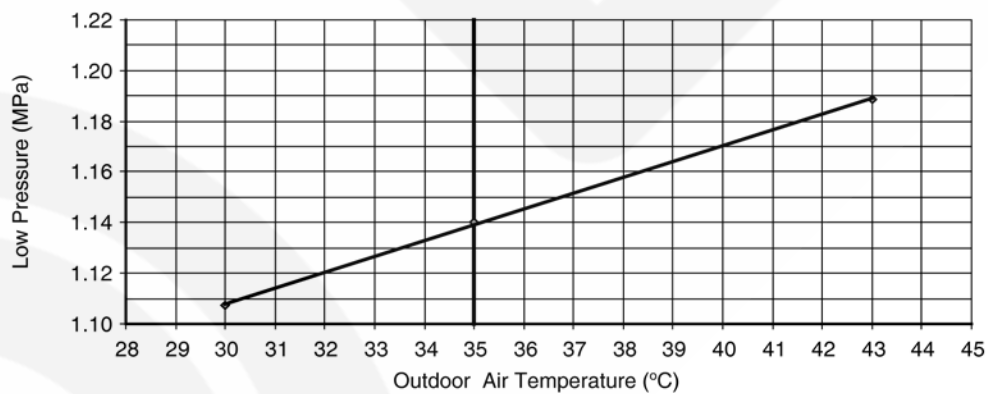
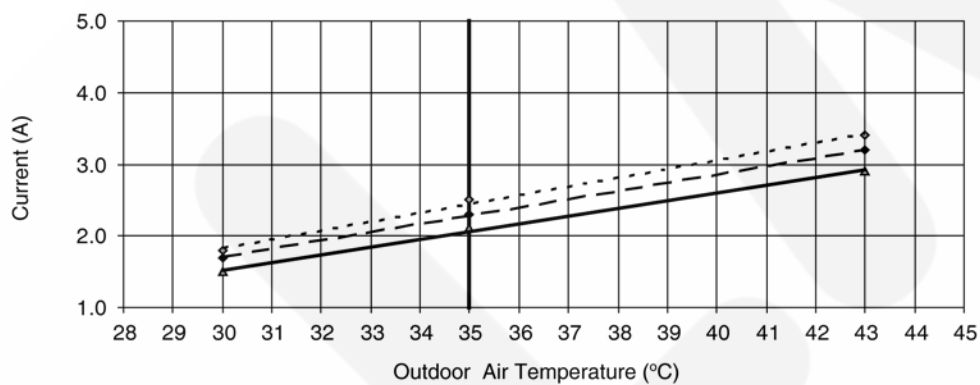
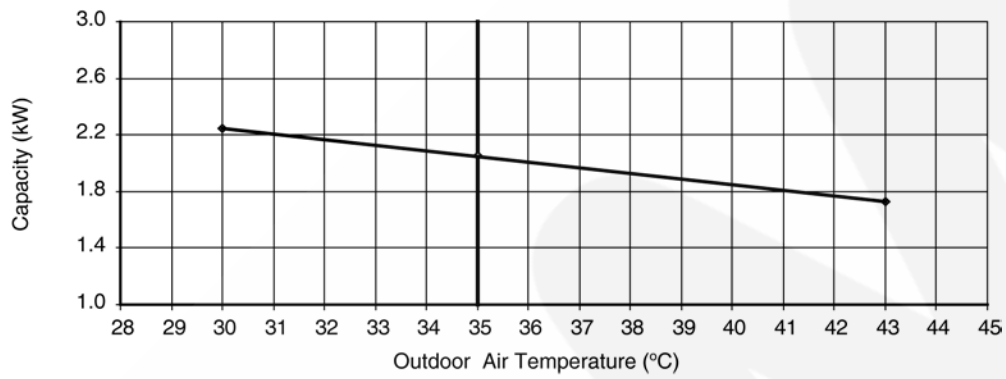
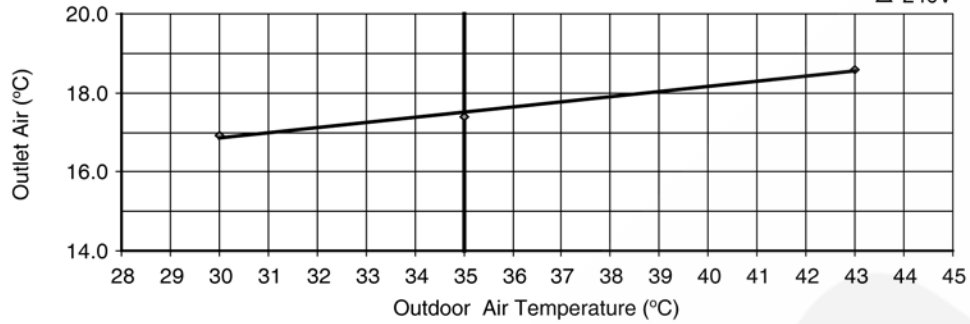



## • Piping Length Characteristic

[Condition] Room temperature: 27/19°C  
 Operation condition: High fan speed (Rated Frequency)  
 Outdoor temperature: 35/24°C

▲ 220V  
 ◆ 230V  
 ■ 240V

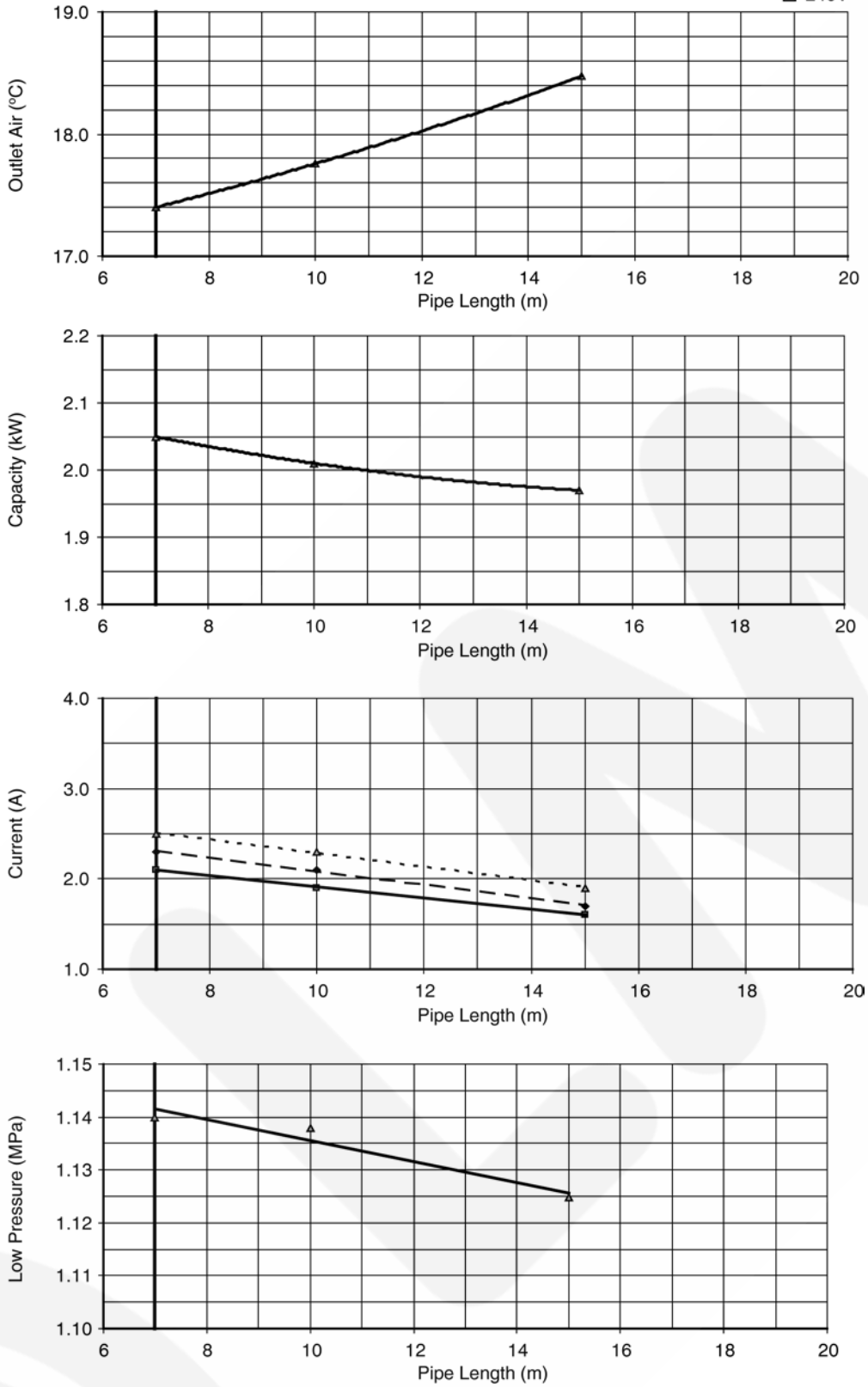

## • Heating Characteristic

[Condition] Room temperature: 20/-°C

Operation condition: High fan speed (Rated Frequency)

Piping length: 7.5 m

▲ 220V  
◆ 230V  
■ 240V

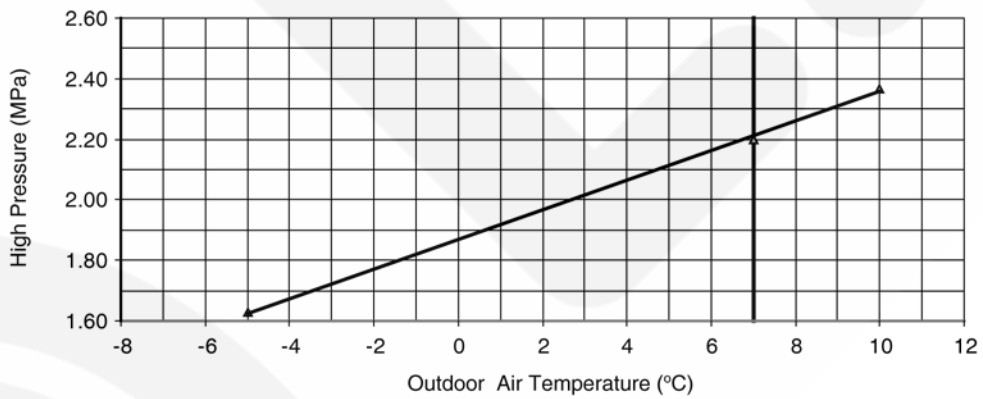
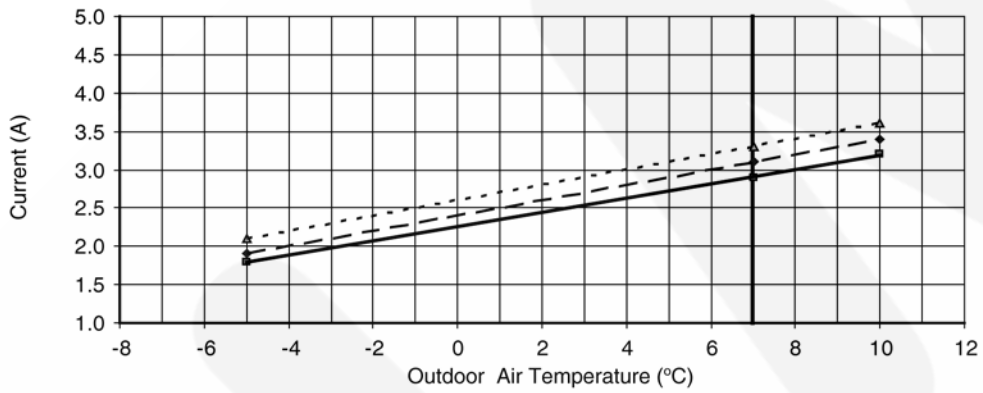
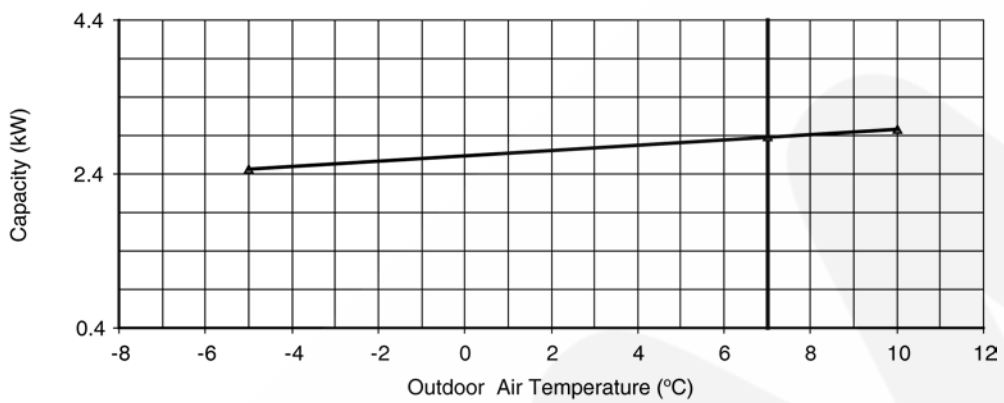
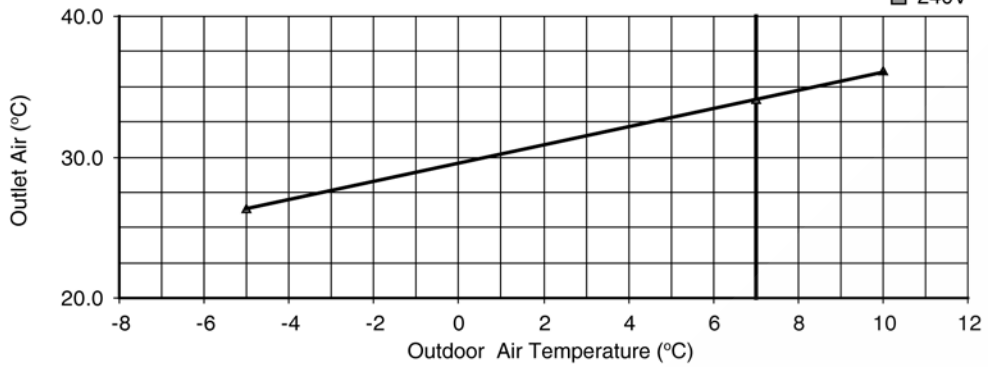

# • Piping Length Characteristic

[Condition] Room temperature: 20/-°C  
 Operation condition: High fan speed (Rated Frequency)  
 Outdoor temperature: 35/24°C

▲ 220V  
 ◆ 230V  
 ■ 240V

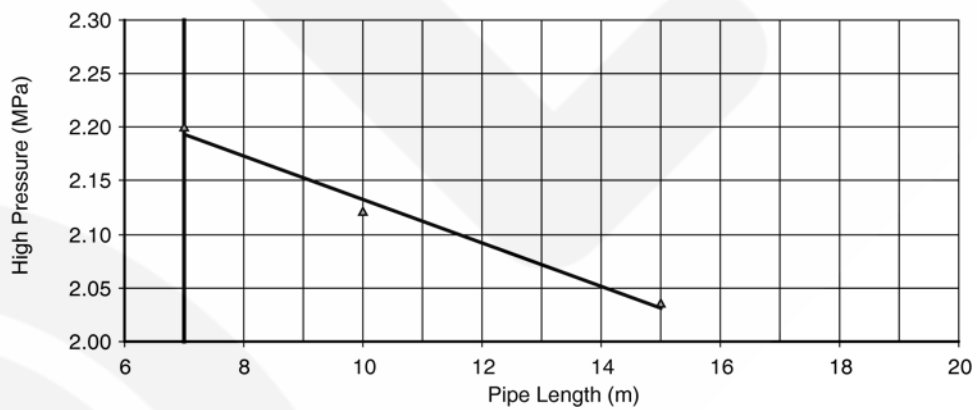
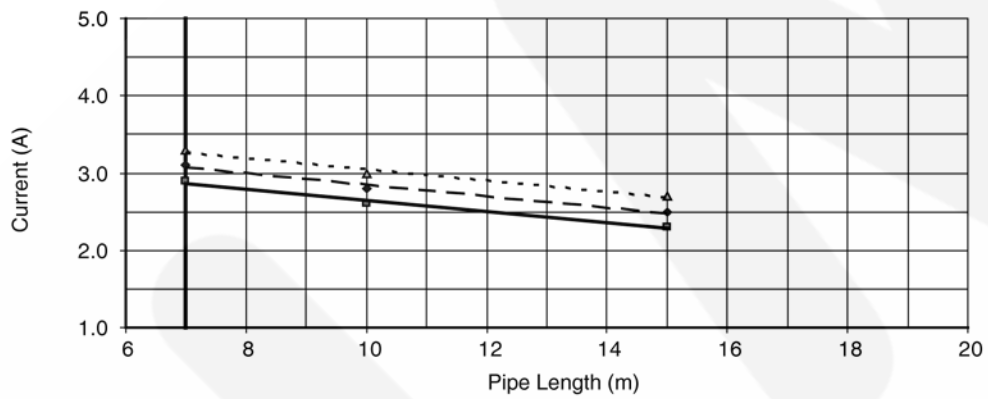
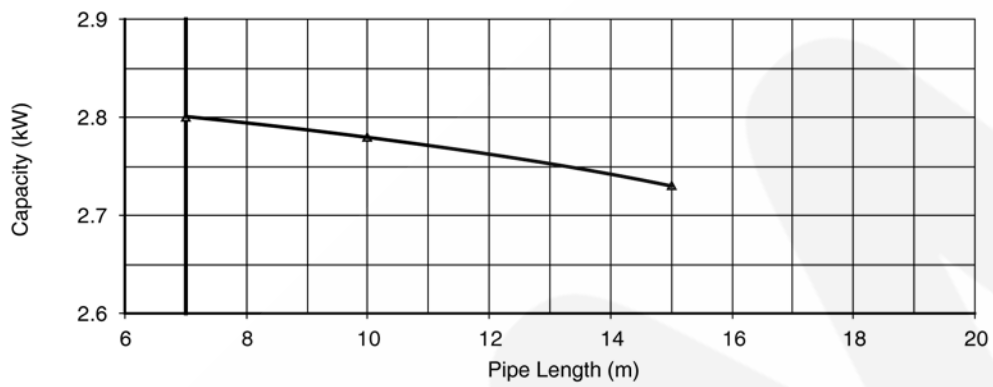
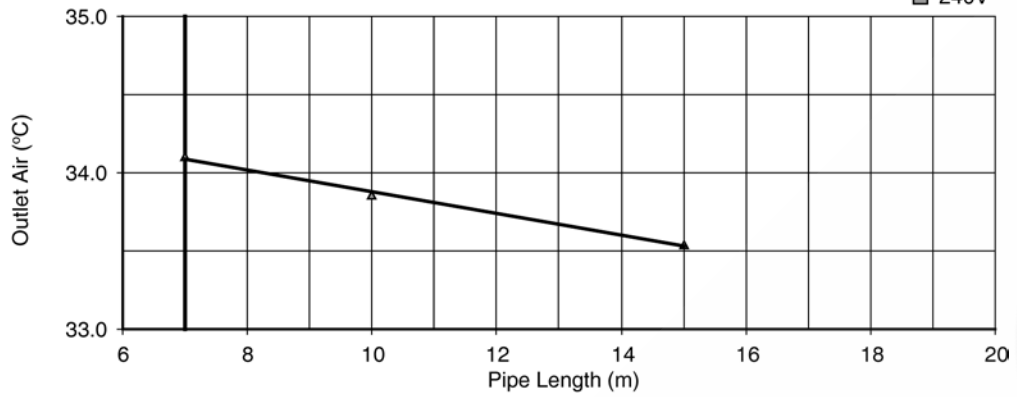

## 2.1.2. CS-CE9GKEW CU-CE9GKE

### • Cooling Characteristic

[Condition] Room temperature: 27/19°C

Operation condition: High fan speed (Rated Frequency)

Piping length: 7.5 m

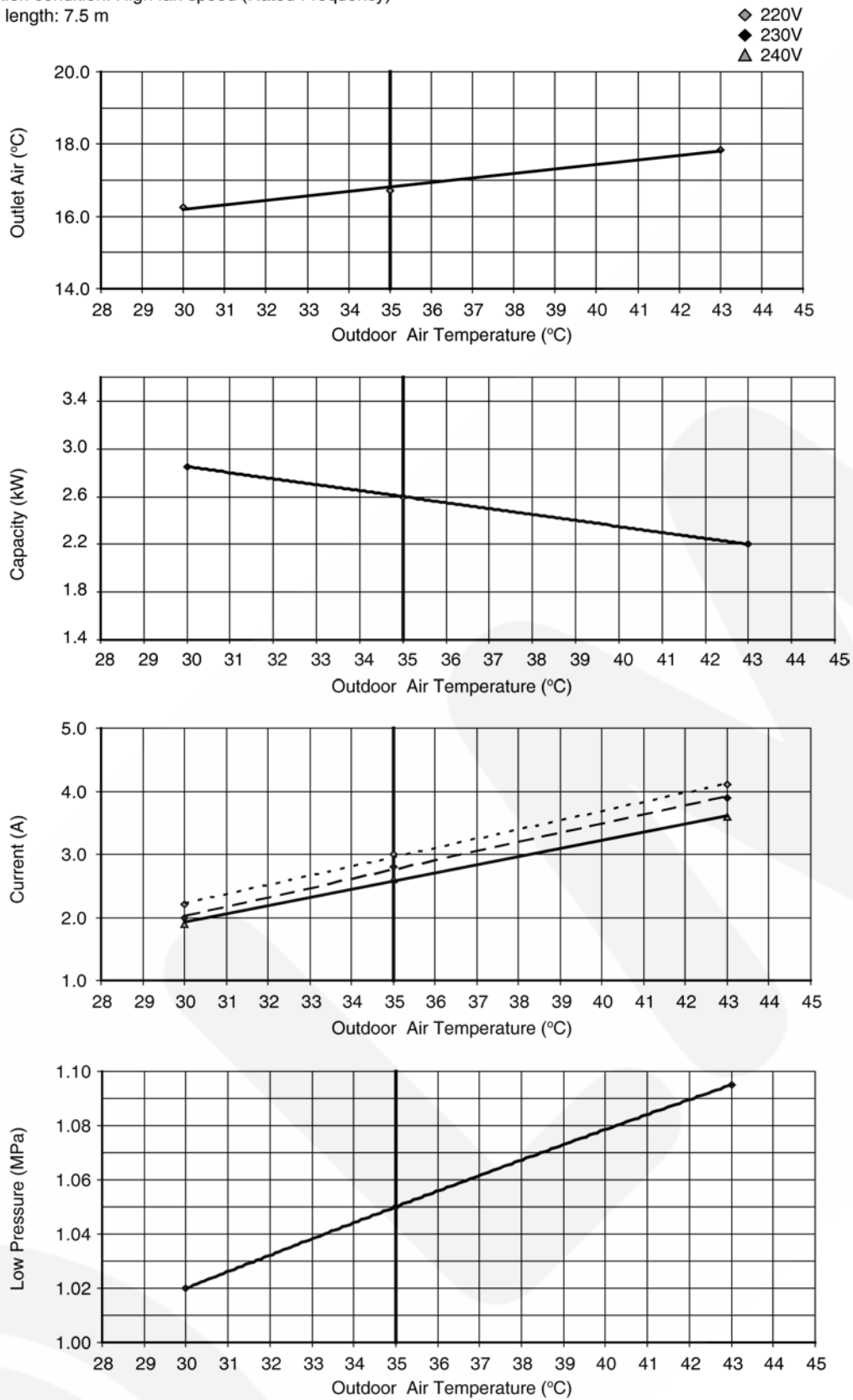

## • Piping Length Characteristic

[Condition] Room temperature: 27/19°C  
 Operation condition: High fan speed (Rated Frequency)  
 Outdoor temperature: 35/24°C

▲ 220V  
 ◆ 230V  
 ■ 240V

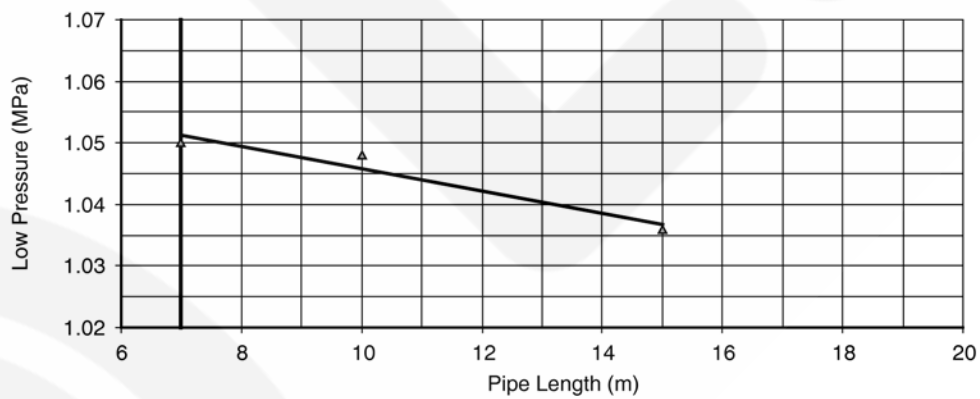
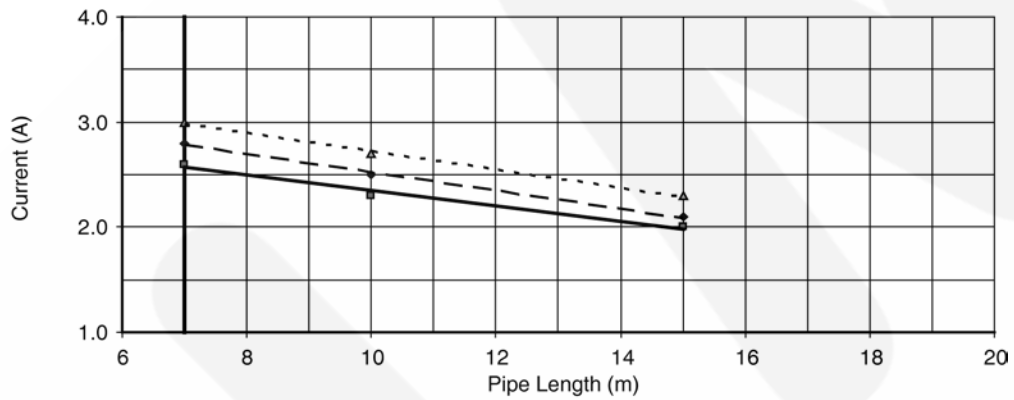
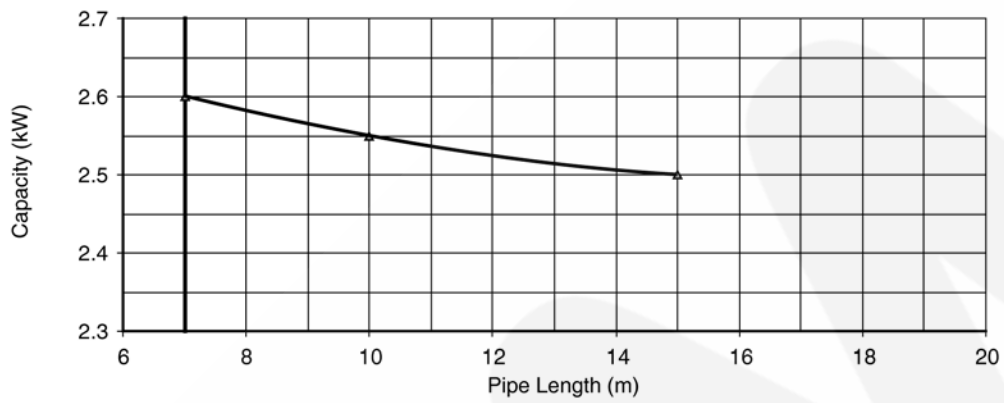
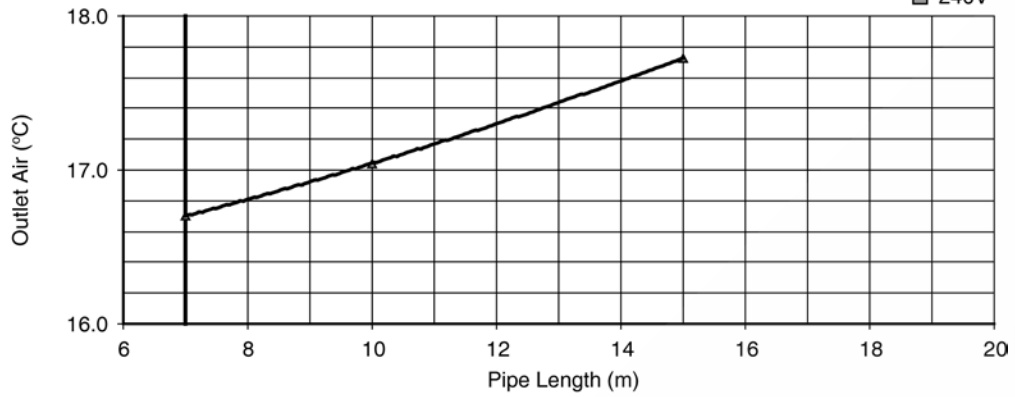

## • Heating Characteristic

[Condition] Room temperature: 20/-°C

Operation condition: High fan speed (Rated Frequency)

Piping length: 7.5 m

▲ 220V  
◆ 230V  
■ 240V

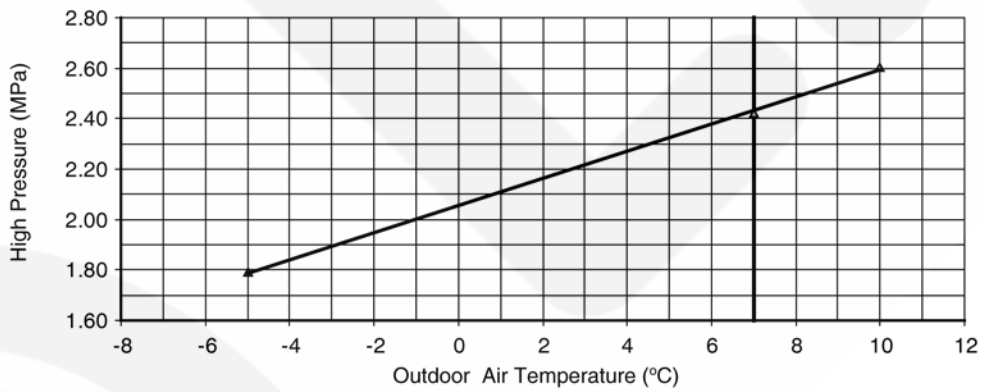
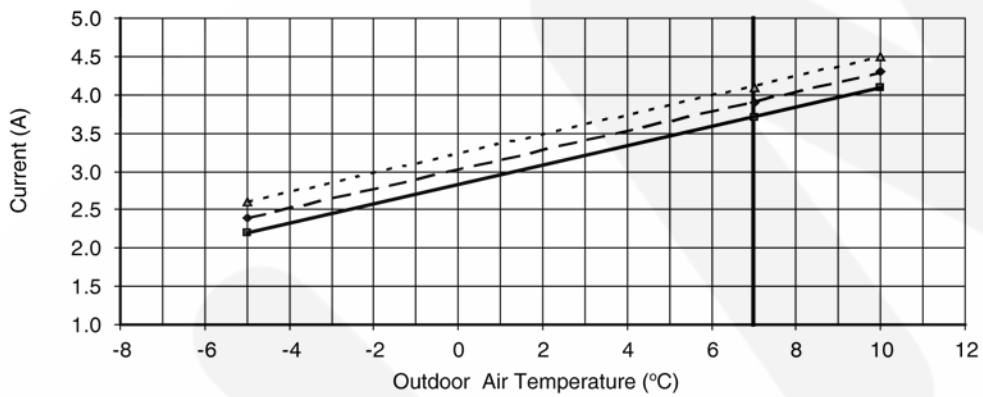
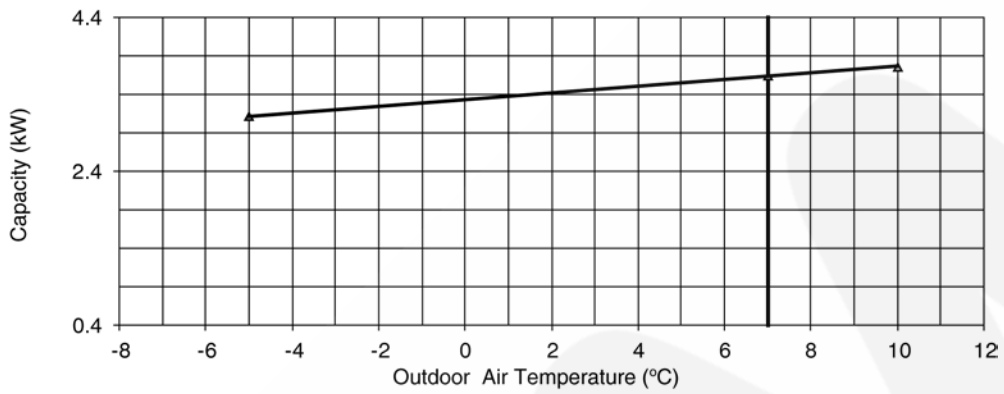
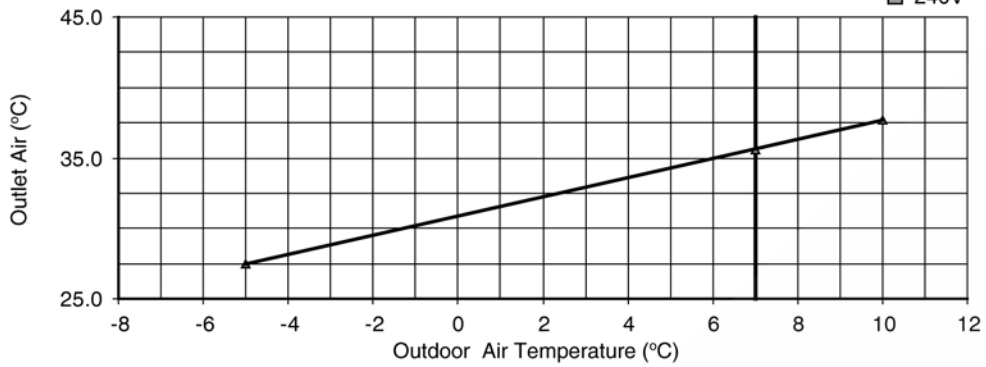

# • Piping Length Characteristic

[Condition] Room temperature: 20/-°C  
 Operation condition: High fan speed (Rated Frequency)  
 Outdoor temperature: 35/24°C

▲ 220V  
 ◆ 230V  
 ■ 240V

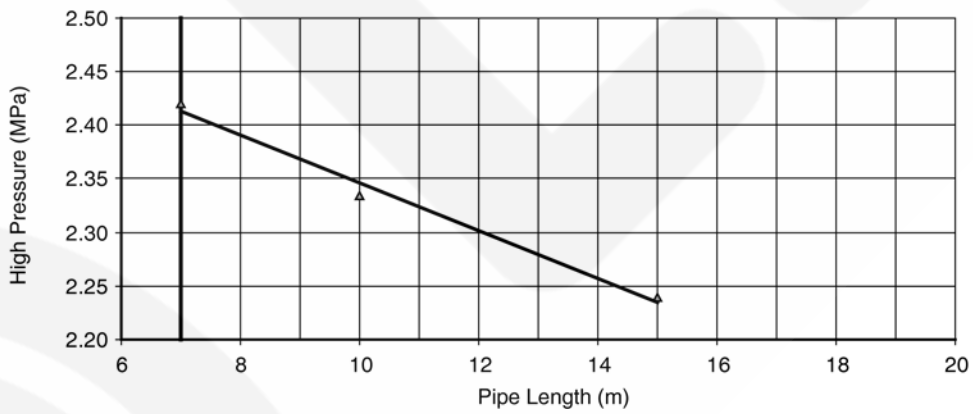
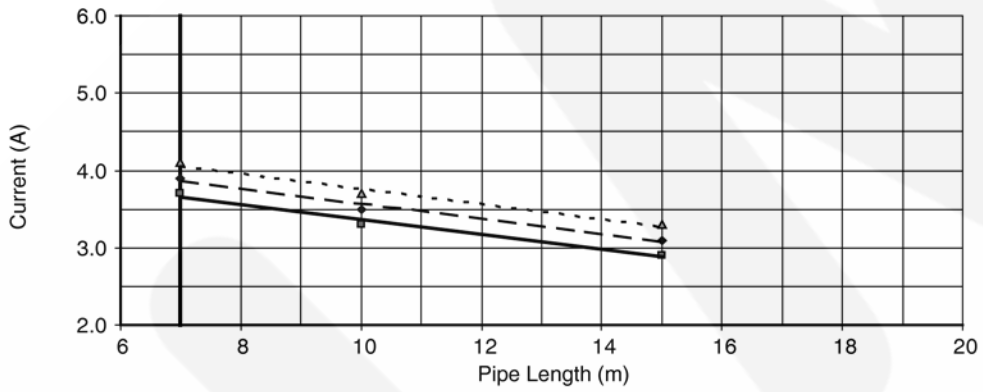
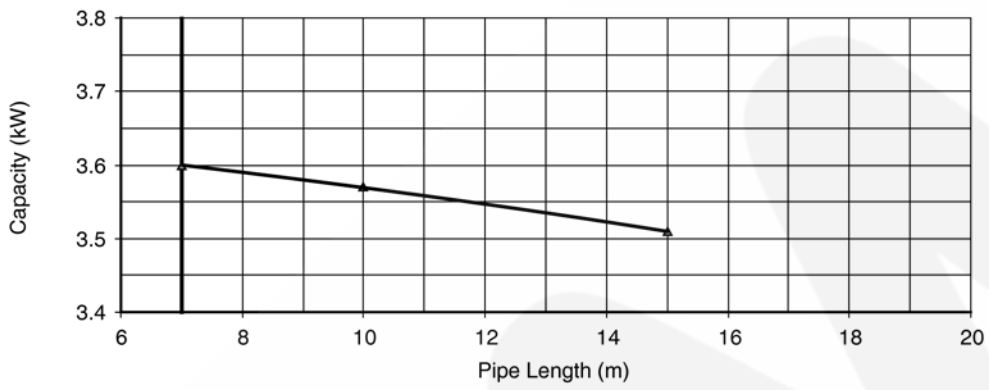
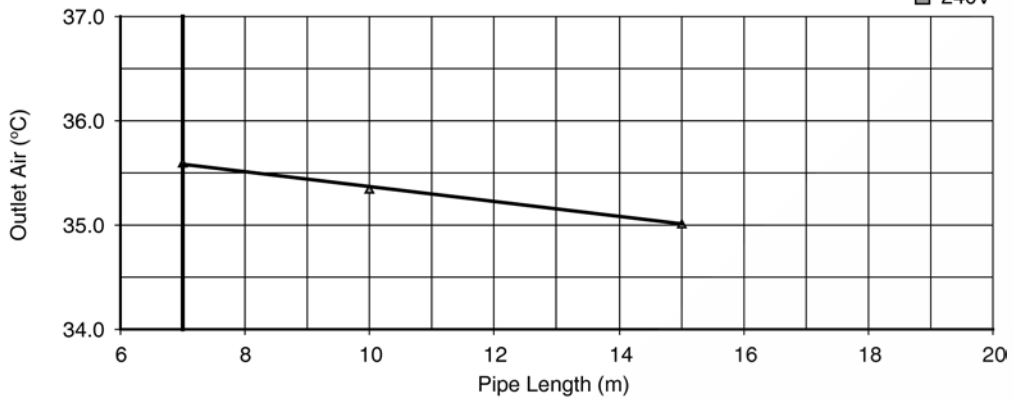

### 2.1.3. CS-CE12GKEW CU-CE12GKE

#### • Cooling Characteristic

[Condition] Room temperature: 27/19°C

Operation condition: High fan speed (Rated Frequency)

Piping length: 7.5 m

◇ 220V  
◆ 230V  
△ 240V

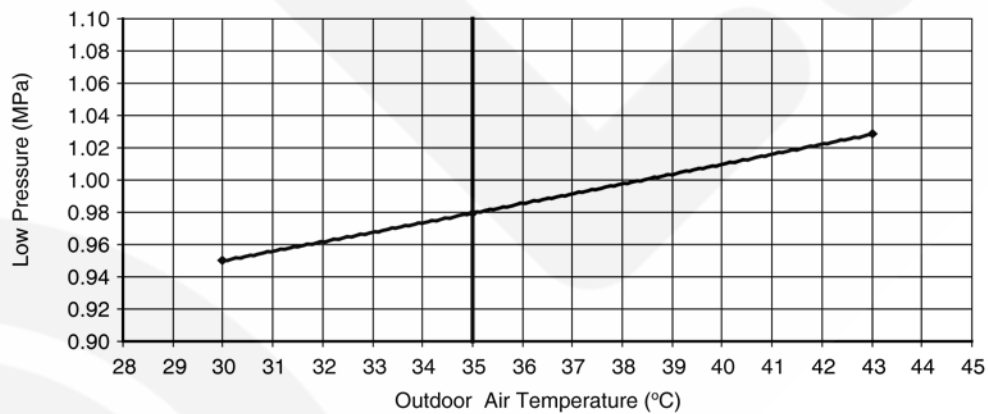
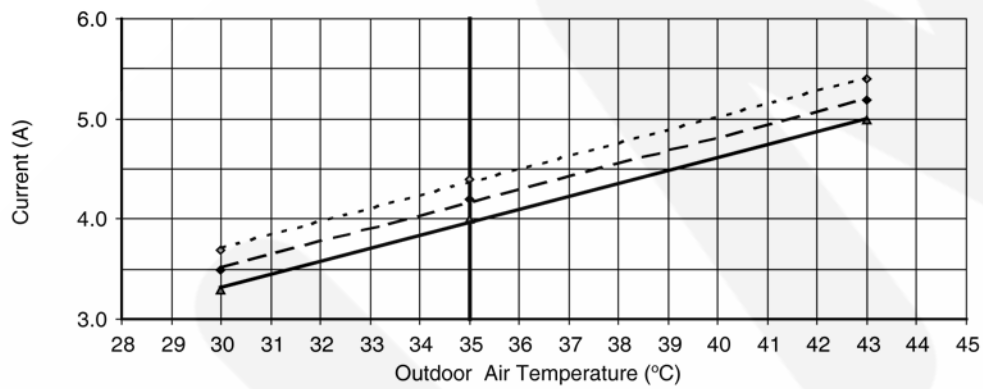
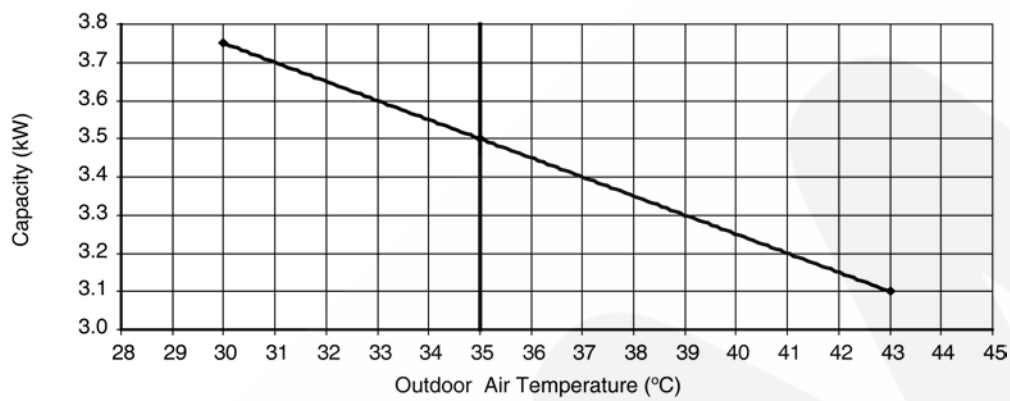
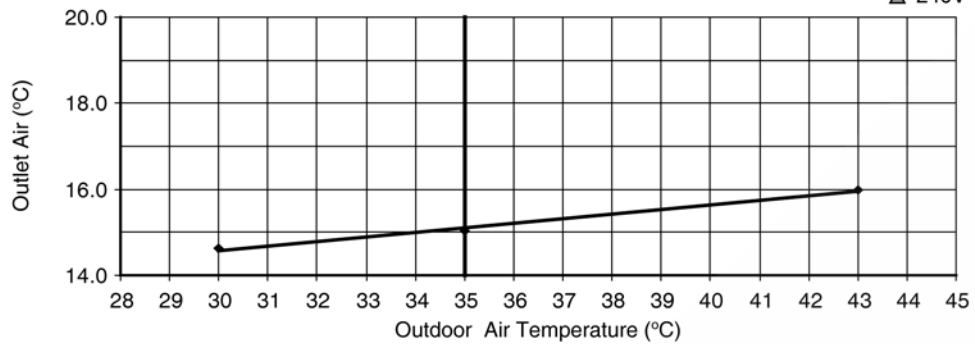



## • Piping Length Characteristic

[Condition] Room temperature: 27/19°C  
 Operation condition: High fan speed (Rated Frequency)  
 Outdoor temperature: 35/24°C

▲ 220V  
 ◆ 230V  
 ■ 240V

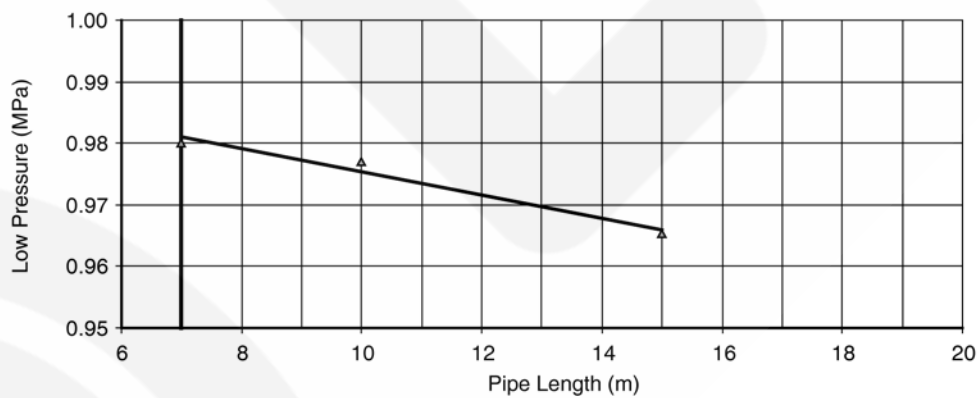
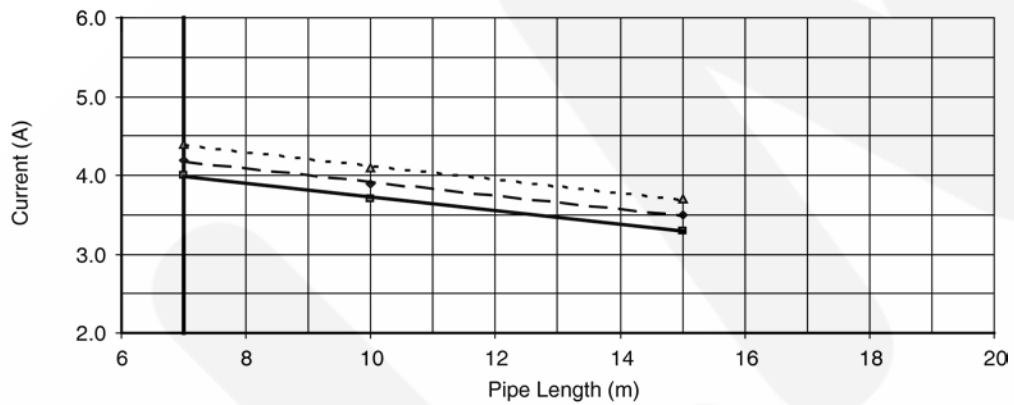
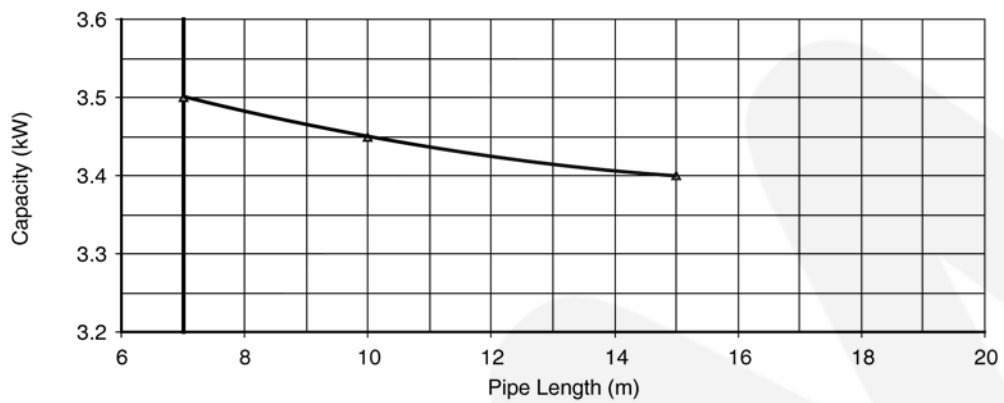
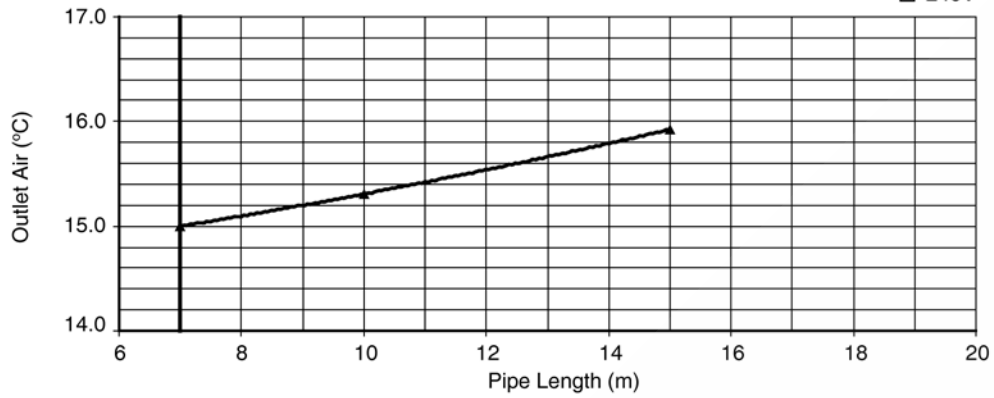

## • Heating Characteristic

[Condition] Room temperature: 20/-°C

Operation condition: High fan speed (Rated Frequency)

Piping length: 7.5 m

▲ 220V  
◆ 230V  
■ 240V

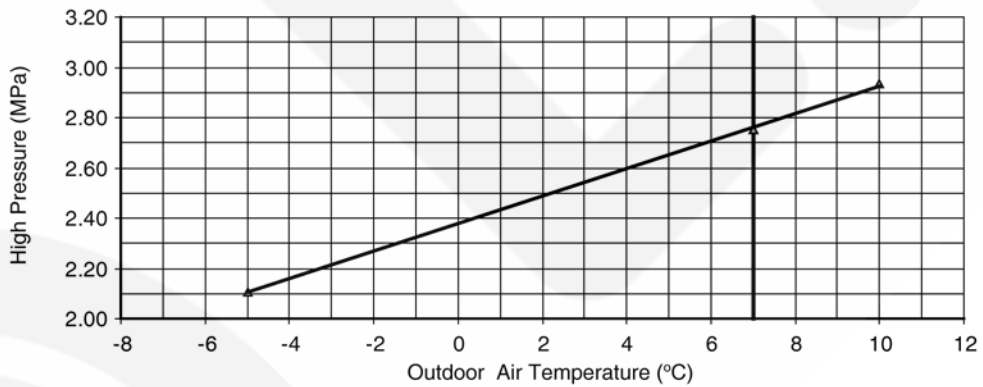
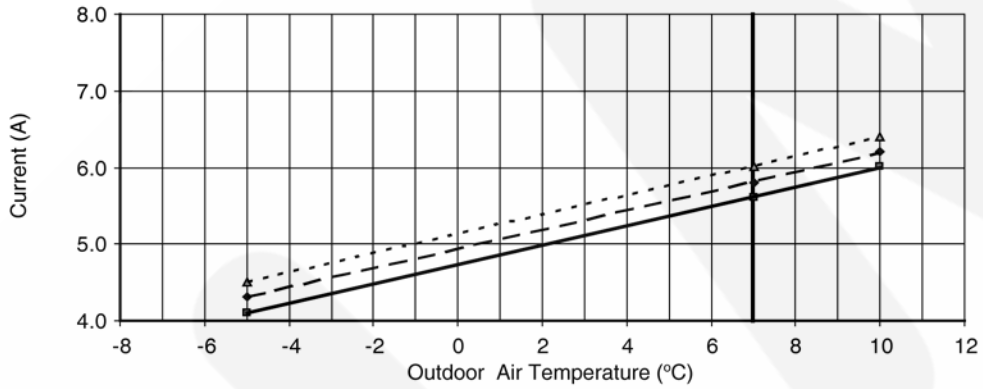
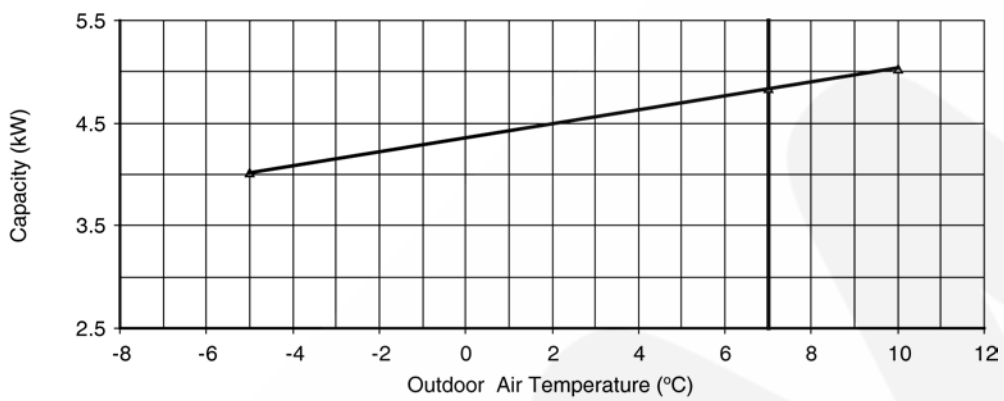
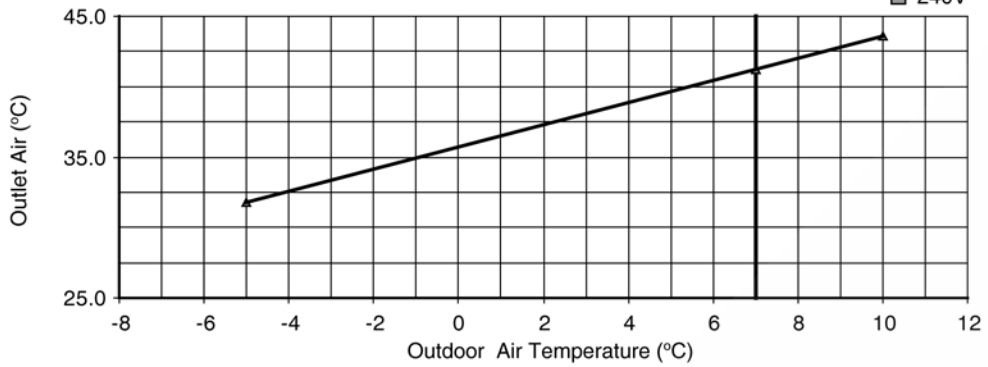

# • Piping Length Characteristic

[Condition] Room temperature: 20/-°C  
 Operation condition: High fan speed (Rated Frequency)  
 Outdoor temperature: 35/24°C

▲ 220V  
 ◆ 230V  
 ■ 240V

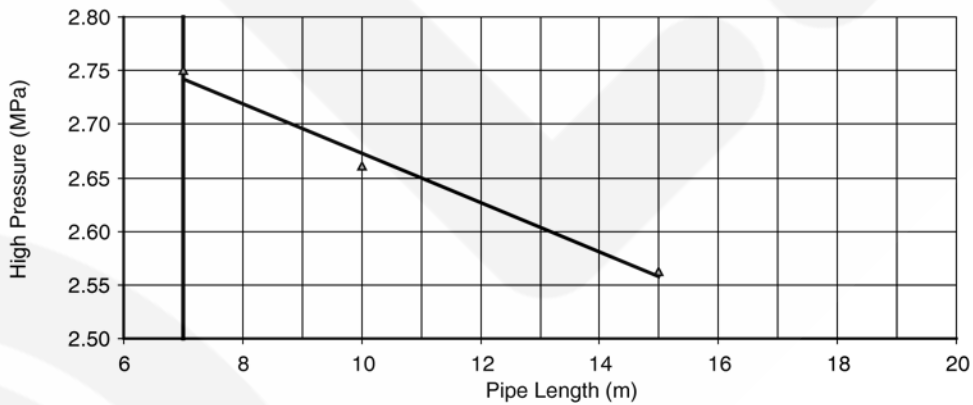
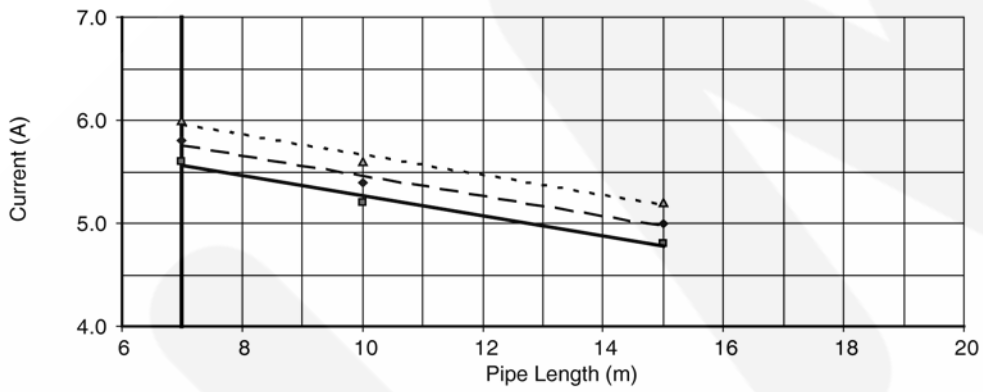
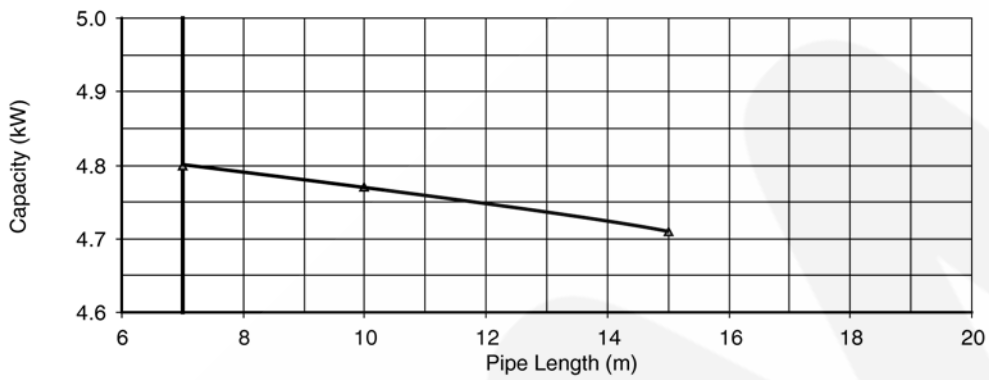
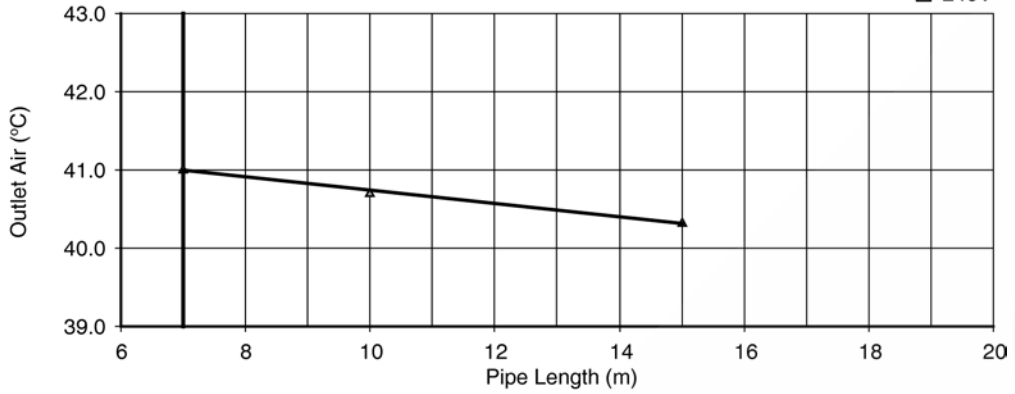

## 2.2. Sensible Capacity Chart

### ● CS-CE7GKEW CU-CE7GKE

230V Indoor wet bulb temp.	Outdoor Temp. (°C)											
	30			35			40			46		
	TC	SHC	IP	TC	SHC	IP	TC	SHC	IP	TC	SHC	IP
17.0°C	2.03	1.54	0.44	1.90	1.48	0.47	1.77	1.42	0.51	1.61	1.35	0.55
19.0°C				2.05		0.48						
19.5°C	2.23	1.61	0.45	2.09	1.55	0.48	1.94	1.49	0.52	1.77	1.42	0.56
22.0°C	2.43	1.67	0.46	2.27	1.61	0.49	2.12	1.55	0.52	1.92	1.48	0.57

### ● CS-CE9GKEW CU-CE9GKE

230V Indoor wet bulb temp.	Outdoor Temp. (°C)											
	30			35			40			46		
	TC	SHC	IP	TC	SHC	IP	TC	SHC	IP	TC	SHC	IP
17.0°C	2.58	1.96	0.54	2.41	1.88	0.58	2.24	1.80	0.62	2.04	1.71	0.67
19.0°C				2.60		0.59						
19.5°C	2.83	2.05	0.55	2.65	1.97	0.59	2.46	1.89	0.63	2.24	1.80	0.68
22.0°C	3.09	2.12	0.56	2.88	2.04	0.60	2.68	1.97	0.64	2.44	1.88	0.70

### ● CS-CE12GKEW CU-CE12GKE

230V Indoor wet bulb temp.	Outdoor Temp. (°C)											
	30			35			40			46		
	TC	SHC	IP	TC	SHC	IP	TC	SHC	IP	TC	SHC	IP
17.0°C	3.47	2.63	0.84	3.24	2.52	0.91	3.02	2.43	0.97	2.74	2.30	1.05
19.0°C				3.50		0.92						
19.5°C	3.81	2.76	0.86	3.56	2.65	0.92	3.31	2.55	0.99	3.01	2.43	1.07
22.0°C	4.15	2.86	0.87	3.88	2.75	0.94	3.61	2.65	1.01	3.28	2.53	1.08

TC - Total Cooling Capacity (kW)  
 SHC - Sensible Heat Capacity (kW)  
 IP - Input Power (kW)

Indoor 27°C/19°C  
 Outdoor 35°C/24°C

# 3 Exploded View and Replacement Parts List

## 3.1. Indoor Unit

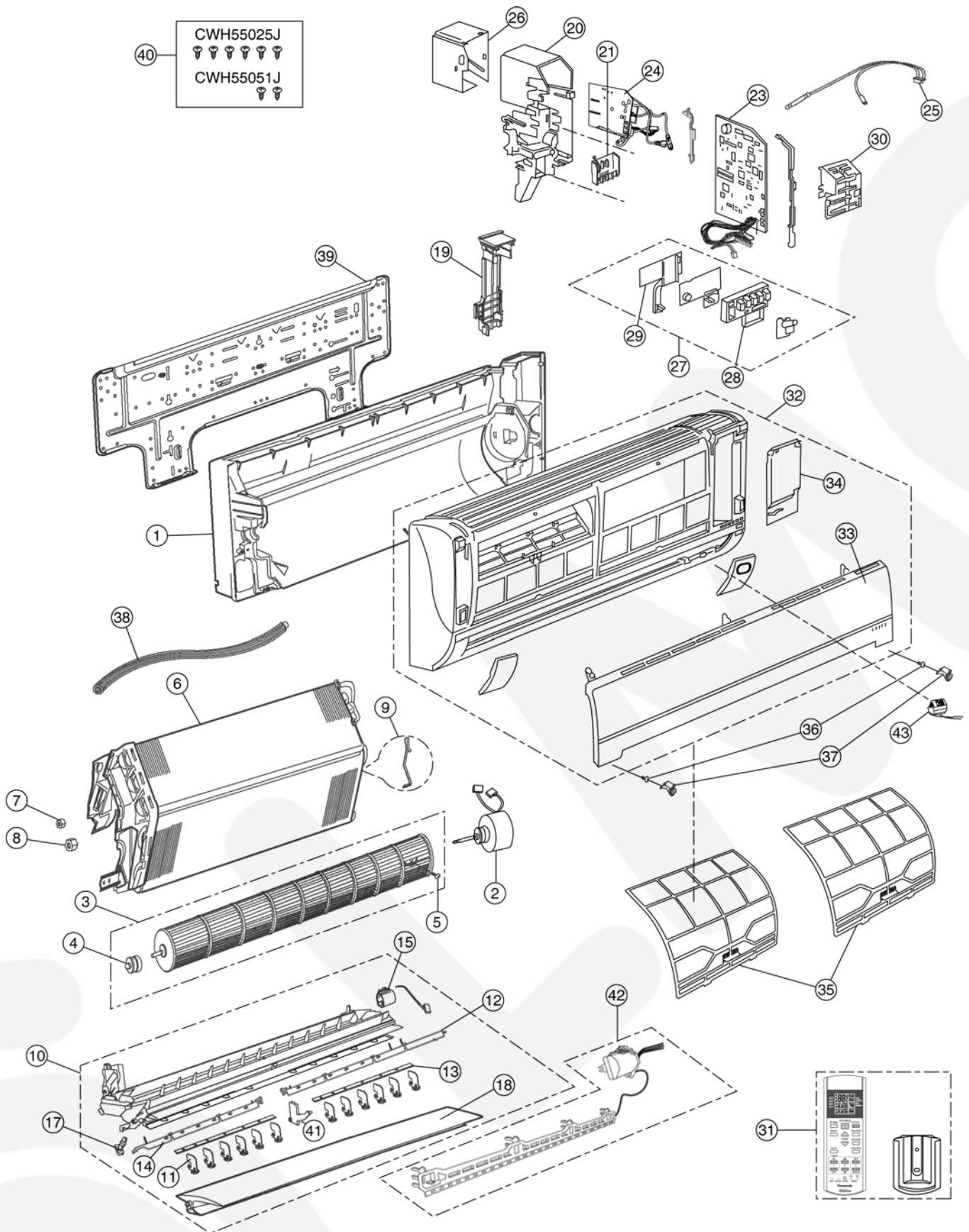

**Note**  
 The above exploded view is for the purpose of parts disassembly and replacement.  
 The non-numbered parts are not kept as standard service parts.

REF. NO.	PART NAME & DESCRIPTION	QTY.	CS-CE7GKEW	CS-CE9GKEW	CS-CE12GKEW	REMARKS
1	CHASSY COMPLETE	1	CWD50C1513	←	←	
2	FAN MOTOR	1	ARW61F8P30AC	←	←	O
3	CROSS FLOW FAN COMPLETE	1	CWH02C1045	←	←	
4	BEARING ASSY	1	CWH64K007	←	←	
5	SCREW - CROSS FLOW FAN	1	CWH551146	←	←	
6	EVAPORATOR	1	CWB30C2099	←	CWB30C2115	
7	FLARE NUT (1/4")	1	CWT251030	←	←	
8	FLARE NUT (3/8") (1/2")	1	CWT251031	←	CWT251032	
9	CLIP FOR SENSOR	1	CWH32143	←	←	
10	DISCHARGE GRILLE COMPLETE	1	CWE20C2621	←	←	
11	VERTICAL VANE	12	CWE241157	←	←	
12	CONNECTING BAR	1	CWE261092	←	←	
13	CONNECTING BAR	2	CWE261071	←	←	
14	CONNECTING BAR	1	CWE261091	←	←	
15	AIR SWING MOTOR	1	CWA981091	←	←	O
17	CAP - DRAIN TRAY	1	CWH521096	←	←	
18	HORIZONTAL VANE COMPLETE	1	CWE24C1176	←	←	
19	BACK COVER CHASSIS	1	CWD932454	←	←	
20	CONTROL BOARD CASING	1	CWH102321	←	←	
21	TERMINAL BOARD COMPLETE	1	CWA28C2305	←	←	O
23	ELECTRONIC CONTROLLER - MAIN	1	CWA73C2532	CWA73C2533	CWA73C2534	O
24	ELECTRONIC CONTROLLER - POWER	1	CWA744567	←	←	O
25	SENSOR COMPLETE	1	CWA50C2122	←	←	O
26	CONTROL BOARD FRONT COVER	1	CWH131207	←	←	
27	INDICATOR COMPLETE	1	CWE39C1168	←	←	O
28	INDICATOR HOLDER	1	CWD932744	←	←	
29	INDICATOR HOLDER	1	CWD932745	←	←	
30	CONTROL BOARD FRONT COVER CO.	1	CWH13C1171	←	←	
31	REMOTE CONTROL COMPLETE	1	CWA75C3006	←	←	O
32	FRONT GRILLE COMPLETE	1	CWE11C3676	←	←	O
33	INTAKE GRILLE COMPLETE	1	CWE22C1344	←	←	
34	GRILLE DOOR	1	CWE14C1010	←	←	
35	E-ION FILTER	2	CWD00K1001	←	←	
36	SCREW - FRONT GRILLE	2	XTT4+16CFJ	←	←	
37	CAP - FRONT GRILLE	2	CWH521109	←	←	
38	DRAIN HOSE	1	CWH851063	←	←	
39	INSTALLATION PLATE	1	CWH361067	←	←	
40	BAG COMPLETE - INSTALLATION SCREW	1	CWH82C067	←	←	
41	FULCRUM	1	CWH621049	←	←	
42	E-ION AIR PURIFYING SYSTEM	1	CWH14C5332	←	←	O
43	ION - GENERATOR	1	CWH94C0014	←	←	O

(NOTE)

- All parts are supplied from PHAAM, Malaysia (Vendor Code: 061).
- "O" marked parts are recommended to be kept in stock.

### 3.2. Outdoor Unit

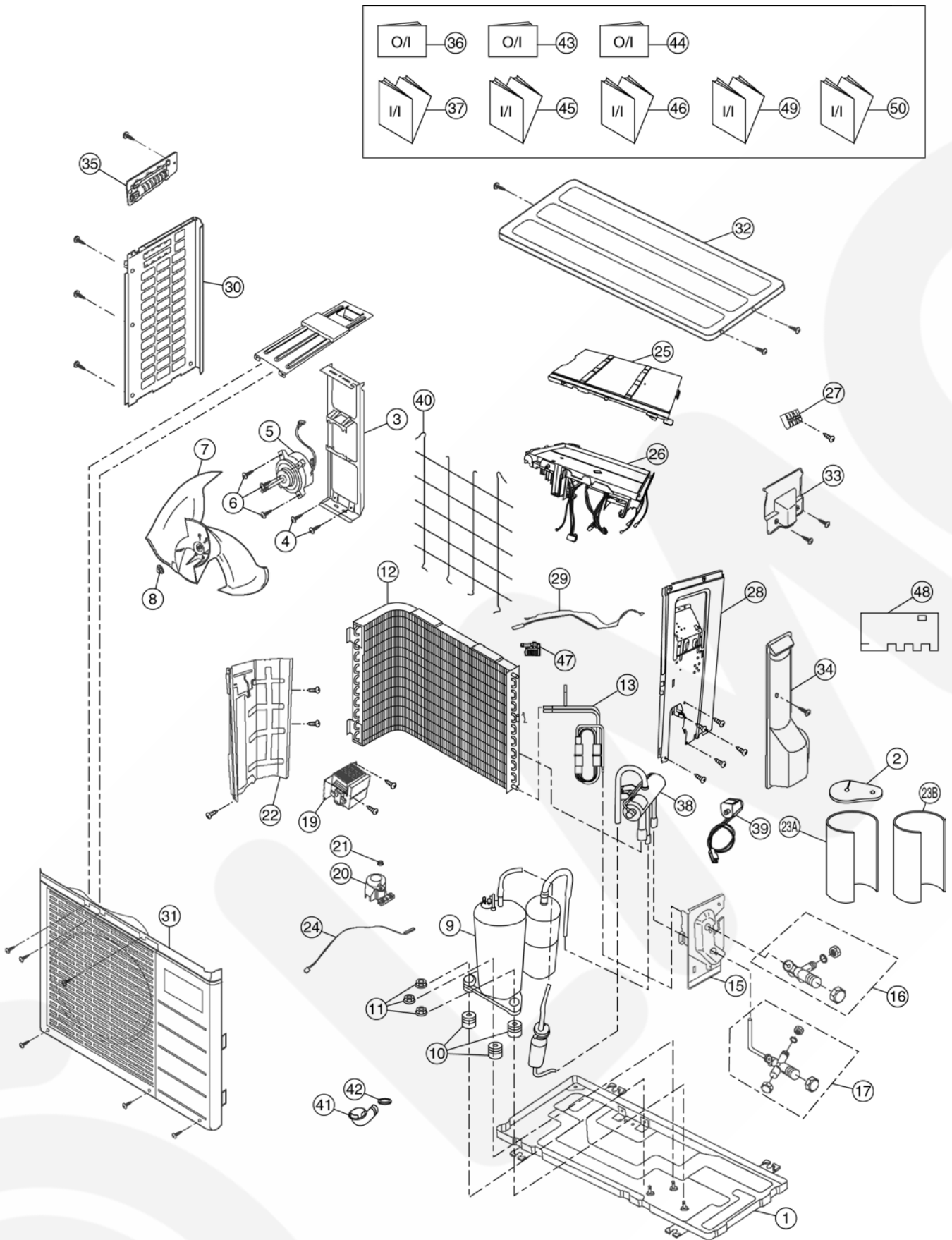

**Note**

The above exploded view is for the purpose of parts disassembly and replacement. The non-numbered parts are not kept as standard service parts.

REF. NO.	PART NAME & DESCRIPTION	QTY.	CU-CE7GKE	CU-CE9GKE	CU-CE12GKE	REMARKS
1	CHASSY ASS'Y	1	CWD50K2073	←	←	
2	SOUND PROOF MATERIAL	1	CWG302314	←	←	
3	FAN MOTOR BRACKET	1	CWD541030	←	←	
4	SCREW - FAN MOTOR BRACKET	2	CWH551198	←	←	
5	FAN MOTOR	1	CWA951536	CWA951553	CWA951542	O
6	SCREW - FAN MOTOR MOUNT	3	CWH55252J	←	←	
7	PROPELLER FAN ASS'Y	1	CWH03K1010	←	←	
8	NUT - PROPELLER FAN	1	CWH56053J	←	←	
9	COMPRESSOR	1	5RS092XCD01	5RS102XBC01	←	O
10	ANTI - VIBRATION BUSHING	3	CWH50077	←	←	
11	NUT - COMPRESSOR MOUNT	3	CWH56000J	←	←	
12	CONDENSER	1	CWB32C2154	CWB32C1599	←	
13	TUBE ASS'Y CO. (CAP. / CHK VALVE)	1	CWT01C4051	CWT01C4201	CWT01C4202	
15	HOLDER COUPLING	1	CWH351023	←	←	
16	2-WAYS VALVE (LIQUID)	1	CWB021301	←	←	O
17	3-WAYS VALVE (GAS)	1	CWB011374	←	CWB011367	O
19	REACTOR	1	G0C193J00003	←	G0C193J00004	O
20	TERMINAL COVER	1	CWH171039A	←	←	
21	NUT - TERMINAL COVER	1	CWH7080300J	←	←	
22	SOUND PROOF BOARD	1	CWH151172	←	←	
23A	SOUND PROOF MATERIAL	1	CWG302316	←	←	
23B	SOUND PROOF MATERIAL	1	CWG302317	←	←	
24	SENSOR COMPLETE	1	CWA50C2205	←	←	O
25	CONTROL BOARD COVER	1	CWH131264	←	←	
26	ELECTRONIC CONTROLLER - MAIN	1	CWA73C2542R	←	CWA73C2714R	O
27	TERMINAL BOARD ASS'Y	1	CWA28K1110J	←	←	O
28	CABINET SIDE PLATE CO.	1	CWE04C1116	←	←	
29	SENSOR COMPLETE	1	CWA50C2391	←	←	O
30	CABINET SIDE PLATE	1	CWE041248A	←	←	
31	CABINET FRONT PLATE CO.	1	CWE06C1039	CWE06C1136	←	
32	CABINET TOP PLATE	1	CWE031014A	←	←	
33	PLATE - C. B. COVER	1	CWH131301	←	←	
34	CONTROL BOARD COVER CO.	1	CWH13C1064	←	←	
35	HANDLE	1	CWE161010	←	←	
36	OPERATION INSTRUCTIONS (ENG., ESP., PRO., GRE.)	1	CWF565747	←	←	
37	INSTALLATION INSTRUCTION (ENG.)	1	CWF613297	←	←	
38	4-WAYS VALVE	1	CWB001037J	←	←	O
39	V - COIL COMPLETE	1	CWA43C2143J	←	←	O
40	WIRE NET	1	CWD041111A	←	←	
41	L - TUBE	1	CWH5850080	←	←	
42	PACKING - L. TUBE	1	CWB81012	←	←	
43	OPERATION INSTRUCTIONS (FRA., DEU., ITA., NED.)	1	-	CWF565748	←	
44	OPERATION INSTRUCTIONS (BUL., NOR., SWE.)	1	-	CWF565749	←	
45	INSTALLATION INSTRUCTION (FRA., DEU., ITA., NED.)	1	-	CWF613298	←	
46	INSTALLATION INSTRUCTION (POR., ESP., BUL., GRE.)	1	-	CWF613299	←	
47	HOLDER SENSOR	1	CWH321023	←	←	
48	SOUND PROOF MATERIAL	1	CWG302315	←	←	
49	INSTALLATION INSTRUCTION (NOR., SWE.)	1	CWF613300	←	←	
50	INSTALLATION INSTRUCTION (FIN., DAN.)	1	CWF613327	-	-	

(NOTE)

- All parts are supplied from PHAAM, Malaysia (Vendor Code: 061).
- "O" marked parts are recommended to be kept in stock.