

Service Manual

Air Conditioner

CS-HE9LKE CU-HE9LKE

CS-HE12LKE CU-HE12LKE

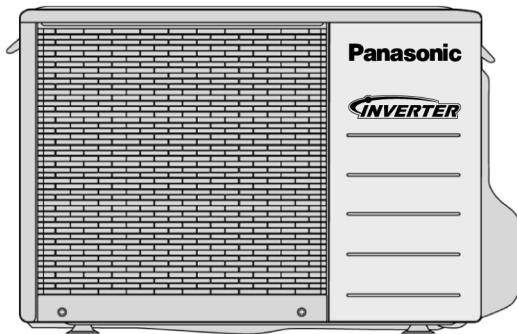
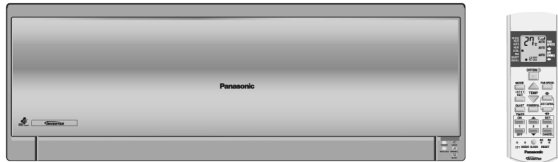

⚠ WARNING

This service information is designed for experienced repair technicians only and is not designed for use by the general public. It does not contain warnings or cautions to advise non-technical individuals of potential dangers in attempting to service a product. Products powered by electricity should be serviced or repaired only by experienced professional technicians. Any attempt to service or repair the product or products dealt with in this service information by anyone else could result in serious injury or death.

⚠ PRECAUTION OF LOW TEMPERATURE

In order to avoid frostbite, be assured of no refrigerant leakage during the installation or repairing of refrigeration circuit.

TABLE OF CONTENTS

	PAGE		PAGE
1 Safety Precautions -----	3	9.2. Outdoor Unit-----	20
2 Specifications -----	5	10 Printed Circuit Board -----	21
3 Features -----	11	10.1. Indoor Unit-----	21
4 Location of Controls and Components -----	12	10.2. Outdoor Unit-----	22
4.1. Product Overview-----	12	11 Installation Instruction -----	23
5 Dimensions -----	13	11.1. Select The Best Location-----	23
5.1. Indoor Unit-----	13	11.2. Indoor/Outdoor Unit Installation Diagram-----	23
5.2. Outdoor Unit-----	14	11.3. Indoor Unit-----	24
6 Refrigeration Cycle Diagram -----	15	11.4. Outdoor Unit-----	27
7 Block Diagram -----	16	12 Operation and Control -----	30
8 Wiring Connection Diagram -----	17	12.1. Basic Function-----	30
8.1. Indoor Unit-----	17	12.2. Indoor Fan Motor Operation-----	31
8.2. Outdoor Unit-----	18	12.3. Outdoor Fan Motor Operation-----	32
9 Electronic Circuit Diagram -----	19	12.4. Airflow Direction Control-----	33
9.1. Indoor Unit-----	19		

12.5. Quiet operation (Cooling Mode/Cooling area of Dry Mode)-----	35
12.6. Quiet operation (Heating) -----	36
12.7. Powerful Operation -----	36
12.8. Timer Control-----	37
12.9. Auto Restart Control-----	37
12.10. Indication Panel-----	37
12.11. +8/10°C Heat Operation-----	38
13 Protection Control-----	39
13.1. Protection Control For All Operations-----	39
13.2. Protection Control For Cooling -----	41
13.3. Protection Control For Heating Operation -----	42
14 Servicing Mode-----	43
14.1. Auto OFF/ON Button-----	43
14.2. Remote Control Button -----	44
15 Troubleshooting Guide-----	45
15.1. Refrigeration Cycle System -----	45
15.2. Breakdown Self Diagnosis Function -----	47
15.3. Error Codes Table-----	48
15.4. Self-diagnosis Method -----	49
16 Disassembly and Assembly Instructions-----	74
16.1. Indoor Electronic Controller, Cross Flow Fan and Indoor Fan Motor Removal Procedure-----	74
16.2. Disassembly of Outdoor Unit-----	82
17 Technical Data-----	85
17.1. Operation Characteristics -----	85
17.2. Airflow data -----	93
17.3. Sensible Capacity Chart-----	93
18 Exploded View and Replacement Parts List -----	94
18.1. Indoor Unit -----	94
18.2. Outdoor Unit-----	96

1 Safety Precautions

- Read the following "SAFETY PRECAUTIONS" carefully before perform any servicing.
- Electrical work must be installed or serviced by a licensed electrician. Be sure to use the correct rating of the power plug and main circuit for the model installed.
- The caution items stated here must be followed because these important contents are related to safety. The meaning of each indication used is as below. Incorrect installation or servicing due to ignoring of the instruction will cause harm or damage, and the seriousness is classified by the following indications.





 WARNING	This indication shows the possibility of causing death or serious injury.
--	---



 CAUTION	This indication shows the possibility of causing injury or damage to properties.
--	--

- The items to be followed are classified by the symbols:







	This symbol denotes item that is PROHIBITED from doing.
---	---

- Carry out test run to confirm that no abnormality occurs after the servicing. Then, explain to user the operation, care and maintenance as stated in instructions. Please remind the customer to keep the operating instructions for future reference.

 WARNING	
1. Do not modify the machine, part, material during repairing service.	
2. If wiring unit is supplied as repairing part, do not repair or connect the wire even only partial wire break. Exchange the whole wiring unit.	
3. Do not wrench the fasten terminal. Pull it out or insert it straightly.	
4. Engage dealer or specialist for installation and servicing. If installation of servicing done by the user is defective, it will cause water leakage, electrical shock or fire.	
5. Install according to this installation instructions strictly. If installation is defective, it will cause water leakage, electric shock or fire.	
6. Use the attached accessories parts and specified parts for installation and servicing. Otherwise, it will cause the set to fall, water leakage, fire or electrical shock.	
7. Install at a strong and firm location which is able to withstand the set's weight. If the strength is not enough or installation is not properly done, the set will drop and cause injury.	
8. For electrical work, follow the local national wiring standard, regulation and the installation instruction. An independent circuit and single outlet must be used. If electrical circuit capacity is not enough or defect found in electrical work, it will cause electrical shock or fire.	
9. This equipment is strongly recommended to install with Earth Leakage Circuit Breaker (ELCB) or Residual Current Device (RCD). Otherwise, it may cause electrical shock and fire in case equipment breakdown or insulation breakdown.	
10. Do not use joint cable for indoor / outdoor connection cable. Use the specified indoor / outdoor connection cable, refer to installation instruction CONNECT THE CABLE TO THE INDOOR UNIT and connect tightly for indoor / outdoor connection. Clamp the cable so that no external force will be acted on the terminal. If connecting or fixing is not perfect, it will cause heat up or fire at the connection.	
11. Wire routing must be properly arranged so that control board cover is fixed properly. If control board cover is not fixed perfectly, it will cause heat-up or fire at the connection point of terminal, fire or electrical shock.	
12. When install or relocate air conditioner, do not let any substance other than the specified refrigerant, eg. air etc. mix into refrigeration cycle (piping). (Mixing of air etc. will cause abnormal high pressure in refrigeration cycle and result in explosion, injury etc.)	
13. Do not install outdoor unit near handrail of veranda. When installing air-conditioner unit at veranda of high rise building, child may climb up to outdoor unit and cross over the handrail and causing accident.	
14. This equipment must be properly earthed. Earth line must not be connected to gas pipe, water pipe, earth of lightning rod and telephone. Otherwise, it may cause electric shock in case equipment breakdown or insulation breakdown.	
15. Keep away from small children, the thin film may cling to nose and mouth and prevent breathing.	
16. Do not use unspecified cord, modified cord, joint cord or extension cord for power supply cord. Do not share the single outlet with other electrical appliances. Poor contact, poor insulation or over current will cause electrical shock or fire.	
17. Tighten the flare nut with torque wrench according to specified method. If the flare nut is over-tightened, after a long period, the flare may break and cause refrigerant gas leakage.	

18. For R410A models, when connecting the piping, do not use any existing (R22) pipes and flare nuts. Using such same may cause abnormally highpressure in the refrigeration cycle (piping), and possibly result in explosion and injury. Use only R410A materials. Thickness or copper pipes used with R410A must be more than 0.8 mm. Never use copper pipes thinner than 0.8 mm. It is desirable that the amount of residual oil is less than 40 mg/10 m.	
19. During installation, install the refrigerant piping properly before run the compressor. (Operation of compressor without fixing refrigeration piping and valves at opened condition will cause suck-in of air, abnormal high pressure in refrigeration cycle and result in explosion, injury etc.)	
20. During pump down operation, stop the compressor before remove the refrigerant piping. (Removal of refrigeration piping while compressor is operating and valves are opened condition will cause suck-in of air, abnormal high pressure in refrigeration cycle and result in explosion, injury etc.).	
21. After completion of installation or service, confirm there is no leakage of refrigerant gas. It may generate toxic gas when the refrigerant contacts with fire.	
22. Ventilate if there is refrigerant gas leakage during operation. It may cause toxic gas when refrigerant contacts with fire.	
23. Do not insert your fingers or other objects into the unit, high speed rotating fan may cause injury.	
24. Must not use other parts except original parts describe in catalog and manual.	

CAUTION

1. Do not install the unit at place where leakage of flammable gas may occur. In case gas leaks and accumulates at surrounding of the unit, it may cause fire.	
2. Carry out drainage piping as mentioned in installation instructions. If drainage is not perfect, water may enter the room and damage the furniture.	
3. Tighten the flare nut with torque wrench according to specified method. If the flare nut is over-tightened, after a long period, the flare may break and cause refrigerant gas leakage.	
4. Do not touch outdoor unit air inlet and aluminium fin. It may cause injury.	
5. Select an installation location which is easy for maintenance.	
6. Pb free solder has a higher melting point than standard solder; typically the melting point is 50°F - 70°F (30°C - 40°C) higher. Please use a high temperature solder iron. In case of the soldering iron with temperature control, please set it to 700 ± 20°F (370 ± 10°C). Pb free solder will tend to splash when heated too high (about 1100°F / 600°C).	
7. Power supply connection to the air conditioner. Connect the power supply cord of the air conditioner to the mains using one of the following methods. Power supply point shall be the place where there is ease for access for the power disconnection in case of emergency. In some countries, permanent connection of this room air conditioner to the power supply is prohibited. i. Power supply connection to the receptacle using a power plug. Use an approved 15/16A (1.0 ~1.75HP), 16A (2.0HP), 20A (2.5HP) power plug with earth pin for the connection to the socket. ii. Power supply connection to a circuit breaker for the permanent connection. Use an approved 16A (1.0~2.0HP) or 20A (2.5HP) circuit breaker for the permanent connection. It must be a double pole switch with a minimum 3.0 mm contact gap.	
8. Do not release refrigerant during piping work for installation, servicing, reinstallation and during repairing a refrigerant parts. Take care of the liquid refrigerant, it may cause frostbite.	
9. Installation or servicing work: It may need two people to carry out the installation or servicing work.	
10. Do not install this appliance in a laundry room or other location where water may drip from the ceiling, etc.	
11. Do not sit or step on the unit, you may fall down accidentally.	
12. Do not touch the sharp aluminum fins or edges of metal parts. If you are required to handle sharp parts during installation or servicing, please wear hand glove. Sharp parts may cause injury.	

2 Specifications

MODEL			INDOOR	CS-HE9LKE		
			OUTDOOR	CU-HE9LKE		
Performance Test Condition				EUROVENT		
Power Supply			Phase, Hz	Single, 50		
			V	230		
				Min.	Mid.	Max.
Cooling	Capacity		kW	0.60	2.50	3.00
			kcal/h	520	2150	2580
	Running Current		A	—	2.3	—
	Input Power		W	120	480	700
	Annual Consumption		kWh	—	240	—
	EER		W/W	5.00	5.21	4.29
			kcal/hW	4.33	4.48	3.69
	Power Factor		%	—	91	—
	Indoor Noise (H / L / QLo)		dB-A	39 / 26 / 23		
			Power Level dB	55 / 42 / 39		
Outdoor Noise (H / L)		dB-A	46 / -			
		Power Level dB	61 / -			
Heating	Capacity		kW	0.60	3.20	6.50
			kcal/h	520	2750	5590
	Running Current		A	—	2.8	—
	Input Power		W	115	580	1.72k
	COP		W/W	5.22	5.52	3.78
			kcal/hW	4.52	4.74	3.25
	Power Factor		%	—	90	—
	Indoor Noise (H / L / QLo)		dB-A	42 / 27 / 24		
			Power Level dB	58 / 43 / 40		
	Outdoor Noise (H / L)		dB-A	47 / -		
Power Level dB			62 / -			
Low Temp. : Capacity (kW) / I.Power (W) / COP				4.71 / 1.52 / 3.10		
Extr Low Temp. : Capacity (kW) / I.Power (W) / COP				3.70 / 1.58 / 2.34		
Max Current (A) / Max Input Power (W)				8.0 / 1.72k		
Starting Current (A)				2.8		
Compressor		Type	Hermetic Motor			
		Motor Type	Brushless (4-poles)			
		Output Power	W	750		
Indoor Fan	Type		Cross-flow Fan			
	Material		ASG30K1			
	Motor Type		Transistor (8-poles)			
	Input Power		W	24.5		
	Output Power		W	30		
	Speed	QLo	Cool	rpm	560	
			Heat	rpm	650	
		Lo	Cool	rpm	660	
			Heat	rpm	750	
		Me	Cool	rpm	880	
			Heat	rpm	990	
		Hi	Cool	rpm	1090	
			Heat	rpm	1230	
SHi	Cool	rpm	1170			
	Heat	rpm	1230			

MODEL				INDOOR	CS-HE9LKE		
				OUTDOOR	CU-HE9LKE		
Outdoor Fan	Type			Propeller Fan			
	Material			PP			
	Motor Type			DC (8-poles)			
	Input Power		Cool	W	—		
			Heat	W	—		
	Output Power			W	40		
Speed	Hi	Cool	rpm	790			
		Heat	rpm	770			
Moisture Removal			L/h (Pt/h)	1.5 (3.2)			
Indoor Airflow		QLo	Cool	m ³ /min (ft ³ /min)	4.2 (148)		
			Heat	m ³ /min (ft ³ /min)	5.3 (187)		
		Lo	Cool	m ³ /min (ft ³ /min)	5.4 (190)		
			Heat	m ³ /min (ft ³ /min)	6.4 (226)		
		Me	Cool	m ³ /min (ft ³ /min)	8.0 (283)		
			Heat	m ³ /min (ft ³ /min)	9.3 (328)		
		Hi	Cool	m ³ /min (ft ³ /min)	10.5 (370)		
			Heat	m ³ /min (ft ³ /min)	12.5 (440)		
SHi	Cool	m ³ /min (ft ³ /min)	11.4 (403)				
	Heat	m ³ /min (ft ³ /min)	12.5 (440)				
Outdoor Airflow		Hi	Cool	m ³ /min (ft ³ /min)	23.8 (840)		
			Heat	m ³ /min (ft ³ /min)	22.8 (800)		
Refrigeration Cycle		Control Device		Expansion Valve			
		Refrigerant Oil		cm ³		RB68A or Freol Alpha 68M (400)	
		Refrigerant Type		g (oz)		R410A, 1330 (46.9)	
Dimension		Height (I/D / O/D)		mm (inch)		298 (11-23/32) / 540 (21-1/4)	
		Width (I/D / O/D)		mm (inch)		870 (34-1/4) / 780 (30-23/32)	
		Depth (I/D / O/D)		mm (inch)		199 (7-27/32) / 289 (11-3/8)	
Weight		Net (I/D / O/D)		kg (lb)		12 (26) / 37 (82)	
Piping	Pipe Diameter (Liquid / Gas)			mm (inch)		6.35 (1/4) / 9.52 (3/8)	
	Standard Length			m (ft)		5 (16.4)	
	Length Range (min - max)			m (ft)		3 (9.8) ~ 15 (49.2)	
	I/D & O/D Height Different			m (ft)		5.0 (16.4)	
	Additional Gas Amount			g/m (oz/ft)		20 (0.2)	
	Length for Additional Gas			m (ft)		7.5 (24.6)	
Drain Hose		Inner Diameter		mm		16	
		Length		mm		650	
Indoor Heat Exchanger		Fin Material		Aluminium (Pre Coat)			
		Fin Type		Slit Fin			
		Row x Stage x FPI		15 (Front) 3 x 18 (Middle) x 19.5 17 (Back)			
		Size (W x H x L)		mm		671 x 332.6 x 30.9	
Outdoor Heat Exchanger		Fin Material		Aluminium			
		Fin Type		Corrugated Fin			
		Row x Stage x FPI		2 x 24 x 17			
		Size (W x H x L)		mm		36.4 x 504 x 836.2 824.2	
e-ion Filter		Material		Polypropelene			
		Type		One-touch			
Power Supply				Outdoor Power Supply			
Power Supply Cord				A		Nil	
Thermostat				Electronic Control			

MODEL		INDOOR	CS-HE9LKE	
		OUTDOOR	CU-HE9LKE	
Protection Device			Electronic Control	
			Dry Bulb	Wet Bulb
Indoor Operation Range	Cooling	Maximum	32	23
		Minimum	16	11
	Heating	Maximum	30	—
		Minimum	16	—
	+8/10°C HEAT	Maximum	10	—
		Minimum	8	—
Outdoor Operation Range	Cooling	Maximum	43	26
		Minimum	16	11
	Heating	Maximum	24	18
		Minimum	-15	—
	+8/10°C HEAT	Maximum	—	—
		Minimum	-15	—

1. Cooling capacities are based on indoor temperature of 27°C Dry Bulb (80.6°F Dry Bulb), 19.0°C Wet Bulb (66.2°F Wet Bulb) and outdoor air temperature of 35°C Dry Bulb (95°F Dry Bulb), 24°C Wet Bulb (75.2°F Wet Bulb)
2. Heating capacities are based on indoor temperature of 20°C Dry Bulb (68°F Dry Bulb) and outdoor air temperature of 7°C Dry Bulb (44.6°F Dry Bulb), 6°C Wet Bulb (42.8°F Wet Bulb)
3. Heating low temperature capacity, Input Power and COP measured at 230 V, indoor temperature 20°C, outdoor 2/1°C
4. Heating extreme low temperature capacity, Input Power and COP measured at 230 V, indoor temperature 20°C, outdoor -7/-8°C
5. Specifications are subjected to change without prior notice for further improvement.
6. Maximum heating capacity shown are the values based on powerful operation.

MODEL		INDOOR		CS-HE12LKE		
		OUTDOOR		CU-HE12LKE		
Performance Test Condition				EUROVENT		
Power Supply		Phase, Hz		Single, 50		
		V		230		
			Min.	Mid.	Max.	
Cooling	Capacity		kW	0.60	3.50	4.00
			kcal/h	520	3010	3440
	Running Current		A	—	4.2	—
	Input Power		W	120	880	1.05k
	Annual Consumption		kWh	—	440	—
	EER		W/W	5.00	3.98	3.81
			kcal/hW	4.33	3.42	3.28
	Power Factor		%	—	91	—
	Indoor Noise (H / L / QLo)		dB-A	42 / 29 / 26		
			Power Level dB	58 / 45 / 42		
Outdoor Noise (H / L)		dB-A	48 / -			
		Power Level dB	63 / -			
Heating	Capacity		kW	0.60	4.20	7.70
			kcal/h	520	3610	6620
	Running Current		A	—	4.0	—
	Input Power		W	115	850	2.28k
	COP		W/W	5.22	4.94	3.38
			kcal/hW	4.52	4.25	2.90
	Power Factor		%	—	92	—
	Indoor Noise (H / L / QLo)		dB-A	44 / 33 / 30		
			Power Level dB	60 / 49 / 46		
	Outdoor Noise (H / L)		dB-A	50 / -		
Power Level dB			65 / -			
Low Temp. : Capacity (kW) / I.Power (W) / COP				5.58 / 2.02 / 2.76		
Extr Low Temp. : Capacity (kW) / I.Power (W) / COP				4.40 / 2.06 / 2.14		
Max Current (A) / Max Input Power (W)				10.6 / 2.28k		
Starting Current (A)				4.2		
Compressor		Type		Hermetic Motor		
		Motor Type		Brushless (4-poles)		
		Output Power		W	750	
Indoor Fan	Type		Cross-flow Fan			
	Material		ASG30K1			
	Motor Type		Transistor (8-poles)			
	Input Power		W	24.5		
	Output Power		W	30		
	Speed	QLo	Cool	rpm	640	
			Heat	rpm	770	
		Lo	Cool	rpm	740	
			Heat	rpm	870	
		Me	Cool	rpm	920	
			Heat	rpm	1090	
		Hi	Cool	rpm	1110	
			Heat	rpm	1310	
SHi		Cool	rpm	1210		
		Heat	rpm	1310		

MODEL			INDOOR	CS-HE12LKE
			OUTDOOR	CU-HE12LKE
Outdoor Fan	Type			Propeller Fan
	Material			PP
	Motor Type			DC (8-poles)
	Input Power	Cool	W	—
		Heat	W	—
	Output Power		W	40
Speed	Hi	Cool	rpm	790
		Heat	rpm	810
Moisture Removal			L/h (Pt/h)	2.0 (4.2)
Indoor Airflow	QLo	Cool	m ³ /min (ft ³ /min)	5.1 (180)
		Heat	m ³ /min (ft ³ /min)	6.7 (237)
	Lo	Cool	m ³ /min (ft ³ /min)	6.3 (222)
		Heat	m ³ /min (ft ³ /min)	7.9 (279)
	Me	Cool	m ³ /min (ft ³ /min)	8.5 (300)
		Heat	m ³ /min (ft ³ /min)	10.5 (370)
	Hi	Cool	m ³ /min (ft ³ /min)	11.3 (400)
		Heat	m ³ /min (ft ³ /min)	13.5 (480)
SHi	Cool	m ³ /min (ft ³ /min)	11.9 (420)	
	Heat	m ³ /min (ft ³ /min)	13.5 (480)	
Outdoor Airflow	Hi	Cool	m ³ /min (ft ³ /min)	23.8 (840)
		Heat	m ³ /min (ft ³ /min)	24.8 (880)
Refrigeration Cycle	Control Device			Expansion Valve
	Refrigerant Oil		cm ³	RB68A or Freol Alpha 68M (400)
	Refrigerant Type		g (oz)	R410A, 1330 (46.9)
Dimension	Height (I/D / O/D)		mm (inch)	298 (11-23/32) / 540 (21-1/4)
	Width (I/D / O/D)		mm (inch)	870 (34-1/4) / 780 (30-23/32)
	Depth (I/D / O/D)		mm (inch)	199 (7-27/32) / 289 (11-3/8)
Weight	Net (I/D / O/D)		kg (lb)	12 (26) / 37 (82)
Piping	Pipe Diameter (Liquid / Gas)		mm (inch)	6.35 (1/4) / 9.52 (3/8)
	Standard Length		m (ft)	5 (16.4)
	Length Range (min - max)		m (ft)	3 (9.8) ~ 15 (49.2)
	I/D & O/D Height Different		m (ft)	5 (16.4)
	Additional Gas Amount		g/m (oz/ft)	20 (0.2)
	Length for Additional Gas		m (ft)	7.5 (24.6)
Drain Hose	Inner Diameter		mm	16
	Length		mm	650
Indoor Heat Exchanger	Fin Material			Aluminium (Pre Coat)
	Fin Type			Slit Fin
	Row x Stage x FPI			15 (Front) 3 x 18 (Middle) x 19.5 17 (Back)
	Size (W x H x L)		mm	671 x 332.6 x 30.9
Outdoor Heat Exchanger	Fin Material			Aluminium
	Fin Type			Corrugated Fin
	Row x Stage x FPI			2 x 24 x 17
	Size (W x H x L)		mm	36.4 x 504 x 836.2 824.2
e-ion Filter	Material			Polypropelene
	Type			One-touch
Power Supply				Outdoor Power Supply
Power Supply Cord			A	Nil
Thermostat				Electronic Control

MODEL		INDOOR	CS-HE12LKE	
		OUTDOOR	CU-HE12LKE	
Protection Device			Electronic Control	
			Dry Bulb	Wet Bulb
Indoor Operation Range	Cooling	Maximum	32	23
		Minimum	16	11
	Heating	Maximum	30	—
		Minimum	16	—
	+8/10°C HEAT	Maximum	10	—
		Minimum	8	—
Outdoor Operation Range	Cooling	Maximum	43	26
		Minimum	16	11
	Heating	Maximum	24	18
		Minimum	-15	—
	+8/10°C HEAT	Maximum	—	—
		Minimum	-15	—

1. Cooling capacities are based on indoor temperature of 27°C Dry Bulb (80.6°F Dry Bulb), 19.0°C Wet Bulb (66.2°F Wet Bulb) and outdoor air temperature of 35°C Dry Bulb (95°F Dry Bulb), 24°C Wet Bulb (75.2°F Wet Bulb)
2. Heating capacities are based on indoor temperature of 20°C Dry Bulb (68°F Dry Bulb) and outdoor air temperature of 7°C Dry Bulb (44.6°F Dry Bulb), 6°C Wet Bulb (42.8°F Wet Bulb)
3. Heating low temperature capacity, Input Power and COP measured at 230 V, indoor temperature 20°C, outdoor 2/1°C
4. Heating extreme low temperature capacity, Input Power and COP measured at 230 V, indoor temperature 20°C, outdoor -7/-8°C
5. Specifications are subjected to change without prior notice for further improvement.
6. Maximum heating capacity shown are the values based on powerful operation.

3 Features

- **Inverter Technology**

- Wider output power range
- Energy saving
- More precise temperature control

- **E-ion Air Purifying System with Patrol Sensor**

- Active e-ions are released to catch dust particles and bring them back the large positively charged filter

- **Environment Protection**

- Non-ozone depletion substances refrigerant (R410A)

- **Long Installation Piping**

- Long piping up to 15 meters during single split connection only

- **Easy to use remote control**

- **Quality Improvement**

- Random auto restart after power failure for safety restart operation
- Gas leakage protection
- Prevent compressor reverse cycle
- Inner protector to protect Compressor
- Noise prevention during soft dry operation

- **Operation Improvement**

- Quiet mode to reduce the indoor unit operating sound
- Powerful mode to reach the desired room temperature quickly
- 24-hour timer setting
- +8/10°C HEAT operation is designed to provide heating at low temperature settings. It is used in houses unoccupied during winter, for the purpose of protecting equipment or housing appliances which may be destroyed by extreme cold weather.

- **Serviceability Improvement**

- Breakdown Self Diagnosis function

4 Location of Controls and Components

4.1. Product Overview

4.1.1. Indoor Unit

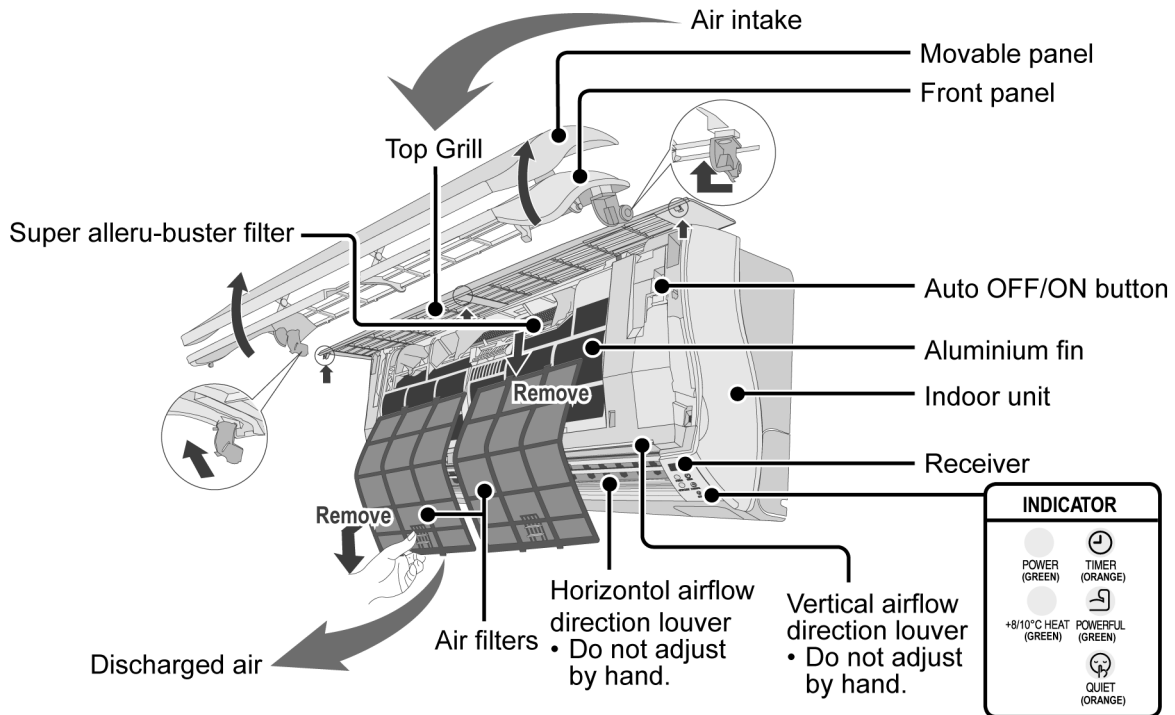

4.1.2. Outdoor Unit

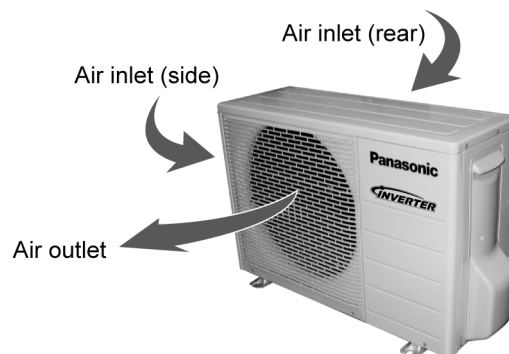

4.1.3. Remote Control

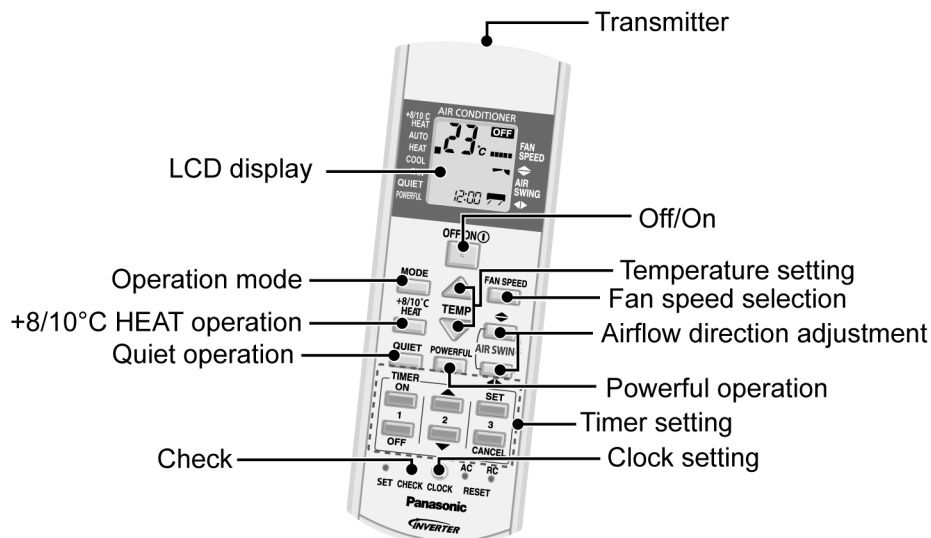

5 Dimensions

5.1. Indoor Unit

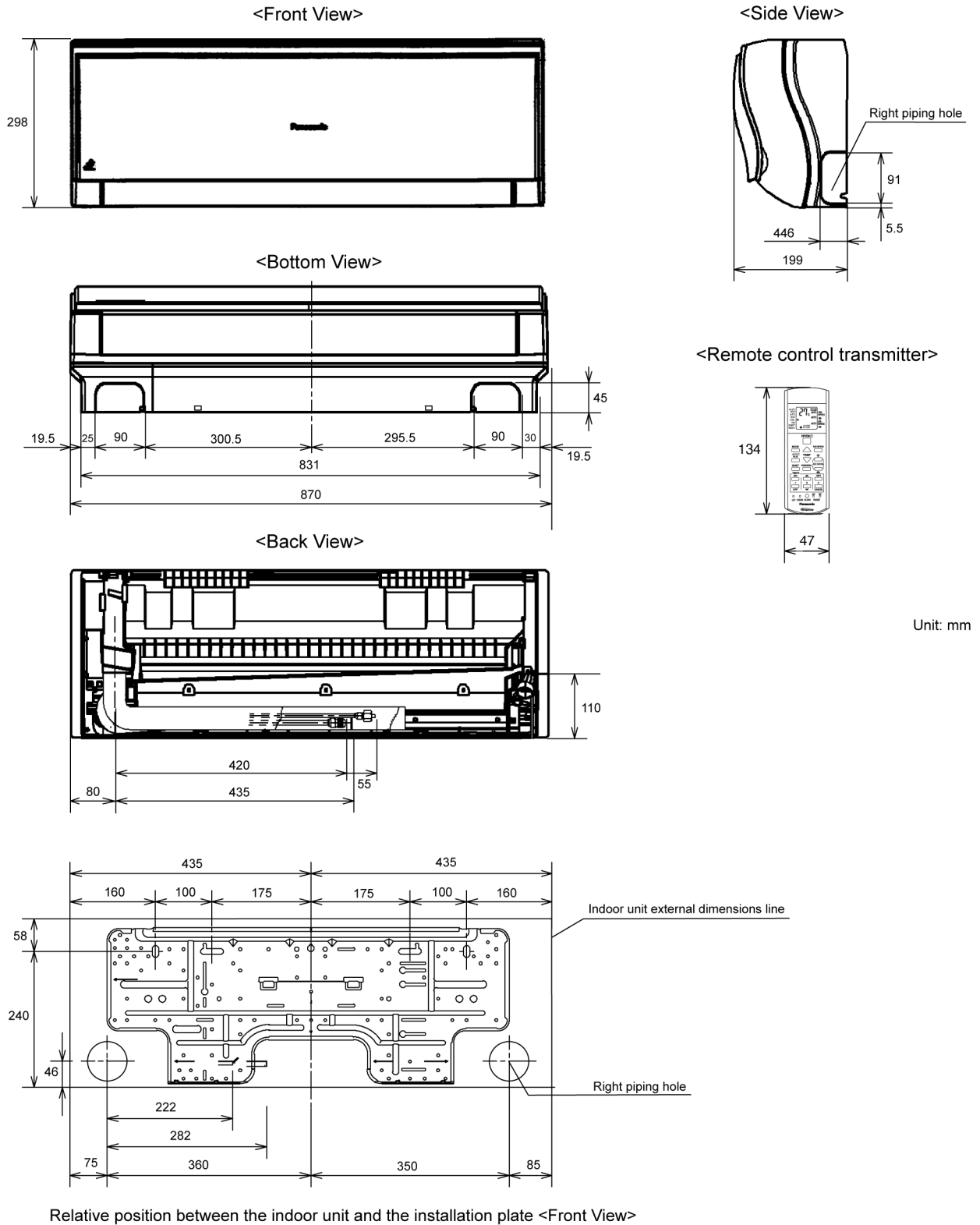

5.2. Outdoor Unit

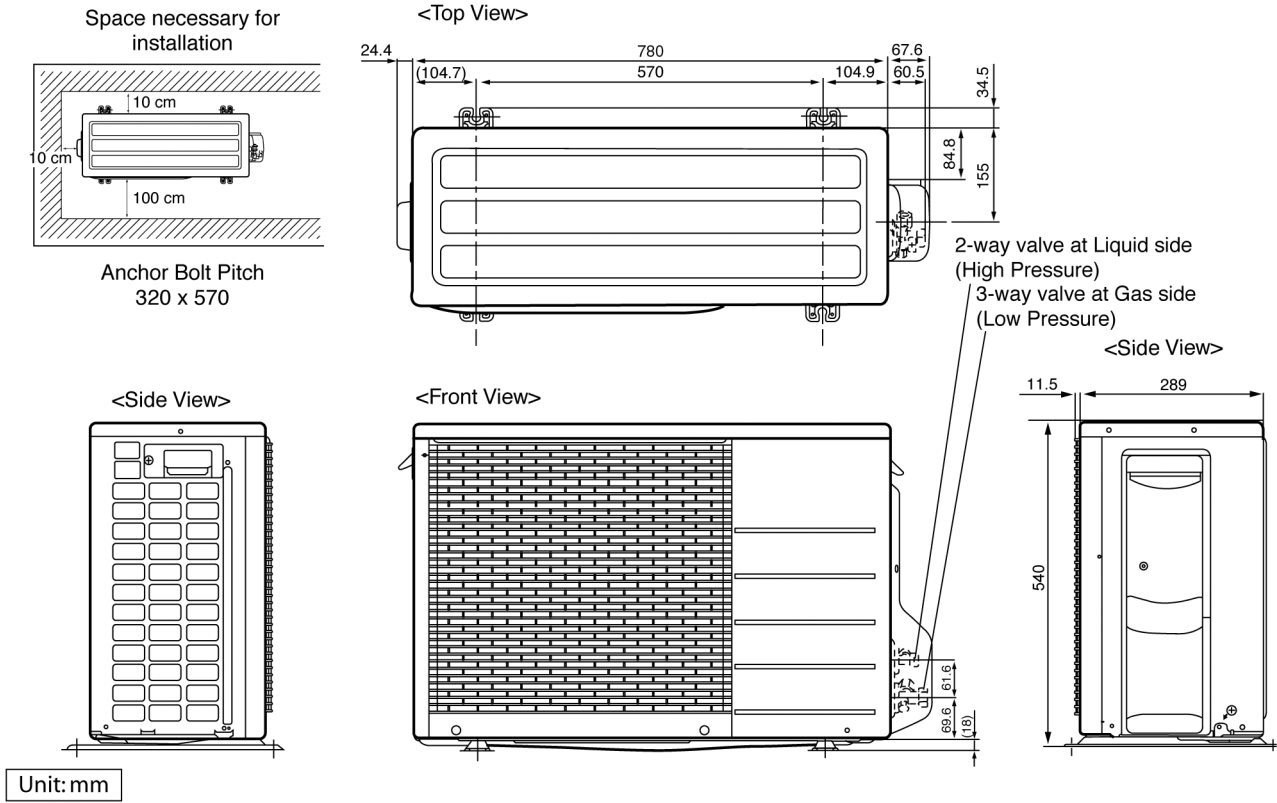

6 Refrigeration Cycle Diagram

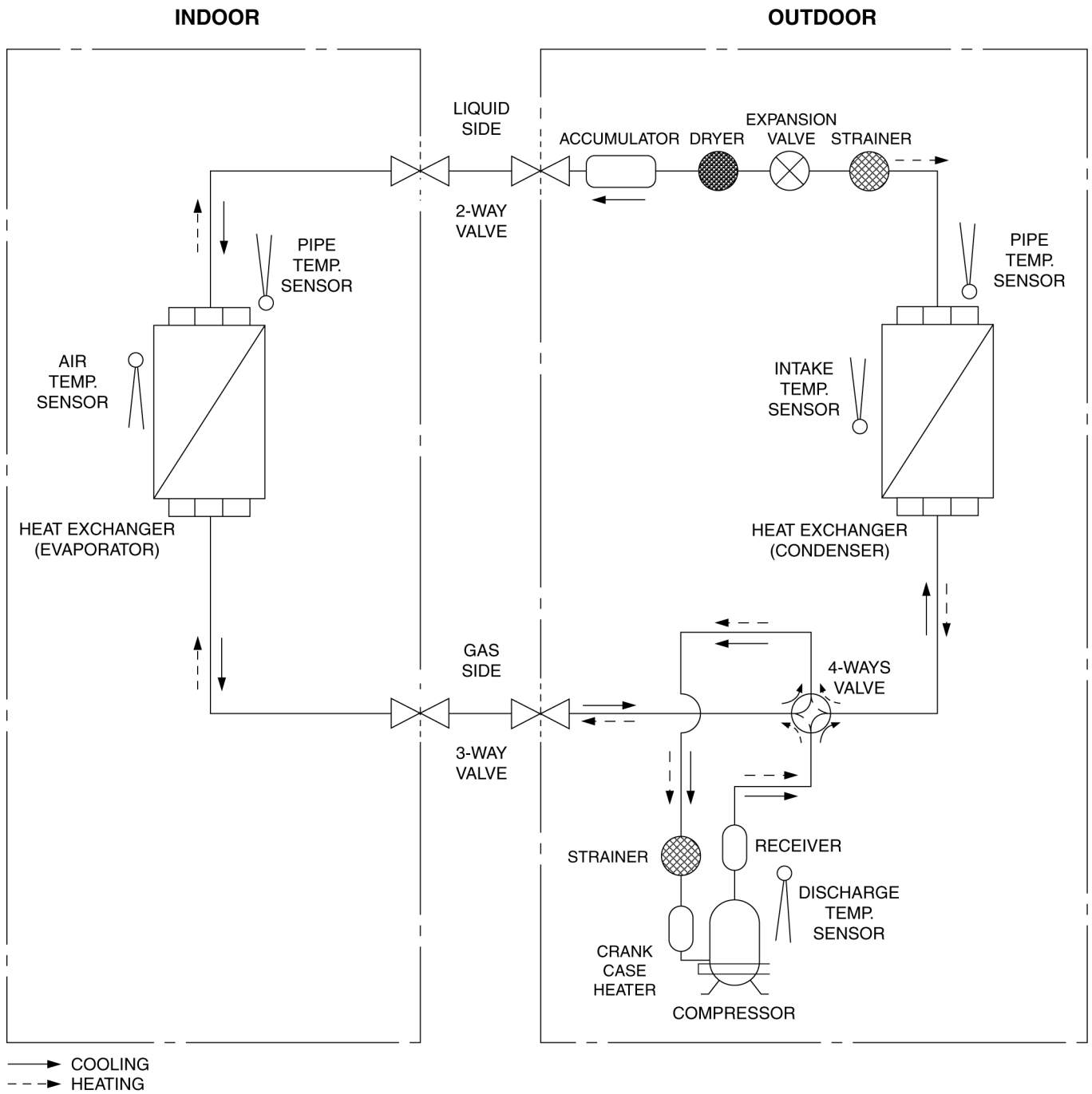

7 Block Diagram

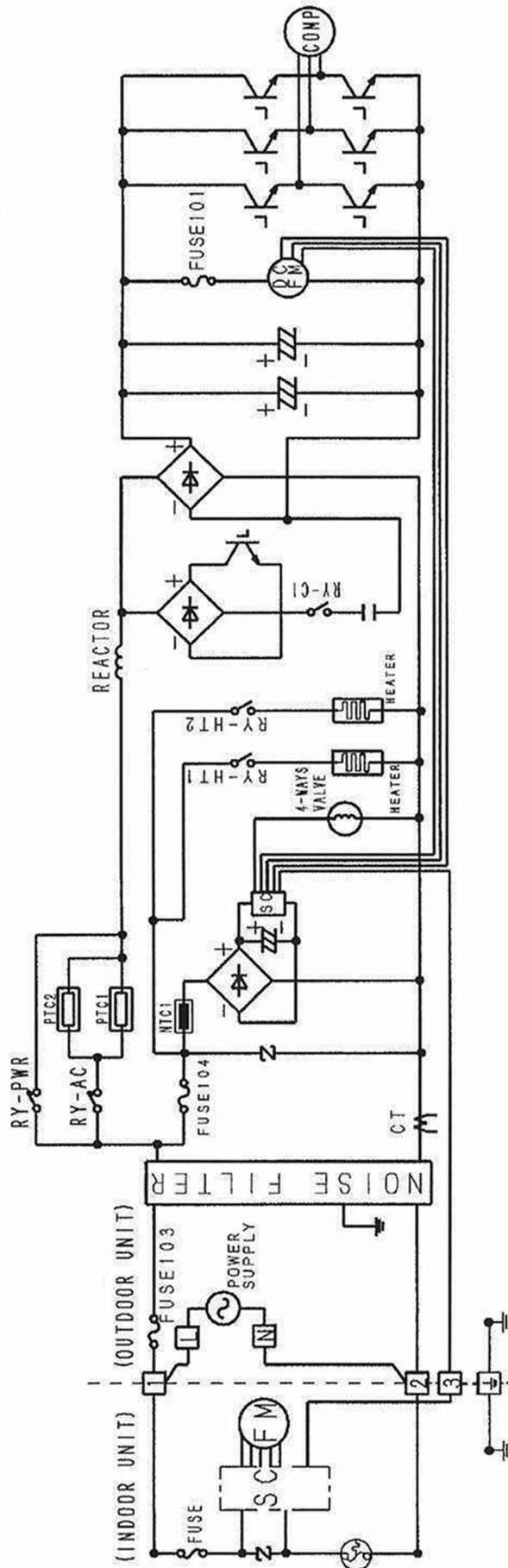

8 Wiring Connection Diagram

8.1. Indoor Unit

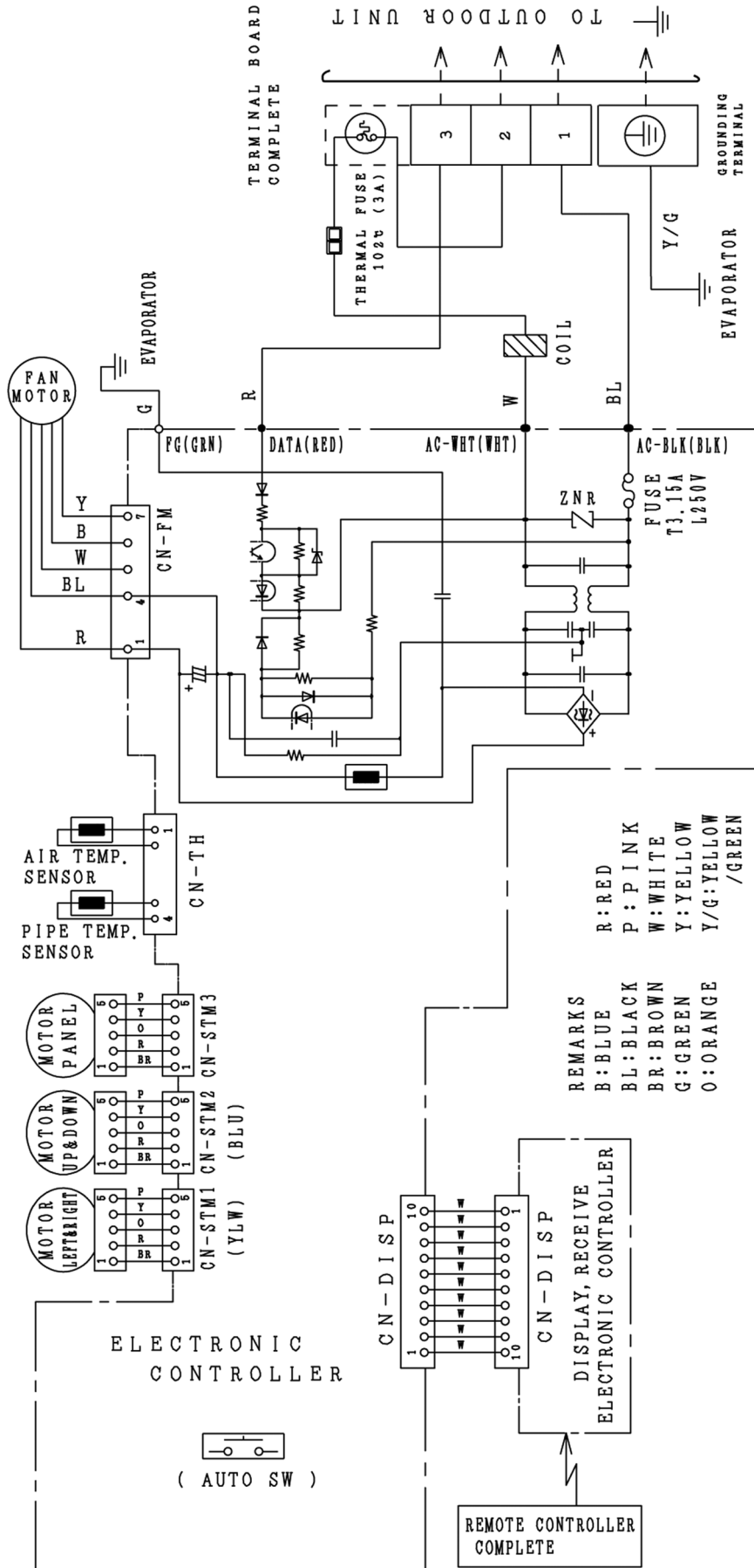

8.2. Outdoor Unit

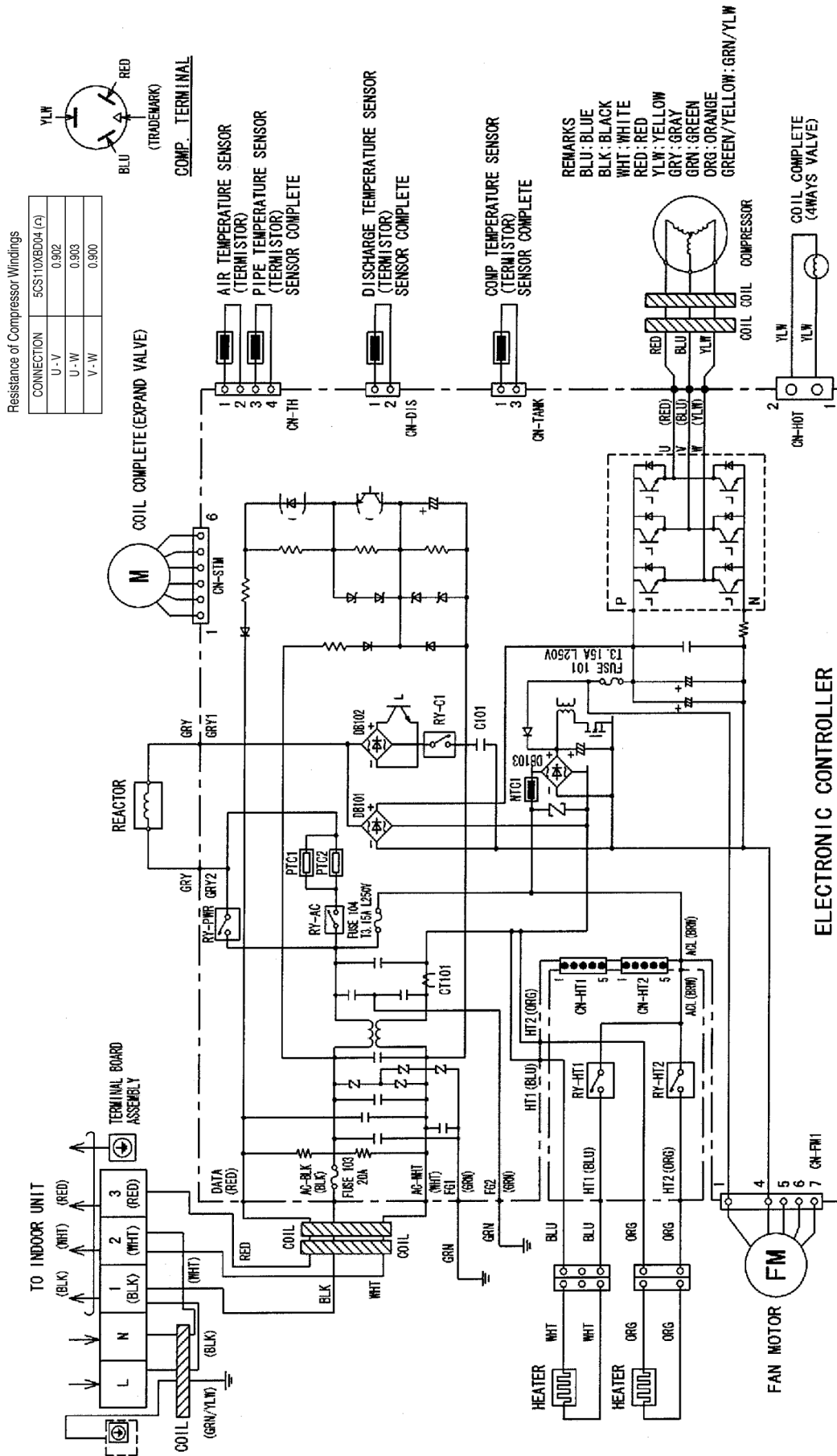

9 Electronic Circuit Diagram

9.1. Indoor Unit

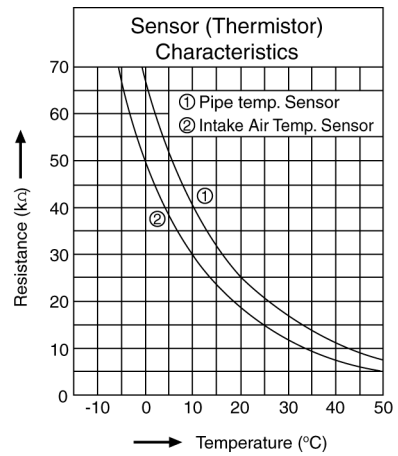
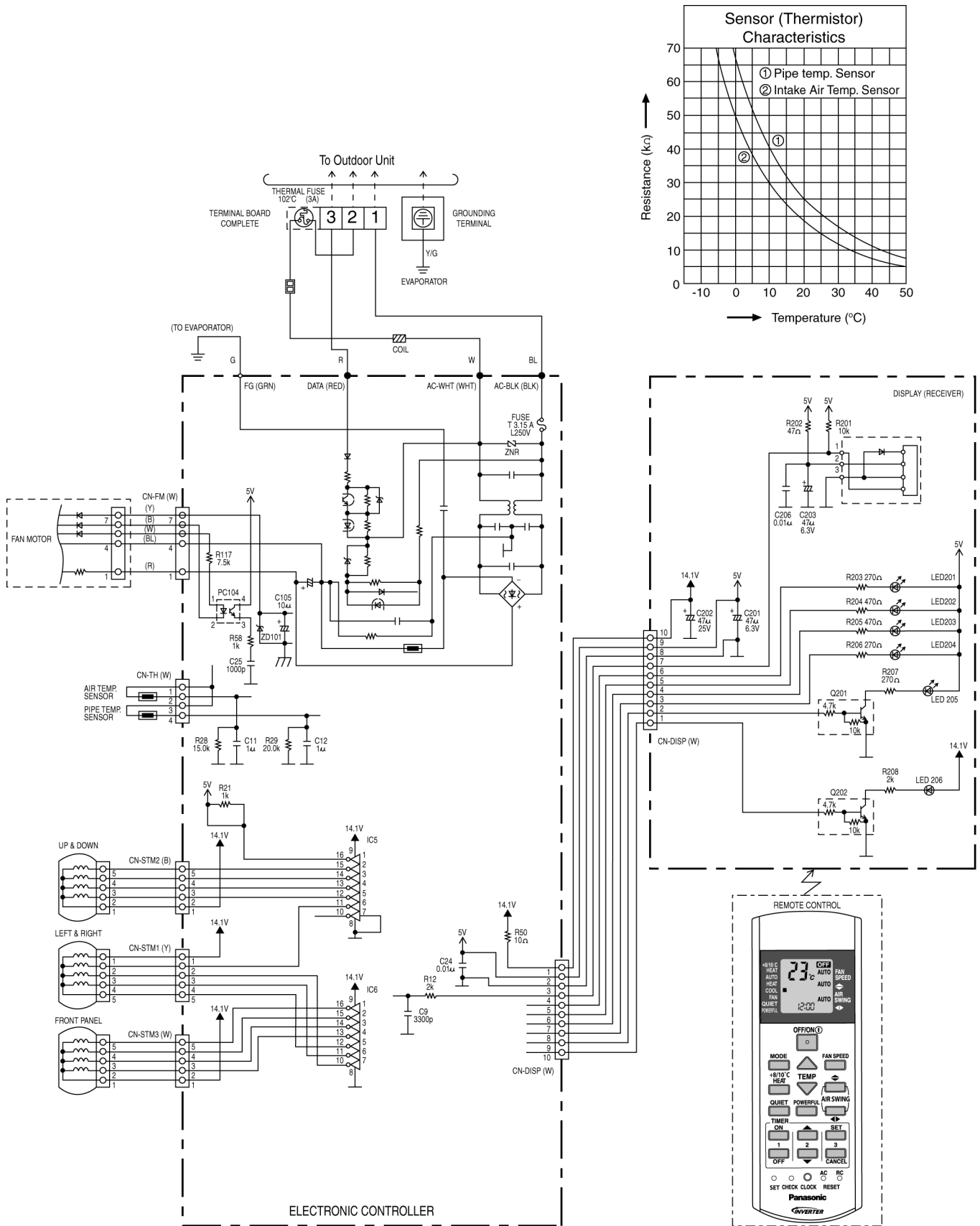

9.2. Outdoor Unit

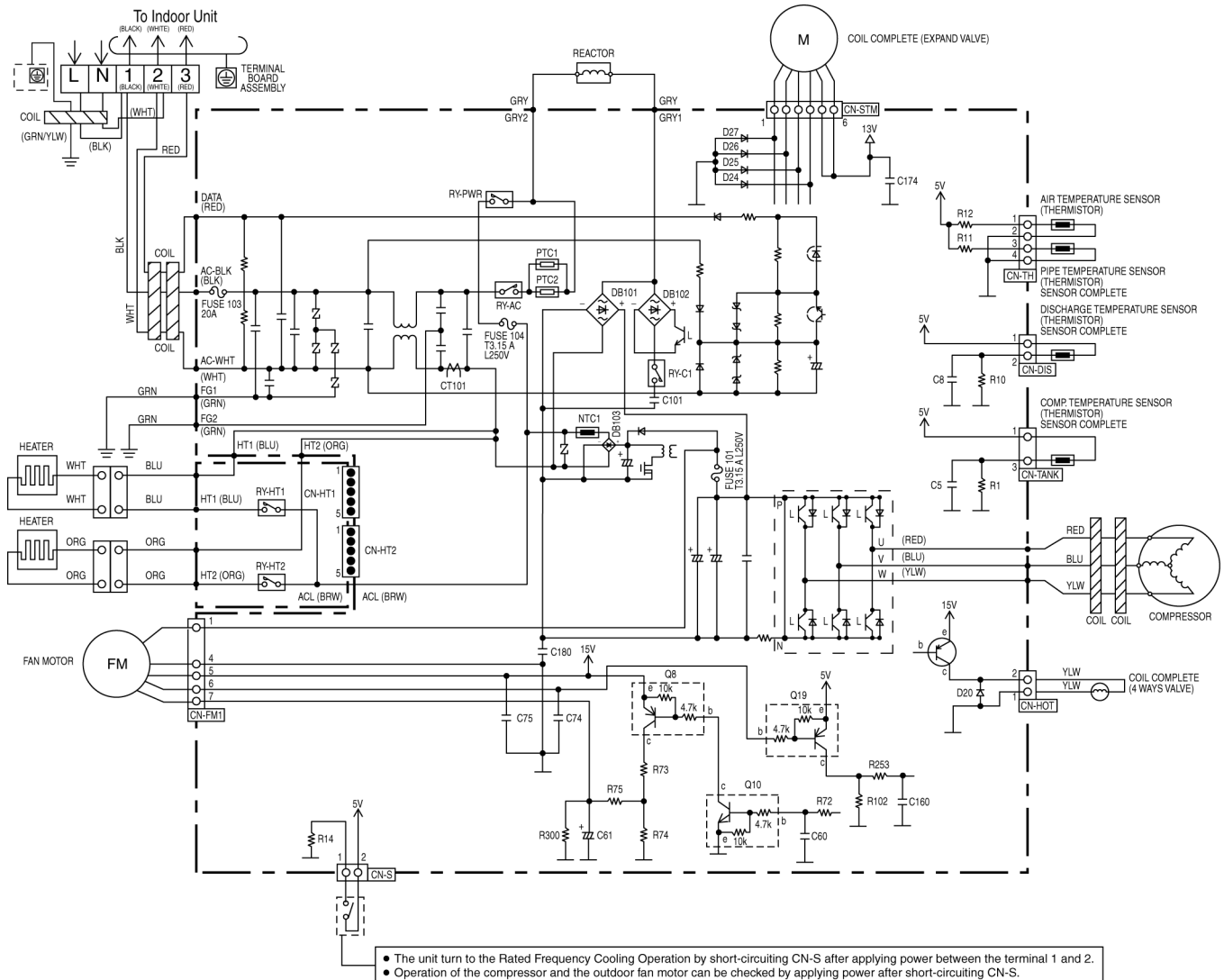

- The unit turn to the Rated Frequency Cooling Operation by short-circuiting CN-S after applying power between the terminal 1 and 2.
- Operation of the compressor and the outdoor fan motor can be checked by applying power after short-circuiting CN-S.

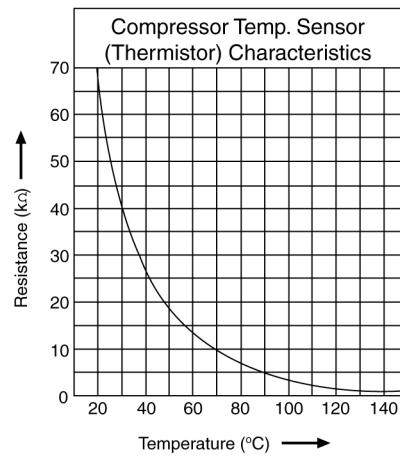
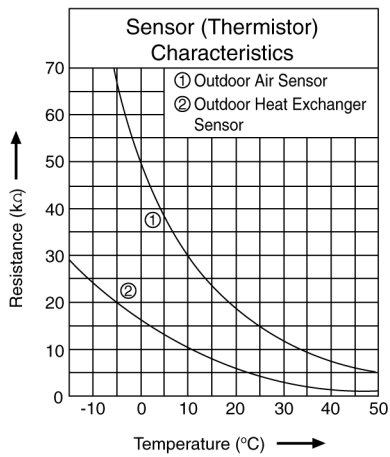

10 Printed Circuit Board

10.1. Indoor Unit

10.1.1. Main Printed Circuit Board

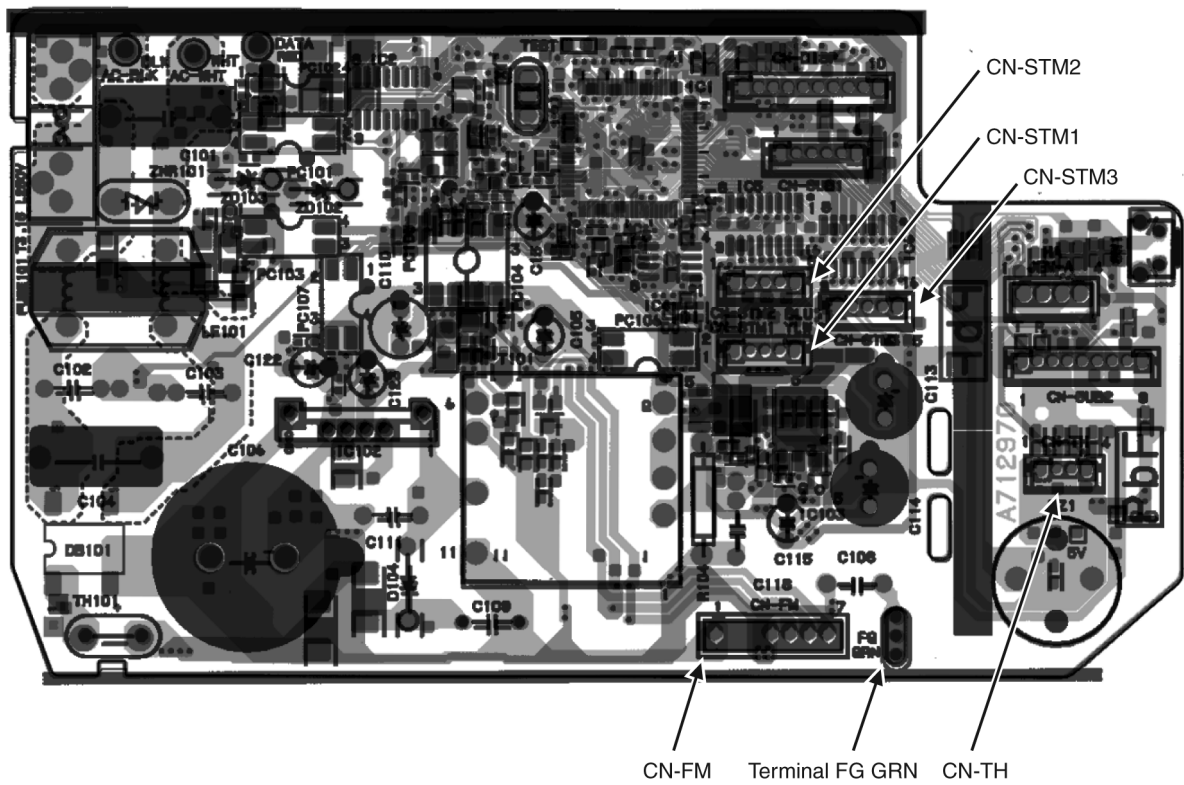

10.1.2. Indicator Panel

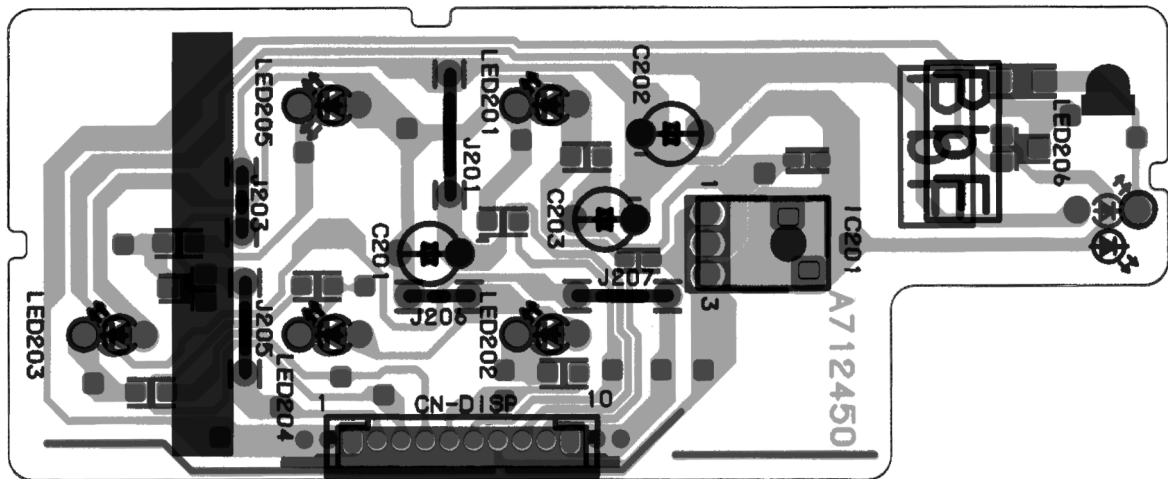

10.2. Outdoor Unit

10.2.1. Main Printed Circuit Board

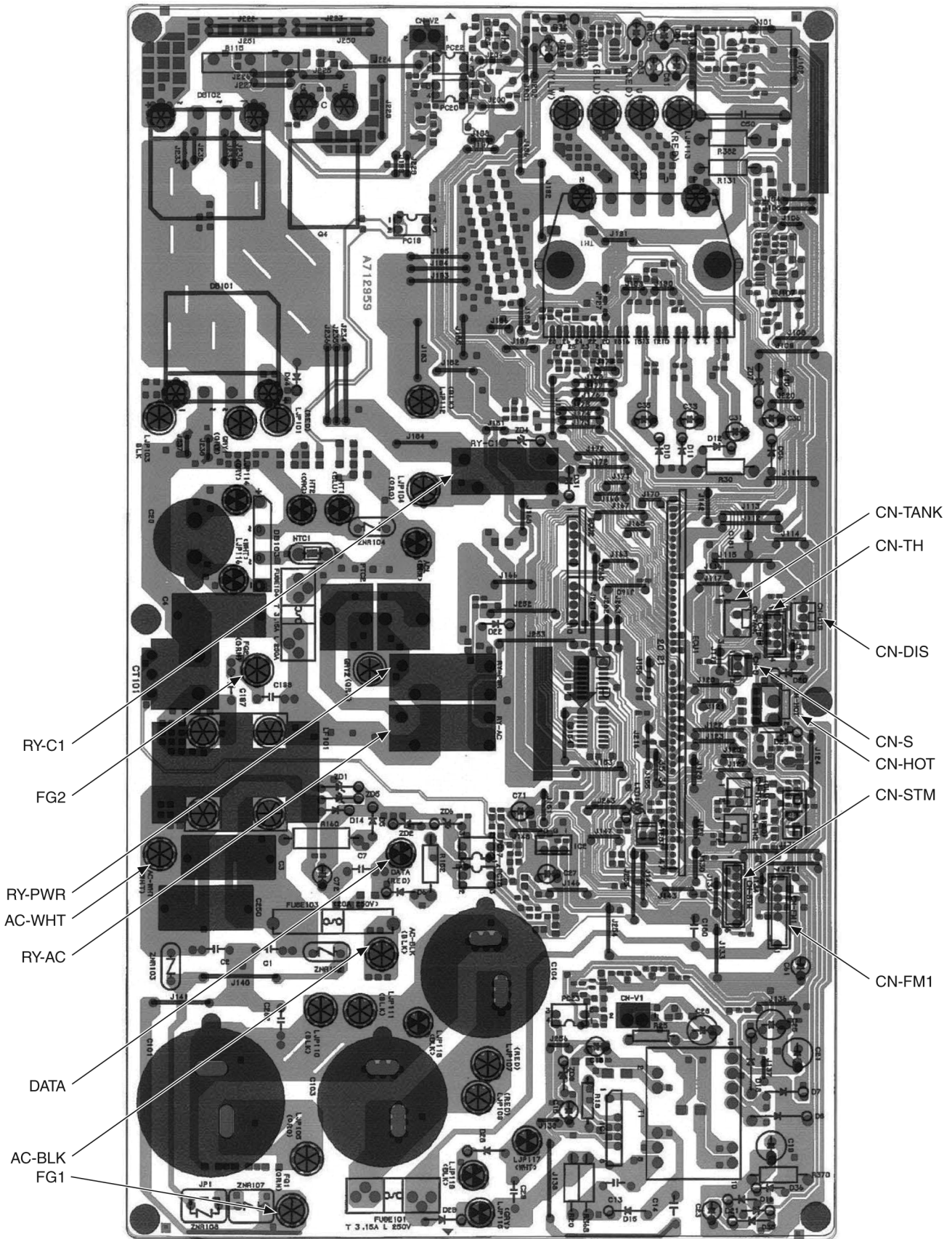

11 Installation Instruction

11.1. Select The Best Location

INDOOR UNIT

- There should not be any heat source or steam near the unit.
- There should not be any obstacles blocking the air circulation.
- A place where air circulation in the room is good.
- A place where drainage can be easily done.
- A place where noise prevention is taken into consideration.
- Do not install the unit near the door way.
- Ensure the spaces indicated by arrows from the wall, ceiling, fence or other obstacles.
- Recommended installation height for indoor unit shall be at least 2.5 m.

OUTDOOR UNIT

- If an awning is built over the unit to prevent direct sunlight or rain, be careful that heat radiation from the condenser is not obstructed.
- There should not be any animal or plant which could be affected by hot air discharged.
- Keep the spaces indicated by arrows from wall, ceiling, fence or other obstacles.
- Do not place any obstacles which may cause a short circuit of the discharged air.
- If piping length is over the rated length, additional refrigerant should be added as shown in the table.

Model	Horse Power (HP)	Piping size		Std. Length h(m)	Max. Elevation (m)	Min. Piping Length (m)	Max. Piping Length (m)	Additional Refrigerant (g/m)	Piping Length for add. gas (m)
		Gas	Li- quid						
HE9***	1.0HP	9.52 mm (3/8")	1/4"	5	5	3	15	20	7.5
HE12***	1.5HP	9.52 mm (3/8")	1/4"	5	5	3	15	20	7.5

Example: For HE9***

If the unit is installed at 10 m distance, the quantity of additional refrigerant should be 50 g $(10-7.5) \text{ m} \times 20 \text{ g/m} = 50 \text{ g}$

11.2. Indoor/Outdoor Unit Installation Diagram

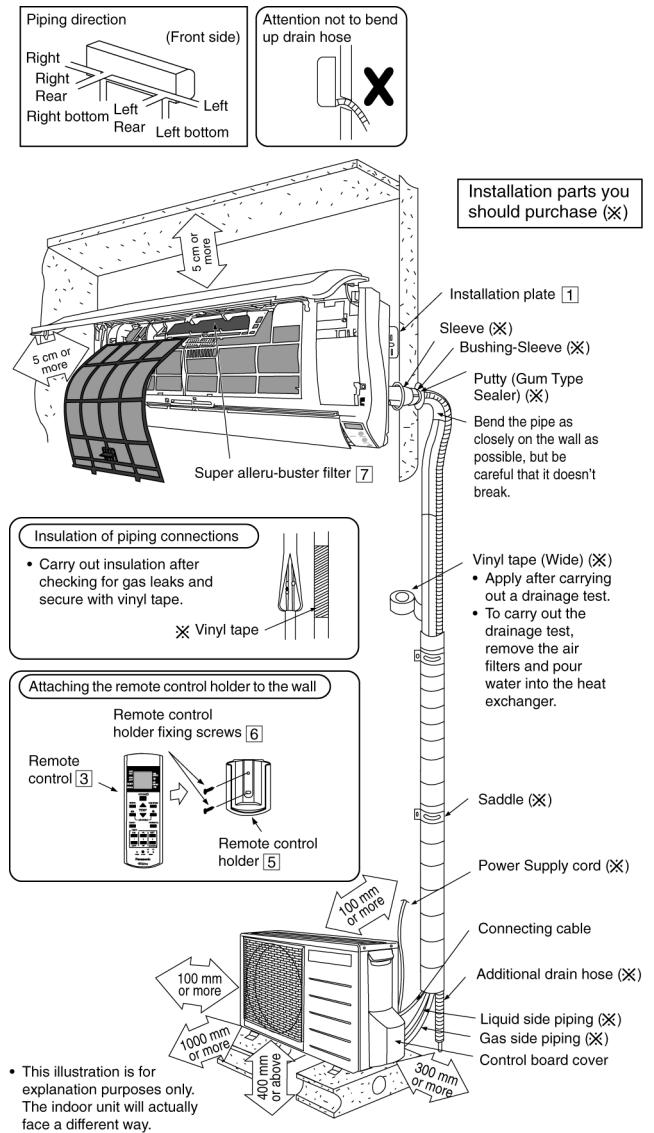

11.3. Indoor Unit

11.3.1. HOW TO FIX INSTALLATION PLATE

The mounting wall is strong and solid enough to prevent it from the vibration.

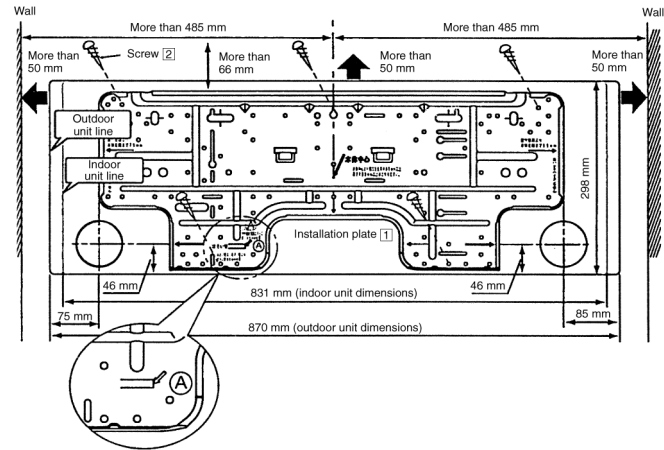

- A** : For left side piping, piping connection for liquid should be from this line.
 : For left side piping, piping connection for gas should be about 60 mm from this line.
 : For left side piping, piping connection cable should be about 750 mm from this line.

- Mount the installation plate on the wall with 5 screws or more.
 (If mounting the unit on the concrete wall, consider using anchor bolts.)
 - Line according to the arrows marked on the bottom left and right sides of the installation plate. The meeting point of the line extension is the centre of the hole.
- Drill the piping plate hole with $\varnothing 70$ mm hole-core drill.
 - The hole centre of the right pipe is at the crossing of the lines which extend vertically from the edge of the installation plate, and, horizontally, from the side arrow on the installation plate (see figure above.)
 - The hole centre of the left pipe is at the crossing of the lines which extend vertically from the downward arrow on the installation plate, and, horizontally, from the side arrow on the installation plate (see figure above.)
 - Drill the piping hole at either the right or the left and the hole should be slightly slanted to the outdoor side.

11.3.2. TO DRILL A HOLE IN THE WALL AND INSTALL A SLEEVE OF PIPING

- Insert the piping sleeve to the hole.
- Fix the bushing to the sleeve.
- Cut the sleeve until it extrudes about 15 mm from the wall.

CAUTION

When the wall is hollow, please be sure to use the sleeve for tube assembly to prevent dangers caused by mice biting the connecting cable.

- Finish by sealing the sleeve with putty or caulking compound at the final stage.

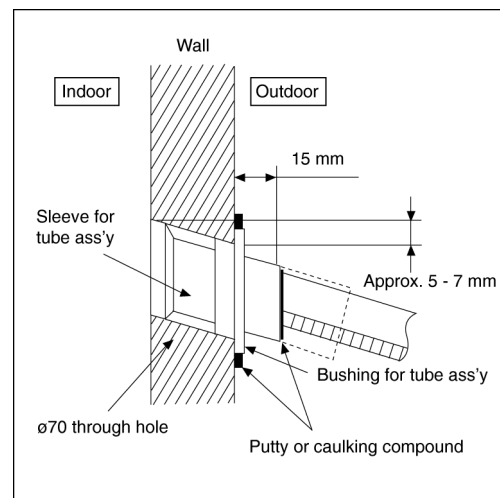

11.3.3. INDOOR UNIT INSTALLATION

1. For the right rear piping

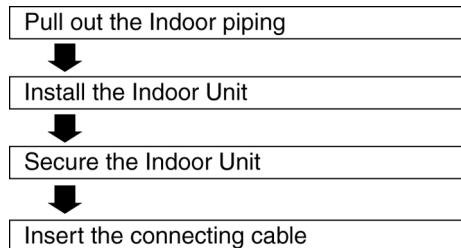

2. For the right and right bottom piping

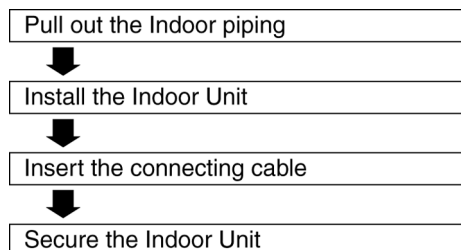

3. For the embedded piping

- Replace the drain hose
- Bend the embedded piping
 - Use a spring bender or equivalent to bend the piping so that the piping is not crushed.
- Install the Indoor Unit
- Cut and flare the embedded piping
 - When determining the dimensions of the piping, slide the unit all the way to the left on the installation plate.
 - Refer to the section "Cutting and flaring the piping".
- Pull the connecting cable into Indoor Unit
 - The inside and outside connecting cable can be connected without removing the front grille.
- Connect the piping
 - Please refer to "Connecting the piping" column in outdoor unit section. (Below steps are done after connecting the outdoor piping and gas-leakage confirmation.)
- Insulate and finish the piping
 - Please refer to "Piping and finishing" column of outdoor section and "Insulation of piping connections" column as mentioned in Indoor/Outdoor Unit Installation.
- Secure the Indoor Unit

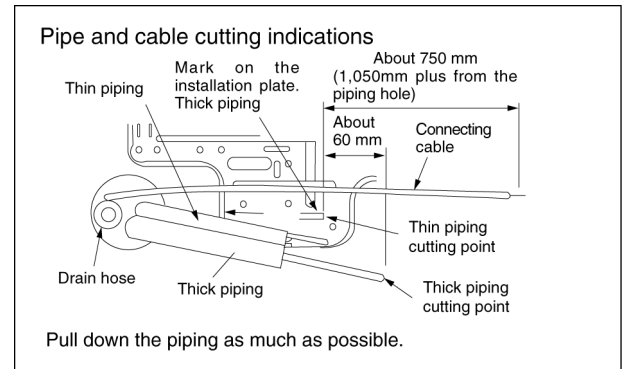
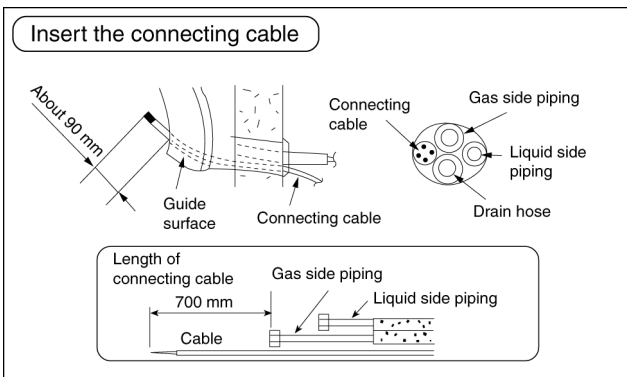
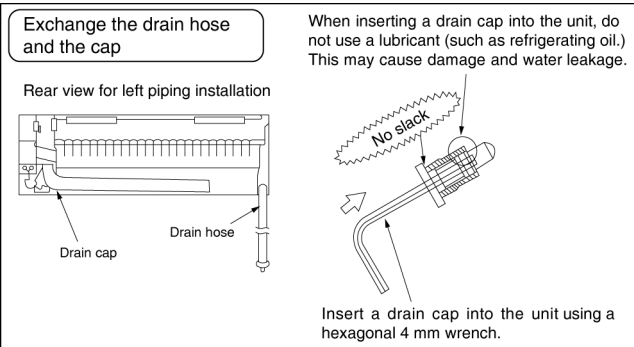
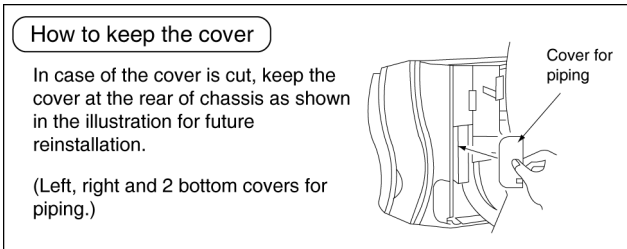
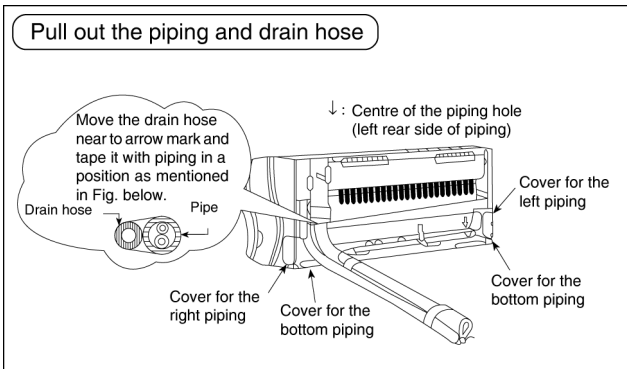
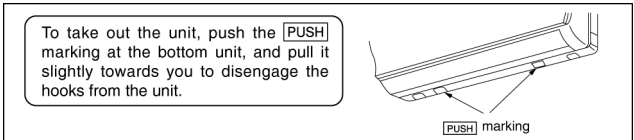
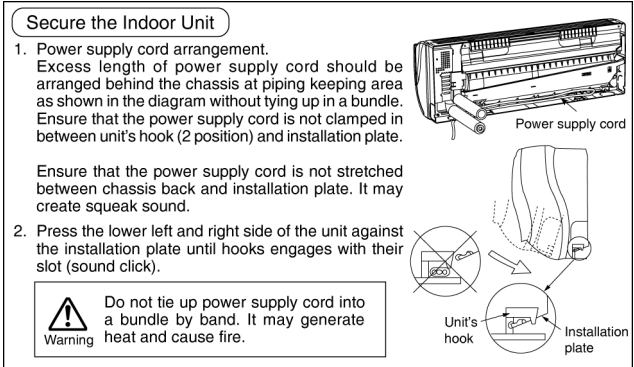
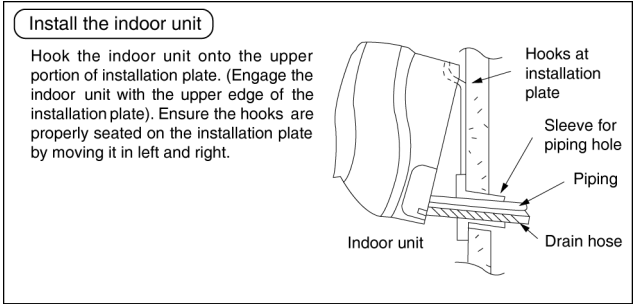

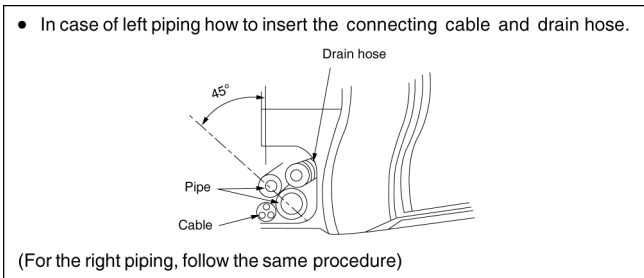
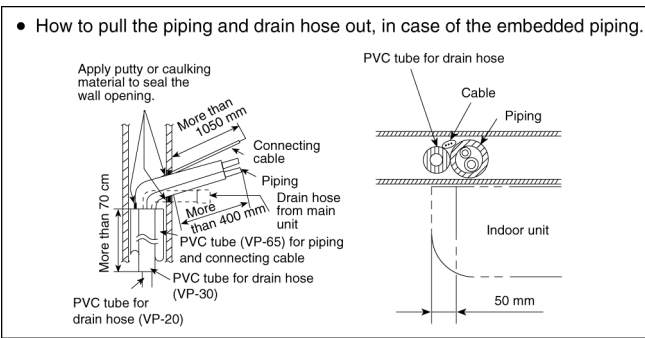
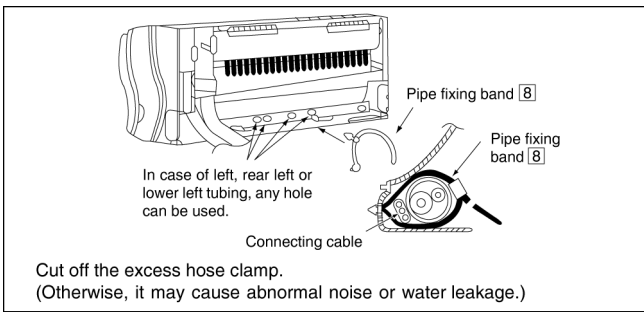

11.3.4. CONNECT THE CABLE TO THE INDOOR UNIT

1. The inside and outside connecting cable can be connected without removing the front grille.
2. **Connecting cable** between indoor unit and outdoor unit shall be approved polychloroprene sheathed 4 x 1.5 mm² flexible cord, type designation 245 IEC 57 or heavier cord.
3. Bind all the indoor and outdoor connecting cable with tape and route the connecting cable via the escapement.
4. Remove the tapes and connect the connecting cable between indoor unit and outdoor unit according to the diagram below.

Terminals on the indoor unit	1	2	3	
Colour of wires				
Terminals on the outdoor unit	1	2	3	

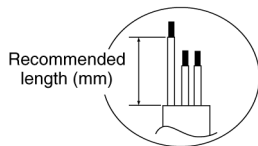

Recommended length (mm)	a	b	c	d
	35	35	35	80

This equipment must be properly earthed.

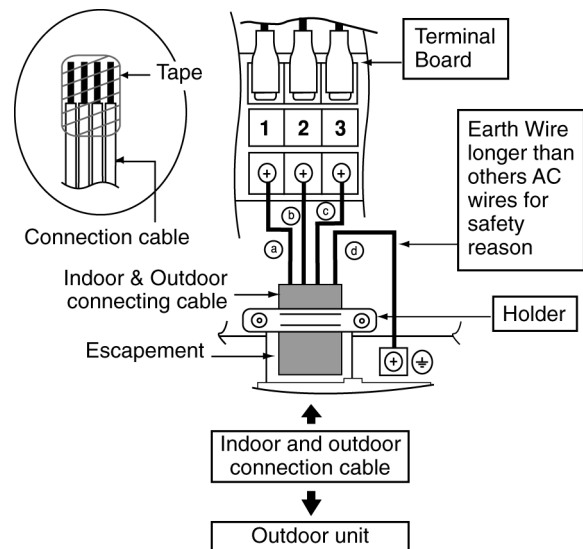

5. Secure the connecting cable onto the control board with the holder (clammer).
 - Ensure the colour of wires of outdoor unit and the terminal Nos. are the same to the indoor's respectively.
 - Earth wire shall be Yellow/Green (Y/G) in colour and longer than other AC wires for safety reason.

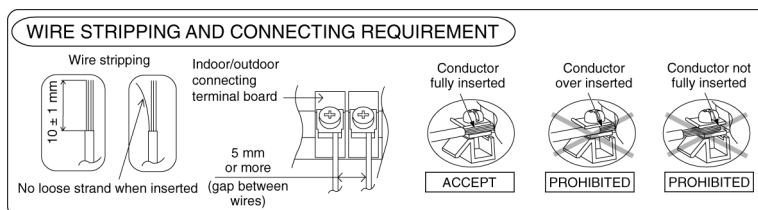

11.4. Outdoor Unit

11.4.1. INSTALL THE OUTDOOR UNIT

- After selecting the best location, start installation according to Indoor/Outdoor Unit Installation Diagram.
- 1. Install at least 40 cm above the ground. Do not install the unit on the floor.
- 2. Fix the unit on concrete or rigid frame firmly and horizontally by bolt (ø10 mm).
Install the outdoor unit in a level position and do not block the holes. Failure to do so may result in water leakage or accumulation.
- 3. When installing at roof, please consider strong wind and earthquake. Please fasten the installation stand firmly with bolt or nails.

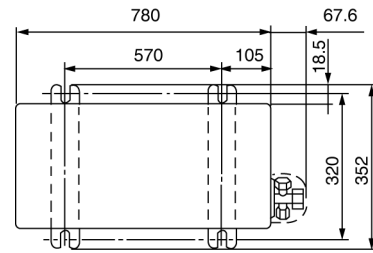

11.4.2. CONNECTING THE PIPING

Connecting The Piping To Indoor Unit

Please make flare after inserting flare nut (locate at joint portion of tube assembly) onto the copper pipe (in case of using long piping).

Connect the piping

- Align the center of piping and sufficiently tighten the flare nut with fingers.
- Further tighten the flare nut with torque wrench in specified torque as stated in the table.

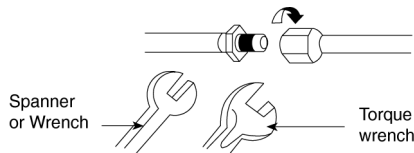

CAUTION	
Do not over tighten, over tightening cause gas leakage.	
Piping Size	Torque
6.35 mm (1/4")	[18 N•m (1.8 kgf.m)]
9.52 mm (3/8")	[42 N•m (4.3 kgf.m)]
12.7 mm (1/2")	[55 N•m (5.6 kgf.m)]
15.88 mm (5/8")	[65 N•m (6.6 kgf.m)]
19.05 mm (3/4")	[100 N•m (10.2 kgf.m)]

Connecting The Piping To Outdoor Unit

Decide piping length and then cut by using pipe cutter. Remove burrs from cut edge. Make flare after inserting the flare nut (locate at valve) onto the copper pipe.

Align center of piping to valves and then tighten with torque wrench to the specified torque as stated in the table.

CUTTING AND FLARING THE PIPING

1. Please cut using pipe cutter and then remove the burrs.
2. Remove the burrs by using reamer. If burrs is not removed, gas leakage may be caused.
Turn the piping end down to avoid the metal powder entering the pipe.
3. Please make flare after inserting the flare nut onto the copper pipes.

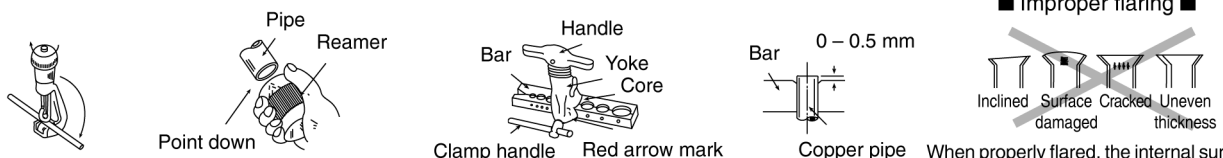

1. To cut

2. To remove burrs

3. To flare

When properly flared, the internal surface of the flare will evenly shine and be of even thickness. Since the flare part comes into contact with the connections, carefully check the flare finish.

11.4.3. EVACUATION OF THE EQUIPMENT

WHEN INSTALLING AN AIR CONDITIONER, BE SURE TO EVACUATE THE AIR INSIDE THE INDOOR UNIT AND PIPES in the following procedure.

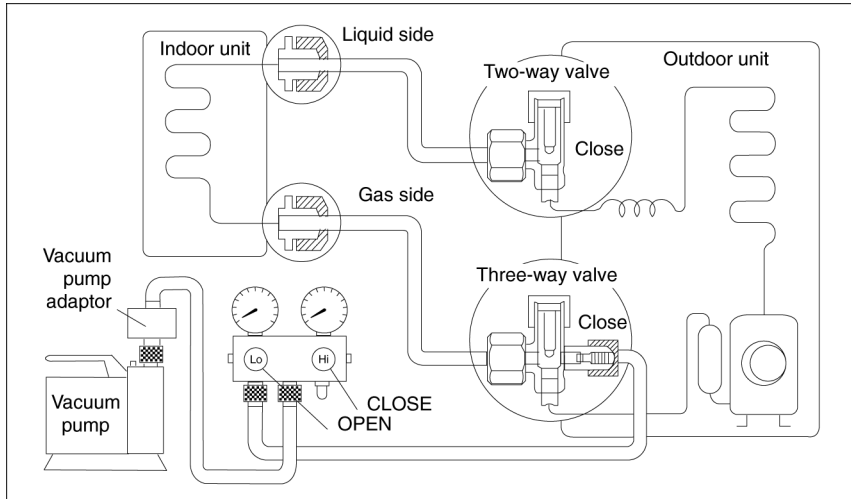

1. Connect a quick-coupling charging hose to the Low and High sides of a charging set and to the service port of the 3-way valve.
 - Be sure to connect the end of the charging hose with quick coupling to the service port.
2. Connect the centre hose of the charging set to a vacuum pump with check valve, or to a vacuum pump with suitable adaptor.
3. Turn on the power switch of the vacuum pump and make sure that the needle in the gauge moves from 0 cmHg (0 MPa) to -76 cmHg (-0,1 MPa), then evacuate the air for about 15 minutes.
4. Close the Low and High side valves of the charging set and turn off the vacuum pump. Make sure that the needle of the gauge doesn't move after about 5 minutes.
Note: FOLLOW THIS PROCEDURE CAREFULLY IN ORDER TO AVOID REFRIGERANT GAS LEAKAGE.
5. Disconnect the charging hose from the vacuum pump and from the service port of the 3-way valve.
6. Tighten the service port caps of the 3-way valve at a torque of 18 N•m with a torque wrench.
7. Remove the valve caps of both of the 2-way valve and 3-way valve. Position both of the valves to "OPEN" using a hexagonal wrench (4 mm).
8. Mount valve caps onto the 2-way valve and the 3-way valve.
 - Be sure to check for gas leakage.

CAUTION

- If gauge needle does not move from 0 cmHg (0 MPa) to -76 cmHg (-0.1 MPa), in step ③ above take the following measure:
 - If the leak stops when the piping connections are tightened further, continue working from step ③.
 - If the leak does not stop when the connections are retightened, repair the location of leak.
 - Do not release refrigerant during piping work for installation and reinstallation.
 - Take care of the liquid refrigerant, it may cause frostbite.

11.4.4. CONNECT THE CABLE TO THE OUTDOOR UNIT

1. Remove the control board cover from the unit by loosening the screw.
2. Cable connection to the power supply through Isolating Devices (Disconnecting means).
 - Connect approved type polychloroprene sheathed **power supply cord** 3 x 1.5 mm² (1.0 ~ 1.5HP) type designation 245 IEC 57 or heavier cord to the terminal board, and connect the others end of the cord to Isolating Devices (Disconnecting means).
3. **Connecting cable** between indoor unit and outdoor unit shall be approved polychloroprene sheathed 4 x 1.5 mm² flexible cord, type designation 245 IEC 57 or heavier cord.
4. Connect the power supply cord and connecting cable between indoor unit and outdoor unit according to the diagram below.

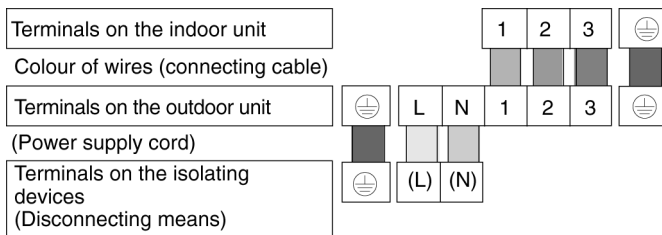
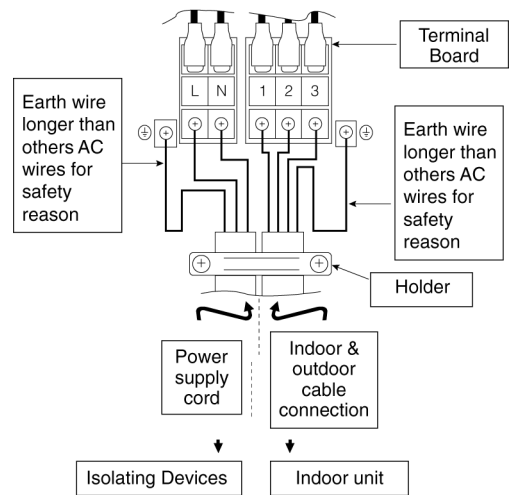

5. Secure the power supply cord and connecting cable onto the control board with the holder.
6. Attach the control board cover back to the original position with screw.
7. For wire stripping and connection requirement, refer to instruction ⑤ of indoor unit.

- ⚡ This equipment must be properly earthed.
 - Note: Isolating Devices (Disconnecting means) should have minimum 3.0 mm contact gap.
 - Earth wire shall be Yellow/Green (Y/G) in colour and longer than other AC wires for safety reason.

11.4.5. Pipe Insulation

1. Please carry out insulation at pipe connection portion as mentioned in Indoor/Outdoor Unit Installation Diagram. Please wrap the insulated piping end to prevent water from going inside the piping.
2. If drain hose or connecting piping is in the room (where dew may form), please increase the insulation by using POLY-E FOAM with thickness 6 mm or above.

12 Operation and Control

12.1. Basic Function

Inverter control, which is equipped with a microcomputer, determines the most suitable operating mode as time passes, automatically adjusting output power for maximum comfort. In order to achieve the suitable operating mode, the microcomputer maintains the set temperature by measuring the temperature of the environment and performing temperature shifting. The compressor at the outdoor unit is operating following the frequency instructed by the microcomputer at the indoor unit, judging the condition according to the internal setting temperature and intake air temperature.

12.1.1. Internal Setting Temperature

Once the operation starts, the remote control setting temperature will be taken as the base value for temperature shifting processes. These shifting processes depend on the air conditioner settings and the operation environment. The final shifted value will be used as the internal setting temperature and is updated continuously whenever the electrical power is supplied to the unit.

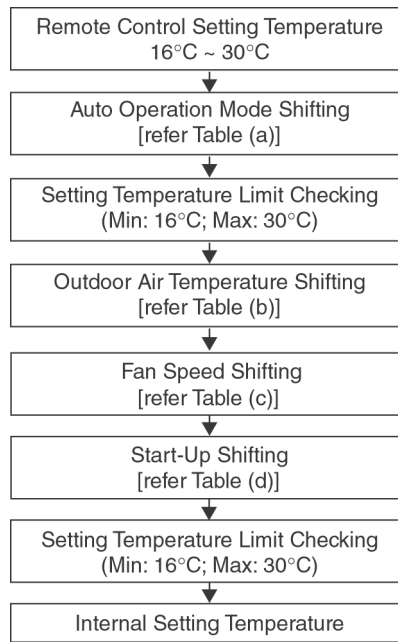

12.1.2. Cooling Operation

12.1.2.1. Thermostat control

- Compressor is OFF when Intake Air Temperature - Internal Setting Temperature $< -1.5^{\circ}\text{C}$.
- Compressor is ON after waiting for 3 minutes, if the Intake Air Temperature - Internal Setting Temperature $>$ Compressor OFF point.

12.1.3. Heating Operation

12.1.3.1. Thermostat control

- Compressor is OFF when Intake Air Temperature - Internal Setting Temperature $> +2.0^{\circ}\text{C}$.
- Compressor is ON after waiting for 3 minutes, if the Intake Air Temperature - Internal Setting Temperature $<$ Compressor OFF point.

12.1.4. Automatic Operation

- This mode can be set using remote control and the operation is decided by remote control setting temperature, remote control operation mode, indoor intake air temperature and outdoor air temperature.
- During operation mode judgment, indoor fan motor (with speed of Lo-) and outdoor fan motor are running for 30 seconds to detect the indoor intake and outdoor air temperature. The operation mode is decided based on below chart.

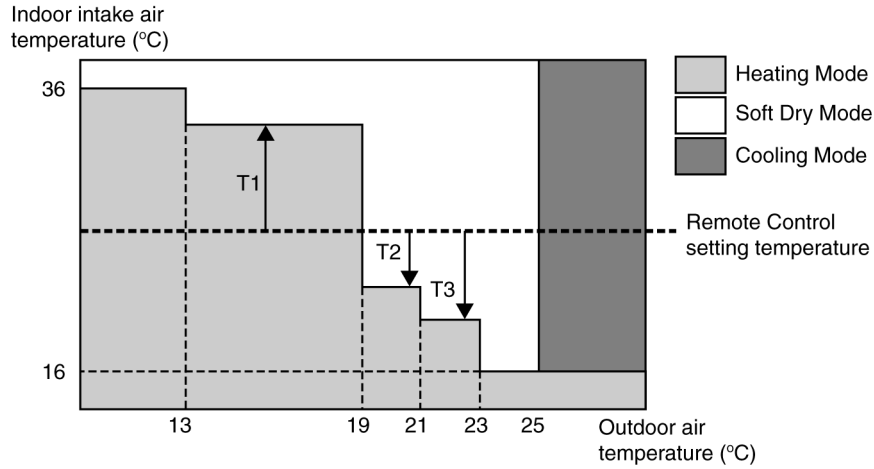

Every 30 minutes, the indoor and outdoor temperature is judged. Based on remote control setting temperature, the value of T1 will increase up to 10°C, T2 will decrease by 3°C and T3 will decrease up to 8°C. The Auto Operation Mode shifting will take place whenever operation mode changed from Cooling/Soft Dry to Heating or vice versa.

12.1.5. Fan Operation

- Fan Operation is used to circulate air in a room.
- During operation, indoor fan run continuously but outdoor fan and compressor stop.
- Temperature setting is not applicable.

12.2. Indoor Fan Motor Operation

A. Basic Rotation Speed (rpm)

i. Manual Fan Speed

[Cooling, Dry]

- Fan speed is determined according to remote control setting.

Remote Control	O	O	O	O	O
Tab	Hi	Me+	Me	Me-	Lo

[Heating]

- Fan speed is determined according to remote control setting and outdoor heat exchanger temperature.

Remote Control	O	O	O	O	O
Tab	SHi	Me+	Me	Me-	Lo

ii. Auto Fan Speed

[Cooling, Dry]

- According to room temperature and setting temperature, indoor fan speed is determined automatically.
- The indoor fan will operate according to pattern below.

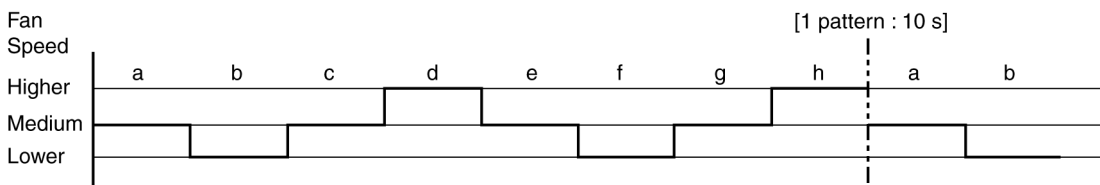

[Heating]

- According to indoor pipe temperature, automatic heating fan speed is determined as follows.

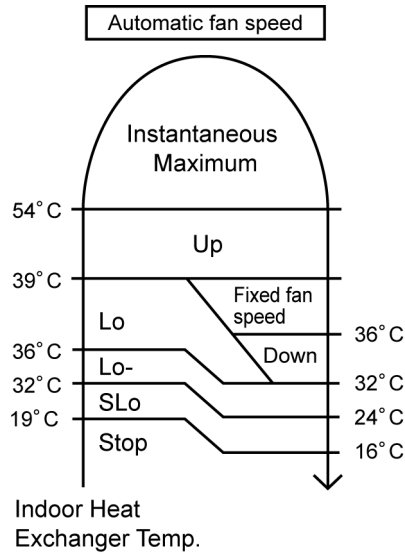

B. Feedback control

- Immediately after the fan motor started, feedback control is performed once every second.
- During fan motor on, if fan motor feedback ≥ 2550 rpm or < 50 rpm continue for 10 seconds, then fan motor error counter increase, fan motor is then stop and restart. If the fan motor counter becomes 7 times, then H19 - fan motor error is detected. Operation stops and cannot on back.

12.3. Outdoor Fan Motor Operation

Outdoor fan motor is operated with one fan speed only. It starts when compressor starts operation and it stops 30 seconds after compressor stops operation.

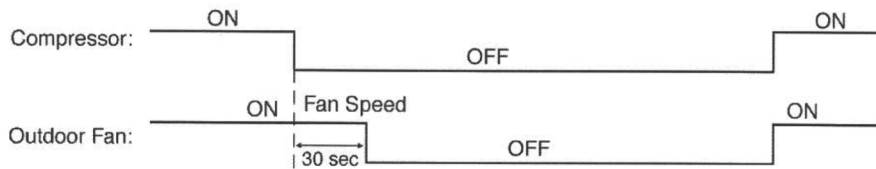

12.4. Airflow Direction Control

12.4.1. Horizontal and Vertical Directions

Vertical louver is controlled by remote control: the Vertical Airflow Direction button on the remote controller and by each operation mode, as shown in the table below.

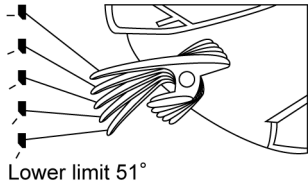
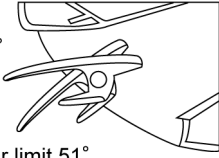
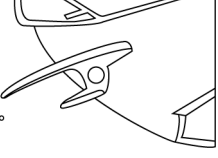
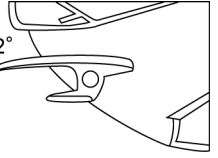
Cooling Operation Mode		
Manual Operation	Vertical Automatic Operation	Powerful-ON
 <p>Upper limit 12°</p> <p>Lower limit 51°</p> <ul style="list-style-type: none"> • Five-level setting is possible with the remote controller. 	<p>Swing</p>  <p>Upper limit 12°</p> <p>Lower limit 51°</p> <ul style="list-style-type: none"> • The louver swings between the upper limit and the lower limit. 	 <p>26°</p> <ul style="list-style-type: none"> • After Powerful is turned on, the louver is fixed at 26° for 5 minutes or until the Neural Control is stabilized.  <p>12°</p> <ul style="list-style-type: none"> • After the Neural Control is stabilized, the louver is fixed at 12°.

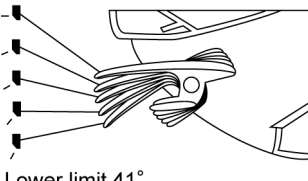
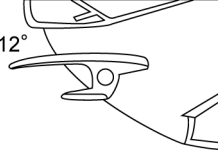
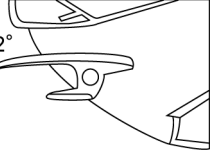
Dry Operation Mode		
Manual Operation	Vertical Automatic Operation	Power-ON (Automatic Operation)
 <p>Upper limit 12°</p> <p>Lower limit 41°</p> <ul style="list-style-type: none"> • Five-level setting is possible with the remote controller. 	 <p>12°</p> <ul style="list-style-type: none"> • The louver is fixed at 12°. 	 <p>12°</p> <ul style="list-style-type: none"> • The louver is fixed at 12°.

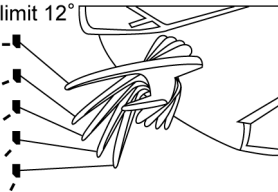
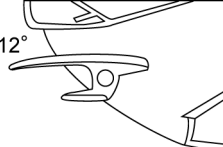
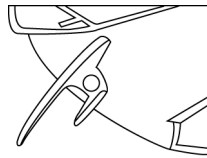
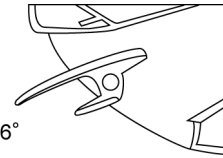
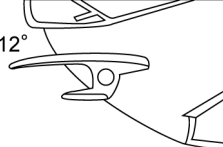
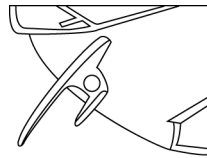
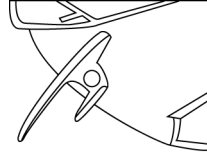
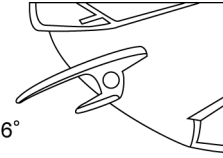
Heating Operation Mode		
Manual Operation	Vertical Automatic Operation	Power-ON
<p>Upper limit 12°</p>  <p>Lower limit 66°</p> <p>• Five-level setting is possible with the remote controller.</p>	<p>1. When heat exchanger temperature is less than 32°C.</p>  <p>12°</p> <p>2. When heat exchanger temperature is between 32°C and 56°C.</p>  <p>66° (57°)</p> <p>3. When heat exchanger temperature is 56°C or more.</p>  <p>26°</p>	<p>1. When heat exchanger temperature is less than 32°C.</p>  <p>12°</p> <p>2. Quick Heating Operation</p>  <p>61° (52°)</p> <p>3. Warm Heating Operation</p>  <p>66° (57°)</p> <p>4. When heat exchanger temperature is 56°C or more.</p>  <p>26°</p>

- The vertical louver is closed when the unit is turned off with the remote controller. (Stop position)
- The vertical louver is fully opened and move to the setting position when the unit is turned on with the remote controller.
- The vertical louver remains at open position when the unit is turned off during operation.
- The values in the parentheses () are for the models: CS-HE12LKE.

12.4.2. Horizontal Airflow Direction Control

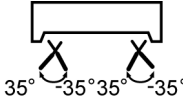
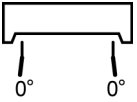
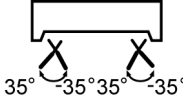
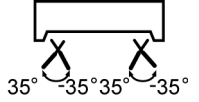
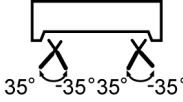
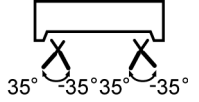
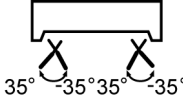
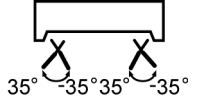
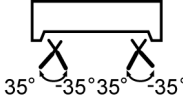
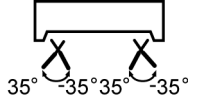
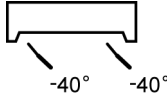
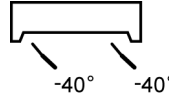
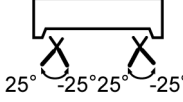
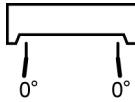
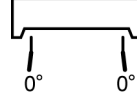
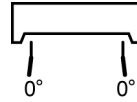
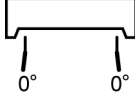
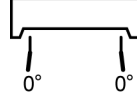
Operation Mode		Horizontal Automatic Operation	Operation for 5 min. after Powerful-ON or the Neural Control is stabilized.
Cooling		 <p>35° -35° 35° -35°</p> <ul style="list-style-type: none"> The louver horizontally swings at a fixed cycle. 	 <p>0° 0°</p>
		 <p>35° -35° 35° -35°</p> <ul style="list-style-type: none"> The louver horizontally swings at a fixed cycle. 	 <p>35° -35° 35° -35°</p> <ul style="list-style-type: none"> The louver horizontally swings at a fixed cycle.
Dry		 <p>35° -35° 35° -35°</p> <ul style="list-style-type: none"> The louver horizontally swings at a fixed cycle. 	 <p>35° -35° 35° -35°</p> <ul style="list-style-type: none"> The louver horizontally swings at a fixed cycle.
		 <p>35° -35° 35° -35°</p> <ul style="list-style-type: none"> The louver horizontally swings at a fixed cycle. 	 <p>35° -35° 35° -35°</p> <ul style="list-style-type: none"> The louver horizontally swings at a fixed cycle.
		 <p>35° -35° 35° -35°</p> <ul style="list-style-type: none"> The louver horizontally swings at a fixed cycle. 	 <p>35° -35° 35° -35°</p> <ul style="list-style-type: none"> The louver horizontally swings at a fixed cycle.
Heating	When heat exchanger temperature is below 32°C.	 <p>-40° -40°</p>	 <p>-40° -40°</p>
	When heat exchanger is between 32°C (, incl.) and 56°C (, excl.)	<p>When the Neural Control is stabilized.</p>  <p>25° -25° 25° -25°</p> <ul style="list-style-type: none"> The louver horizontally swings at a fixed cycle. <p>When the Neural Control is not stabilized.</p>  <p>0° 0°</p>	<p>In Quick Warm Operation</p>  <p>0° 0°</p> <p>In Warm Heating Operation</p>  <p>0° 0°</p>
	When heat exchanger temperature is 56°C or more.	 <p>0° 0°</p>	 <p>0° 0°</p>

12.5. Quiet operation (Cooling Mode/Cooling area of Dry Mode)

A. Purpose

To provide quiet cooling operation compare to normal operation.

B. Control condition

a. Quiet operation start condition

- When "quiet" button at remote control is pressed.
Quiet LED illuminates.

b. Quiet operation stop condition

- When one of the following conditions is satisfied, quiet operation stops:
 - Powerful button is pressed.
 - Stop by OFF/ON switch.
 - Timer "off" activates.
 - Quiet button is pressed again.
- When quiet operation is stopped, operation is shifted to normal operation with previous setting.
- When fan speed is changed, quiet operation is shifted to quiet operation of the new fan speed.
- When operation mode is changed, quiet operation is shifted to quiet operation of the new mode.
- During quiet operation, if timer "on" activates, quiet operation maintains.
- After off, when on back, quiet operation is not memorised.

C. Control contents

1. Auto fan speed is changed from normal setting to quiet setting of respective fan speed.
This is to reduce sound of Hi, Me, Lo for 3dB.
2. Manual fan speed for quiet operation is -1 step from setting fan speed.

12.6. Quiet operation (Heating)

A. Purpose

To provide quiet heating operation compare to normal operation.

B. Control condition

- a. Quiet operation start condition
 - When “quiet” button at remote control is pressed.
Quiet LED illuminates.
- b. Quiet operation stop condition
 1. When one of the following conditions is satisfied, quiet operation stops:
 - a. Powerful button is pressed.
 - b. Stop by OFF/ON switch.
 - c. Timer “off” activates.
 - d. Quiet button is pressed again.
 2. When quiet operation is stopped, operation is shifted to normal operation with previous setting.
 3. When fan speed is changed, quiet operation is shifted to quiet operation of the new fan speed.
 4. When operation mode is changed, quiet operation is shifted to quiet operation of the new mode, expected fan only mode.
 5. During quiet operation, if timer “on” activates, quiet operation maintains.
 6. After off, when on back, quiet operation is not memorised.

C. Control contents

- a. Fan speed auto
 1. Indoor FM RPM depends on pipe temp sensor of indoor heat exchanger. Auto fan speed is changed from normal setting to quiet setting of respective fan speed. This is to reduce sound of Hi, Me, Lo for 3dB.
- b. Fan speed manual
 1. Manual fan speed for quiet operation is -1 step from setting fan speed.

12.7. Powerful Operation

When the Powerful Mode is selected, the unit always forced to operate in Powerful Initial Mode for 5 minutes. Thereafter, the temperature different (intake air temperature — remote control setting temperature) is detected periodically to judge the operation zone and suitable control.

After powerful operation activated, it could be turned off when:

- Powerful button is pressed again
- Fan speed button is pressed
- Quiet button is pressed

12.8. Timer Control

12.8.1. ON Timer Control

- ON timer can be set using remote control, the unit with timer set will start operate earlier than the setting time. This is to provide a comfortable environment when reaching the set ON time.
- 60 minutes before the set time, indoor (at fan speed of Lo-) and outdoor fan motor start operate for 30 seconds to determine the indoor intake air temperature and outdoor air temperature in order to judge the operation starting time.
- From the judgment, the decided operation will start operate earlier than the set time as shown below.

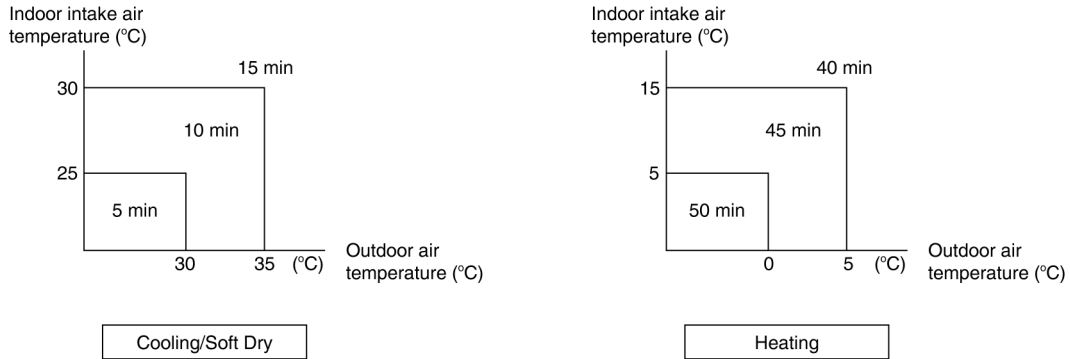

12.8.2. OFF Timer Control

OFF timer can be set using remote control, the unit with timer set will stop operate at set time.

12.9. Auto Restart Control

1. When the power supply is cut off during the operation of air conditioner, the compressor will re-operate within three to four minutes (there are 10 patterns between 2 minutes 58 seconds and 3 minutes 52 seconds to be selected randomly) after power supply resumes.
2. This type of control is not applicable during ON/OFF Timer setting.

12.10. Indication Panel

LED	POWER	TIMER	QUIET	POWERFUL	+8/10°C HEAT
Color	Green	Orange	Orange	Orange	Green
Light ON	Operation ON	Quiet Setting ON	Quiet Mode ON	Powerful Mode ON	+8/10°C HEAT Mode ON
Light OFF	Operation OFF	Quiet Setting OFF	Quiet Mode OFF	Powerful Mode OFF	+8/10°C HEAT Mode OFF

Note:

- If POWER LED is blinking, the possible operations of the unit are Hot Start, during Deice operation, operation mode judgement, or ON timer sampling.
- If Timer LED is blinking, there is an abnormality operation occurs.

12.11. +8/10°C Heat Operation

- +8/10°C Heat operation provides heating at low setting temperature in unoccupied houses during winter for the purpose of protecting equipments or housing appliances which may be destroyed by the extreme cold weather.
- This operation can be ON by pressing the +8/10°C heat button on the remote control.
- Two temperature settings are available, which are;
 - 8°C (Pressing TEMP down button at the remote control)
 - 10°C (Pressing TEMP up button at the remote control)
- During the operation of this mode;
 - The indoor fan speed will remain at Hi fan tap all the time included deice process.
 - Powerful operation, Quiet operation and Fan Speed selection are disabled.
 - Cold draft prevention control is disabled.
- Control condition;

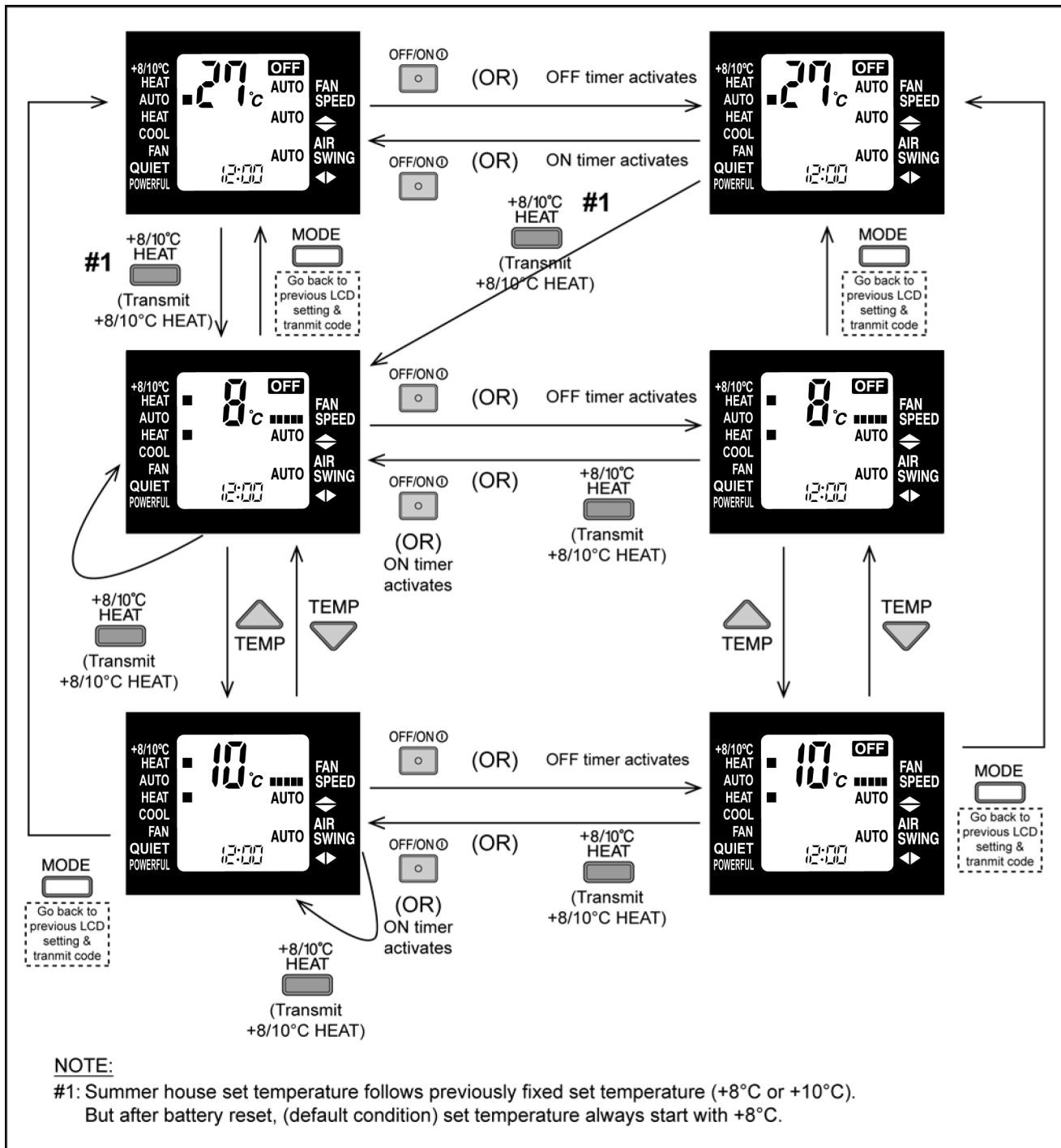

• Caution!

If the indoor temperature constantly is less than 0°C (Door, windows not close properly), the error code F11 may occur. This is because in open area, the indoor sensor will misjudge operation condition and will give error code.

13 Protection Control

13.1. Protection Control For All Operations

13.1.1. Time Delay Safety Control

1. The compressor will not start for 3 minutes after stop of the operation.
2. This control is not applicable if the power supply is cut off and on again or after 4-way valve deices condition.

13.1.2. 30 Seconds Forced Operation

1. Once compressor starts the operation, it will not stop its operation for 30 seconds.
2. However, it can be stopped with the remote control or the Auto Switch on the indoor unit.

13.1.3. Total Running Current Control

1. When the outdoor unit total running current (AC) exceeds X value, the frequency instructed for compressor operation will be decreased.
2. If the running current does not exceed X value for 5 seconds, the frequency instructed will be increased.
3. However, if total outdoor unit running current exceeds Y value, compressor will be stopped immediately for 3 minutes.

Model	HE9LK		HE12LK	
	X (A)	Y (A)	X (A)	Y (A)
Cooling/Soft Dry (A)	3.56	16.99	5.54	16.99
Cooling/Soft Dry (B)	3.11	16.99	5.10	16.99
Cooling/Soft Dry (C)	3.56	16.99	5.54	16.99
Heating	7.33	16.99	9.56	16.99

4. The first 30 minutes of cooling operation, (A) will be applied.

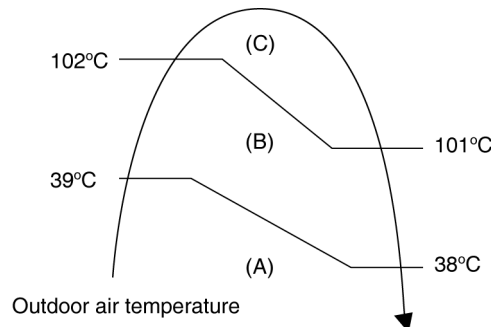

13.1.4. IPM (Power transistor) Prevention Control

A. Overheating Prevention Control

1. When the IPM temperature rises to 100°C, compressor operation will stop immediately.
2. Compressor operation restarts after 3 minutes the temperature decreases to 95°C.

B. DC Peak Current Control

1. When electric current to IPM exceeds set value of 20.2 A, the compressor will stop operate. Then, operation will restart after 3 minutes.
2. If the set value is exceeded again more than 30 seconds after the compressor starts, the operation will restart after 1 minute.
3. If the set value exceeded again within 30 seconds after the compressor starts, the operation will restart after 2 minutes. If this condition repeats continuously for 7 times, all indoor and outdoor relays will be cut off.

13.1.5. Compressor Overheating Prevention Control

Instructed frequency for compressor operation will be regulated by compressor discharge temperature. The changes of frequency are as below figure.

If compressor discharge temperature exceeds 110°C, compressor will stop, occurs 4 times per 20 minutes, timer LED will be blinking. ("F97" is to be confirmed.)

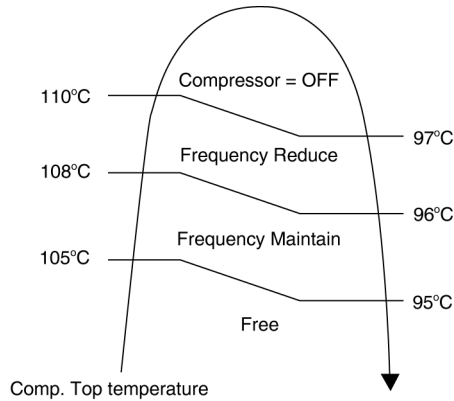

13.1.6. Low Pressure Prevention Control (Gas Leakage Detection)

a. Control start conditions

- For 5 minutes, the compressor continuously operates and outdoor total current is between 0.6A and 1.15A.
- During Cooling and Soft Dry operations:
Indoor suction temperature - indoor piping temperature is below 4°C.
- During Heating operations :
Indoor piping temperature - indoor suction is under 5°C.

b. Control contents

- Compressor stops (and restart after 3 minutes).
- If the conditions above happen 2 times within 20 minutes, the unit will:
 - Stop operation
 - Timer LED blinks and "F91" indicated.

13.1.7. Low Frequency Protection Control 1

When the compressor operates at frequency lower than 25 Hz continued for 240 minutes, the operation frequency will be changed to 24 Hz for 2 minutes.

13.1.8. Low Frequency Protection Control 2

When all the below conditions comply, the compressor frequency will change to lower frequency.

Temperature, T, for:	Cooling/Soft Dry	Heating
Indoor intake air (°C)	$T < 14$ or $T \geq 30$	$T < 14$ or $T \geq 28$
Outdoor air (°C)	$T < 13$ or $T \geq 38$	$T < 4$ or $T \geq 24$
Indoor heat exchanger (°C)	$T < 30$	$T \geq 0$

13.2. Protection Control For Cooling

13.2.1. Outdoor Air Temperature Control

- The compressor operating frequency is regulated in accordance to the outdoor air temperature as shown in the diagram below.
- This control will begin 1 minute after the compressor starts.

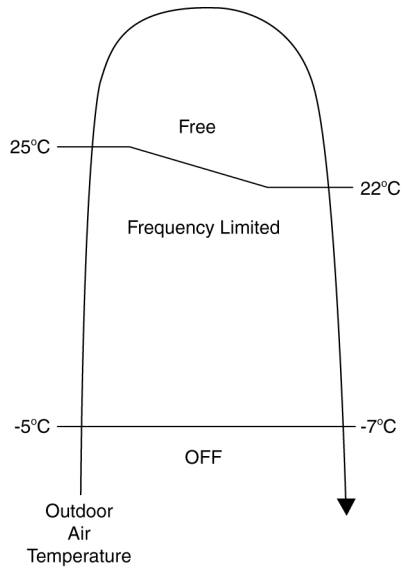

13.2.2. Cooling Overload Control

- Detects the Outdoor pipe temperature and carry out below restriction/limitation (Limit the compressor Operation frequency)
- The compressor stops if outdoor pipe temperature exceeds 63°C
- If the compressor stops 4 times in 20 minutes, Timer LED blinking (F95: outdoor high pressure rise protection)

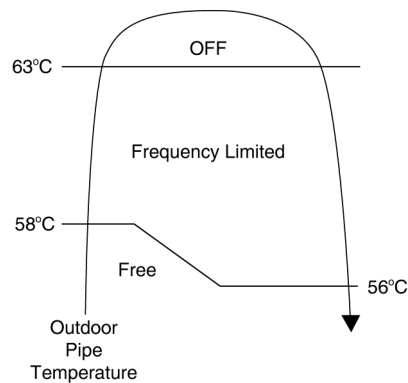

13.2.3. Freeze Prevention Control

1. When indoor heat exchanger temperature is lower than 0°C continuously for 6 minutes, compressor will stop operating.
2. Compressor will resume its operation 3 minutes after the indoor heat exchanger is higher than 13°C.
3. At the same time, indoor fan speed will be higher than during its normal operation.
4. If indoor heat exchanger temperature is higher than 13°C for 5 minutes, the fan speed will return to its normal operation.

13.3. Protection Control For Heating Operation

13.3.1. Intake Air Temperature Control

Compressor will operate at Max frequency if below condition occur:

1. When the indoor intake air temperature is 30°C or above.

13.3.2. Outdoor Air Temperature Control

- The maximum current value is regulated when the outdoor air temperature rises above 14°C in order to avoid compressor overloading.

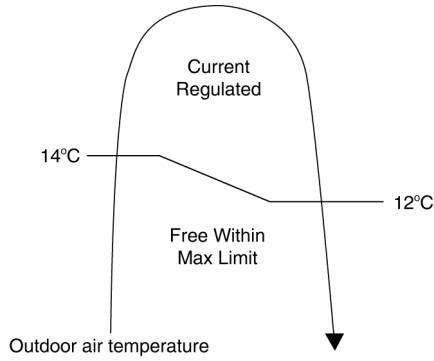

13.3.3. Overload Protection Control

- The compressor operating frequency is regulated in accordance to indoor heat exchanger temperature as shown in below.
- If the heat exchanger temperature exceeds 60°C, compressor will stopped.

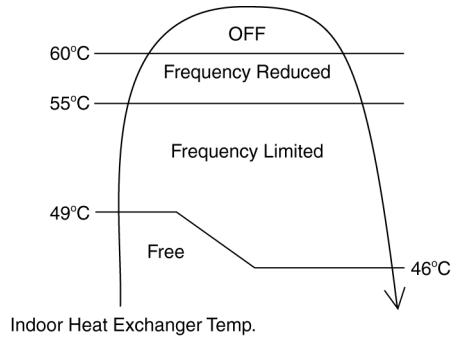

14 Servicing Mode

14.1. Auto OFF/ON Button

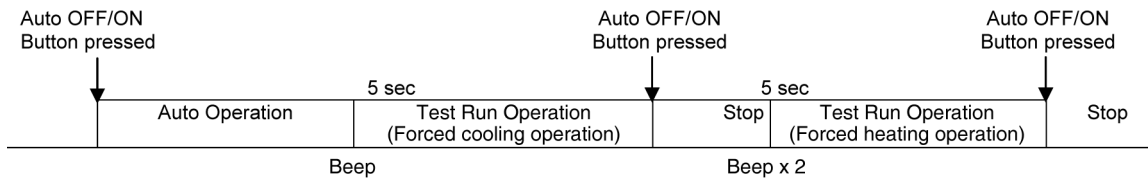

1. AUTO OPERATION MODE

The Auto operation will be activated immediately once the Auto OFF/ON button is pressed. This operation can be used to operate air conditioner with limited function if remote control is misplaced or malfunction.

2. TEST RUN OPERATION (FOR PUMP DOWN/SERVICING PURPOSE)

The Test Run operation will be activated if the Auto OFF/ON button is pressed continuously for more than 5 seconds. A “beep” sound will occur at the fifth seconds, in order to identify the starting of Test Run operation (Forced cooling operation). Within 5 minutes after Forced cooling operation start, the Auto OFF/ON button is pressed for more than 5 seconds. A 2 “beep” sounds will occur at the fifth seconds, in order to identify the starting of Forced heating operation.

The Auto OFF/ON button may be used together with remote control to set / change the advance setting of air conditioner operation.

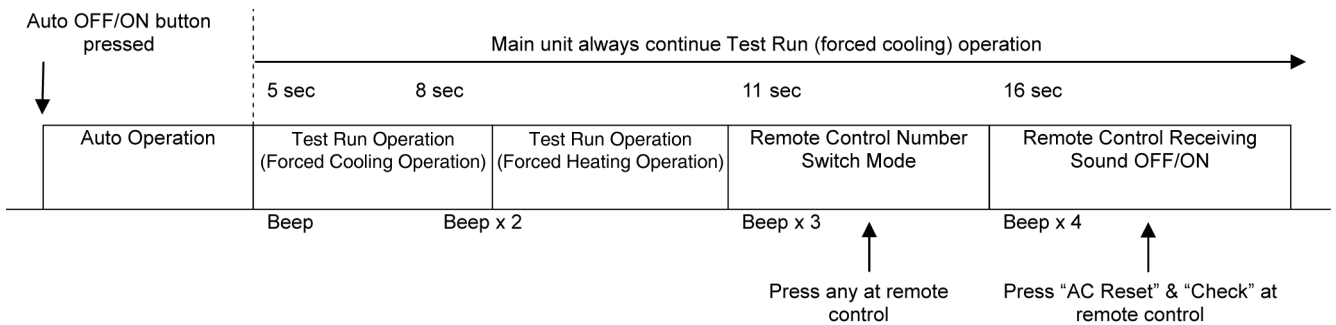

3. REMOTE CONTROL NUMBER SWITCH MODE

The Remote Control Number Switch Mode will be activated if the Auto OFF/ON button is pressed continuously for more than 11 seconds (3 “beep” sounds will occur at 11th seconds to identify the Remote Control Number Switch Mode is in standby condition) and press any button at remote control to transmit and store the desired transmission code to the EEPROM.

- There are 4 types of remote control transmission code could be selected and stored in EEPROM of indoor unit. The indoor unit will only operate when received signal with same transmission code from remote control. This could prevent signal interference when there are 2 or more indoor units installed nearby together.
- To change remote control transmission code, short or open jumpers at the remote control printed circuit board.

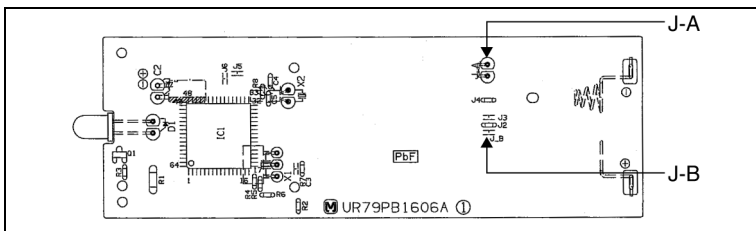

Remote Control Printed Circuit Board		
Jumper A (J-A)	Jumper B (J-B)	Remote Control No.
Short	Open	A (Default)
Open	Open	B
Short	Short	C
Open	Short	D

4. REMOTE CONTROL RECEIVING SOUND OFF/ON MODE

The Remote Control Receiving Sound OFF/ON Mode will be activated if the Auto OFF/ON button is pressed continuously for more than 16 seconds (4 “beep” sounds will occur at 16th seconds to identify the Remote Control Receiving Sound Off/On Mode is in standby condition) and press “AC Reset” button and then press “Check” button at remote control.

Press “Auto OFF/ON button” to toggle remote control receiving sound.

- Short “beep”: Turn OFF remote control receiving sound.
- Long “beep”: Turn ON remote control receiving sound.

After Auto OFF/ON Button is pressed, the 20 seconds counter for Remote Control Receiving Sound OFF/ON Mode is restarted.

14.2. Remote Control Button

14.2.1. SET BUTTON

- To check remote control transmission code and store the transmission code to EEPROM.
 - Press "SET" button for more than seconds by using pointer.
 - Press "TIMER SET" button until a "beep" sound is heard as confirmation of transmission code changed.
- To change the air quality sensor sensitivity
 - Press and release with pointer.
 - Press the Timer Decrement button to select sensitivity:
 1. Low Sensitivity
 2. Standard (Default)
 3. Hi Sensitivity
 - Confirm setting by pressing Timer Set button, a "Beep" sound will be heard. LCD returns to original display after 2 seconds.
 - LCD returns to original display if remote control does not operate for 30 seconds.

14.2.2. CLOCK BUTTON

- To change the remote control's time format
 - Press for more than 5 seconds.

14.2.3. RESET (RC)

- To clear and restore the remote control setting to factory default
 - Press once to clear the memory.

14.2.4. RESET (AC)

- To restore the unit's setting to factory default
 - Press once to restore the unit's setting.

14.2.5. TIMER ▲

- To change indoor unit indicator's LED intensity
 - Press continuously for 5 seconds.

14.2.6. TIMER ▼

- To change remote control display from Degree Celsius (°C) to Degree Fahrenheit (°F).
 - Press continuously for 10 seconds.

15 Troubleshooting Guide

15.1. Refrigeration Cycle System

In order to diagnose malfunctions, make sure that there are no electrical problems before inspecting the refrigeration cycle. Such problems include insufficient insulation, problem with the power source, malfunction of a compressor and a fan. The normal outlet air temperature and pressure of the refrigeration cycle depends on various conditions, the standard values for them are shown in the table on the right.

Normal Pressure and Outlet Air Temperature (Standard)

	Gas pressure MPa (kg/cm ² G)	Outlet air temperature (°C)
Cooling Mode	0.9 ~ 1.2 (9 ~ 12)	12 ~ 16
Heating Mode	2.3 ~ 2.9 (23 ~ 29)	36 ~ 45

- ★ Condition:
- Indoor fan speed; High
 - Outdoor temperature 35°C at cooling mode and 7°C at heating mode.
 - Compressor operates at rated frequency

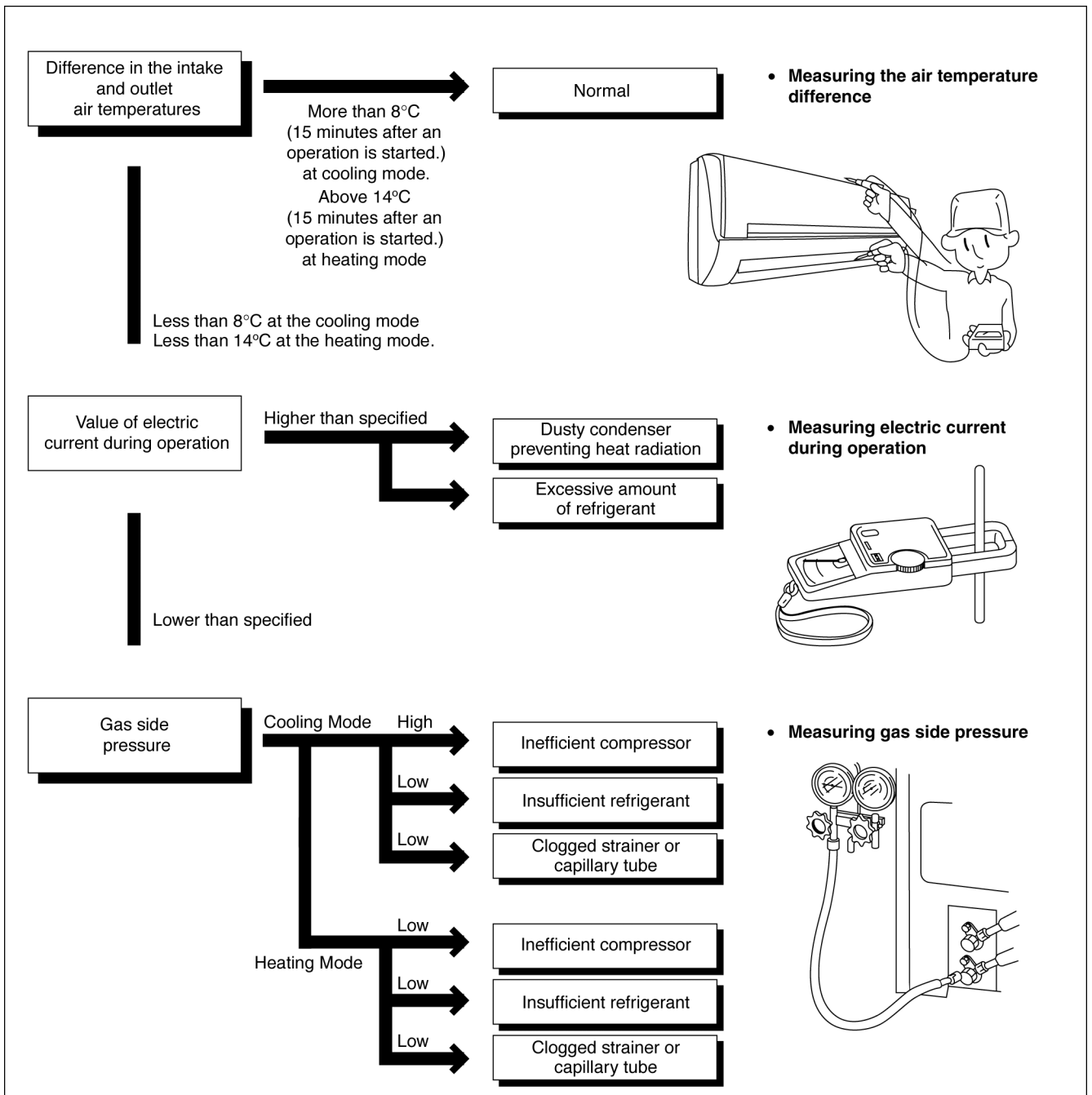

15.1.1. Relationship between the condition of the air conditioner and pressure and electric current

Condition of the air conditioner	Cooling Mode			Heating Mode		
	Low Pressure	High Pressure	Electric current during operating	Low Pressure	High Pressure	Electric current during operating
Insufficient refrigerant (gas leakage)	↘	↘	↘	↘	↘	↘
Clogged capillary tube or Strainer	↘	↘	↘	↘	↘	↘
Short circuit in the indoor unit	↘	↘	↘	↘	↘	↘
Heat radiation deficiency of the outdoor unit	↗	↗	↗	↗	↗	↗
Inefficient compression	↗	↘	↘	↗	↘	↘

- Carry out the measurements of pressure, electric current, and temperature fifteen minutes after an operation is started.

15.2. Breakdown Self Diagnosis Function

15.2.1. Self Diagnosis Function (Three Digits Alphanumeric Code)

- Once abnormality has occurred during operation, the unit will stop its operation, and Timer LED blinks.
- Although Timer LED goes off when power supply is turned off, if the unit is operated under a breakdown condition, the LED will light up again.
- In operation after breakdown repair, the Timer LED will no more blink. The last error code (abnormality) will be stored in IC memory.

• To make a diagnosis

1. Timer LED start to blink and the unit automatically stops the operation.
2. Press the CHECK button on the remote controller continuously for 5 seconds.
3. “- -” will be displayed on the remote controller display.
Note: Display only for “- -”. (No transmitting signal, no receiving sound and no Power LED blinking.)
4. Press the “TIMER” ▲ or ▼ button on the remote controller. The code “H00” (no abnormality) will be displayed and signal will be transmitted to the main unit.
5. Every press of the button (up or down) will increase abnormality numbers and transmit abnormality code signal to the main unit.
6. When the latest abnormality code on the main unit and code transmitted from the remote controller are matched, power LED will light up for 30 seconds and a beep sound (continuously for 4 seconds) will be heard. If no codes are matched, power LED will light up for 0.5 seconds and no sound will be heard.
7. The breakdown diagnosis mode will be canceled unless pressing the CHECK button continuously for 5 seconds or operating the unit for 30 seconds.
8. The LED will be off if the unit is turned off or the RESET button on the main unit is pressed.

• To display memorized error (Protective operation) status

1. Turn power on.
2. Press the CHECK button on the remote controller continuously for 5 seconds.
3. “- -” will be displayed on the remote controller display.
Note: Display only for “- -”. (No transmitting signal, no receiving sound and no Power LED blinking.)
4. Press the “TIMER” ▲ or ▼ button on the remote controller. The code “H00” (no abnormality) will be displayed and signal will be transmitted to the main unit. The power LED lights up. If no abnormality is stored in the memory, three beeps sound will be heard.
5. Every press of the button (up or down) will increase abnormality numbers and transmit abnormality code signal to the main unit.
6. When the latest abnormality code on the main unit and code transmitted from the remote controller are matched, power LED will light up for 30 seconds and a beep sound (continuously for 4 seconds) will be heard. If no codes are matched, power LED will light up for 0.5 seconds and no sound will be heard.

7. The breakdown diagnosis mode will be canceled unless pressing the CHECK button continuously for 5 seconds or operating the unit for 30 seconds.
8. The same diagnosis can be repeated by turning power on again.

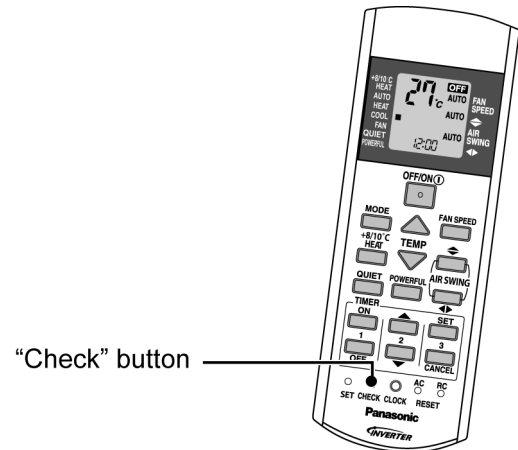

• To clear memorized error (Protective operation) status after repair:

1. Turn power on.
2. Press the AUTO button for 5 seconds (A beep receiving sound) on the main unit to operate the unit at Forced Cooling Operation modes.
3. Press the CHECK button on the remote controller for about 1 second with a pointed object to transmit signal to main unit. A beep sound is heard from main unit and the data is cleared.

• Temporary Operation (Depending on breakdown status)

1. Press the AUTO button (A beep receiving sound) on the main unit to operate the unit. (Remote control will become possible.)
2. The unit can temporarily be used until repaired.

Error Code	Operation	Temporary items
H23	Cooling	Emergency Operation with limited power
H27, H28	Cooling, Heating	

15.3. Error Codes Table

Diagnosis display	Abnormality / Protection control	Abnormality Judgement	Emergency operation	Primary location to verify
H00	No abnormality detected	—	Normal operation	
H11	Indoor / outdoor abnormal communication	> 1 min after starting operation	Indoor fan operation only	<ul style="list-style-type: none"> • Internal / external cable connections • Indoor / Outdoor PCB
H12	Connection capability rank abnormal	—	—	—
H14	Indoor intake air temperature sensor abnormality	Continue for 5 sec.	—	<ul style="list-style-type: none"> • Intake air temperature sensor (detective or disconnected)
H15	Outdoor compressor temperature sensor abnormality	Continue for 5 sec.	—	<ul style="list-style-type: none"> • Compressor temperature sensor (detective or disconnected)
H16	Outdoor Current Transformer open circuit	—	—	<ul style="list-style-type: none"> • Outdoor PCB • IPM (Power transistor) module
H19	Indoor fan motor mechanism lock	7 times occurrence continuously.	—	<ul style="list-style-type: none"> • Indoor PCB • Fan motor
H23	Indoor heat exchanger temperature sensor abnormality	Continue for 5 sec.	O (Cooling only)	<ul style="list-style-type: none"> • Heat exchanger temperature sensor (detective or disconnected)
H25	E-Ion breakdown	—	—	<ul style="list-style-type: none"> • Indoor PCB • E-Ion PCB
H27	Outdoor air temperature sensor abnormality	Continue for 5 sec.	O	<ul style="list-style-type: none"> • Outdoor temperature sensor (defective or disconnected)
H28	Outdoor heat exchanger temperature sensor abnormality	Continue for 5 sec.	O	<ul style="list-style-type: none"> • Outdoor heat exchanger temperature sensor (defective or disconnected)
H30	Outdoor discharge pipe temperature sensor abnormality	Continue for 5 sec.	Outdoor discharge pipe temperature sensor open or short circuit	<ul style="list-style-type: none"> • Outdoor discharge pipe temperature sensor lead wire and connector
H33	Indoor/Outdoor wrong connection	—	—	<ul style="list-style-type: none"> • Indoor/Outdoor supply voltage
H38	Indoor/outdoor mismatch (brand code)	—	—	—
H58	Abnormal gas sensor	Continue for 6 hours	—	<ul style="list-style-type: none"> • Gas sensor (defective or disconnected)
H97	Outdoor fan motor mechanism lock	2 times happen within 30 minutes	Outdoor fan motor lock or feedback abnormal	<ul style="list-style-type: none"> • Outdoor fan motor lead wire and connector • Fan motor lock or block
H98	Indoor high pressure protection	—	—	<ul style="list-style-type: none"> • Air filter dirty • Air circulation short circuit
H99	Indoor heat exchanger anti-freezing protection	—	—	<ul style="list-style-type: none"> • Insufficient refrigerant • Air filter dirty
F11	Cooling / Heating cycle changeover abnormality	4 times occurrence within 30 minutes	—	<ul style="list-style-type: none"> • 4-way valve • V-coil
F90	PFC control	4 times occurrence within 20 minutes	—	<ul style="list-style-type: none"> • Voltage at PFC
F91	Refrigeration cycle abnormal	2 times occurrence within 20 minutes	—	<ul style="list-style-type: none"> • No refrigerant (3-way valve is closed)
F93	Outdoor compressor abnormal revolution	4 times occurrence within 20 minutes	—	<ul style="list-style-type: none"> • Outdoor compressor
F95	Cool high pressure protection	4 times occurrence within 20 minutes	—	<ul style="list-style-type: none"> • Outdoor refrigerant circuit
F96	IPM (power transistor) overheating protection	—	—	<ul style="list-style-type: none"> • Excess refrigerant • Improper heat radiation • IPM (Power transistor)
F97	Outdoor compressor overheating protection	4 times occurrence within 20 minutes	—	<ul style="list-style-type: none"> • Insufficient refrigerant • Compressor
F98	Total running current protection	3 times occurrence within 20 minutes	—	<ul style="list-style-type: none"> • Excess refrigerant • Improper heat radiation
F99	Outdoor Direct Current (DC) peak detection	7 times occurrence continuously	—	<ul style="list-style-type: none"> • Outdoor PCB • IPM (Power transistor) • Compressor

Note:

“O” - Frequency measured and fan speed fixed.

The memory data of error code is erased when the power supply is cut off, or press the Auto Switch until “beep” sound heard following by pressing the “CHECK” button at Remote Control.

Although operation forced to stop when abnormality detected, emergency operation is possible for certain errors (refer to Error Codes Table) by using Remote Control or Auto Switch at indoor unit. However, the Remote Control signal receiving sound is changed from one “beep” to four “beep” sounds.

15.4. Self-diagnosis Method

15.4.1. H11 (Indoor/Outdoor Abnormal Communication)

Malfunction Decision Conditions

During startup and operation of cooling and heating, the data received from outdoor unit in indoor unit signal transmission is checked whether it is normal.

Malfunction Caused

- Faulty indoor unit PCB.
- Faulty outdoor unit PCB.
- Indoor unit-outdoor unit signal transmission error due to wrong wiring.
- Indoor unit-outdoor unit signal transmission error due to breaking of wire in the connection wires between the indoor and outdoor units.
- Indoor unit-outdoor unit signal transmission error due to disturbed power supply waveform.

Troubleshooting

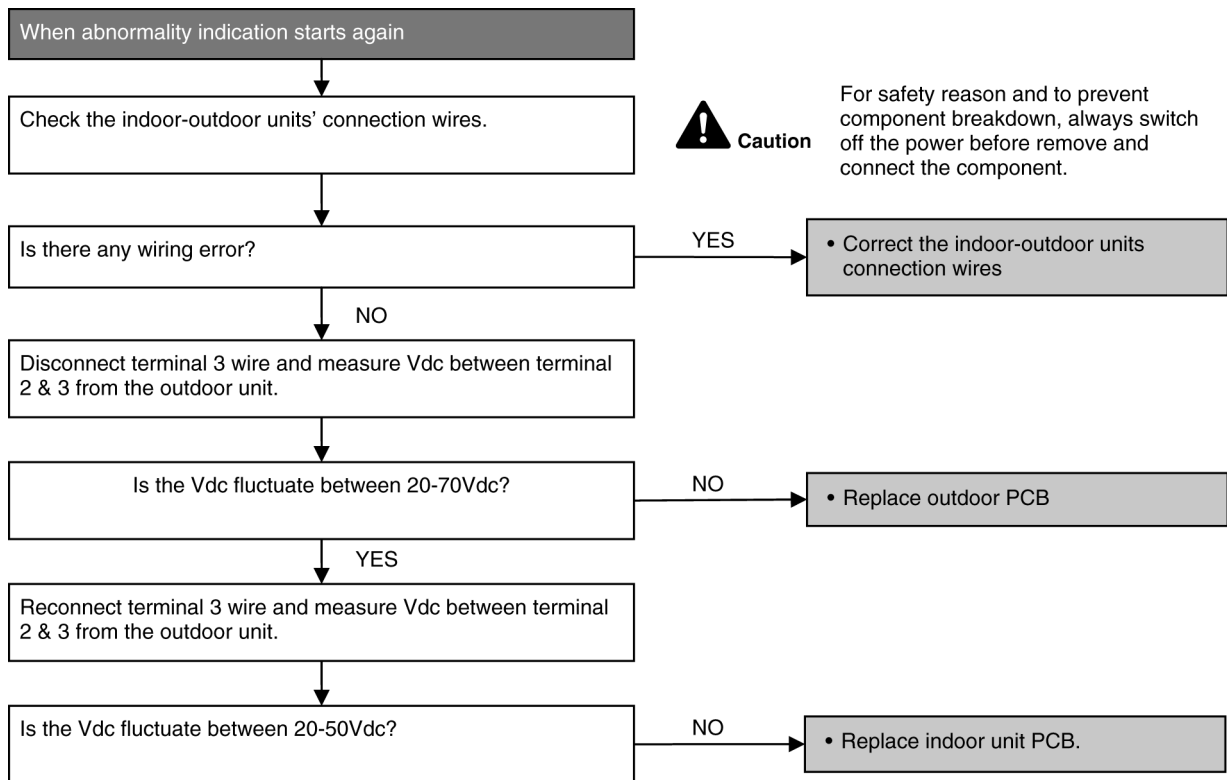

15.4.2. H12 (Indoor/Outdoor Capacity Rank Mismatched)

Malfunction Decision Conditions

During startup, error code appears when different types of indoor and outdoor units are interconnected.

Malfunction Caused

- Wrong models interconnected.
- Wrong indoor unit or outdoor unit PCBs mounted.
- Indoor unit or outdoor unit PCBs defective.
- Indoor-outdoor unit signal transmission error due to wrong wiring.
- Indoor-outdoor unit signal transmission error due to breaking of wire 3 in the connection wires between the indoor and outdoor units.

Troubleshooting

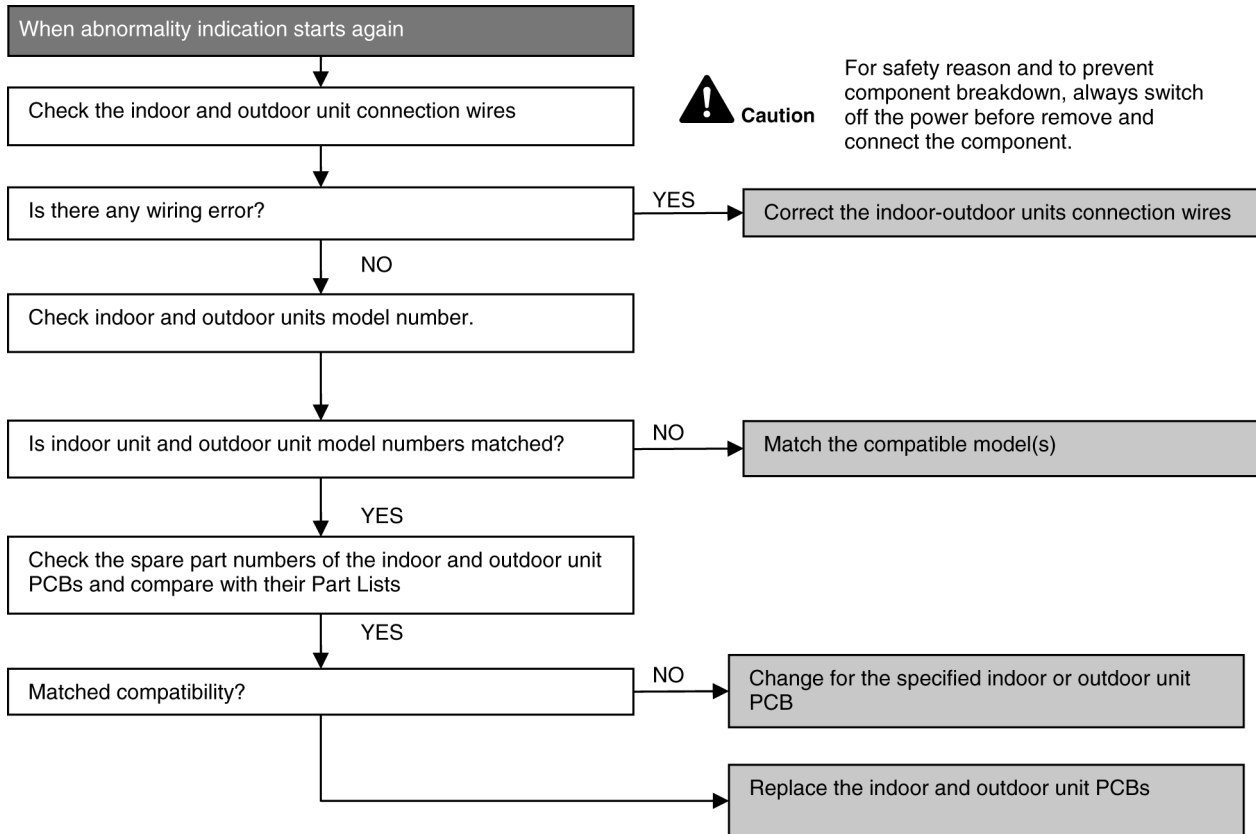

15.4.3. H14 (Indoor Intake Air Temperature Sensor Abnormality)

Malfunction Decision Conditions

During startup and operation of cooling and heating, the temperatures detected by the indoor intake air temperature sensor are used to determine sensor errors.

Malfunction Caused

- Faulty connector connection.
- Faulty sensor.
- Faulty PCB.

Troubleshooting

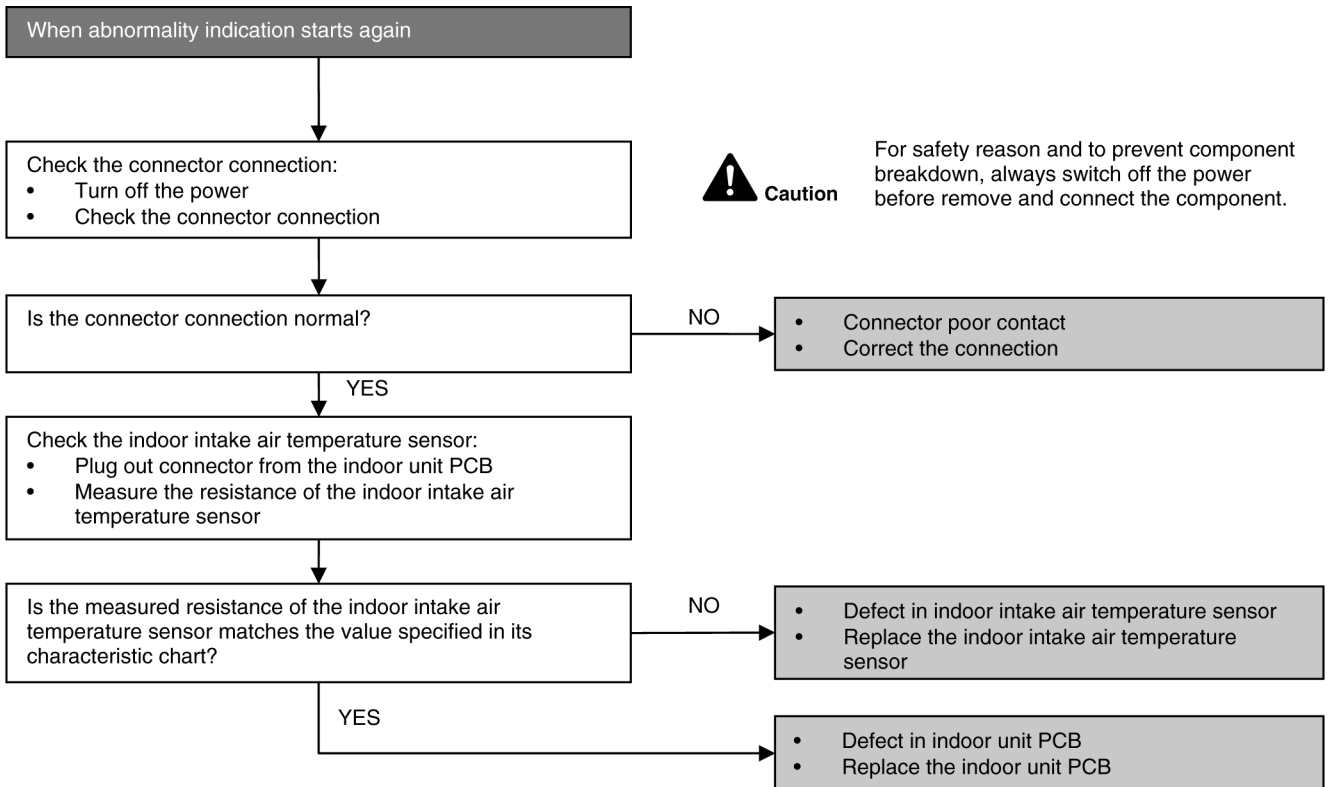

Caution

For safety reason and to prevent component breakdown, always switch off the power before remove and connect the component.

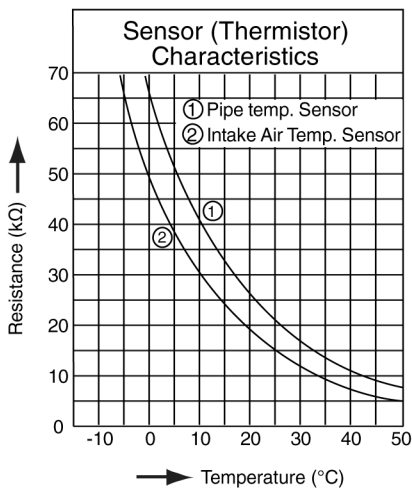

15.4.4. H15 (Compressor Temperature Sensor Abnormality)

Malfunction Decision Conditions

During startup and operation of cooling and heating, the temperatures detected by the outdoor compressor temperature sensor are used to determine sensor errors.

Malfunction Caused

- Faulty connector connection.
- Faulty sensor.
- Faulty PCB.

Troubleshooting

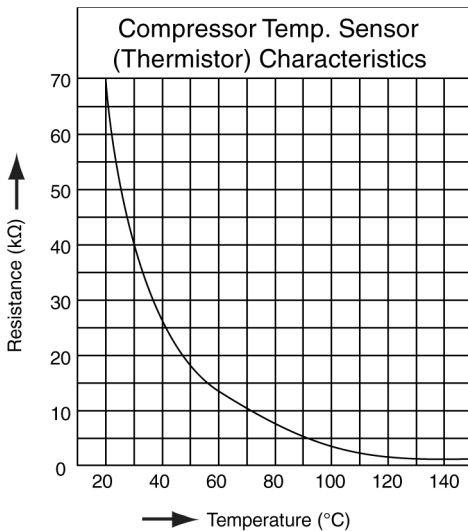
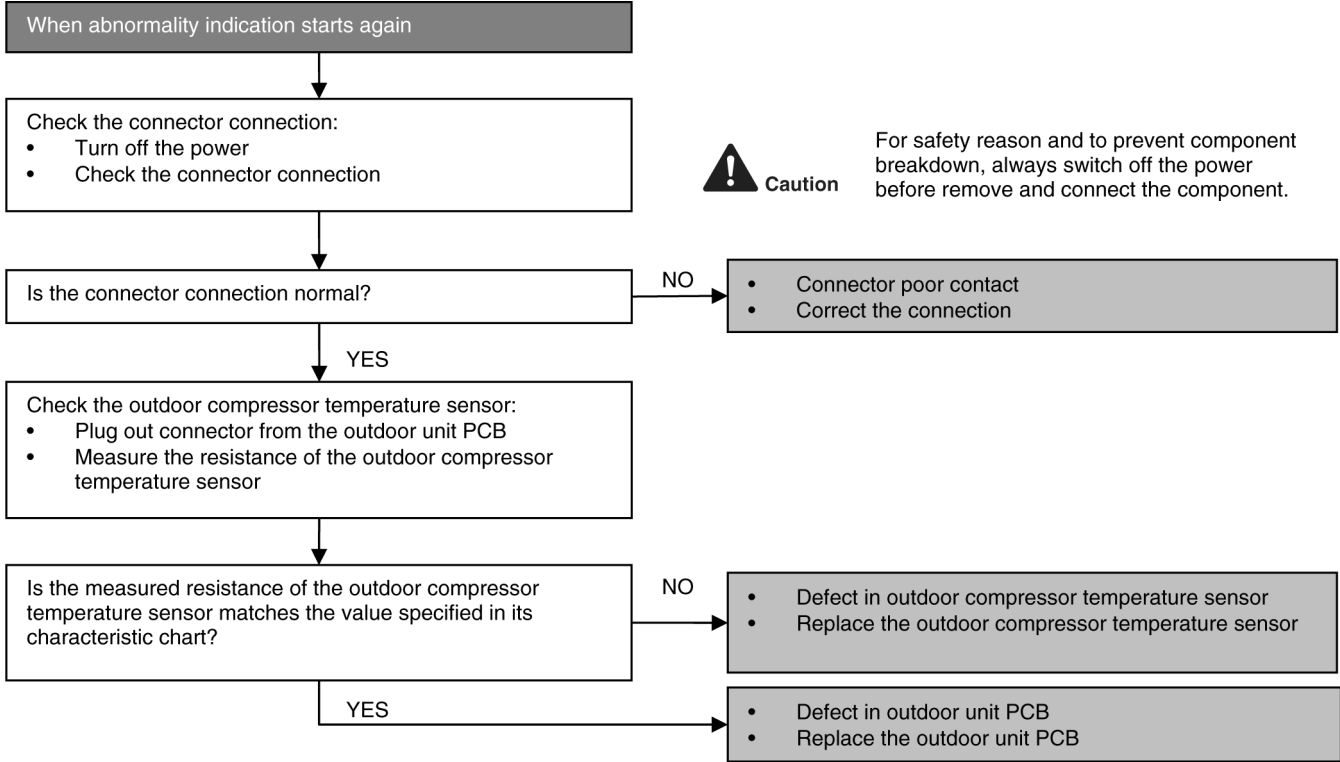

15.4.5. H16 (Outdoor Current Transformer Open Circuit)

Malfunction Decision Conditions

A current transformer (CT) is detected by checking the compressor running frequency (\geq rated frequency) and CT detected input current (less than 0.65A) for continuously 20 seconds.

Malfunction Caused

- CT defective
- Outdoor PCB defective
- Compressor defective (low compression)

Troubleshooting

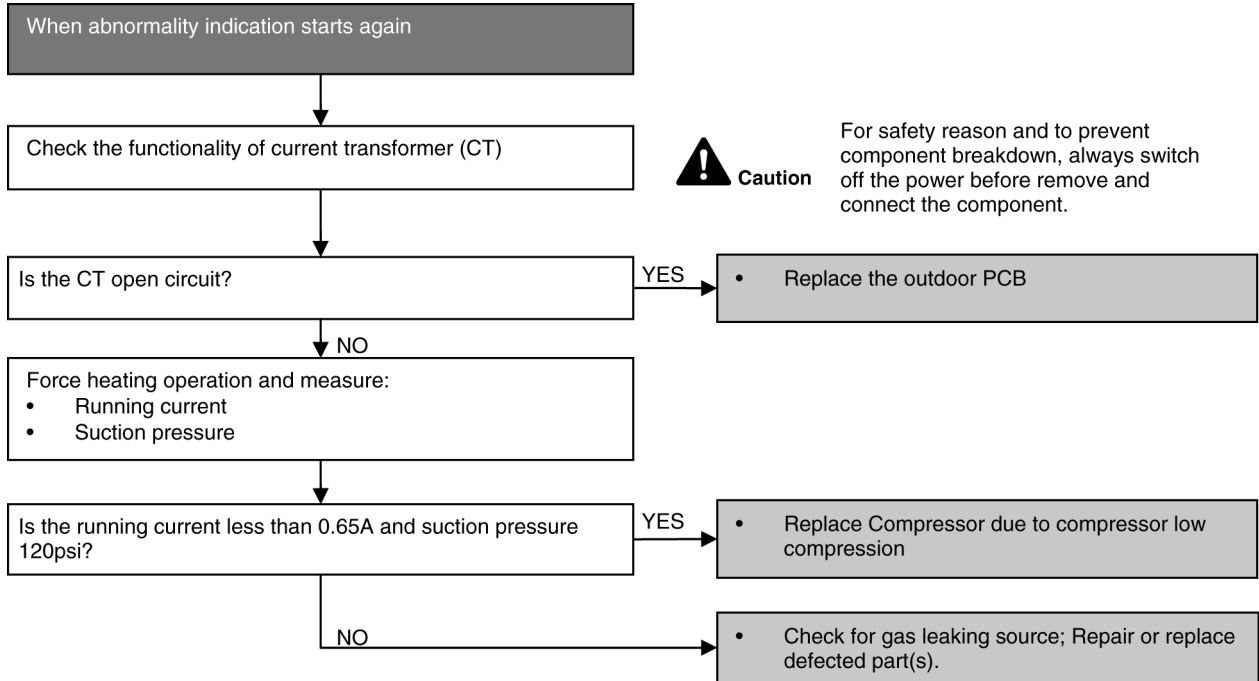

15.4.6. H19 (Indoor Fan Motor - DC Motor Mechanism Locked)

Malfunction Decision Conditions

The rotation speed detected by the Hall IC during fan motor operation is used to determine abnormal fan motor (feedback of rotation > 2550rpm or < 50rpm)

Malfunction Caused

- Operation stops due to short circuit inside the fan motor winding.
- Operation stops due to breaking of wire inside the fan motor.
- Operation stops due to breaking of fan motor lead wires.
- Operation stops due to Hall IC malfunction.
- Operation error due to faulty indoor unit PCB.

Troubleshooting

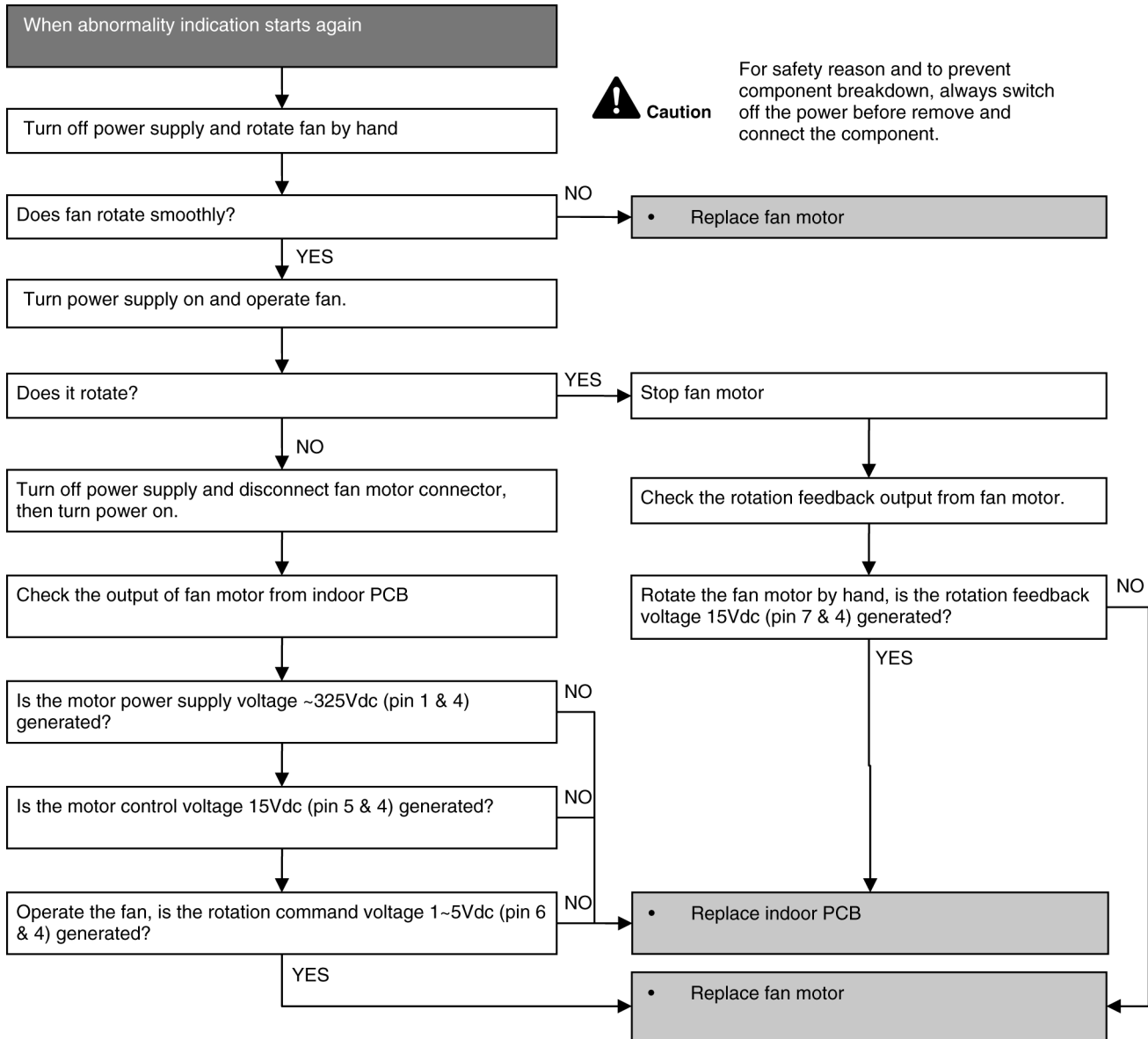

15.4.7. H23 (Indoor Pipe Temperature Sensor Abnormality)

Malfunction Decision Conditions

During startup and operation of cooling and heating, the temperatures detected by the indoor heat exchanger temperature sensor are used to determine sensor errors.

Malfunction Caused

- Faulty connector connection.
- Faulty sensor.
- Faulty PCB.

Troubleshooting

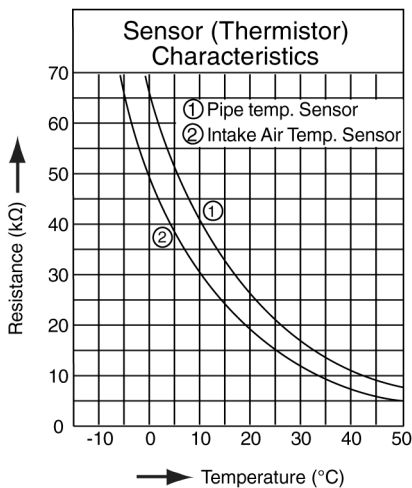
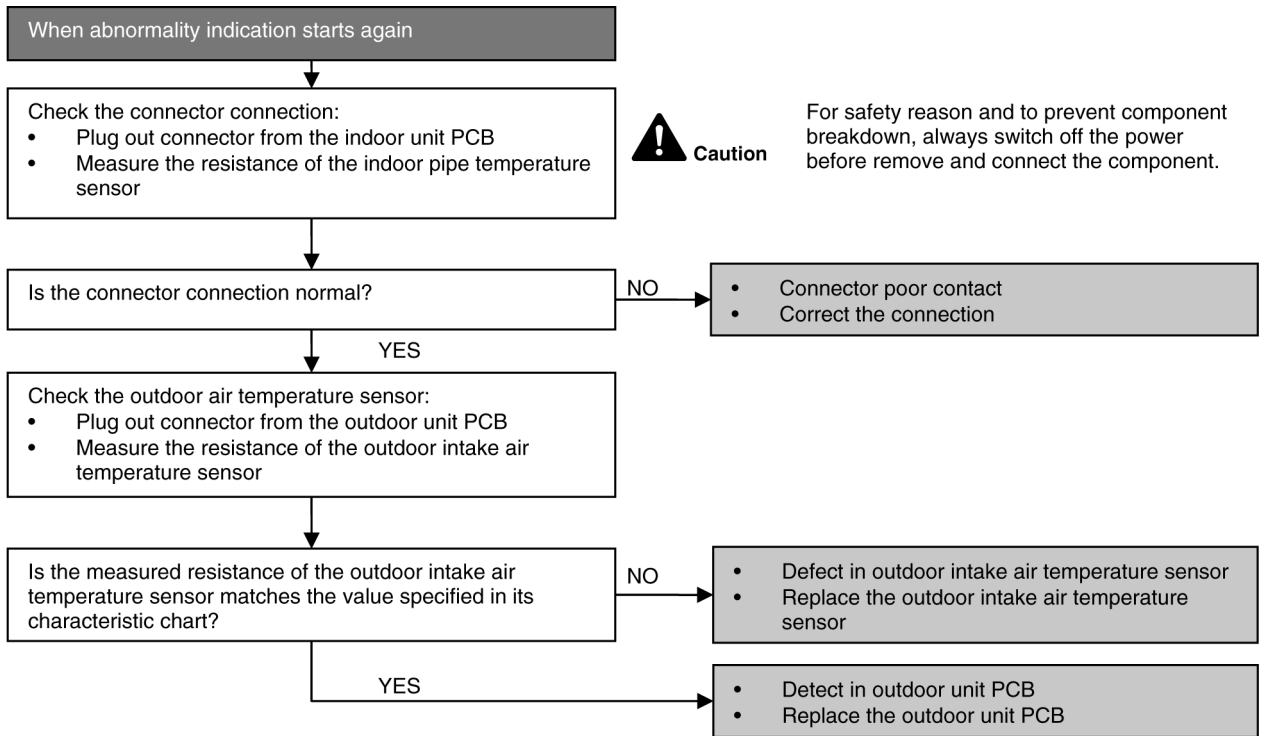

15.4.8. H25 (e-ion Air Purifying System Abnormal)

Malfunction Decision Conditions

During standby of cooling and heating operation, e-ion breakdown occurs and air conditioner stops operation.

Malfunction Caused

- Faulty indoor main PCB.
- Faulty indoor e-ion power module.

Troubleshooting

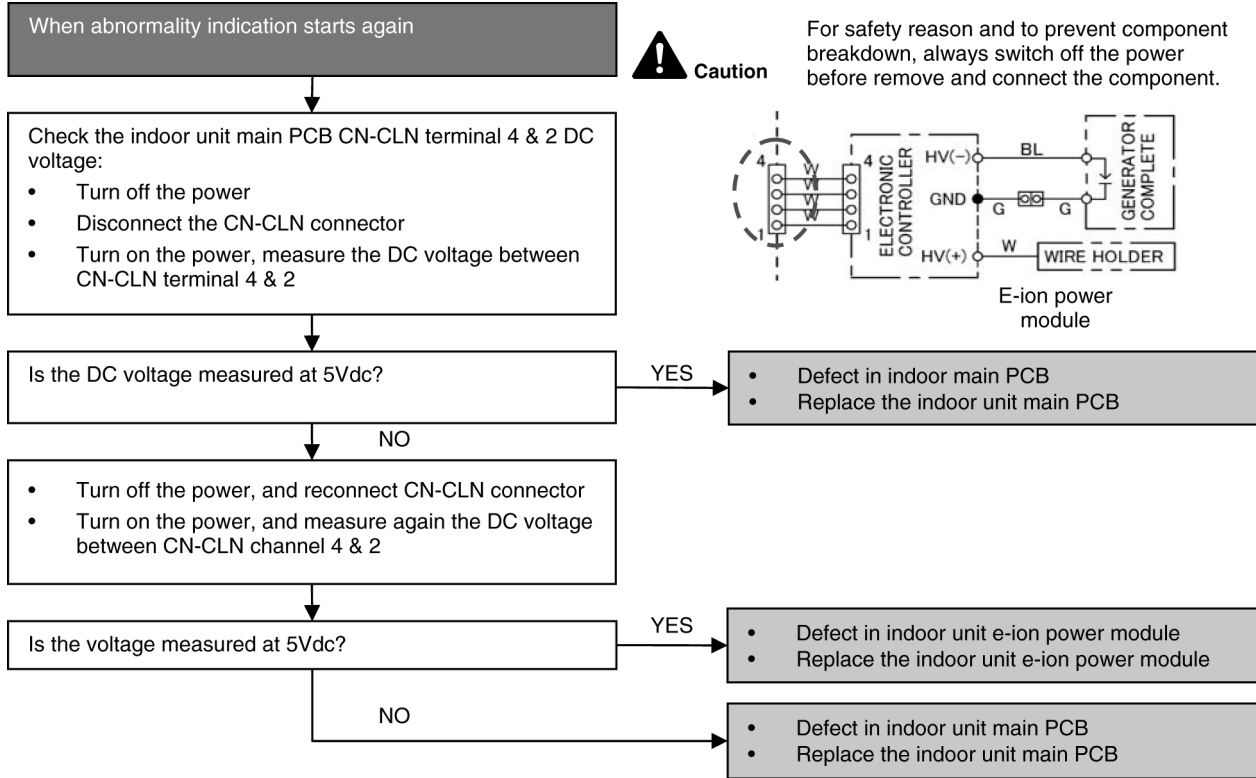

15.4.9. H27 (Outdoor Air Temperature Sensor Abnormality)

Malfunction Decision Conditions

During startup and operation of cooling and heating, the temperatures detected by the outdoor air temperature sensor are used to determine sensor errors.

Malfunction Caused

- Faulty connector connection.
- Faulty sensor.
- Faulty PCB.

Troubleshooting

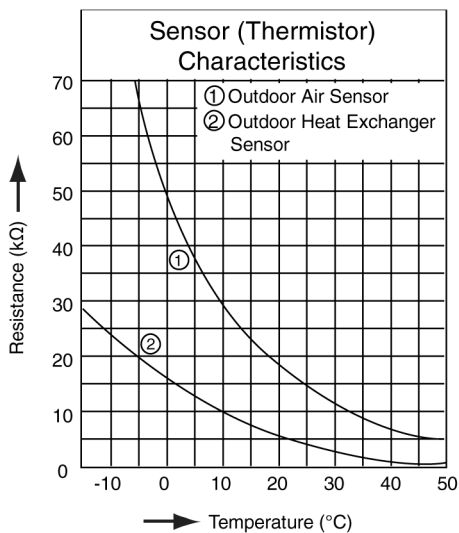
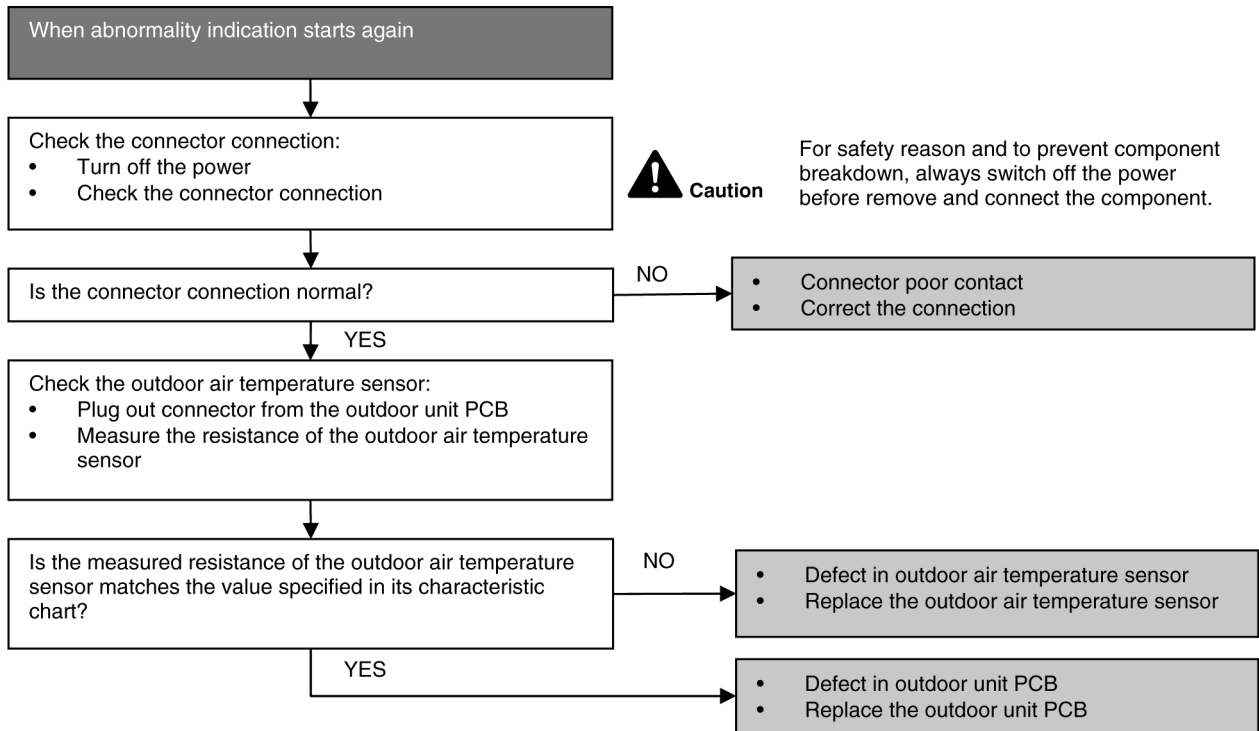

15.4.10. H28 (Outdoor Pipe Temperature Sensor Abnormality)

Malfunction Decision Conditions

During startup and operation of cooling and heating, the temperatures detected by the outdoor pipe temperature sensor are used to determine sensor errors.

Malfunction Caused

- Faulty connector connection.
- Faulty sensor.
- Faulty PCB.

Troubleshooting

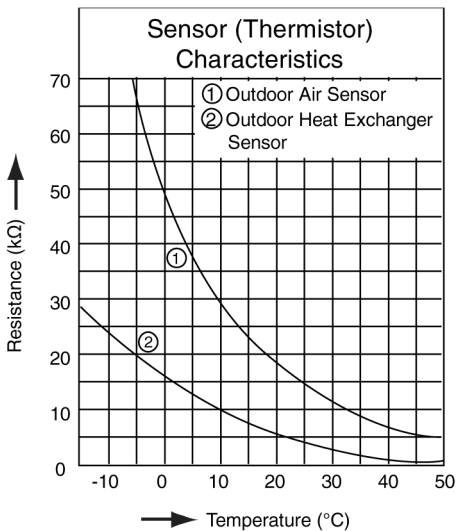
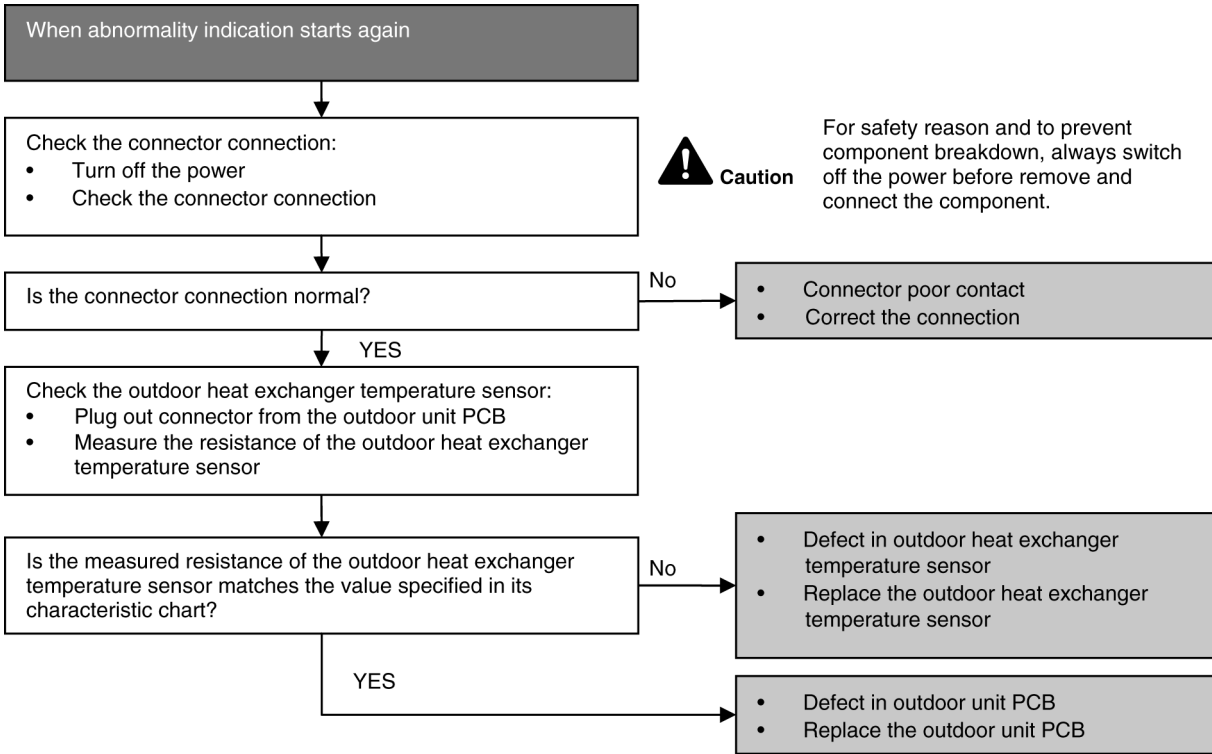

15.4.11. H30 (Compressor Discharge Temperature Sensor Abnormality)

Malfunction Decision Conditions

During startup and operation of cooling and heating, the temperatures detected by the outdoor discharge pipe temperature sensor are used to determine sensor errors.

Malfunction Caused

- Faulty connector connection.
- Faulty sensor.
- Faulty PCB.

Troubleshooting

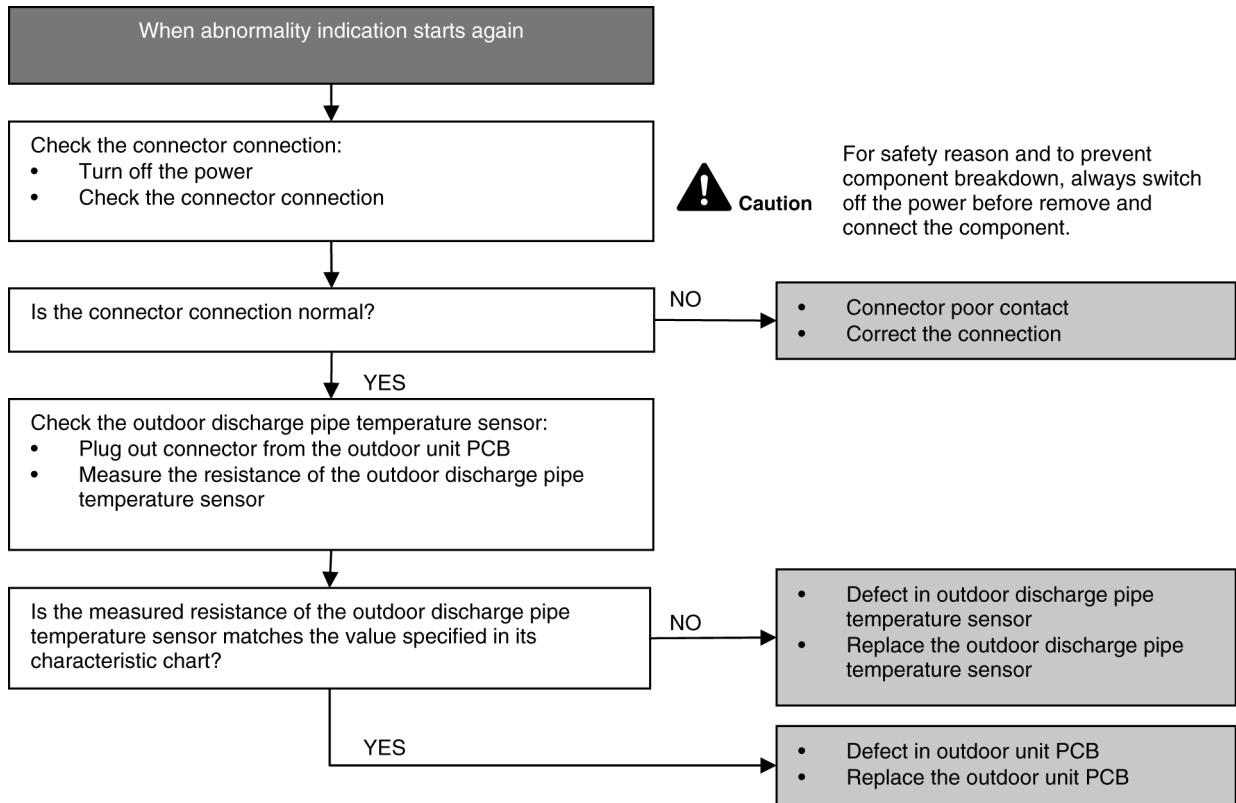

15.4.12. H33 (Unspecified Voltage between Indoor and Outdoor)

Malfunction Decision Conditions

The supply power is detected for its requirement by the indoor/outdoor transmission.

Malfunction Caused

- Wrong models interconnected.
- Wrong indoor unit and outdoor unit PCBs used.
- Indoor unit or outdoor unit PCB defective.

Troubleshooting

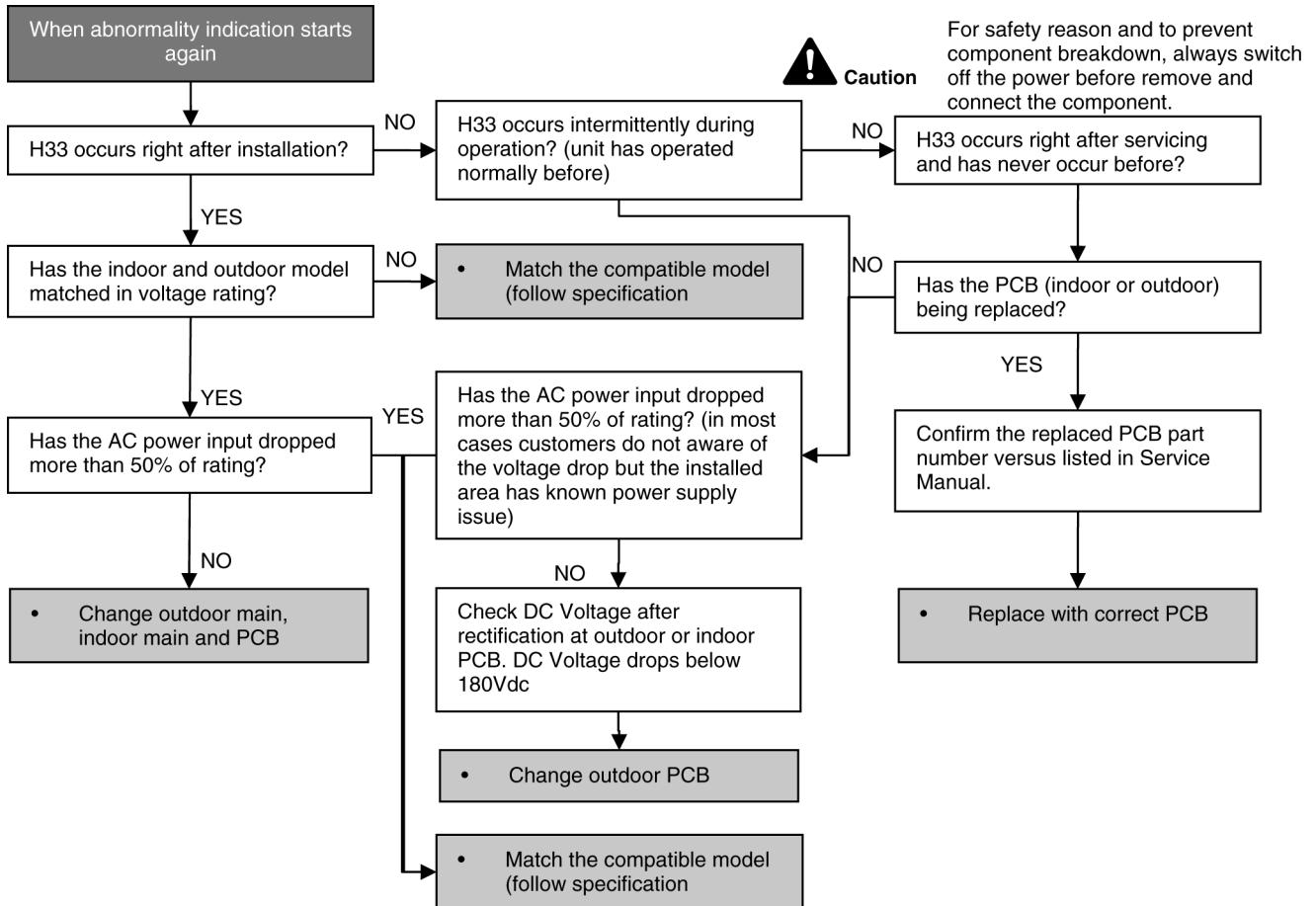

15.4.13. H58 (Patrol Sensor Abnormality)

Malfunction Decision Conditions

- If Patrol sensor feedback is 0V or 5V continuous for 6 hours.
- Error will display only when the Patrol operation is ON.

Malfunction Caused

- Faulty connector connection.
- Faulty Patrol sensor.

Troubleshooting

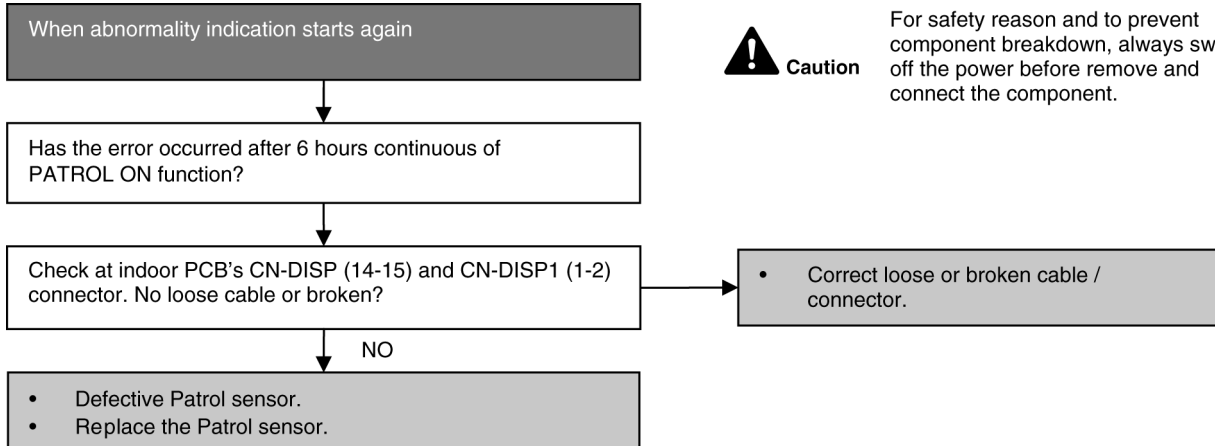

Caution

For safety reason and to prevent component breakdown, always switch off the power before remove and connect the component.

15.4.14. H97 (Outdoor Fan Motor - DC Motor Mechanism Locked)

Malfunction Decision Conditions

The rotation speed detected by the Hall IC during fan motor operation is used to determine abnormal fan motor.

Malfunction Caused

- Operation stops due to short circuit inside the fan motor winding.
- Operation stops due to breaking of wire inside the fan motor.
- Operation stops due to breaking of fan motor lead wires.
- Operation stops due to Hall IC malfunction.
- Operation error due to faulty outdoor unit PCB.

Troubleshooting

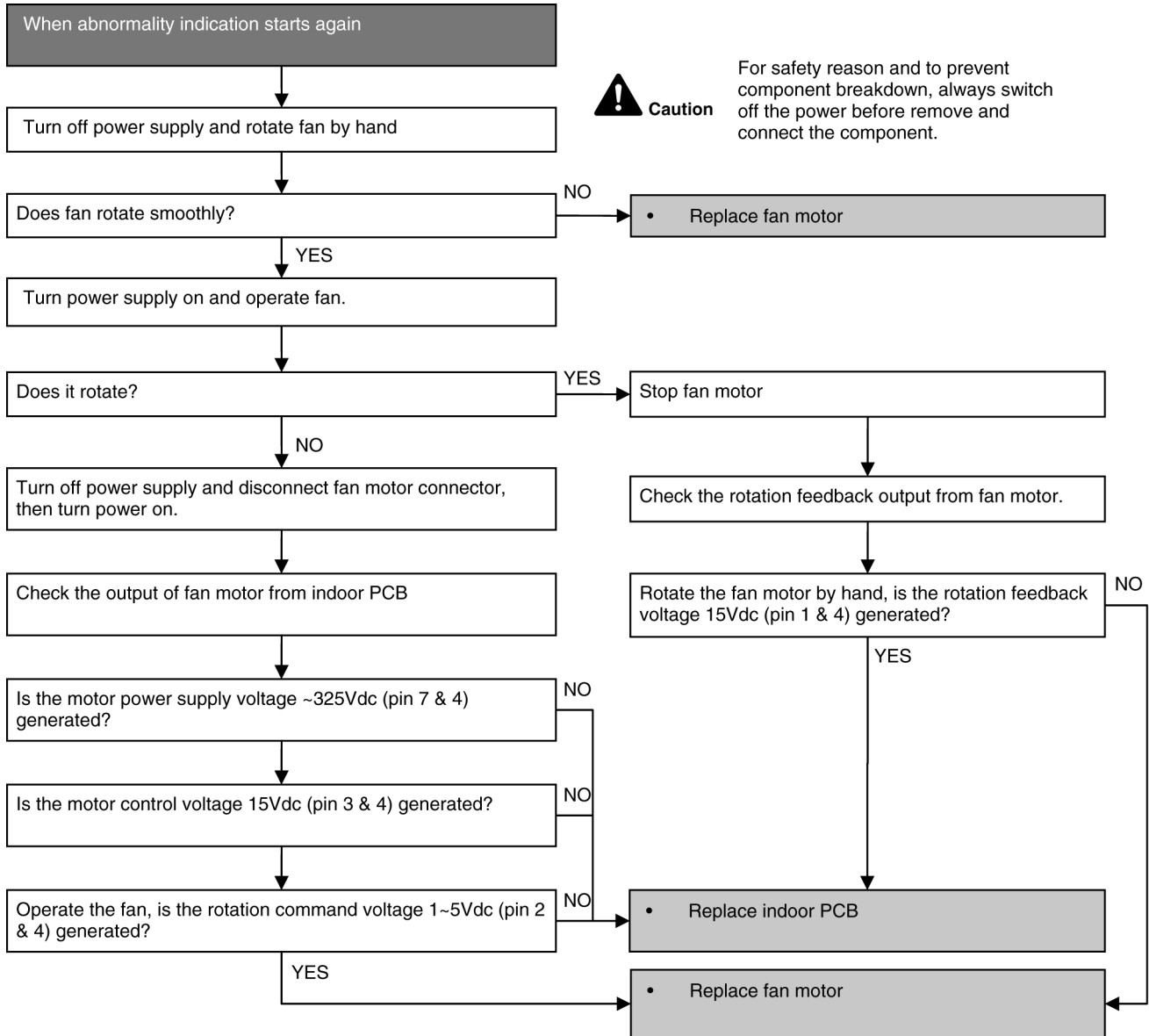

15.4.15. H98 (Indoor High Pressure Protection)

Error Code will not display (no Timer LED blinking) but store in EEPROM

Malfunction Decision Conditions

During heating operation, the temperature detected by the indoor pipe temperature sensor is above 60°C.

Malfunction Caused

- Clogged air filter of the indoor unit
- Dust accumulation on the indoor unit heat exchanger
- Air short circuit
- Detection error due to faulty indoor pipe temperature sensor
- Detection error due to faulty indoor unit PCB

Troubleshooting

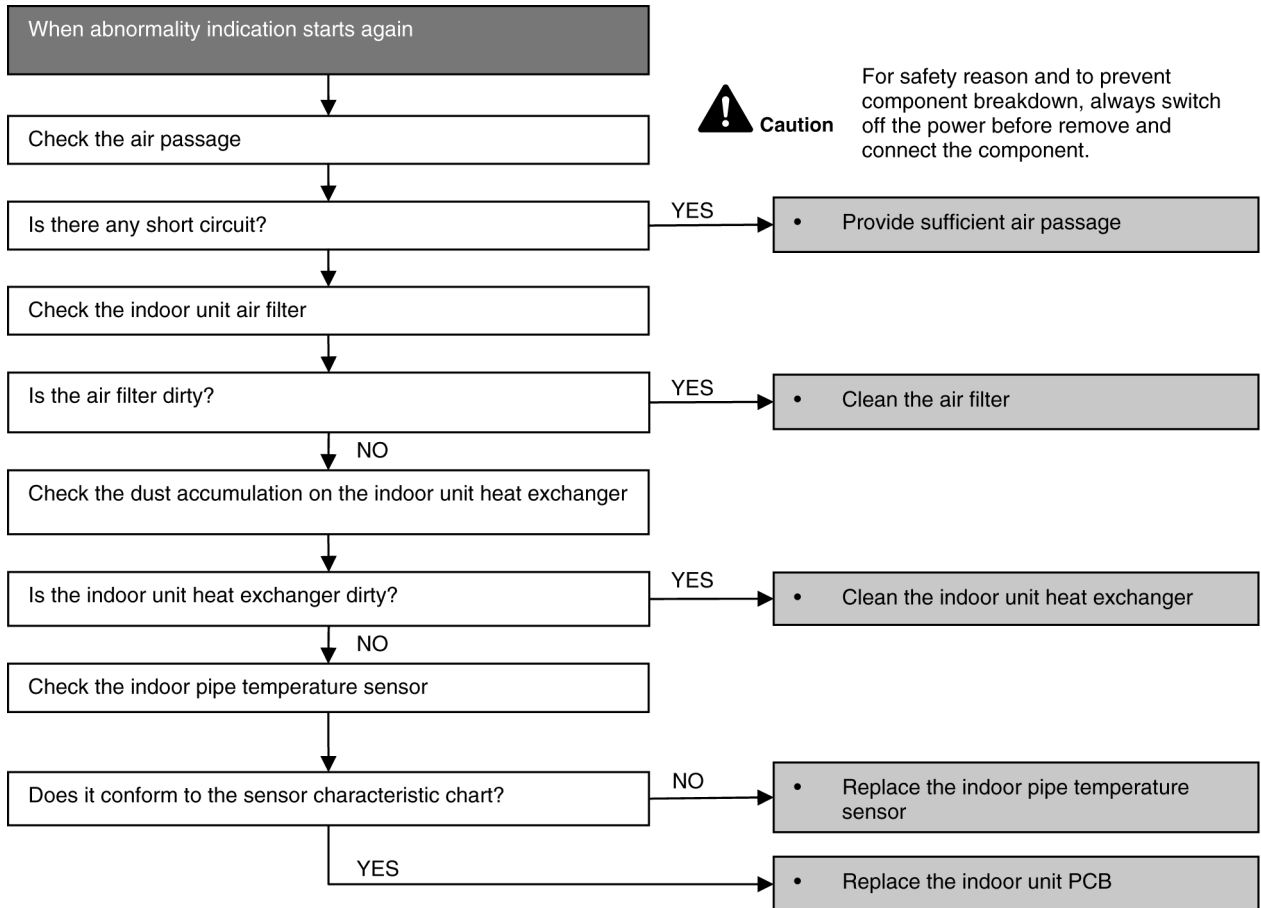

15.4.16. H99 (Indoor Freeze Prevention Protection: Cooling or Soft Dry)

Error code will not display (no TIMER LED blinking) but store in EEPROM

Malfunction Decision Conditions

Freeze prevention control takes place (when indoor pipe temperature is lower than 2°C)

Malfunction Caused

- Clogged air filter of the indoor unit
- Dust accumulation on the indoor unit heat exchanger
- Air short circuit
- Detection error due to faulty indoor pipe temperature sensor
- Detection error due to faulty indoor unit PCB

Troubleshooting

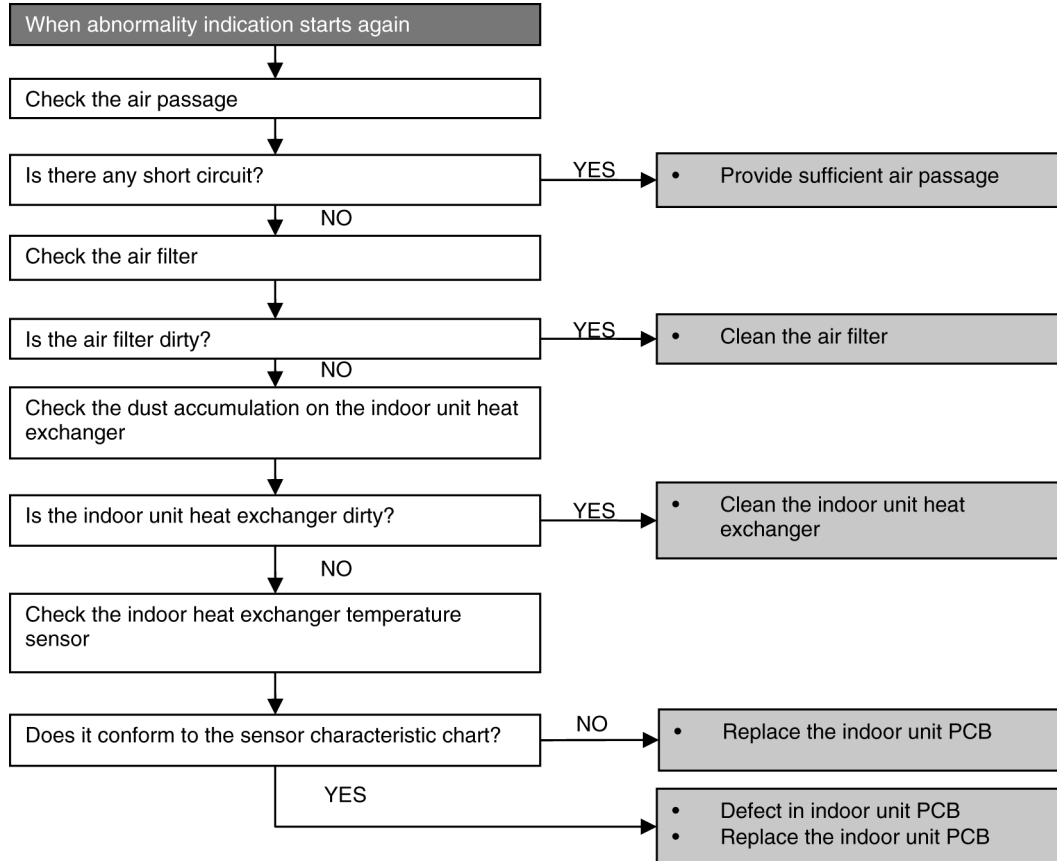

15.4.17. F11 (4-way valve Abnormality)

Malfunction Decision Conditions

- When heating operation, when indoor pipe temperature is below 10°C
- When cooling operation, when indoor pipe temperature is above 45°C

Malfunction Caused

- Connector in poor contact
- Faulty sensor
- Faulty outdoor unit PCB
- 4-way valve defective

Troubleshooting

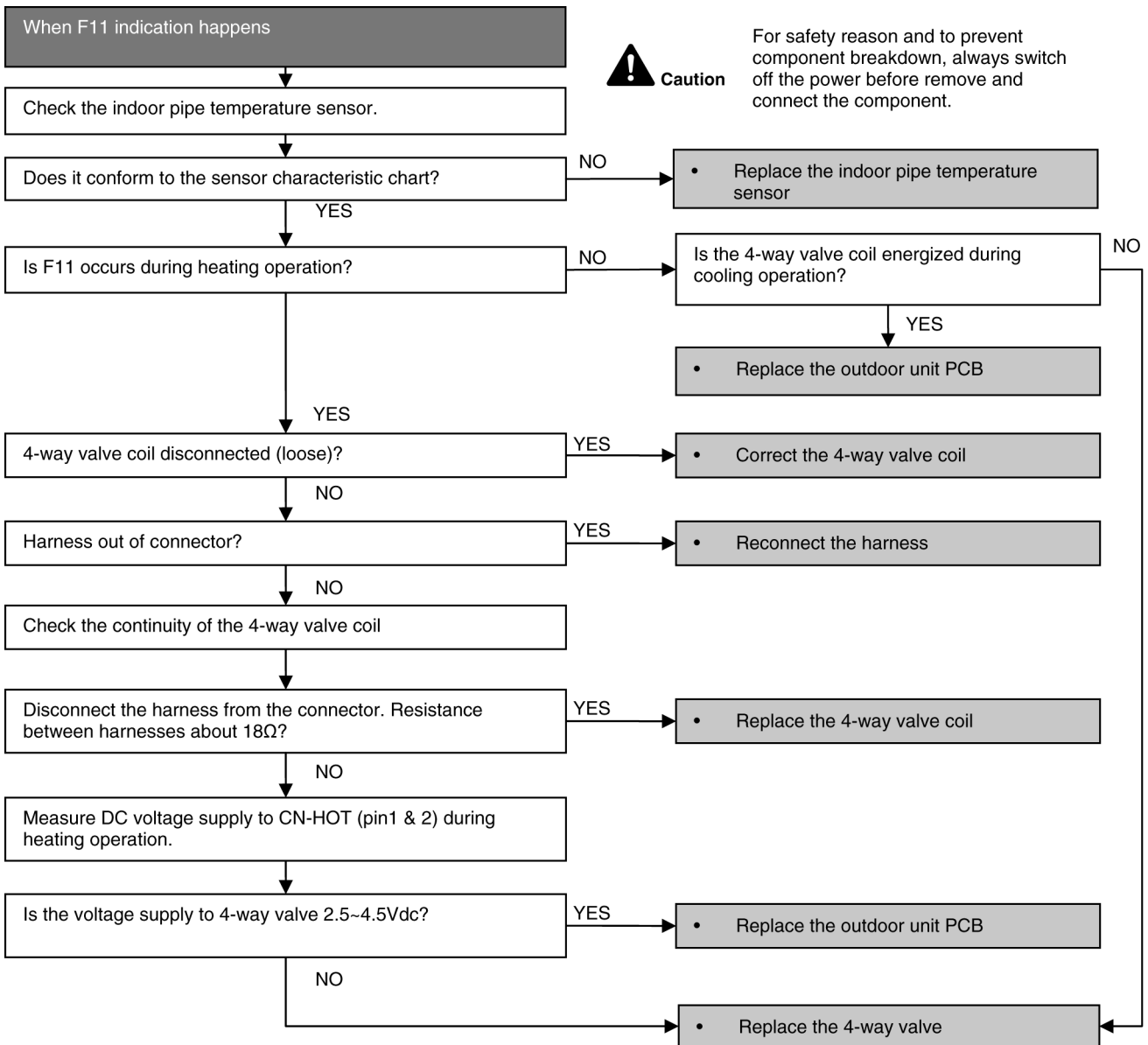

15.4.18. F90 (Power Factor Correction Protection)

Malfunction Decision Conditions

During startup and operation of cooling and heating, when Power Factor Correction (PFC) protection circuitry at the outdoor unit main PCB senses abnormal high DC voltage level.

Malfunction Caused

- DC voltage peak due to power supply surge.
- DC voltage peak due to compressor windings not uniform.
- Faulty outdoor PCB.

Troubleshooting

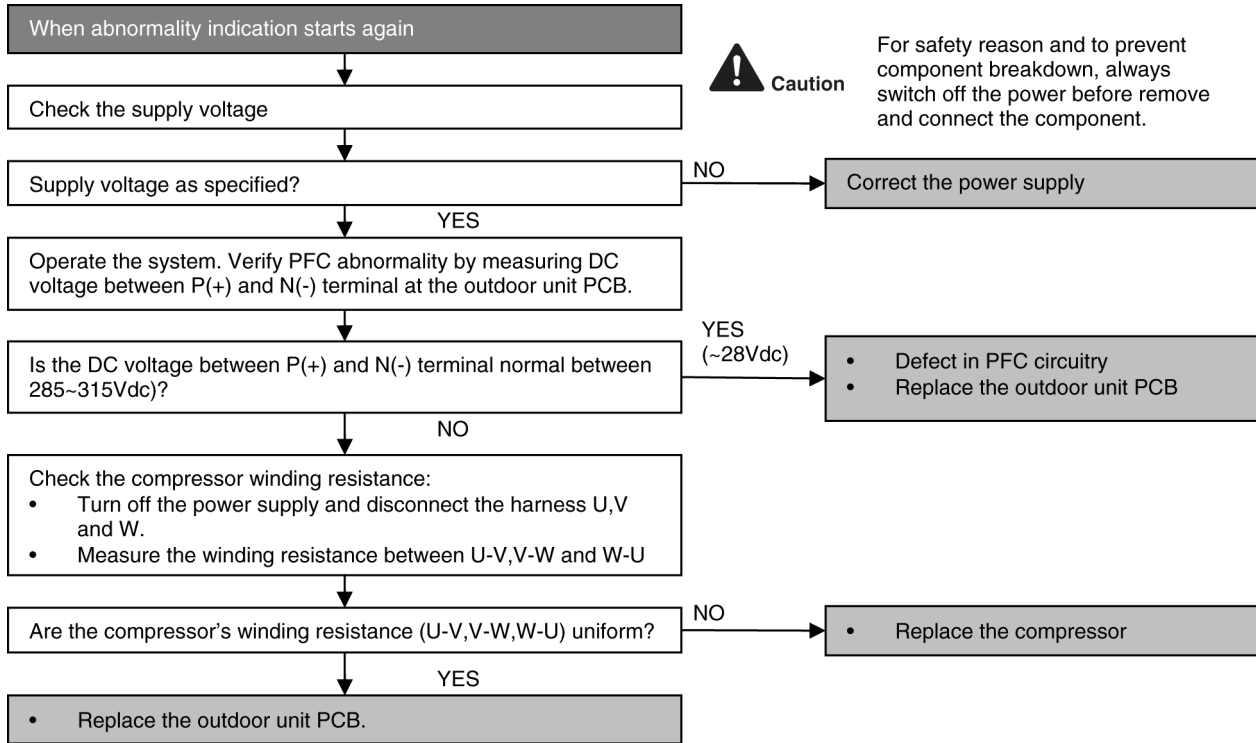

15.4.19. F91 (Refrigeration Cycle Abnormality)

Malfunction Decision Conditions

- During cooling, compressor frequency = F_{cmax}.
- During heating, compressor frequency > F_{hrated}.
- During cooling and heating operation, running current: 0.65A < I < 1.65A.
- During cooling, indoor intake - indoor pipe < 4°C
- During heating, indoor pipe - indoor intake < 5°C

Multi Models Only

- Gas shortage detection 1: A gas shortage is detected by checking the CT-detected input current value and the compressor running frequency. During startup and operating of cooling and heating, input current < 8.78/256 (A/Hz) x compressor running frequency + 0.25.
- Gas shortage detection 2: A gas shortage is detected by checking the difference between indoor pipe temperature and indoor intake air temperature during cooling and heating.

Malfunction Caused

- Refrigerant shortage (refrigerant leakage)
- Poor compression performance of compressor.
- 2/3 way valve closed.
- Detection error due to faulty indoor intake air or indoor pipe temperature sensors.

Troubleshooting

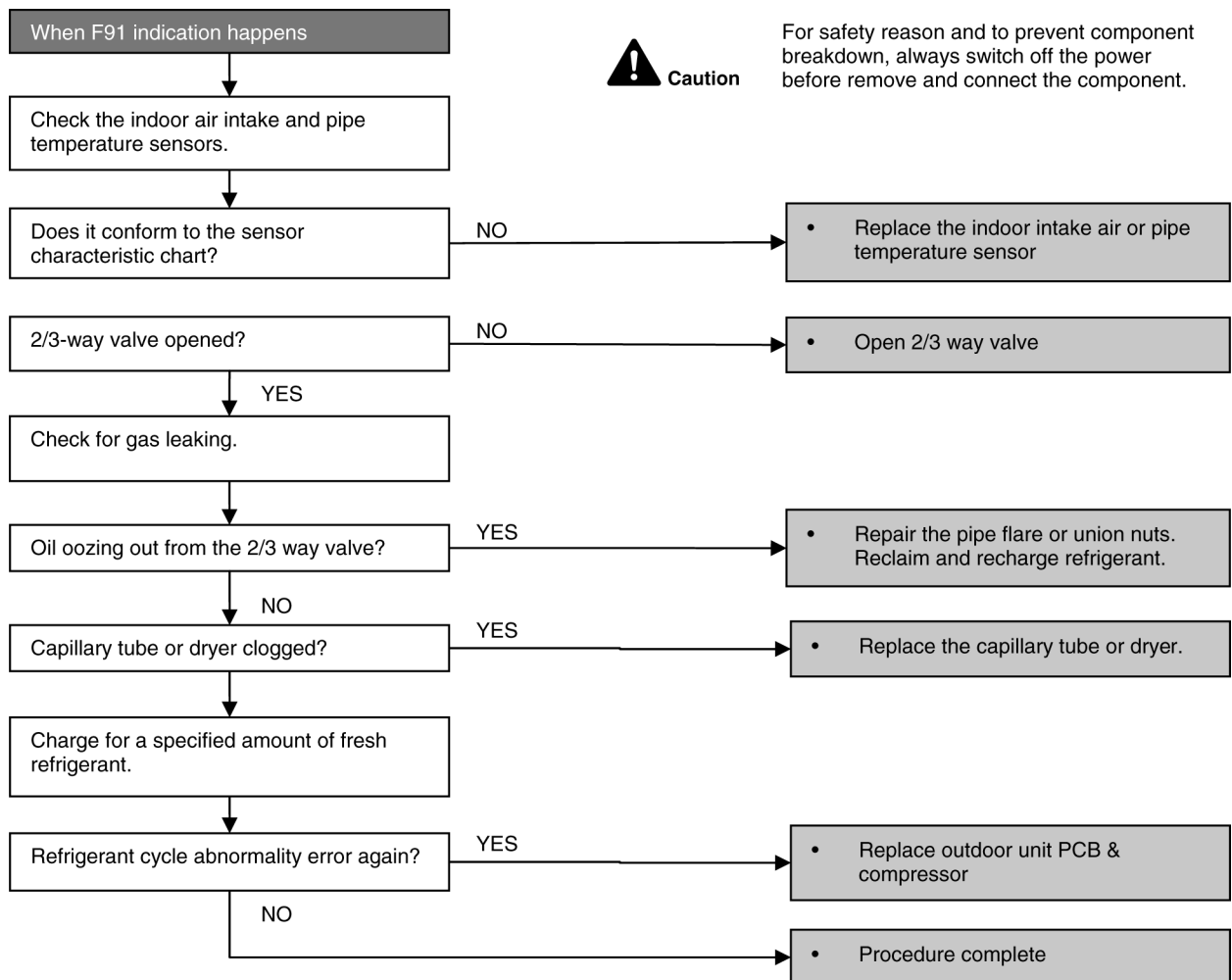

Caution

For safety reason and to prevent component breakdown, always switch off the power before remove and connect the component.

15.4.20. F93 (Compressor Rotation Failure)

Malfunction Decision Conditions

A compressor rotation failure is detected by checking the compressor running condition through the position detection circuit.

Malfunction Caused

- Compressor terminal disconnect
- Outdoor PCB malfunction

Troubleshooting

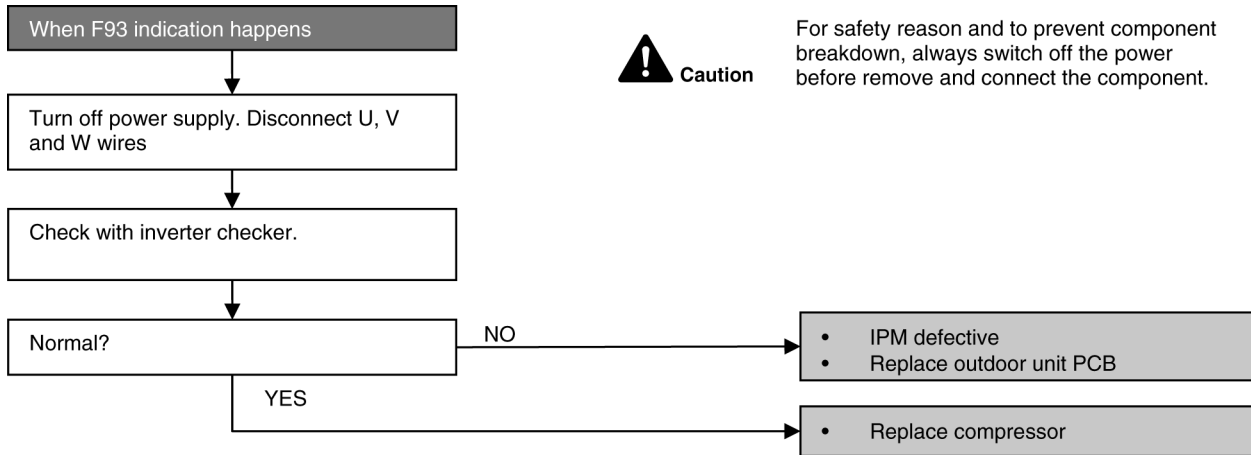

15.4.21. F95 (Cooling High Pressure Abnormality)

Malfunction Decision Conditions

During operation of cooling, when outdoor unit heat exchanger high temperature data (61°C) is detected by the outdoor pipe temperature sensor.

Malfunction Caused

- Outdoor pipe temperature rise due to short circuit of hot discharge air flow.
- Outdoor pipe temperature rise due to defective of outdoor fan motor.
- Outdoor pipe temperature rise due to defective outdoor pipe temperature sensor.
- Outdoor pipe temperature rise due to defective outdoor unit PCB.

Troubleshooting

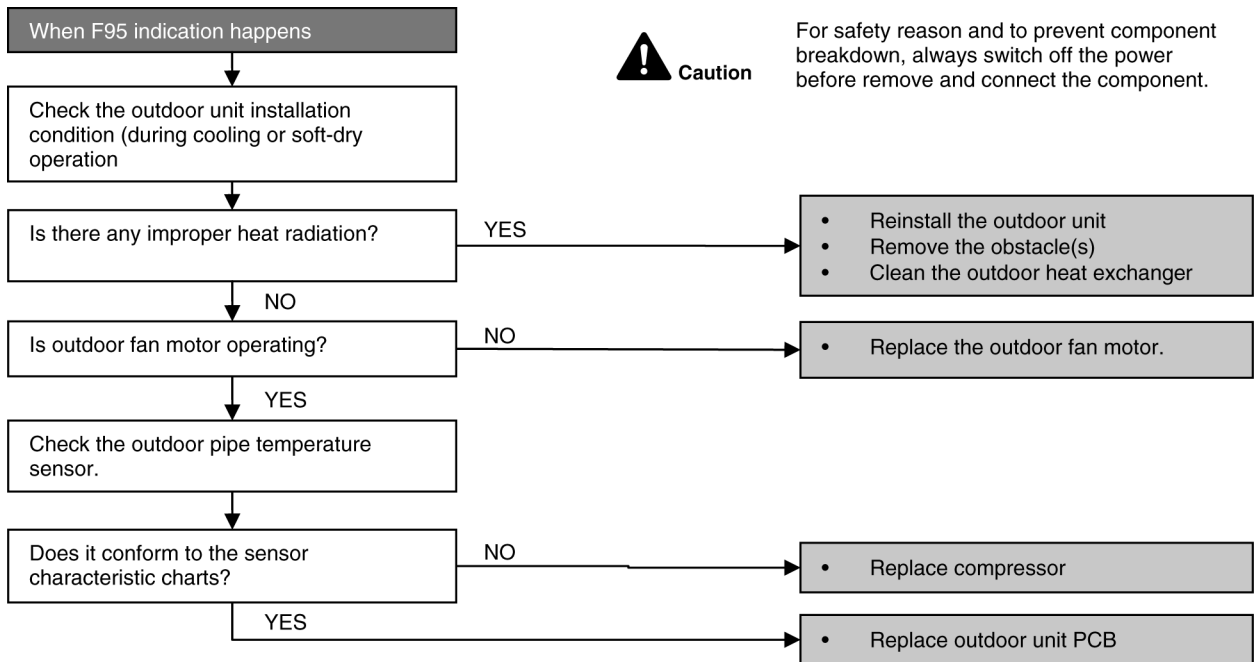

Caution

For safety reason and to prevent component breakdown, always switch off the power before remove and connect the component.

15.4.22. F96 (IPM Overheating)

Malfunction Decision Conditions

During operating of cooling and heating, when IPM temperature data (100°C) is detected by the IPM temperature sensor.

Multi Models Only

- Compressor Overheating: During operation of cooling and heating, when the compressor OL is activated.
- Heat Sink Overheating: During operation of cooling and heating, when heat sink temperature data (90°C) is detected by the heat sink temperature sensor.

Malfunction Caused

- IPM overheats due to short circuit of hot discharge air flow.
- IPM overheats due to defective of outdoor fan motor.
- IPM overheats due to defective of internal circuitry of IPM.
- IPM overheats due to defective IPM temperature sensor.

Multi Models Only

- Compressor OL connector poor contact.
- Compressor OL faulty.

Troubleshooting

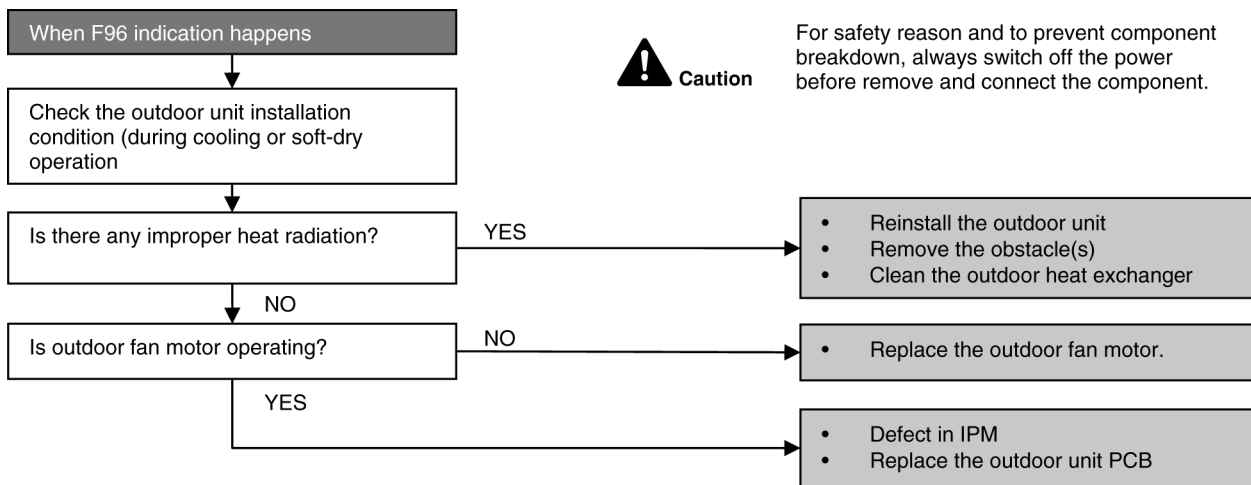

15.4.23. F97 (Compressor Overheating)

Malfunction Decision Conditions

During operation of cooling and heating, when compressor tank temperature data (112°C) is detected by the compressor tank temperature sensor.

Malfunction Caused

- Refrigerant shortage (refrigerant leakage).
- 2/3 way valve closed.
- Detection error due to faulty compressor tank temperature sensor.

Troubleshooting

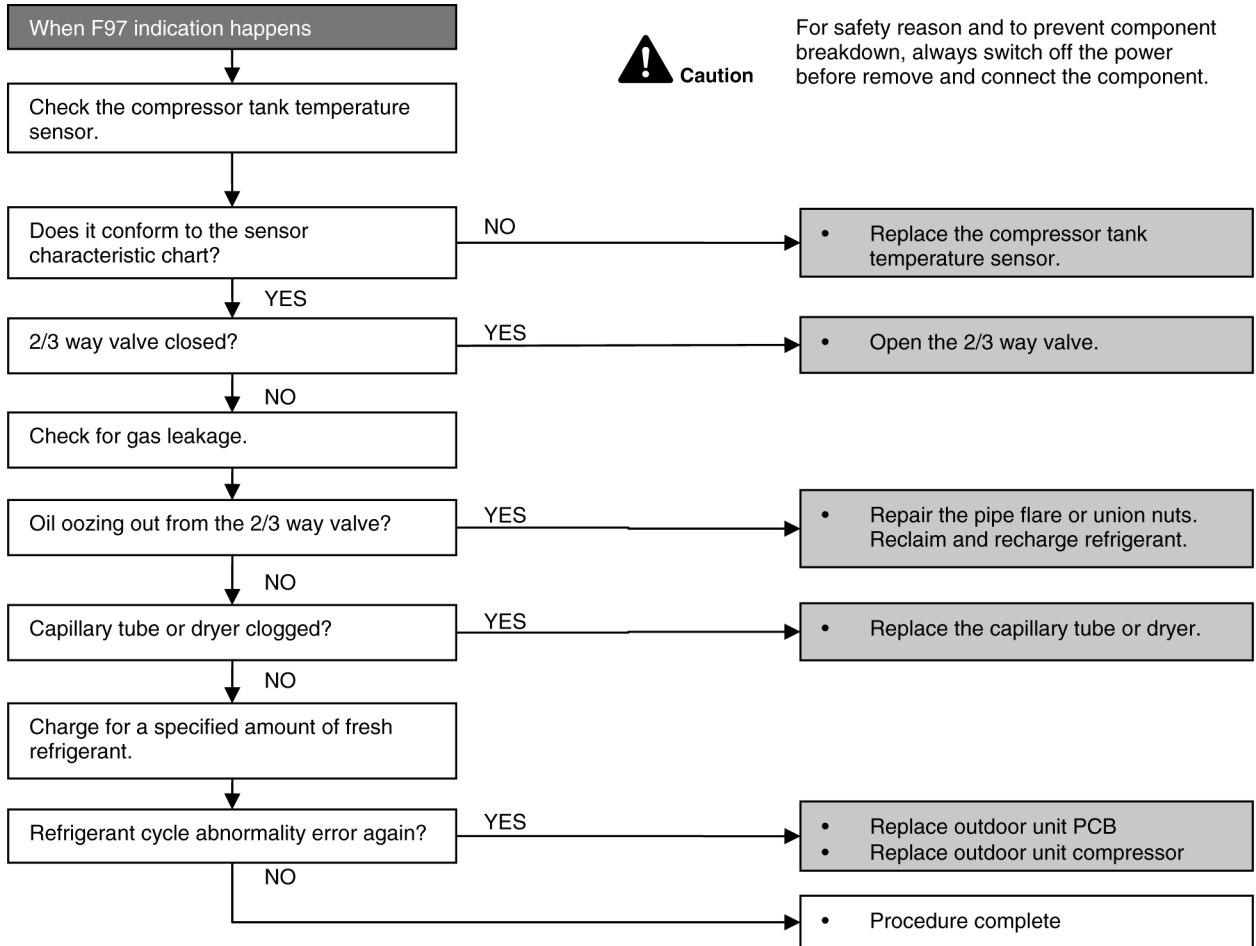

15.4.24. F98 (Input Over Current Detection)

Malfunction Decision Conditions

During operation of cooling and heating, when an input over-current (16.8A) is detected by checking the input current value being detected by current transformer (CT) with the compressor running.

Malfunction Caused

- Over-current due to compressor failure.
- Over-current due to defective outdoor unit PCB.
- Over-current due to defective inverter main circuit electrolytic capacitor.
- Over-current due to excessive refrigerant.

Troubleshooting

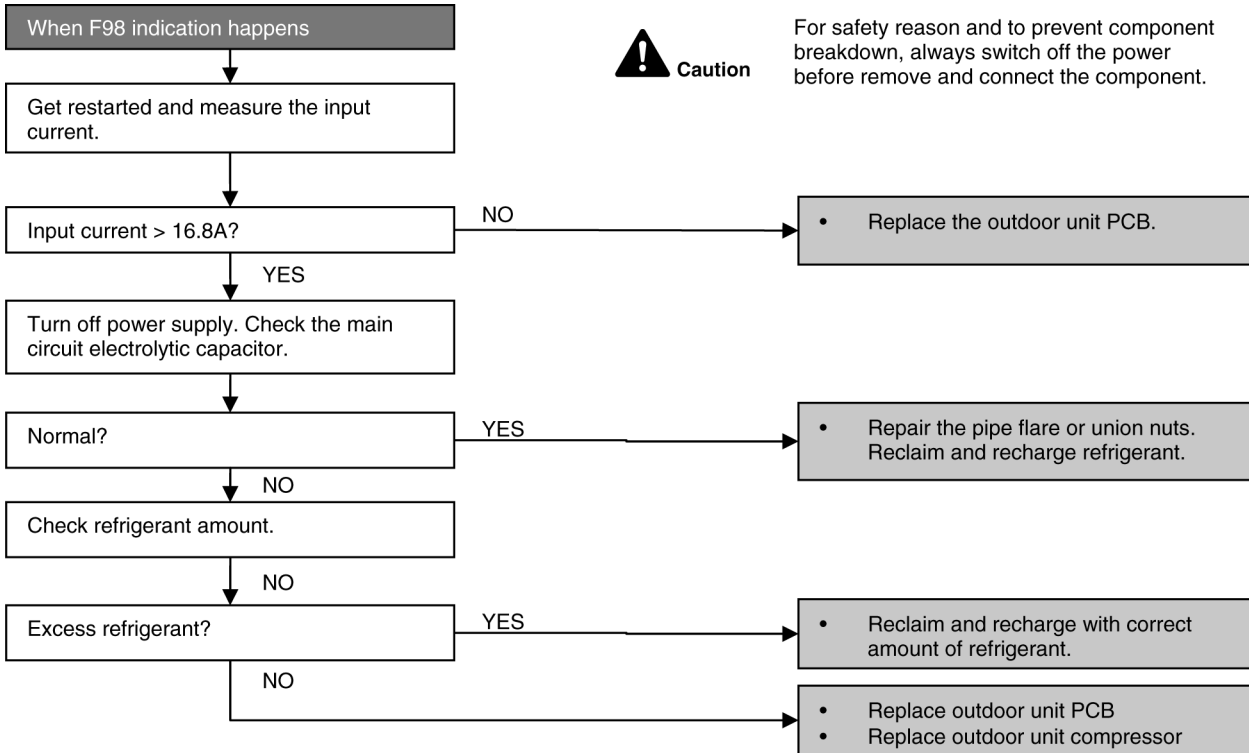

15.4.25. F99 (Output Over Current Detection)

Malfunction Decision Conditions

During operation of cooling and heating, when an output over-current (18.5A) is detected by checking the current that flows in the inverter DC peak sensing circuitry.

Malfunction Caused

- DC peak due to compressor failure.
- DC peak due to defective power transistor(s).
- DC peak due to defective outdoor unit PCB.

Troubleshooting

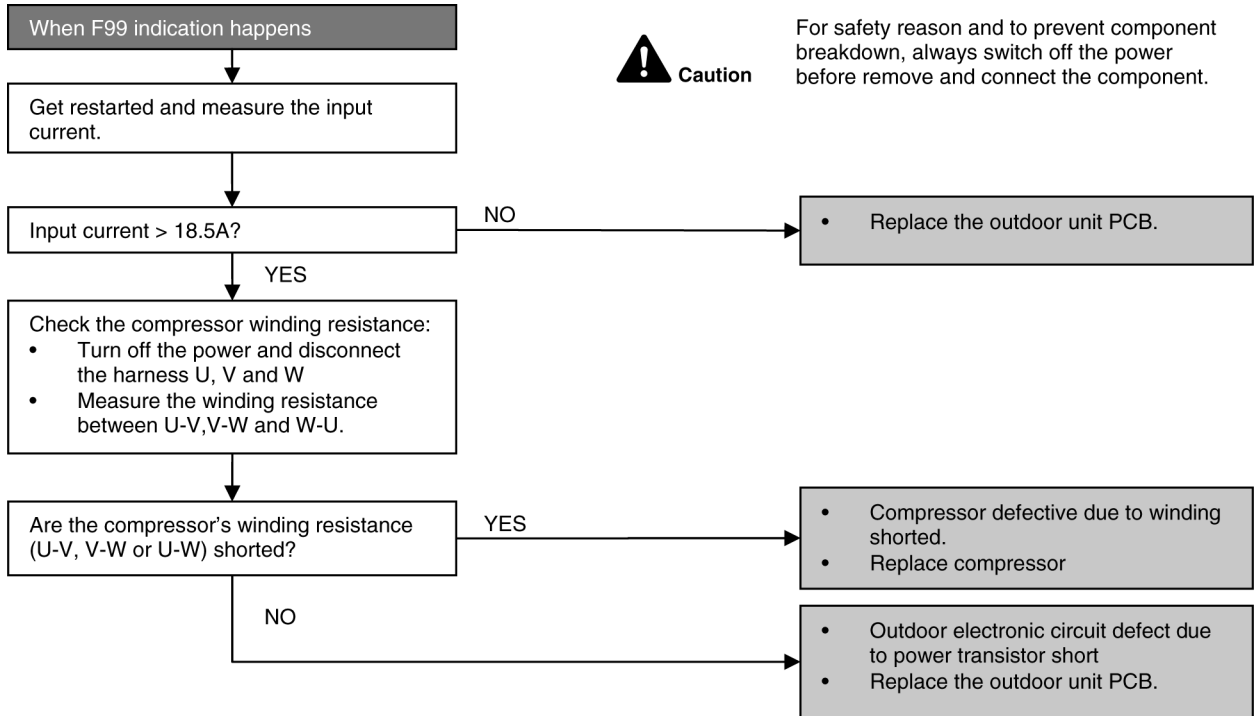

- Checking the power transistor
- Never touch any live parts for at least 10 minutes after turning off the circuit breaker.
- If unavoidable necessary to touch a live part, make sure the power transistor's supply voltage is below 50V using the tester.
- For the UVW, make measurement at the Faston terminal on the board of the relay connector.

Tester's negative terminal	Power transistor (+)	UVW	Power transistor (-)	UVW
Tester's positive terminal	UVW	Power transistor (+)	UVW	Power transistor (-)
Normal resistance	Several kΩ to several MΩ			
Abnormal resistance	0 or ∞			

16 Disassembly and Assembly Instructions

WARNING

High voltages are generated in the electrical parts area by the capacitor. Ensure that the capacitor has discharged sufficiently before proceeding with repair work. Failure to heed this caution may result in electric shocks.

16.1. Indoor Electronic Controller, Cross Flow Fan and Indoor Fan Motor Removal Procedure

16.1.1. To remove front grille

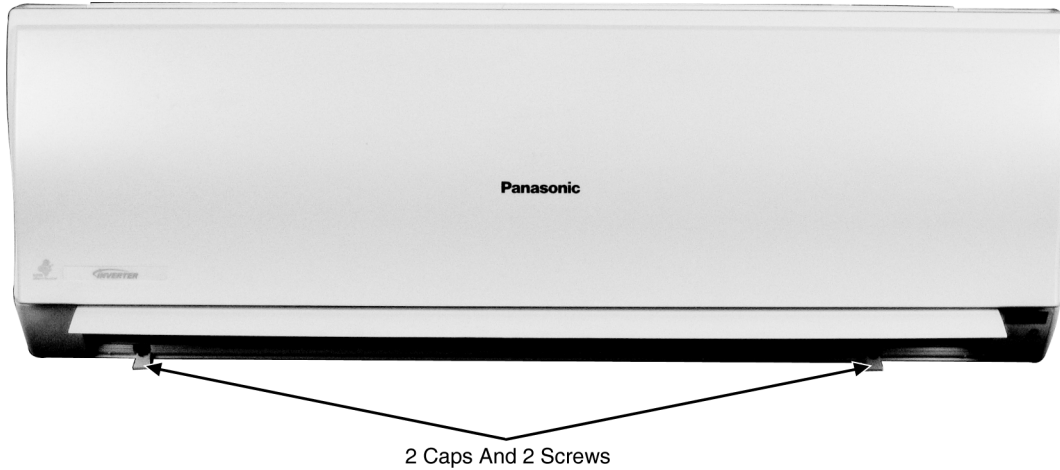

Fig. 1

1. Lift to open the horizontal vane gently. Remove the 2 caps and 2 screws at the bottom of discharge vane. (Fig.1)



Fig. 2

2. Remove the front panel by pressing Lever Arm with finger. (Fig.2)

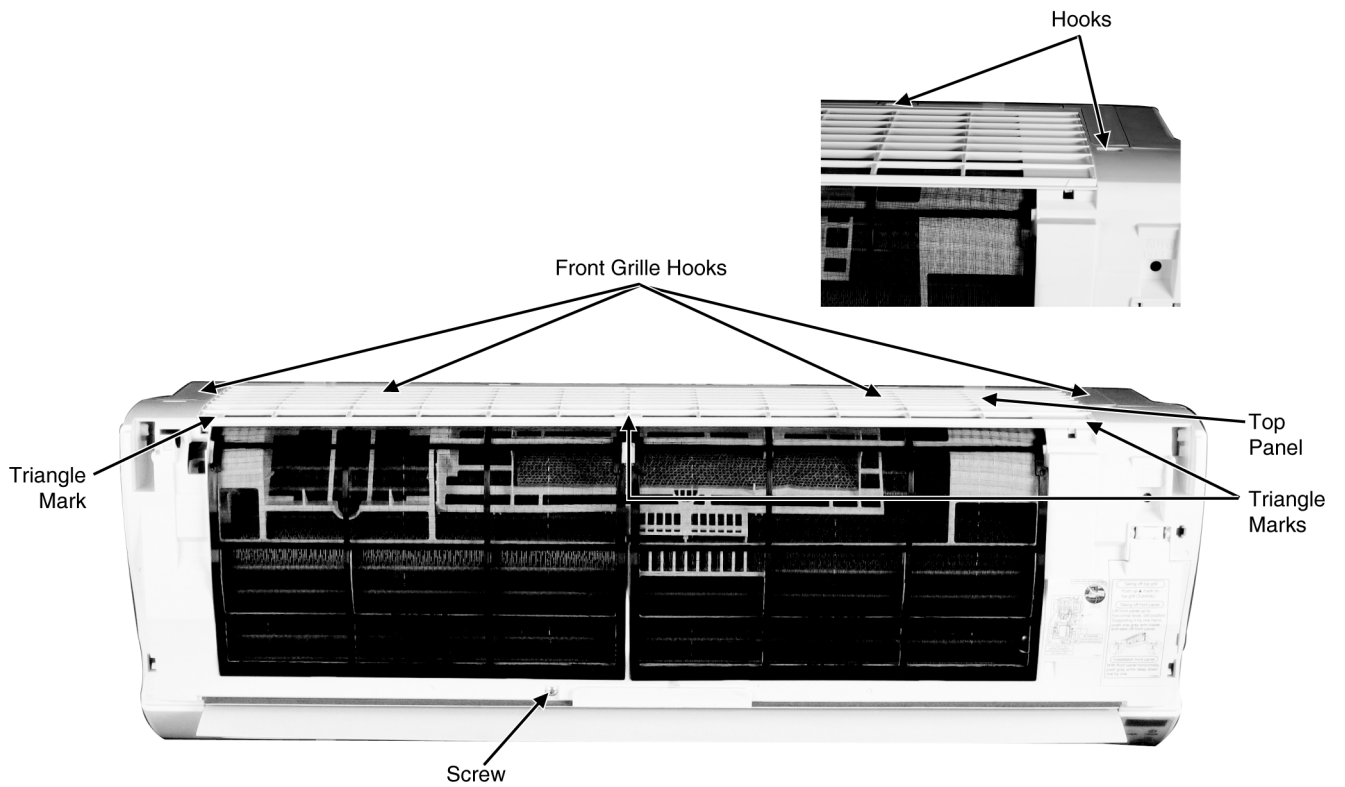

Fig. 3

3. Remove the Top Panel by pressing the triangle marks. (Fig.3)
4. Remove the screw (one) in center part of the unit. (Fig.3)
5. Remove the Front Grille by releasing the 4 hooks at the top of the Front Grille. Hold both side of the Front Grille and remove it by pulling up and toward you gently. (Fig.3)

16.1.2. Removal of Control Board Complete

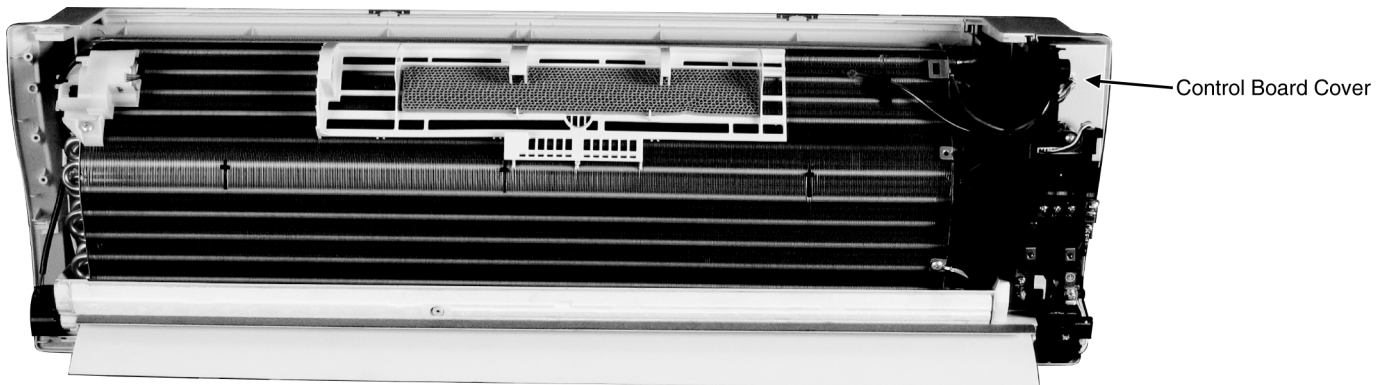

Fig. 4

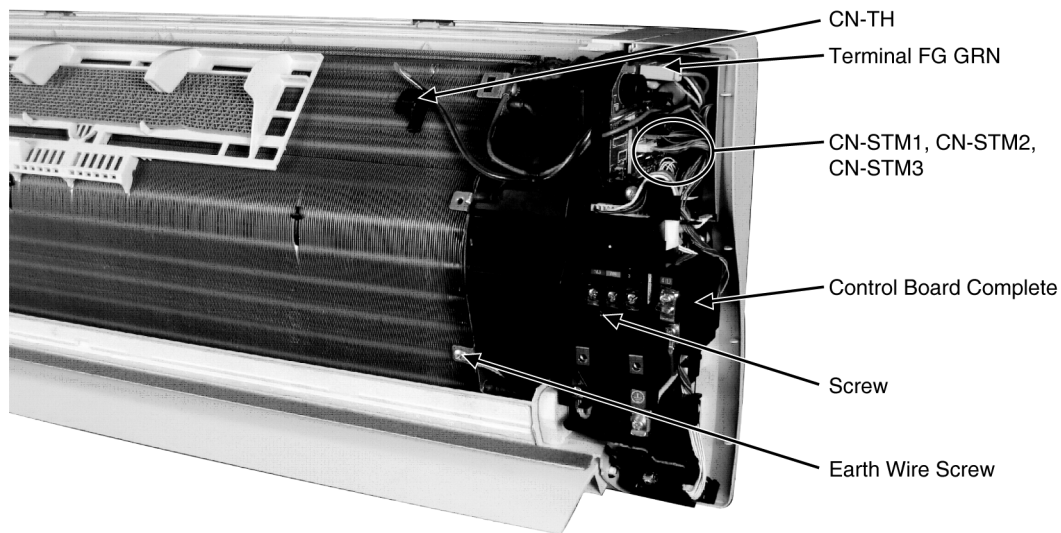

Fig. 5

1. Remove the Control board cover. (Fig.4)
2. Remove the screw at the control board then pull out the control board. (Fig.5)
3. Release CN-TH from evaporator. (Fig.5)
4. Release earth wire screw from the evaporator. (Fig.5)
5. Disconnect below connectors from PCB. (Fig.5)
 - Terminal FG GRN.
 - CN-STM1 - Air Swing Motor for vertical louver.
 - CN-STM2 - Air Swing Motor for horizontal louver.
 - CN-FM - Indoor Unit Fan Motor.

16.1.3. Removal of PCB

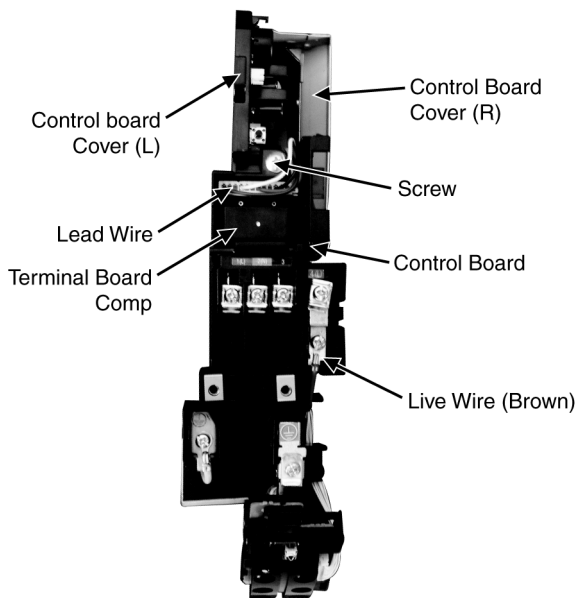

Fig. 6

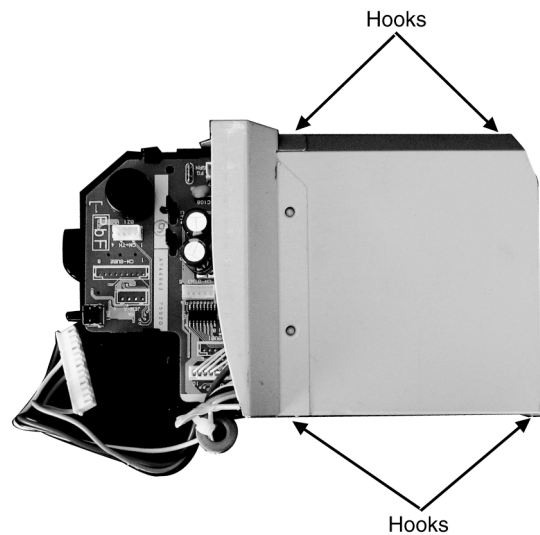

Fig. 7

1. Disconnect lead wire from terminal board complete. (Fig.6)
2. Disconnect live wire (brown) from terminal plate connector. (Fig.6)
3. Release screw from the control board. (Fig.6)
4. Remove control board cover (L) and control board cover (R) from the control board. (Fig.6)
5. Remove control board cover (R) from control board cover (L) by releasing the hooks. (Fig.7)

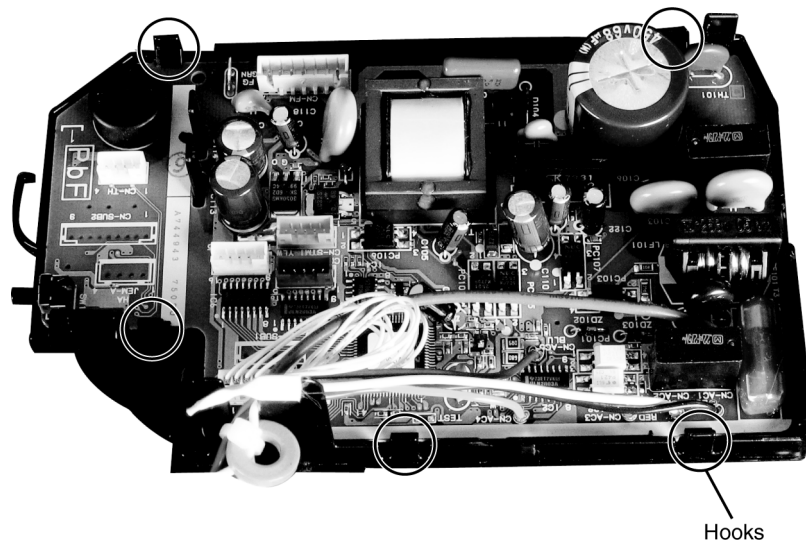

Fig. 8

6. Remove the control boards cover (L) by releasing the hooks then remove the PCB from the control board cover (L). (Fig.8)

16.1.4. Removal of Fan Motor and Cross-Flow Fan

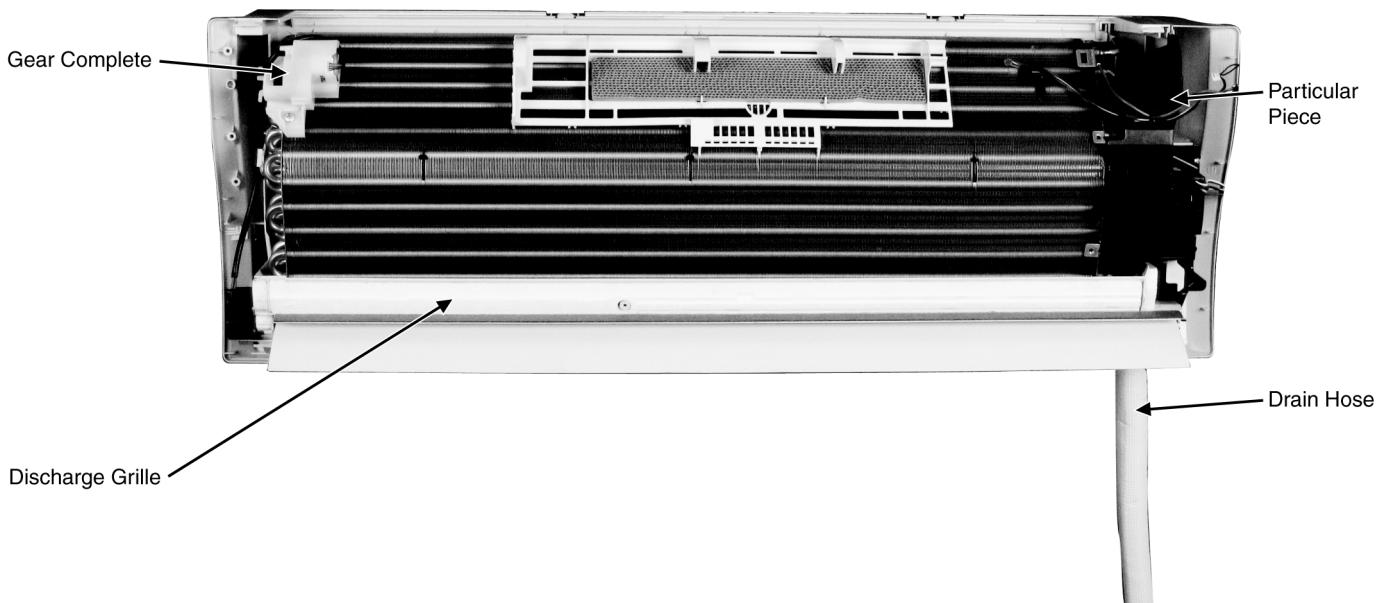

Fig. 9

1. Remove particular piece. (Fig.9)
2. Remove the drain hose from the unit. (Fig.9)

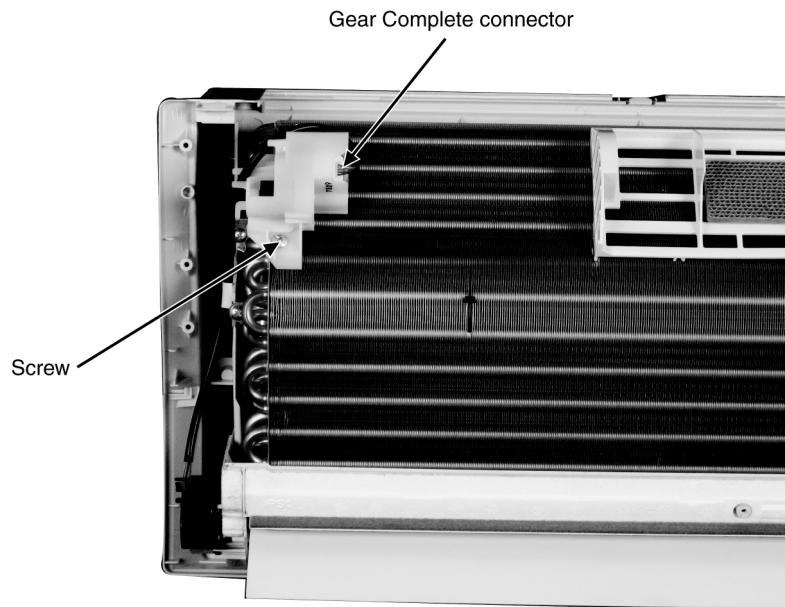

Fig. 10

3. Remove connector at the Gear Complete. (Fig.10)
4. Release screw at Gear Complete then remove the Gear Complete. (Fig.10)
5. Pull the Discharge Grille downward then removed it. (Fig.9)

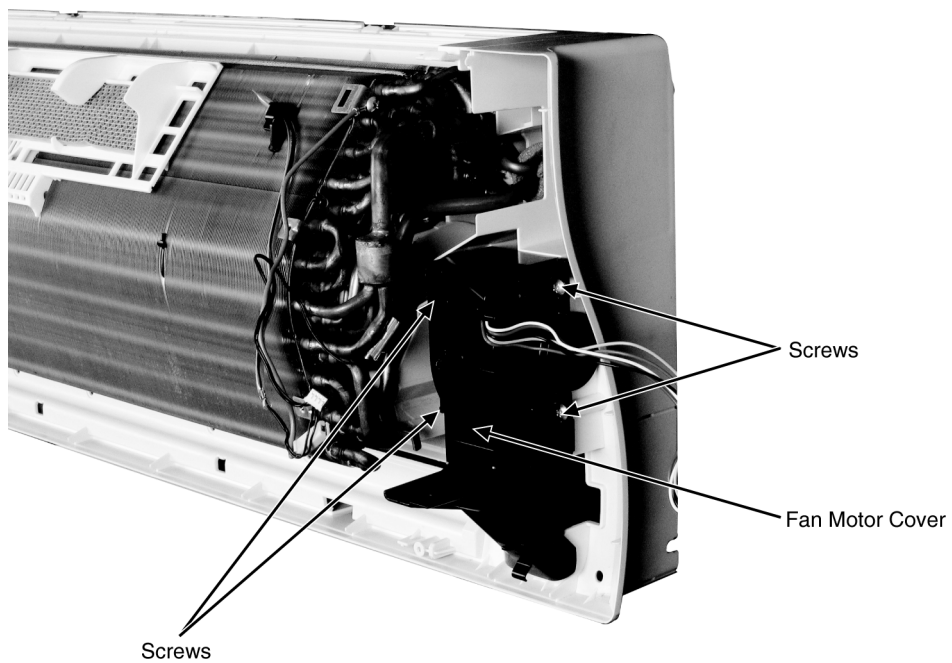

Fig. 11

6. Remove the Fan Motor Cover by removing four screws from the Fan Motor Cover. (Fig.11)

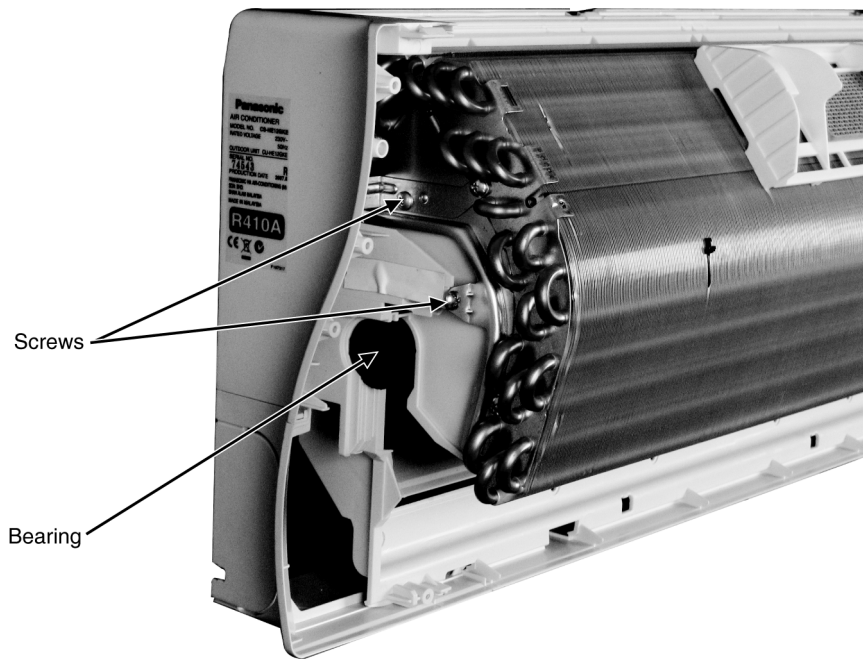

Fig. 12

7. Remove the screw on the left side of evaporator. (Fig.12)

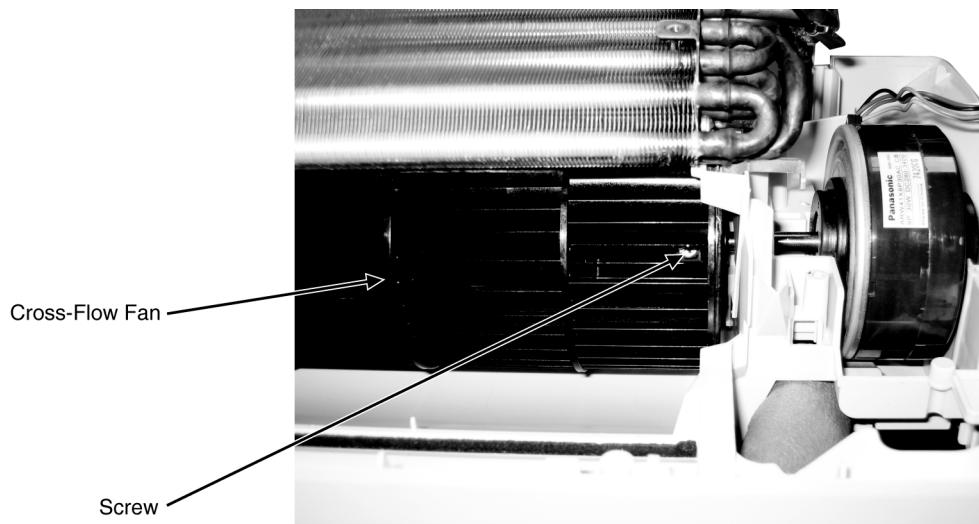

Fig. 13

8. Loosen the screw between the Cross-Flow Fan and Fan Motor. (Fig.13)

9. Remove the bearing. (Fig.12)



Fig. 14

10. Lift up the Evaporator and remove the Cross-Flow Fan from the unit by pulling it to the left and downward. (Fig. 14)

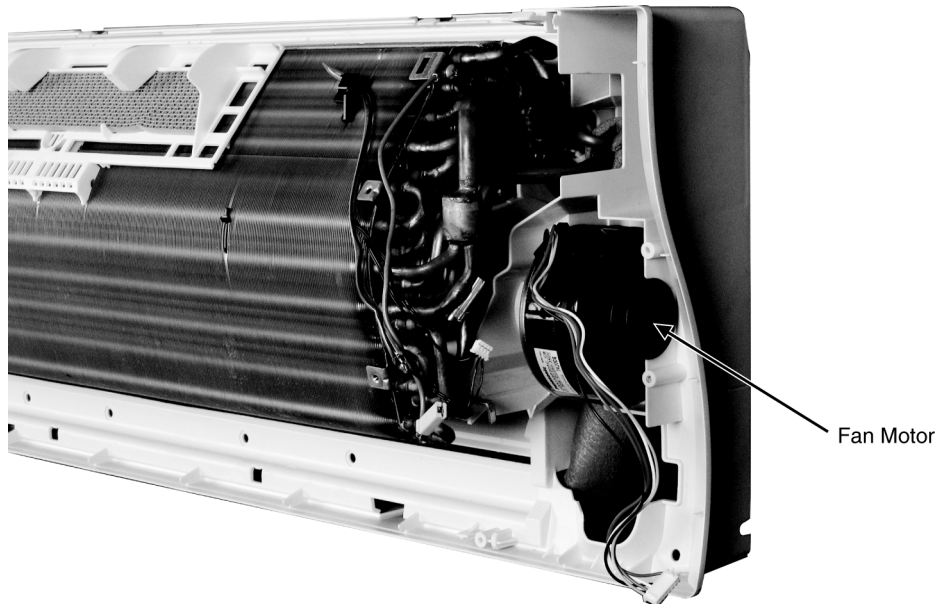

Fig. 15

11. Pull out the Fan Motor. (Fig.15)

16.1.5. Removal of Terminal Board Complete

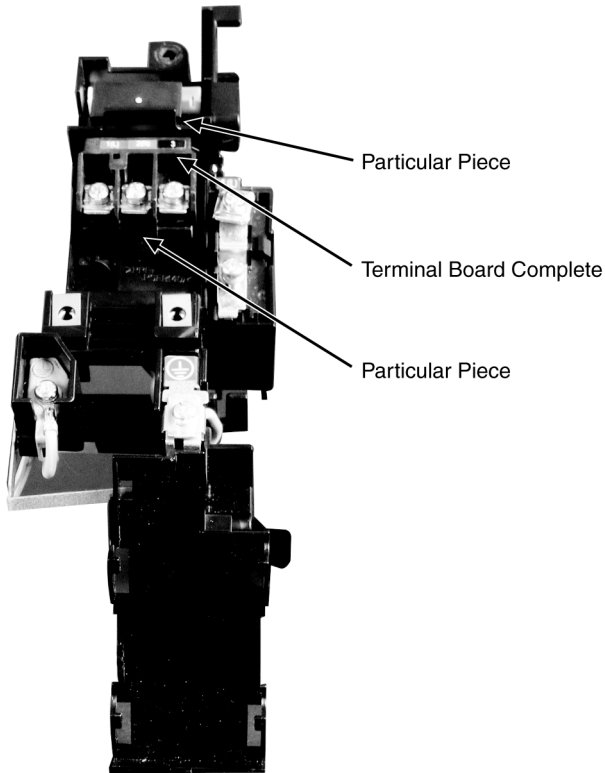

Fig. 16

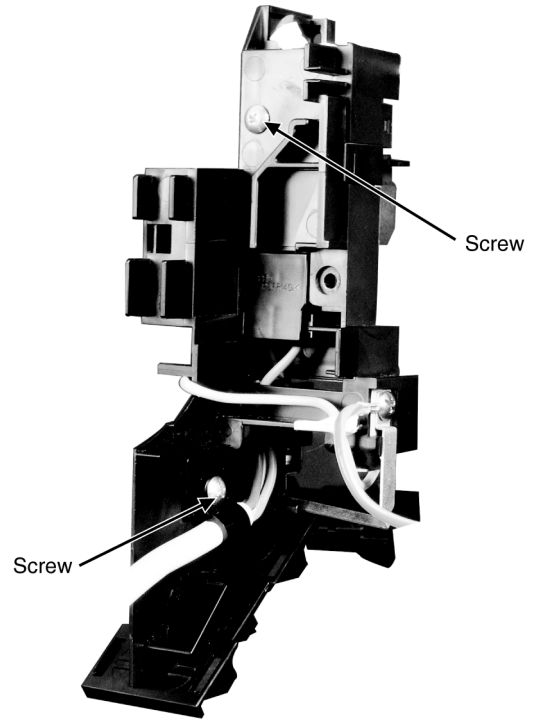
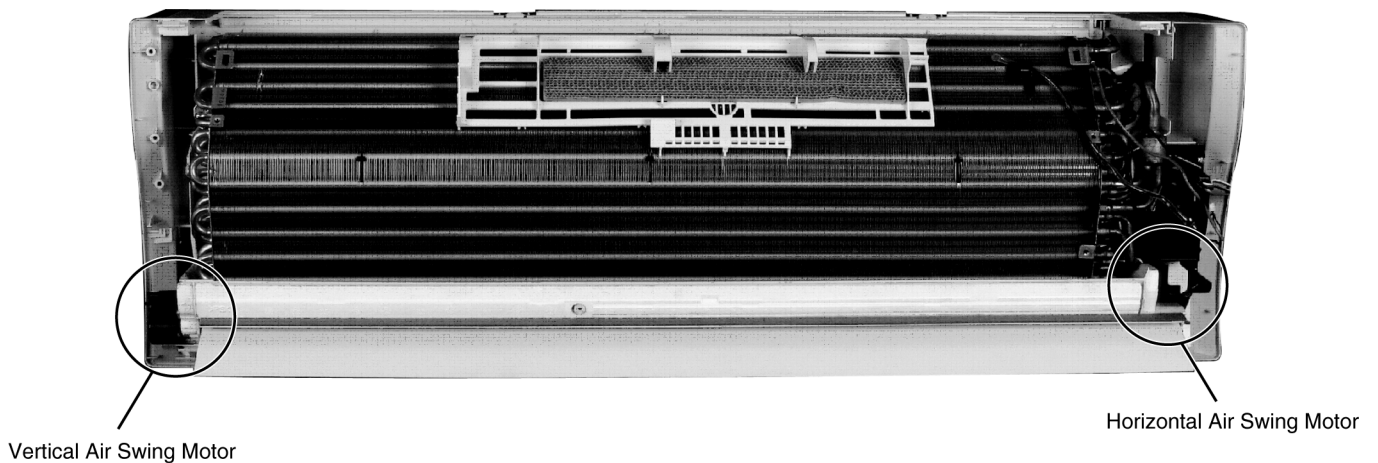

Fig. 17

1. Detach the Power supply cord screw. (Fig.17)
2. Remove screw at Terminal Board Complete. (Fig.17)
3. Remove two particular pieces, the Terminal Board Complete. (Fig.16)
4. Removed live (brown) and neutral (blue) wire. (Fig.17)

16.1.6. Removal of Air Swing Motors for Vertical and Horizontal Louvers.

1. The Air Swing Motors for Vertical and Horizontal louvers can be removed without removal of Discharge Grille.



2. Remove the screws from the motors and then remove the cable connectors. (Fig.18)

16.2. Disassembly of Outdoor Unit

⚠ WARNING

Electric parts in Outdoor Unit (Control Cover inside) contain High Voltage by booster capacitor. Make sure to discharge it completely before servicing in order to prevent electric shock.

16.2.1. Removal of Cabinet Top Plate and Cabinet Front Plate

1. Remove the screws (three: two on the right side and one on the left side) and the Cabinet Top Plate.
2. Remove the screws (six: three on the upper side and another three on the lower side) on the Cabinet Front Plate.

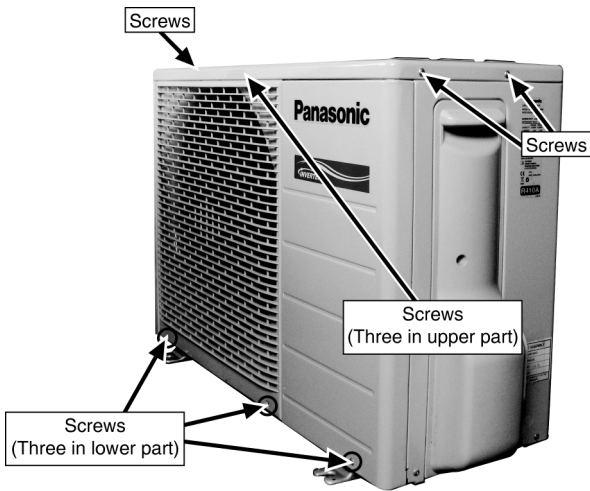

Fig. 1

3. Release the hooks (four: two on the right and another two on the left) of the Cabinet Front Plate and remove the Front Plate by holding it up a little.



Fig. 2

16.2.2. Removal of Control Cover and Terminal Cover

1. Remove the screw (one) on the Control Cover and remove it by sliding it downward.



Fig. 3

2. Remove the Terminal Cover by removing the screws (two) and releasing the hooks (two).

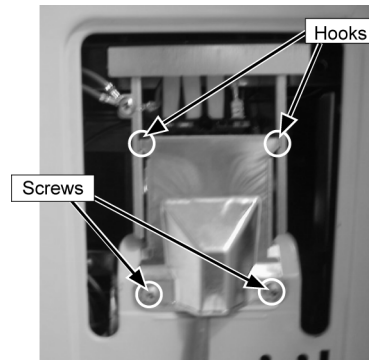

Fig. 4

16.2.3. Removal of Control Box

1. Remove the Control Board by releasing the hooks (four: two each on the right and left).

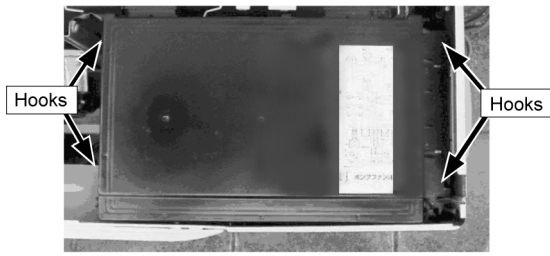

Fig. 5

2. Remove the screw (one) fixing the Control Box.

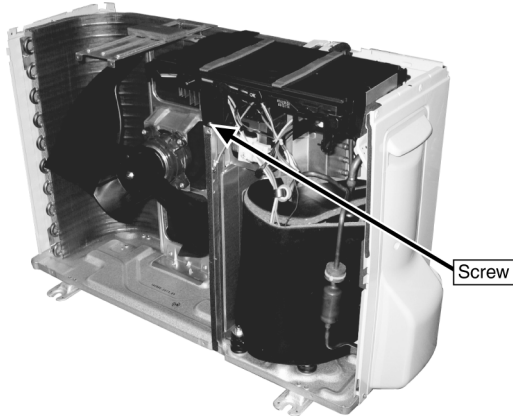

Fig. 6

3. Remove a variety of connectors and Terminals.

- Compressor cables (red, blue and yellow) Remove the Connector (white).
- CN-HOT 4-way Valve
- CN-FM1 Outdoor Fan Motor
- CN-STM Expansion Valve
- CN-TH Sensor Complete (Outdoor Air/Pipe Temp.)
- CN-DIS Sensor Complete (Discharge Air Temperature)
- Reactor Connectors (two)

4. Remove the interconnect cables and the Earth Wire (one screw).

- Interconnect cables (red, white and black) Disconnect them from the Terminals.
- The earth terminal (yellow-green) Remove it by unscrewing. (one screw)
- Remove the screws (two) fixing the Terminal part and the Cabinet Side Plate.

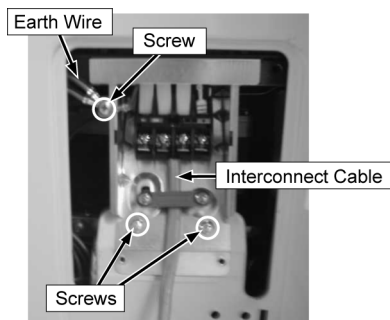

Fig. 7

5. Remove the Control Box from the unit by holding it up.

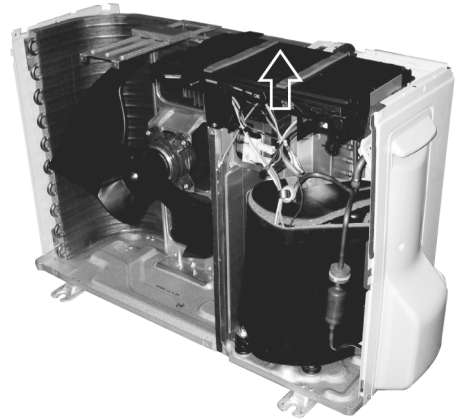

Fig. 8

16.2.4. Removal of Control Board

1. Remove the Cabinet Top Plate and Cabinet Front Plate according to 16.2.1.
2. Remove the Control Cover and Terminal Cover according to 16.2.2.
3. Remove the Control Box according to 16.2.3.
4. Disconnect the Control Terminals (Four cables).

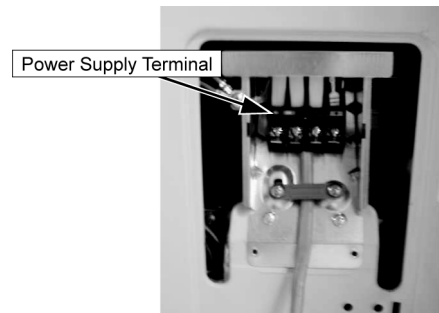

Fig. 9

5. Place the Control Box reversely and remove the screws (two) on the both sides of the Control Box B (for Terminal Plate).

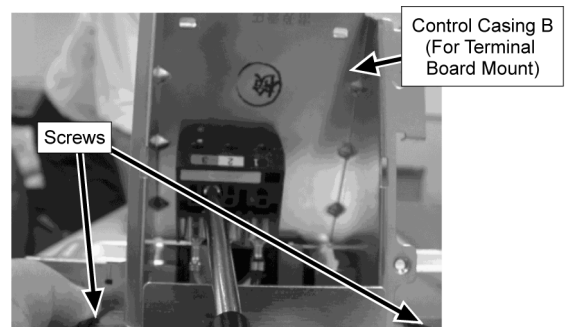

Fig. 10

- Release the hooks (four) on the Control Box A (Lower Control PCB Cover).

Note: Be careful of hanging-up of connectors or wiring cables such as the earth wire when the Box A is removed.

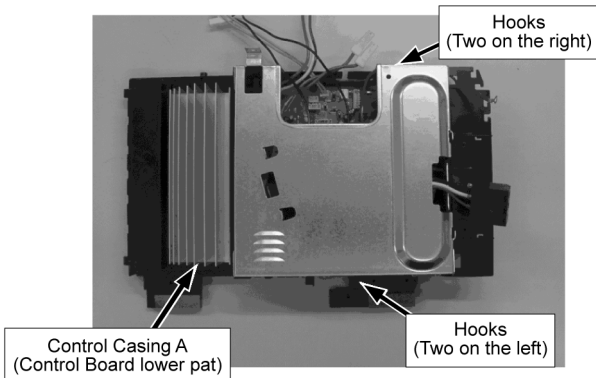

Fig. 11

- For the Control Board, replacement is made together with the Control Box.

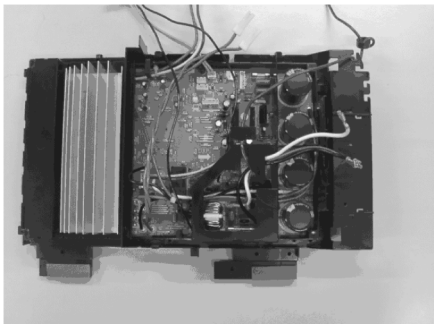

Fig. 12

• Replacement of the Outdoor Control PCB should be made as a whole unit due to silicon pasting, etc. although it can be separated PCB part from Control BOX plastic part by removing the screws (six) on the PCB.

16.2.5. Removal of Propeller Fan and Fan Motor

- Remove the Cabinet Top Plate and Cabinet Front Plate according to 16.2.1.
- Remove the Control Box by releasing the hooks (four: two each on the both sides).

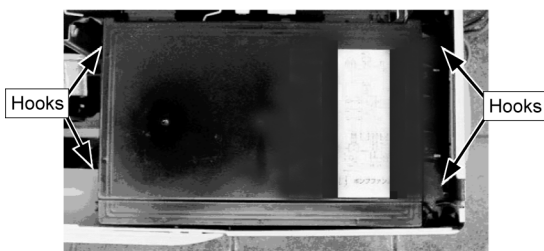

Fig. 13

- Remove only the Connector for the CN-FM1 (Outdoor unit Fan Motor).
- Remove the Propeller Fan by turning the nut in the center of the fan clockwise.

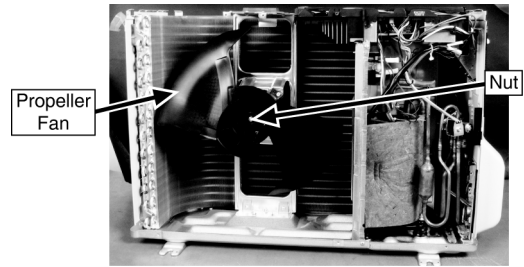

Fig. 14

- Remove the Fan Motor by loosening the screw (four).

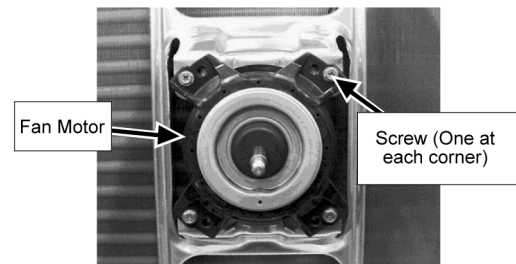

Fig. 15

Note: Adjust the location of the Boss in the center of the Propeller and the matching groove on the shaft of the Motor when putting them together.

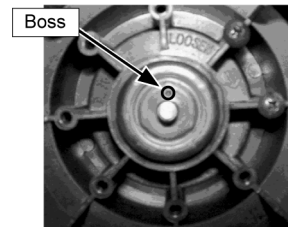

Fig. 16

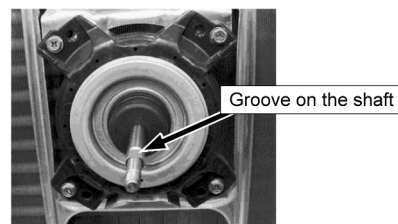

Fig. 17

17 Technical Data

17.1. Operation Characteristics

17.1.1. CS-HE9LKE CU-HE9LKE

• Cooling Characteristic

[Condition] Room temperature: 27/19°C
Operation condition: High fan speed
Piping length: 5.0m
Freq: Rated Fc

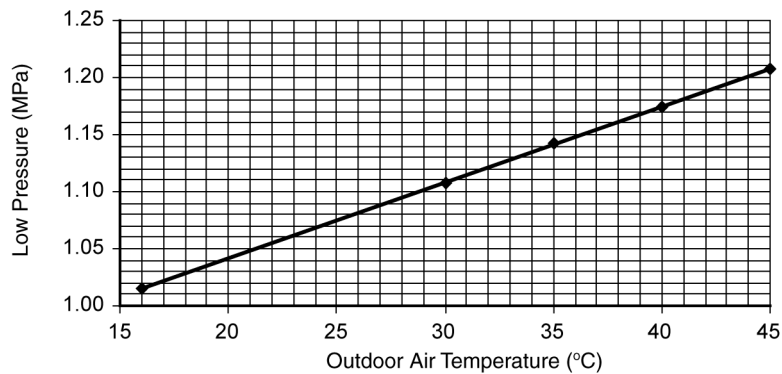
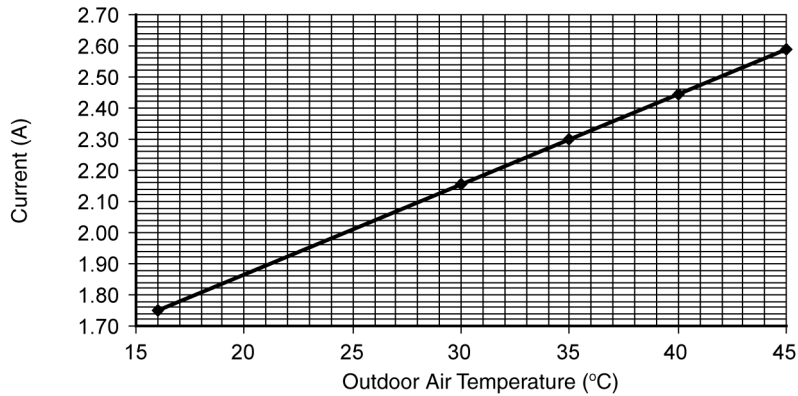
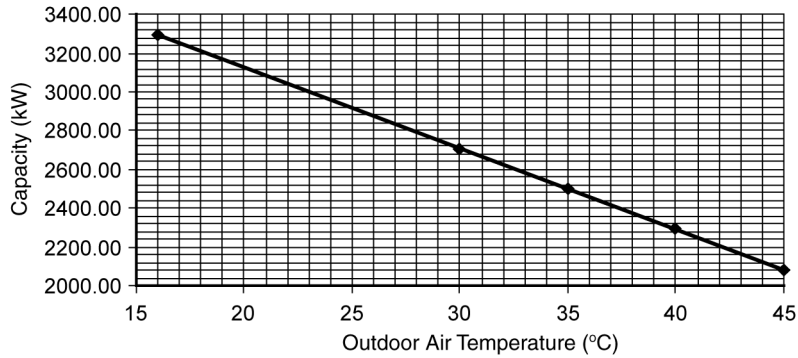
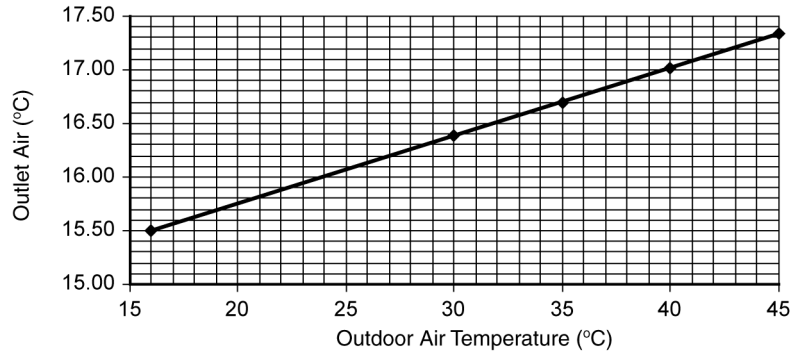

• Piping Length Characteristic

[Condition] Room temperature: 27/19°C
Operation condition: High fan speed
Outdoor temperature: 35/24°C
Freq: Rated Fc

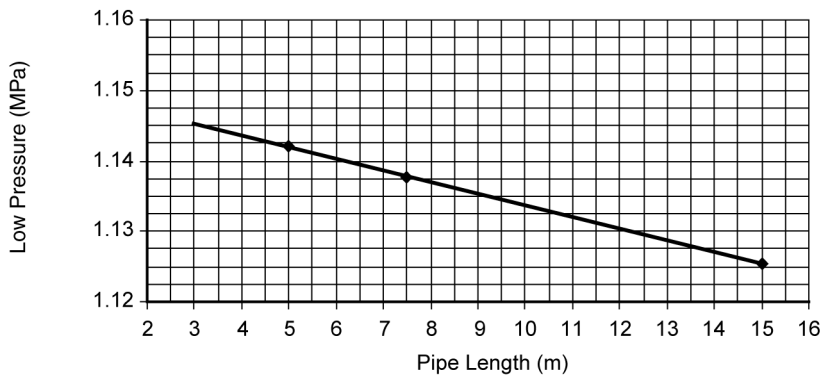
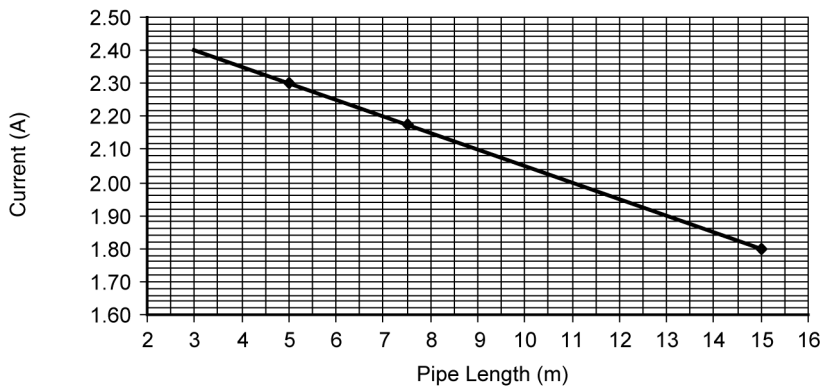
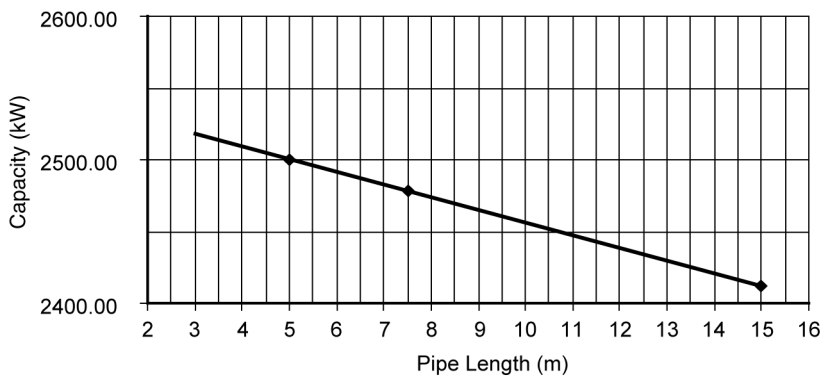
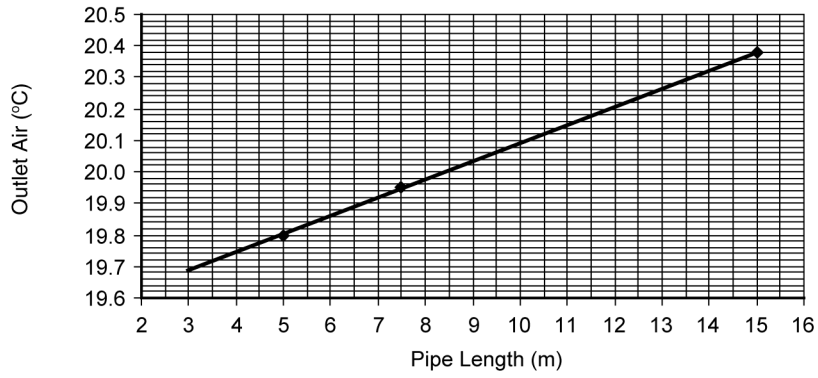

• Heating Characteristic

[Condition] Room temperature: 20°C
Operation condition: High fan speed
Piping length: 5.0 m
Freq: Rated Fh

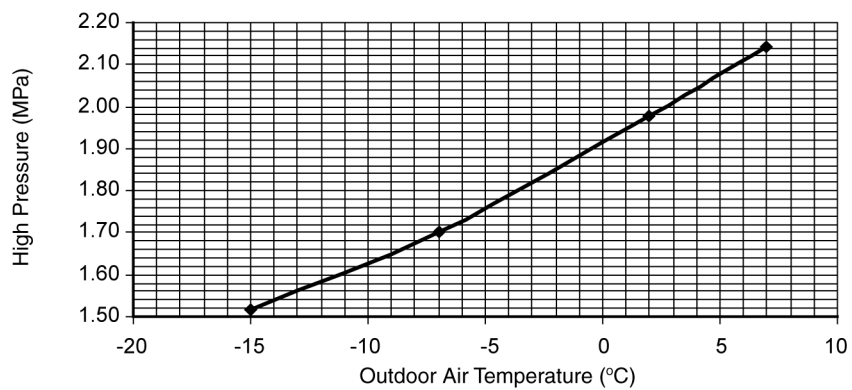
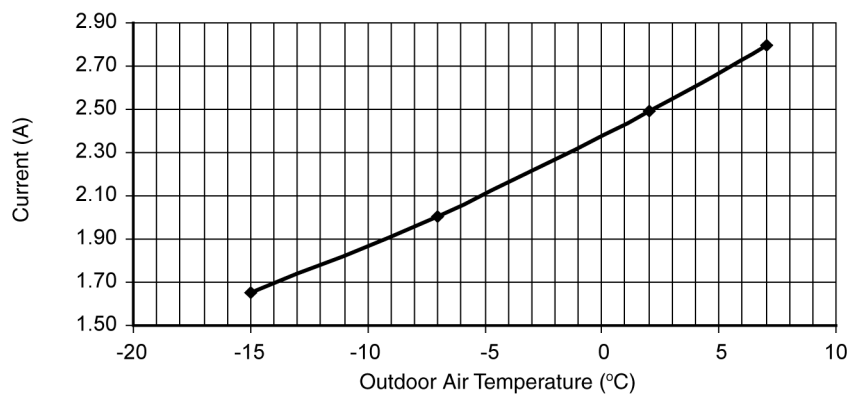
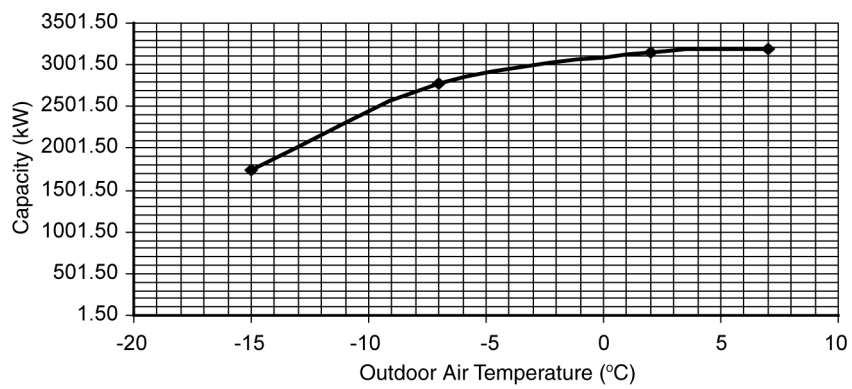
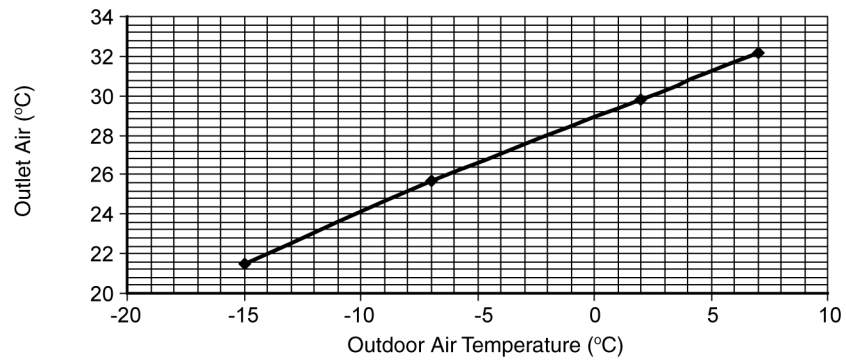

• Piping Length Characteristic

[Condition] Room temperature: 20°C
 Operation condition: High fan speed
 Outdoor temperature: 7/6°C
 Freq: Rated Fh

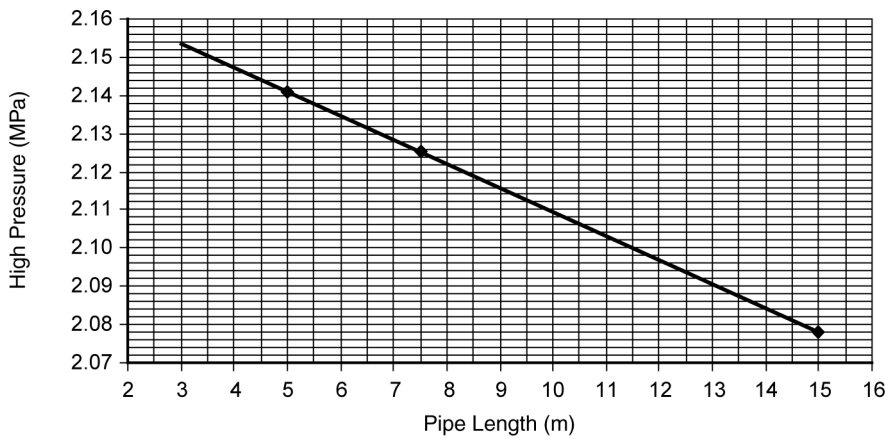
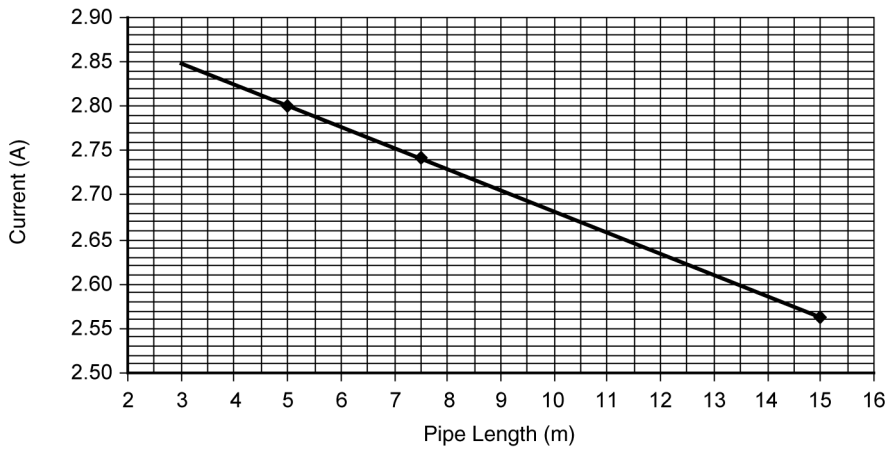
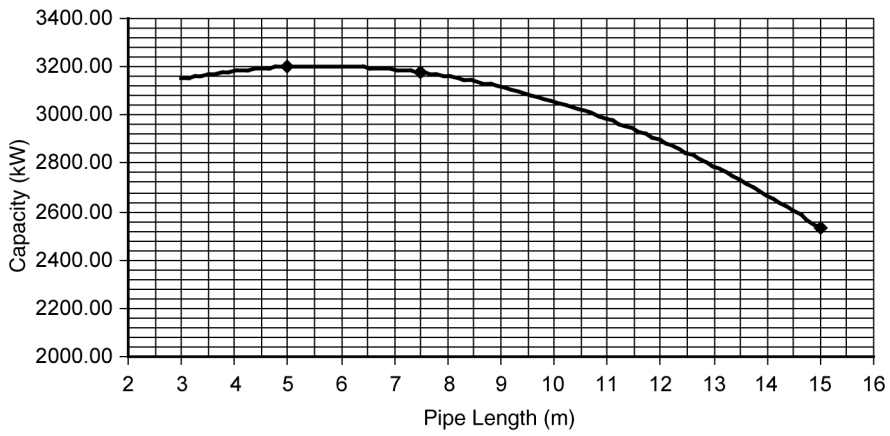
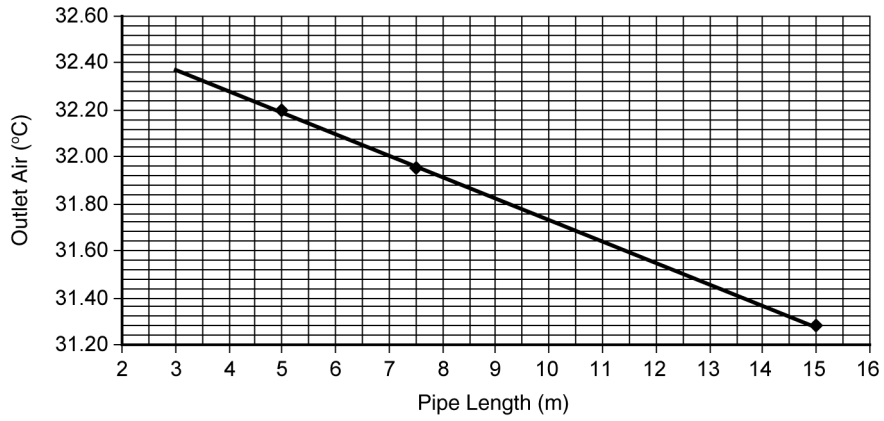

17.1.2. CS-HE12LKE CU-HE12LKE

• Cooling Characteristic

[Condition] Room temperature: 27/19°C
Operation condition: High fan speed
Piping length: 5.0m
Freq: Rated Fc

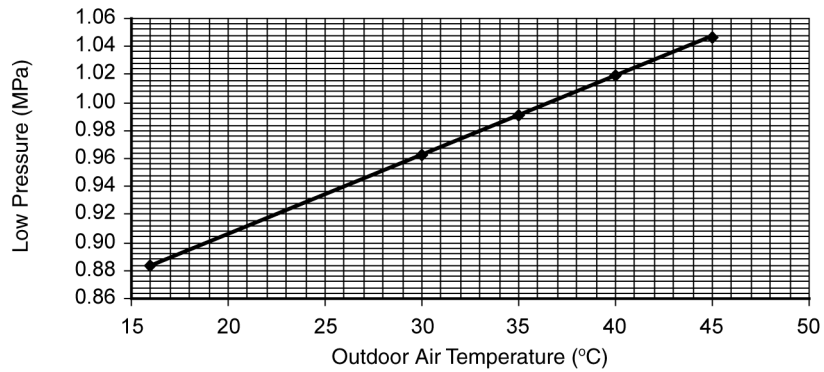
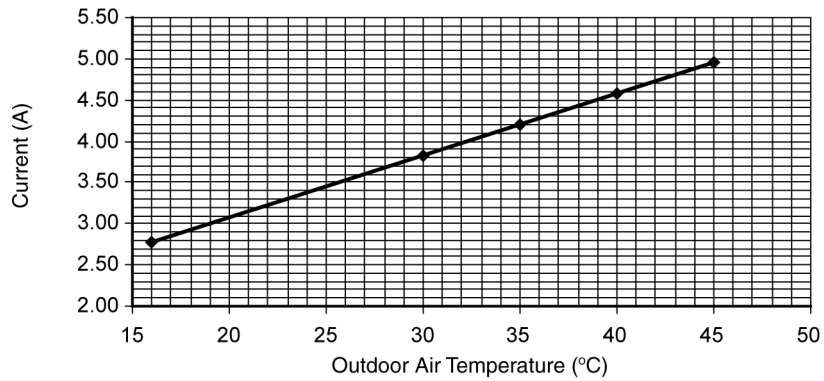
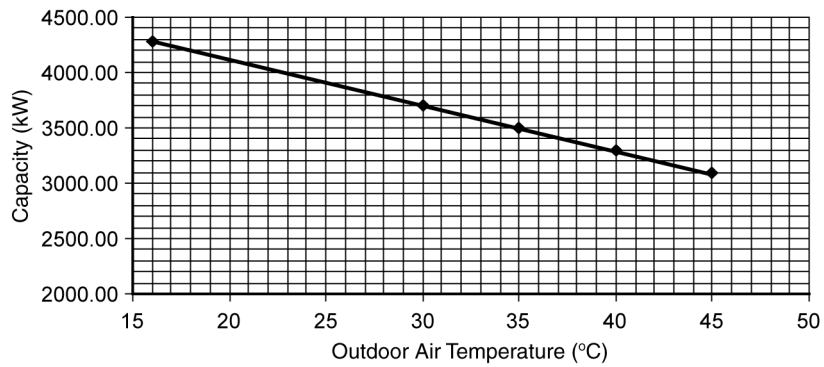
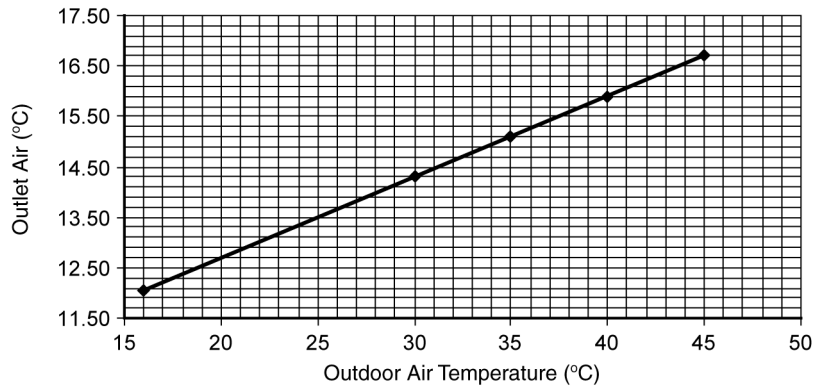

• Piping Length Characteristic

[Condition] Room temperature: 27/19°C
 Operation condition: High fan speed
 Outdoor temperature: 35/24°C
 Freq: Rated Fc

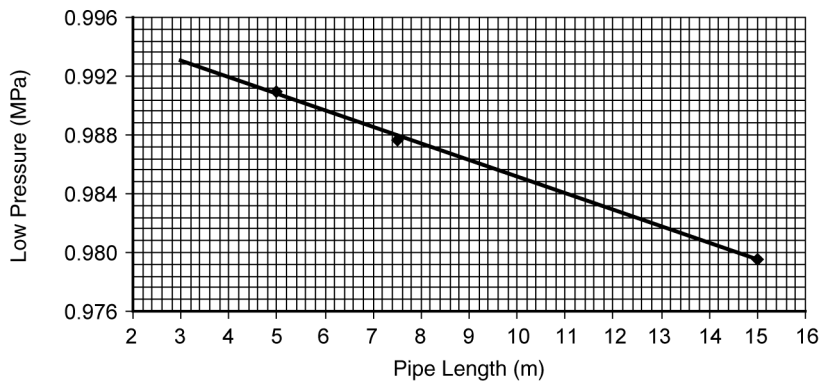
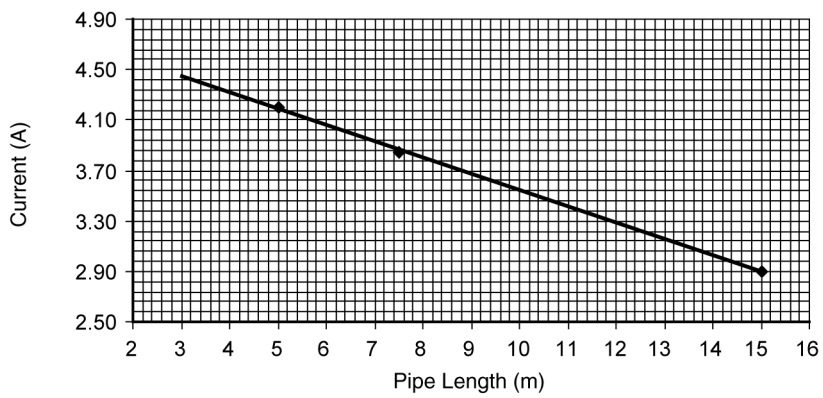
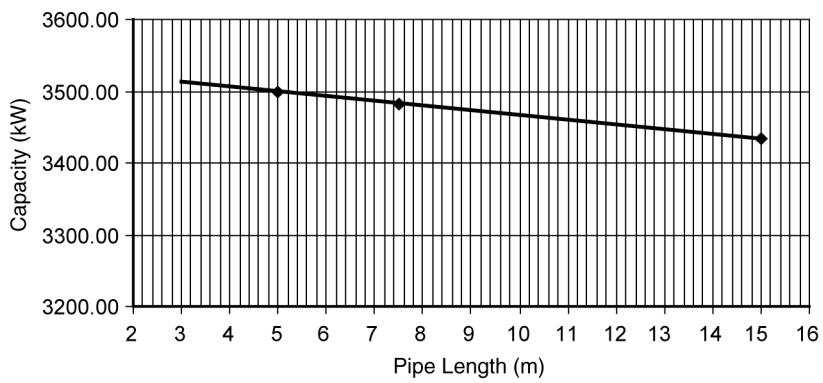
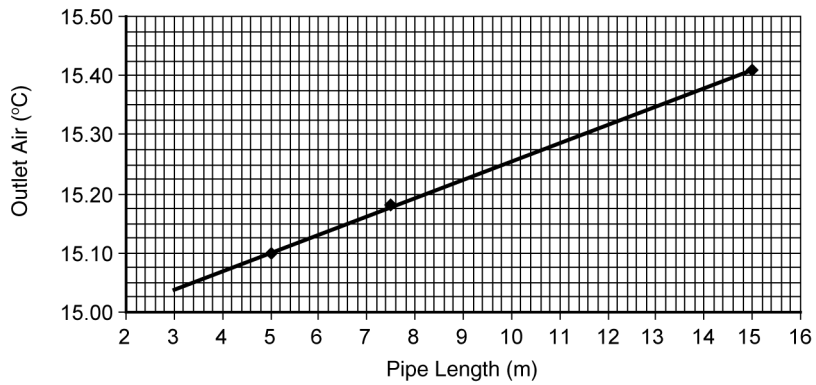

• Heating Characteristic

[Condition] Room temperature: 20°C
Operation condition: High fan speed
Piping length: 5.0m
Freq: Fh

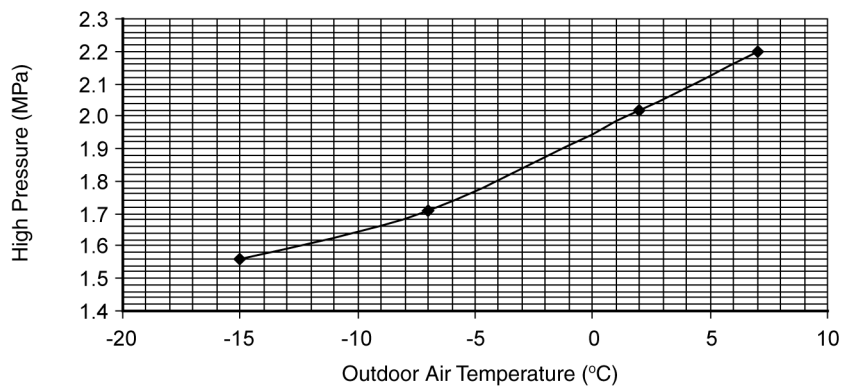
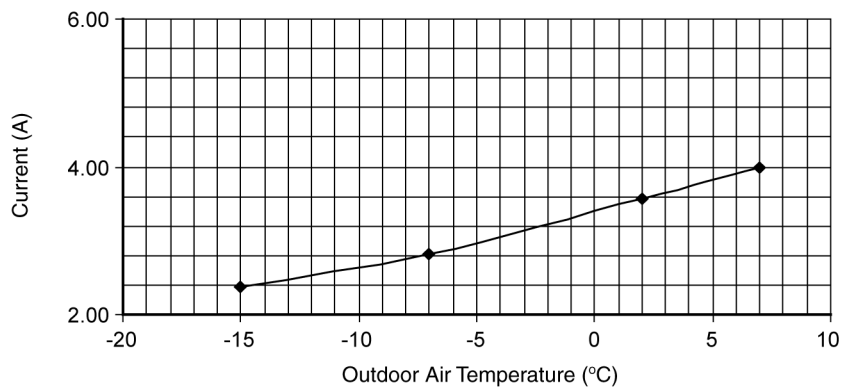
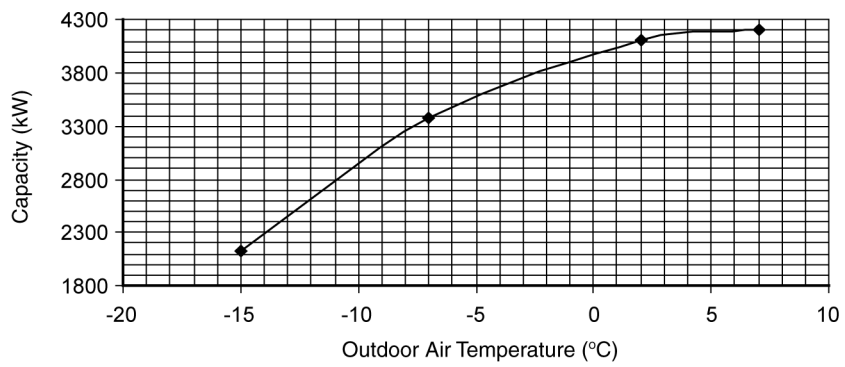
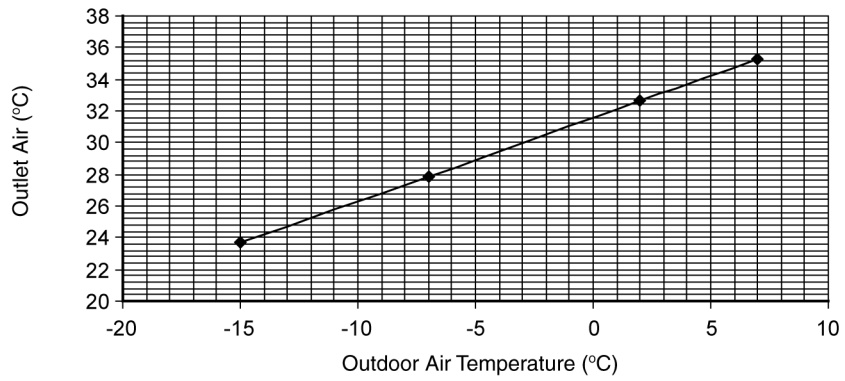

• Piping Length Characteristic

[Condition] Room temperature: 20°C
 Operation condition: High fan speed
 Outdoor temperature: 7/6°C
 Freq: Rated Fh

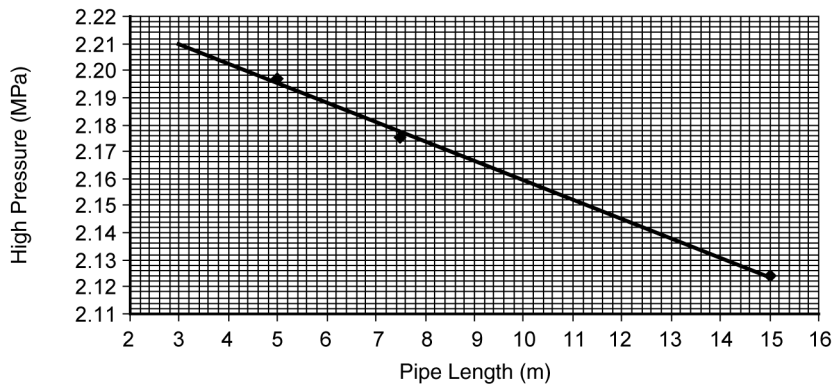
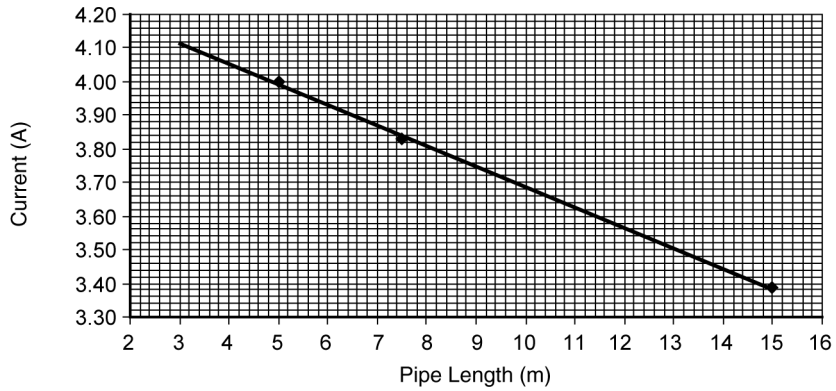
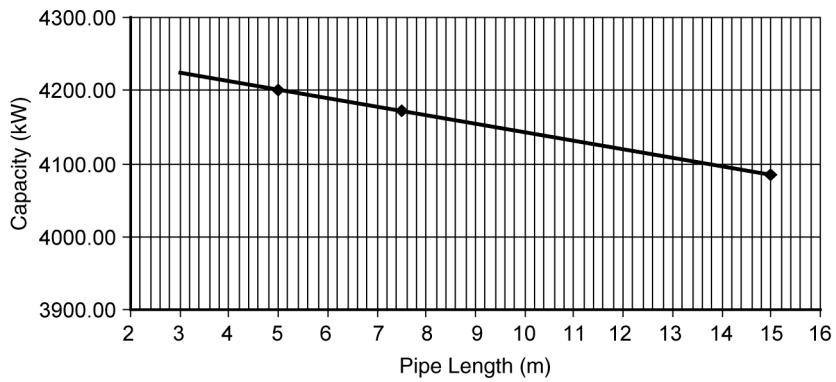
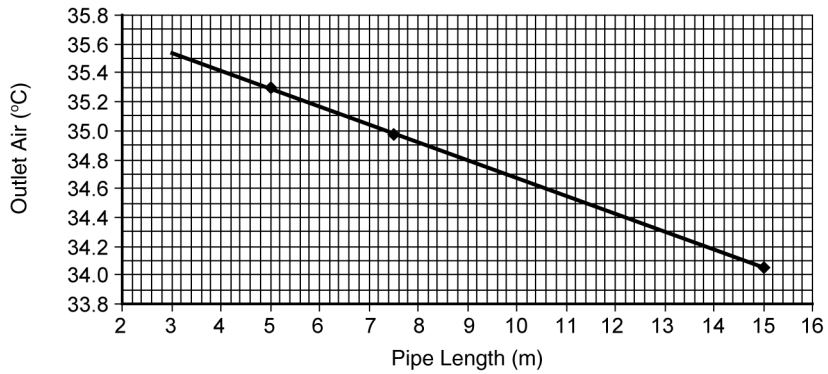

17.2. Airflow data

HE9LKE	Cooling	IVDS AF	Power Level dB	dB (A)	Heating	IVDS AF	Power level dB	dB (A)
SHi	1170	11.40			1230	12.50		
Hi	1090	10.50	55.00	39.00	1230	12.50	58.00	42.00
Me	880	8.00			990	9.30		
Lo	660	5.40	42.00	26.00	750	6.40	43.00	27.00
Lo -	560	4.20	39.00	23.00	650	5.30	40.00	24.00

HE12LKE	Cooling	IVDS AF	Power Level dB	dB (A)	Heating	IVDS AF	Power level dB	dB (A)
SHi	1210	11.90			1310	13.50		
Hi	1110	11.30	58.00	42.00	1310	13.50	60.00	44.00
Me	920	8.50			1090	10.50		
Lo	740	6.30	45.00	29.00	870	7.90	49.00	33.00
Lo -	640	5.10	42.00	26.00	770	6.70	46.00	30.00

17.3. Sensible Capacity Chart

• CS-HE9LKE CU-HE9LKE

230V Indoor wet bulb temp.	Outdoor Temp. (°C)											
	30			35			40			46		
	TC	SHC	IP	TC	SHC	IP	TC	SHC	IP	TC	SHC	IP
17.0°C	2.48	1.88	0.44	2.32	1.80	0.47	2.16	1.73	0.51	1.96	1.65	0.55
19.0°C				2.50		0.48						
19.5°C	2.72	1.97	0.45	2.55	1.89	0.48	2.37	1.82	0.52	2.15	1.73	0.56
22.0°C	2.97	2.04	0.46	2.77	1.96	0.49	2.58	1.89	0.52	2.35	1.81	0.57

• CS-HE12LKE CU-HE12LKE

230V Indoor wet bulb temp.	Outdoor Temp. (°C)											
	30			35			40			46		
	TC	SHC	IP	TC	SHC	IP	TC	SHC	IP	TC	SHC	IP
17.0°C	3.47	2.63	0.81	3.24	2.52	0.87	3.02	2.43	0.93	2.74	2.30	1.00
19.0°C				3.50		0.88						
19.5°C	3.81	2.76	0.82	3.56	2.65	0.88	3.31	2.55	0.95	3.01	2.43	1.02
22.0°C	4.15	2.86	0.84	3.88	2.75	0.90	3.61	2.65	0.96	3.28	2.53	1.04

TC - Total Cooling Capacity (kW)
 SHC - Sensible Heat Capacity (kW)
 IP - Input Power (kW)

Indoor 27°C/19°C
 Outdoor 35°C/24°C

18 Exploded View and Replacement Parts List

18.1. Indoor Unit

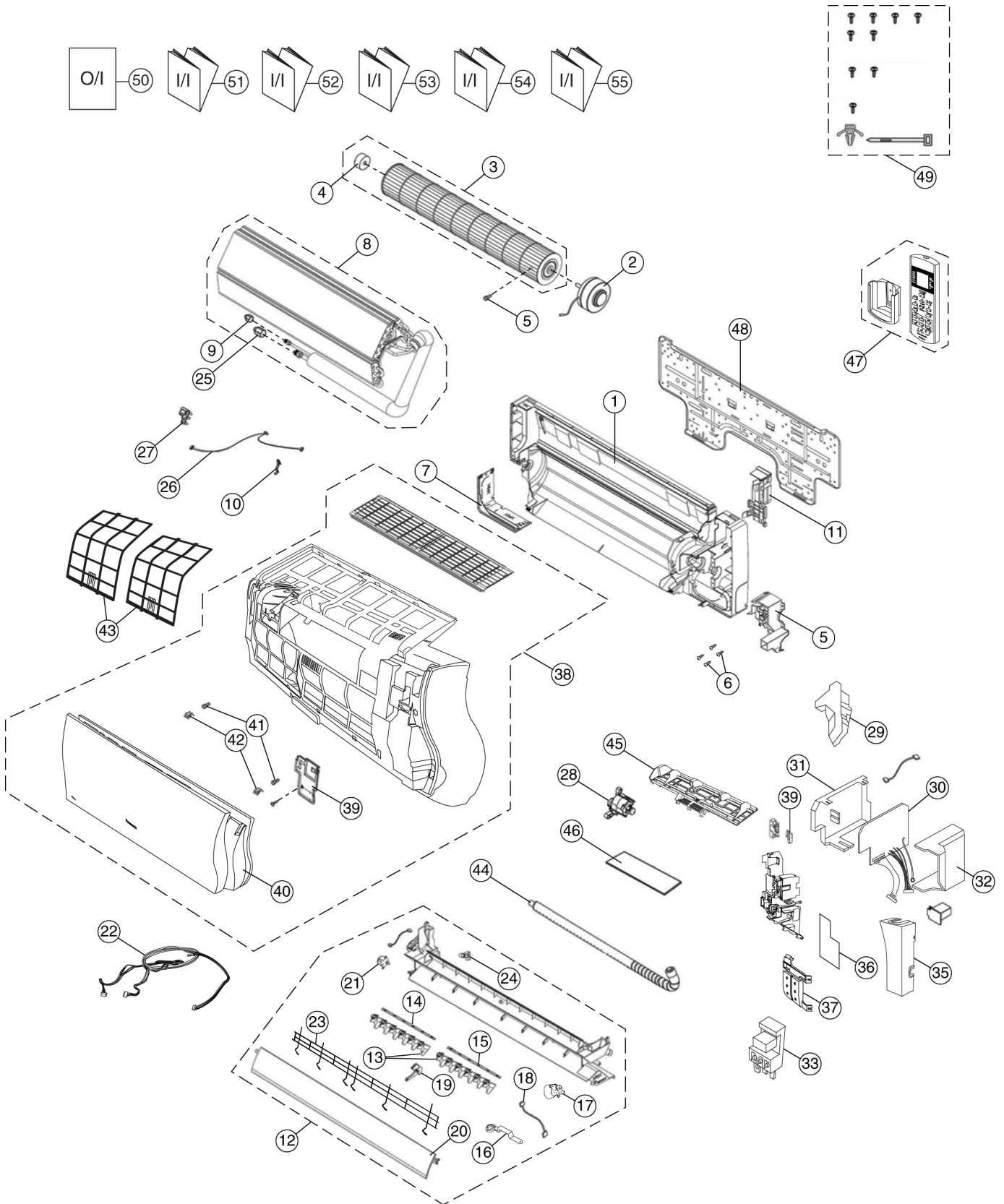

Note
 The above exploded view is for the purpose of parts disassembly and replacement.
 The non-numbered parts are not kept as standard service parts.

REF. NO.	DESCRIPTION & NAME	QTY.	CS-HE9LKE	CS-HE12LKE	REMARKS
1	CHASSY COMPLETE	1	CWD50C1551	←	
2	FAN MOTOR,DC 30W 3PH	1	CWA981194CB	←	O
3	CROSS-FLOW FAN CO.	1	CWH02C1090	←	
4	BEARING ASSY	1	CWH64K007	←	O
5	HOLDER-FAN MOTOR	1	CWD911313	←	
6	SCREW-HOLDER FAN MOTOR	4	XTT4+12CFJ	←	
7	L SHAPED PLATE-FOR CHASSY	1	CWD601065B	←	
8	EVAPORATOR CO.	1	CWB30C2285	←	
9	FLARE NUT(1/4)	1	CWT25086	←	
10	HOLDER SENSOR	1	CWH321085	←	
11	BACK COVER CHASSIS	1	CWD911316B	←	
12	DISCHARGE GRILLE COMPLETE	1	CWE20C2739	←	
13	VERTICAL VANE	16	CWE241239	←	
14	CONNECTING BAR	1	CWE261056A	←	
15	CONNECTING BAR	1	CWE261057A	←	
16	GEAR COMPLETE(VERTICAL VANE)	1	CWH68C1017	←	
17	AS MOTOR,DC SINGLE 12V 300 OHM	1	CWA981107J	←	O
18	LEAD WIRE FOR AIR SWING MOTOR	1	CWA67C4688	←	
19	FULCRUM	1	CWH621031A	←	
20	HORIZONTAL VANE COMPLETE	1	CWE24C1212	←	
21	A.S.MOTOR,DC SINGLE 12V250 OHM	1	CWA981105J	←	O
22	LEADWIRE (A.S MOTOR AND GEAR)	1	CWA67C5748	←	
23	WIRE NET	1	CWD041083	←	
24	CAP-DRAIN TRAY	1	CWH521091	←	
25	FLARE NUT (3/8)(1/2)	1	CWT251031	←	
26	SENSOR COMPLETE	1	CWA50C2467	←	O
27	HOLDER SENSOR	1	CWH32137	←	
28	GEAR-COMPLETE(INTAKE GRILLE)	1	CWH68C1021	←	
29	PIPE COVER	1	CWD911317	←	
30	ELECTRONIC CONTROLLER-MAIN	1	CWA73C4769	←	O
31	CONTROL BOARD COVER (L)	1	CWH131163	←	
32	CONTROL BOARD COVER (R)	1	CWH13K1010	←	
33	TERMINAL BOARD CO	1	CWA28C2433	←	O
35	CONTROL BOARD COVER(F)	1	CWH131165	←	
36	ELECTRONIC CON(RCVR-INDICATOR)	1	CWA745633	←	O
37	INDICATOR HOLDER	1	CWD932309	←	
38	FRONT GRILLE COMPLETE	1	CWE11C4288	←	O
39	GRILLE DOOR	1	CWE14C1069	←	
40	INTAKE GRILLE COMPLETE	1	CWE22C1397	←	
41	SCREW-FRONT GRILLE	3	XTT4+16CFJ	←	
42	CAP-FRONT GRILLE	2	CWH521088	←	
43	AIR FILTER	2	CWD001163	←	O
44	FLEXIBLE PIPE	1	CWH851110	←	
45	FRAME FOR AIR FILTER	1	CWD661108	←	
46	SUPER ALLERU BUSTER FILTER	1	CWD00C1263	←	O
47	REMOTE CONTROL COMPLETE	1	CWA75C3636	←	O
48	INSTALLATION HOLDER	1	CWH36C1019	←	
49	BAG COMPLETE - INSTALLATION SCREW	1	CWH82C1496	←	
50	OPERATING INSTRUCTION	1	CWF567549	←	
51	INSTALLATION INSTRUCTION	1	CWF614492	←	
52	INSTALLATION INSTRUCTION	1	CWF614493	←	
53	INSTALLATION INSTRUCTION	1	CWF614494	←	
54	INSTALLATION INSTRUCTION	1	CWF614495	←	
55	INSTALLATION INSTRUCTION	1	CWF614496	←	

(NOTE)

- All parts are supplied from PHAAM, Malaysia (Vendor Code: 00029488).

18.2. Outdoor Unit

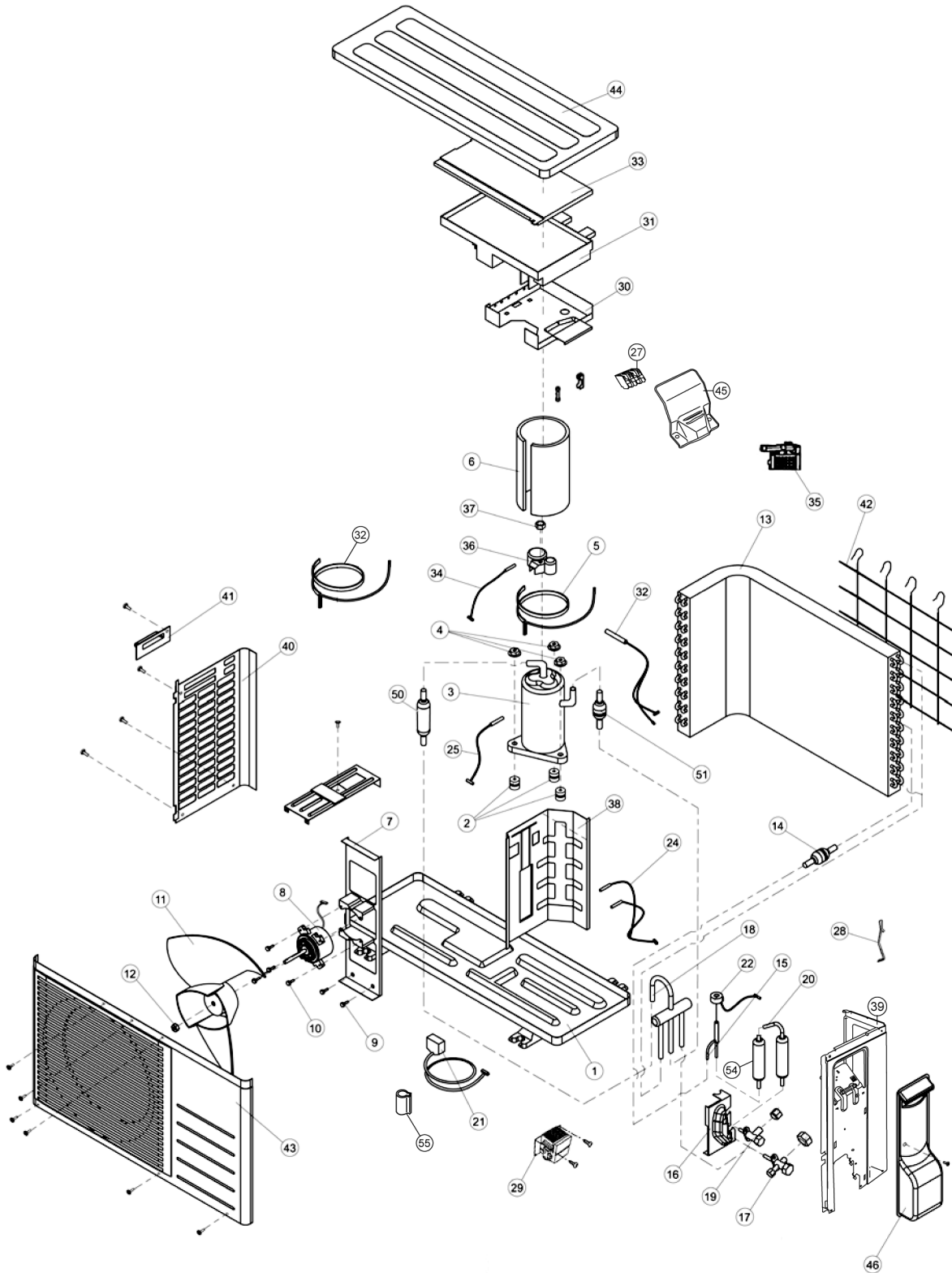

Note

The above exploded view is for the purpose of parts disassembly and replacement.
The non-numbered parts are not kept as standard service parts.

REF. NO.	DESCRIPTION & NAME	QTY.	CU-HE9LKE	CU-HE12LKE	REMARKS
1	CHASSY ASS'Y	1	CWD50K2202	←	
2	ANTI-VIBRATION BUSHING	3	CWH50077	←	
3	COMPRESSOR	1	5CS110XBD04	←	O
4	NUT-COMPRESSOR MOUNT	3	CWH56000J	←	
5	CRANKCASE HEATER	1	CWA341050	←	
6	SOUND PROOF MATERIAL	1	CWG302464	←	
7	BRACKET FAN MOTOR	1	CWD541089	←	
8	FAN MOTOR,DC 40W 3PH	1	ARW44X8P40AC	←	O
9	SCREW - FAN MOTOR BRACKET	2	CWH551217	←	
10	SCREW-FAN MOTOR MOUNT	4	CWH55252J	←	
11	PROPELLER FAN ASSY	1	CWH03K1014	←	
12	NUT-PROPELLER FAN	1	CWH56053J	←	
13	CONDENSER COMPLETE	1	CWB32C2875	←	
14	STRAINER	1	CWB111004	←	
15	EXPANSION VALVE	1	CWB051016J	←	
16	HOLDER-COUPLING	1	CWH351025	←	
17	3-WAYS VALVE	1	CWB011434	←	O
18	4-WAYS VALVE	1	CWB001037J	←	O
19	2-WAYS VALVE	1	CWB021400	←	O
20	ACCUMULATOR	1	CWB131044	←	
21	V-COIL CO.FOR 4-WAY VALVE	1	CWA43C2144J	←	O
22	V-COIL COMPLETE FOR EXP.VALVE	1	CWA43C2058J	←	O
24	SENSOR-COMPLETE	1	CWA50C2402	←	O
25	SENSOR-COMPLETE	1	CWA50C2512	←	O
27	TERMINAL BOARD ASS'Y	1	CWA28K1110J	←	O
28	HOLDER-SENSOR	2	CWH32143	←	
29	REACTOR	1	G0C193J00004	←	O
30	CONTROL BOARD CASING	1	CWH102371	←	
31	ELECTRONIC CONTROLLER-MAIN	1	CWA73C4798R	CWA73C4799R	O
32	CRANKCASE HEATER	1	CWA341060	←	
33	CONTROL BOARD COVER	1	CWH131264	←	
34	SENSOR-COMPLETE	1	CWA50C2205	←	O
35	HOLDER-SENSOR	1	CWH321023	←	
36	TERMINAL COVER	1	CWH171039A	←	
37	NUT-TERMINAL COVER	1	CWH7080300J	←	
38	SOUND-PROOF BOARD	1	CWH151176	←	
39	CABINET SIDE PLATE(R)	1	CWE04C1213	←	
40	CABINET SIDE PLATE(L)	1	CWE041278A	←	
41	HANDLE	1	CWE161010	←	
42	WIRE NET	1	CWD041111A	←	
43	CABINET FRONT PLATE-COMPLETE	1	CWE06C1136	←	
44	CABINET TOP PLATE	1	CWE031014A	←	
45	CONTROL BOARD COVER	1	CWH131301	←	
46	CONTROL BOARD COVER-COMPLETE	1	CWH13C1064	←	
50	RECEIVER	1	CWB14011	←	
51	STRAINER	1	CWB11094	←	
54	DRYER	1	CWB101016J	←	
55	HOLDER-SENSOR	1	CWH32075	←	

(NOTE)

- All parts are supplied from PHAAM, Malaysia (Vendor Code: 00029488).
- "O" marked parts are recommended to be kept in stock.