

Service Manual

Air Conditioner

CS-XE9DKE CU-XE9DKE
CS-XE12DKE CU-XE12DKE



⚠ WARNING

This service information is designed for experienced repair technicians only and is not designed for use by the general public. It does not contain warnings or cautions to advise non-technical individuals of potential dangers in attempting to service a product. Products powered by electricity should be serviced or repaired only by experienced professional technicians. Any attempt to service or repair the product or products dealt with in this service information by anyone else could result in serious injury or death.

⚠ PRECAUTION OF LOW TEMPERATURE

In order to avoid frostbite, be assured of no refrigerant leakage during the installation or repairing of refrigeration circuit.

CONTENTS

	Page		Page
1 Features	2	8.1. Basic Function	15
2 Functions	3	8.2. Protection Control Features	30
2.1. REMOTE CONTROL	3	8.3. Oxygen Enrich Operation	40
2.2. INDOOR UNIT	4	9 Operating Instructions	52
2.3. OUTDOOR UNIT	5	10 Installation Instructions	58
3 Product Specifications	6	10.1. Safety Precautions	58
3.1. CS-XE9DKE CU-XE9DKE	6	10.2. Indoor Unit	61
3.2. CS-XE12DKE CU-XE12DKE	8	10.3. Outdoor Unit	65
4 Dimensions	10	11 Installation and Servicing Air Conditioner Using R410A	69
5 Refrigeration Cycle Diagram	12	11.1. Outline	69
6 Block Diagram	13	11.2. Tools For Installing/Servicing Refrigerant Piping	70
7 Wiring Diagram	14	11.3. Refrigerant Piping Work	74
8 Operation Details	15	11.4. Installation, Transferring, Servicing	76

Panasonic®

© 2005 Panasonic HA Air-Conditioning (M) Sdn Bhd (11969-T). All rights reserved. Unauthorized copying and distribution is a violation of law.

12 Servicing Information	80	17.1. CU-XE9DKE CU-XE12DKE	95
12.1. Troubleshooting	80	18 Electronic Circuit Diagram	96
12.2. Breakdown Self Diagnosis Function	82	18.1. Remote Control	104
12.3. Remote Control	84	18.2. Print Pattern Indoor Unit Printed Circuit Board (Main) --	105
12.4. Disassembly Of Parts	85	18.3. Print Pattern Indoor Unit Printed Circuit Board (Power)-	106
13 Technical Data	89	18.4. Print Pattern Indicator Display	106
14 Exploded View (Indoor Unit)	92	18.5. Print Pattern Outdoor Unit Printed Circuit Board (Main)	107
14.1. CS-XE9DKE CS-XE12DKE	92	18.6. Print Pattern Outdoor Unit Printed Circuit Board (Oxygen)	108
15 Replacement Parts List (Indoor Unit)	93		
15.1. CS-XE9DKE CS-XE12DKE	93		
16 Exploded View (Outdoor Unit)	94		
16.1. CU-XE9DKE CU-XE12DKE	94		
17 Replacement Parts List (Outdoor Unit)	95		

1 Features

• Product

- Microcomputer-controlled compressor operating frequency.
- Vertical and horizontal airflow directions.
- Five modes of operation selection.
- Air filter with function to reduce dust and smoke.
- Ionizer control for generate negative ion in discharge air.
- Quiet mode to provide quiet operation.
- Oxygen mode to supply oxygen enrich air to indoor room.
- 24-hour timer setting.
- Long installation piping up to 15 meter.
- Super Alleru-Buster Filter prevent the growth of bacteria, viruses trapped, trap dust, tobacco smoke and tiny particles.

• Quality Improvement

- Random auto restart after power failure for safety restart operation.
- Gas leakage detection.

• Serviceability

- Removeable and washable front panel.
- Breakdown self diagnosis function.

• Environmental Protection

- Non-ozone depletion substances refrigerant (R410A).

2 Functions

2.1. REMOTE CONTROL

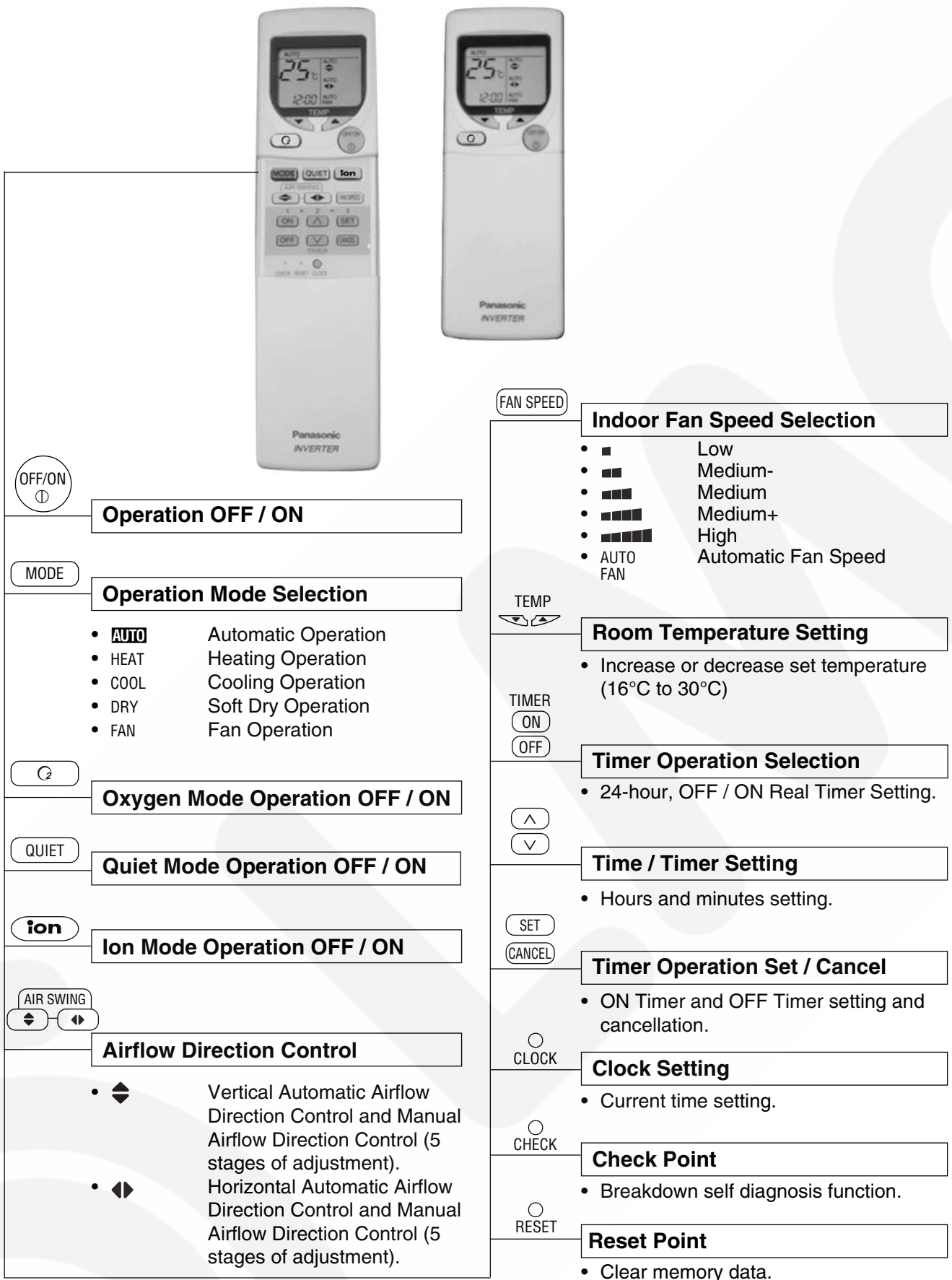

2.2. INDOOR UNIT



AUTO
OFF / ON

Automatic Operation Switch

- Press for < 5s to operate Automatic operation mode.
(Used when the remote control cannot be used.)
- Press continuously for 5s or < 8s to operate Test Run/Pump down. “Beep” sound will be heard.
(Used when test running or servicing.)
- Press continuously for 8s or < 11s to operate Forced Heating Operation. “Beep, beep” sound will be heard.
- Press continuously for 11s or < 16s to change different remote control setting (A↔B Mode), or testify oxygen operation “Beep, beep, beep” sound will be heard.
- Press continuously for 16s or < 21s to omit or resume the remote control signal receiving sound or H14 Abnormality Detection Mode.

Operation Indication Lamps (LED)

- POWER (Green) Lights up in operation, blinks in Automatic Operation Mode judging deice, ON Timer sampling and Hot Start operation.
- **Qair** (Green) Lights up in Oxygen Mode Operation.
- ION (Green) Lights up in Ionizer Mode Operation. Blinks in Ionizer error.
- QUIET (Orange) Lights up in Quiet Mode Operation.
- TIMER (Orange) Lights up in Timer Setting. Blinks in Self Diagnosis Control.

Five Operation Modes

- Heating, Cooling, Soft Dry, Fan and Automatic Mode.

Oxygen Operation

- To supply oxygen enrich air.

Quiet Operation

- To provide quiet operation.

Ionizer Control

- Ionizer control for generate negative ion in discharge air.

Automatic and 5 Manual Indoor Fan Speeds

Automatic and 5 Manual Vertical Airflow Directions

Automatic and 5 Manual Horizontal Airflow Directions

Random Auto Restart Control

- Operation is restarted randomly after power failure at previous setting mode.

Delay ON Timer and OFF Timer

Microcomputer-controlled Room Temperature Control

Breakdown Self Diagnosis Function

Low Pressure Control (Gas Leakage Detection)

Indoor Power Relay Control

Deodorizing Control

Anti-Dew Formation Control

Anti Freezing Control

Anti-Cold Draft Control

Hot Start

Intake Air Temperature Control

High Pressure Control

Deice Operation

2.3. OUTDOOR UNIT



Time Delay Safety Control

30 seconds Forced Operation

Overload Protection

Total Running Current Control

**Compressor Overheating
Prevention Control**

**IPM (Power Transistor)
Overheating Protection Control**



**Low Operation Frequency
Protection Control**

**Outdoor Air Temperature
Control**

Deice Operation

3 Product Specifications

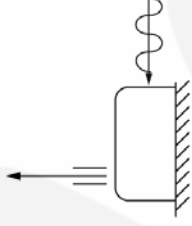
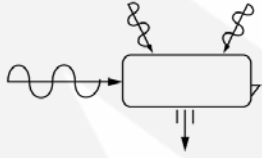

3.1. CS-XE9DKE CU-XE9DKE

		Unit	CS-XE9DKE	CU-XE9DKE
Cooling Capacity		kW kcal/h BTU/h	2.6 (0.60 - 3.00) 2,240 (520 - 2,580) 8,870 (2,050 - 10,200)	
Heating Capacity		kW kcal/h BTU/h	3.6 (0.60 - 5.00) 3,100 (520 - 4,300) 12,300 (2,050 - 17,100)	
Moisture Removal		l/h Pint/h	1.6 (3.4)	
Power Source (Phase, Voltage, Cycle)		ø V Hz	Single 230 50	
Airflow Method		<p>OUTLET</p>  <p>INTAKE</p> 	<p>SIDE VIEW</p> 	<p>TOP VIEW</p> 
Air Volume	Lo	m ³ /min (cfm)	Cooling; 6.5 (231) Heating; 7.1 (249)	—
	Me	m ³ /min (cfm)	Cooling; 8.1 (286) Heating; 8.8 (312)	—
	Hi	m ³ /min (cfm)	Cooling; 9.9 (350) Heating; 10.6 (370)	Cooling; 30.0 (1,060)
Noise Level		dB (A)	Cooling; High 39, Low 26 Heating; High 40, Low 27	Cooling; 46 Heating; 47
		Power level dB	Cooling; High 50 Heating; High 51	Cooling; High 59 Heating; High 60
Electrical Data	Input	W	Cooling; 700 (115 - 880) Heating; 900 (110 - 1,400)	
	Running Current	A	Cooling; 3.3 Heating; 4.0	
	EER	W/W (kcal/hw), BTU/hw	Cooling; 3.71(3.20), 12.7	
	COP	W/W (kcal/hw), BTU/hw	Heating; 4.00 (3.44), 13.7	
	Starting Current	A	4.00	
Piping Connection Port (Flare piping)		inch inch	G ; Half Union 3/8" L ; Half Union 1/4"	G ; 3-way valve 3/8" L ; 2-way valve 1/4"

		Unit	CS-XE9DKE	CU-XE9DKE	
Pipe Size (Flare piping)		inch inch	G (gas side) ; 3/8" L (liquid side) ; 1/4"	G (gas side) ; 3/8" L (liquid side) ; 1/4"	
Drain Hose	Inner diameter	mm	16	—	
	Length	m	0.65	—	
Power Cord Length			2.1 m	—	
Number of core-wire			3 core wires × 1.0 mm ²	—	
Dimensions	Height	inch (mm)	10 - 26/32 (275)	21 - 9/32 (540)	
	Width	inch (mm)	31 - 15/32 (799)	30 - 23/32 (780)	
	Depth	inch (mm)	9 - 9/32 (236)	11 - 3/8 (289)	
Net Weight		lb (kg)	22 (10.0)	84 (38)	
Compressor	Type		—	Involute scroll	
	Motor Type		—	Brushless (4-pole)	
	Rated Output	W	—	700	
Air Circulation	Type		Cross-flow Fan	Propeller Fan	
	Material		AS + Glass Fiber 20%	P.P	
	Motor Type		Transistor (8-poles)	Induction (6-poles)	
	Input	W	—	61.3	
	Rate Output	W	30	25	
	Fan Speed	Lo (Cool/Heat)	rpm	800 / 840	—
		Me (Cool/Heat)	rpm	1,000 / 1,040	—
Hi (Cool/Heat)		rpm	1,240 / 1,270	770	
Heat Exchanger	Description		Evaporator	Condenser	
	Tube material		Copper	Copper	
	Fin material		Aluminium (Pre Coat)	Aluminium	
	Fin Type		Slit Fin	Corrugated Fin	
	Row / Stage		(Plate fin configuration, forced draft) 2 / 15	1 / 20	
	FPI		21	19	
	Size (W × H × L)	mm	610 × 315 × 25.4	732.1 × 508 × 22	
Refrigerant Control Device			—	Capillary Tube	
Refrigeration Oil		(c.c)	—	RB68A (360)	
Refrigerant (R410A)		g (oz)	—	840 (29.7)	
Thermostat			Electronic Control	—	
Protection Device			Electronic Control	Electronic Control	
Capillary Tube	Length	mm	—	C1, C2 ; 1,100, C3 ; 440	
	Flow Rate	l/min	—	C1, C2 ; 5.0, C3 ; 18.6	
	Inner Diameter	mm	—	C1, C2 ; 1.2, C3 ; 1.7	
Air Filter	Material		P.P.	—	
	Style		Honeycomb	—	
Fan Motor Capacitor		μF, VAC	—	1.8 μF, 400 VAC	

- Specifications are subject to change without notice for further improvement.

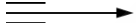
3.2. CS-XE12DKE CU-XE12DKE

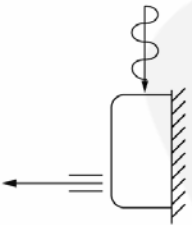
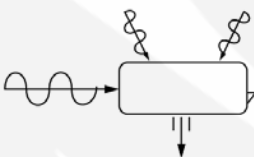
		Unit	CS-XE12DKE	CU-XE12DKE
Cooling Capacity		kW kcal/h BTU/h	3.45 (0.60 - 4.00) 2,970 (520 - 3,440) 11,800 (2,050 - 13,600)	
Heating Capacity		kW kcal/h BTU/h	4.80 (0.60 - 6.50) 4,130 (520 - 5,590) 16,400 (2,050 - 22,200)	
Moisture Removal		l/h Pint/h	2.0 (4.2)	
Power Source (Phase, Voltage, Cycle)		ø V Hz	Single 230 50	
Airflow Method		OUTLET  INTAKE 	SIDE VIEW 	TOP VIEW 
Air Volume	Lo	m ³ /min (cfm)	Cooling; 7.3 (258) Heating; 9.2 (325)	—
	Me	m ³ /min (cfm)	Cooling; 9.2 (323) Heating; 10.3 (360)	—
	Hi	m ³ /min (cfm)	Cooling; 10.9 (380) Heating; 11.8 (420)	Cooling; 31.0 (1,090)
Noise Level		dB (A)	Cooling; High 42, Low 29 Heating; High 42, Low 33	Cooling; 48 Heating; 50
		Power level dB	Cooling; High 53 Heating; High 53	Cooling; High 61 Heating; High 63
Electrical Data	Input	W	Cooling; 950 (120 - 1,280) Heating; 1,260 (115 - 1,890)	
	Running Current	A	Cooling; 4.4 Heating; 5.6	
	EER	W/W (kcal/hw), BTU/hw	Cooling; 3.63 (3.13), 12.4	
	COP	W/W (kcal/hw), BTU/hw	Heating; 3.81 (3.28), 13.0	
	Starting Current	A	5.60	
Piping Connection Port (Flare piping)		inch inch	G ; Half Union 1/2" L ; Half Union 1/4"	G ; 3-way valve 1/2" L ; 2-way valve 1/4"
Pipe Size (Flare piping)		inch inch	G (gas side) ; 1/2" L (liquid side) ; 1/4"	G (gas side) ; 1/2" L (liquid side) ; 1/4"

		Unit	CS-XE12DKE	CU-XE12DKE	
Drain Hose	Inner diameter	mm	16	—	
	Length	m	0.65	—	
Power Cord Length			2.1 m	—	
Number of core-wire			3 core wires × 1.0 mm ²	—	
Dimensions	Height	inch (mm)	10 - 26/32 (275)	21 - 9/32 (540)	
	Width	inch (mm)	31 - 15/32 (799)	30 - 23/32 (780)	
	Depth	inch (mm)	9 - 9/32 (236)	11 - 3/8 (289)	
Net Weight		lb (kg)	22 (10.0)	88 (40)	
Compressor	Type		—	Involute scroll	
	Motor Type		—	Brushless (4-pole)	
	Rated Output	W	—	700	
Air Circulation	Type		Cross-flow Fan	Propeller Fan	
	Material		AS + Glass Fiber 20%	P.P	
	Motor Type		Transistor (8-poles)	Induction (6-poles)	
	Input	W	—	65.9	
	Rate Output	W	30	29	
	Fan Speed	Lo (Cool/Heat)	rpm	880 / 1,100	—
		Me (Cool/Heat)	rpm	1,100 / 1,230	—
Hi (Cool/Heat)		rpm	1,310 / 1,410	830	
Heat Exchanger	Description		Evaporator	Condenser	
	Tube material		Copper	Copper	
	Fin material		Aluminium (Pre Coat)	Aluminium	
	Fin Type		Slit Fin	Corrugated Fin	
	Row / Stage		(Plate fin configuration, forced draft)		
			2 / 15	2 / 24	
	FPI		21	17	
Size (W × H × L)	mm	610 × 315 × 25.4	703.8 × 504 × 36.4 735.0		
Refrigerant Control Device			—	Capillary Tube	
Refrigeration Oil		(c.c)	—	RB68A (360)	
Refrigerant (R410A)		g (oz)	—	1,020 (36.0)	
Thermostat			Electronic Control	—	
Protection Device			Electronic Control	Electronic Control	
Capillary Tube	Length	mm	—	C1, C2 ; 1,100, C3 ; 750	
	Flow Rate	l/min	—	C1, C2 ; 5.0, C3 ; 15.4	
	Inner Diameter	mm	—	C1, C2 ; 1.2, C3 ; 1.7	
Air Filter	Material		P.P.	—	
	Style		Honeycomb	—	
Fan Motor Capacitor		μF, VAC	—	2.0 μF, 400 VAC	

- Specifications are subject to change without notice for further improvement.

4 Dimensions

CS-XE9DKE CS-XE12DKE (Indoor Unit)

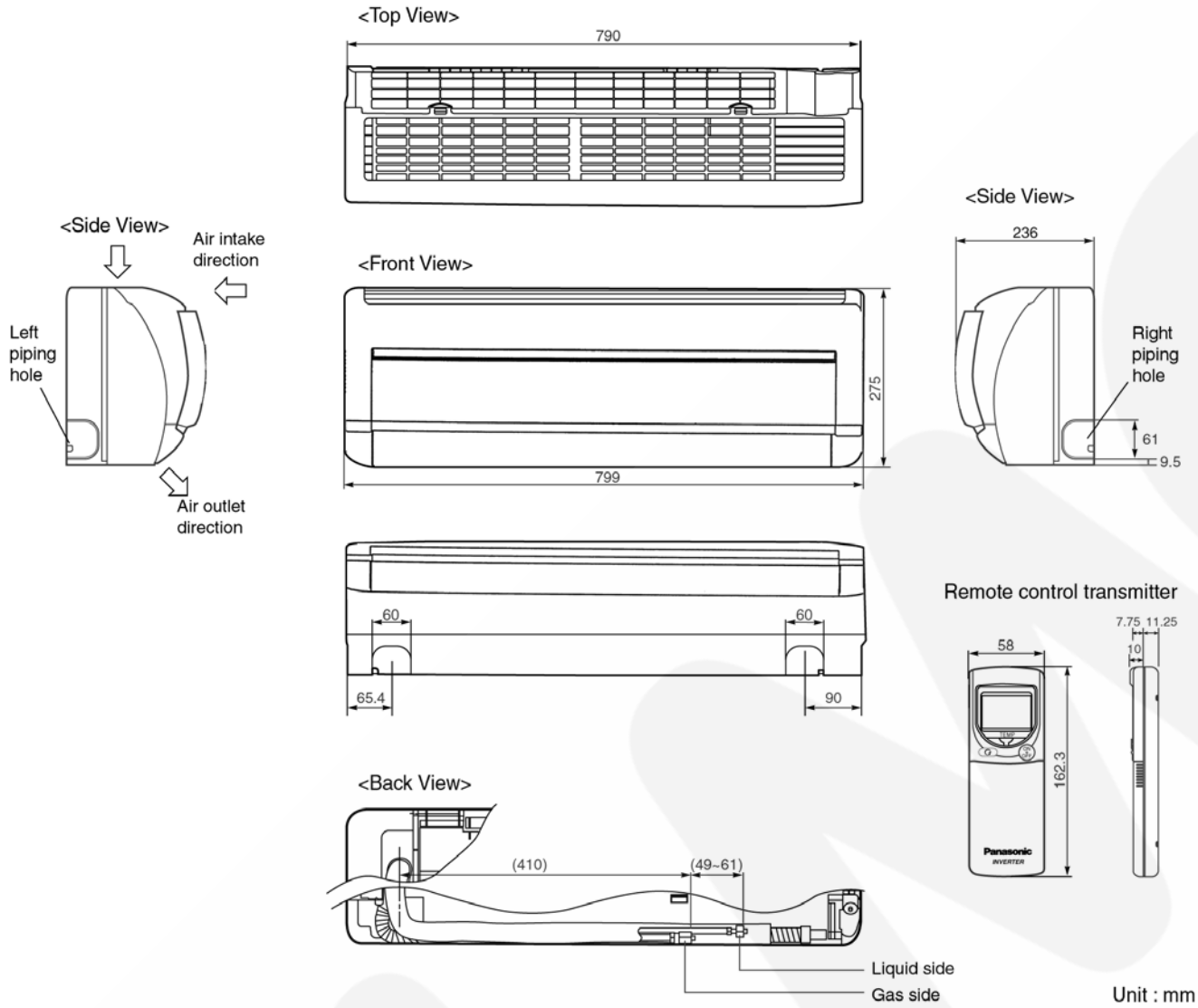

Relative position between the indoor unit and the installation plate <Front View>

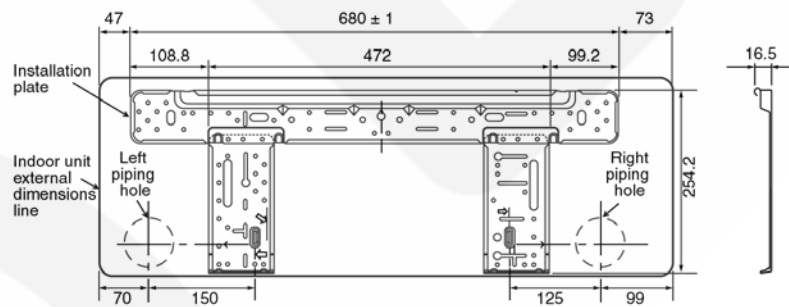

CU-XE9DKE CU-XE12DKE (Outdoor Unit)

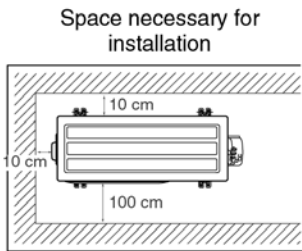

Anchor Bolt Pitch
320 x 570

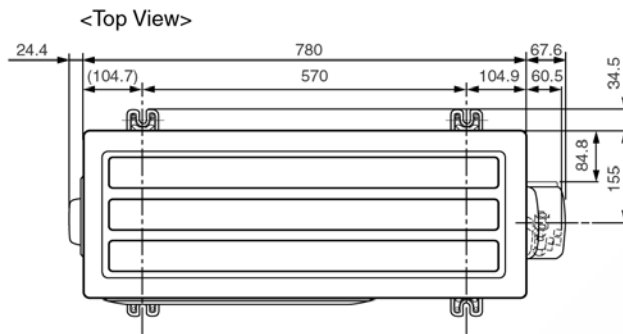

2-way valve at Liquid side
(High Pressure)

3-way valve at Gas side
(Low Pressure)

<Side View>

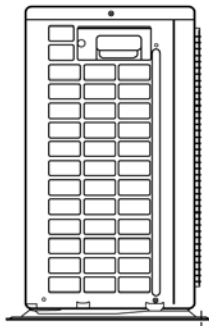

Unit: mm

<Front View>

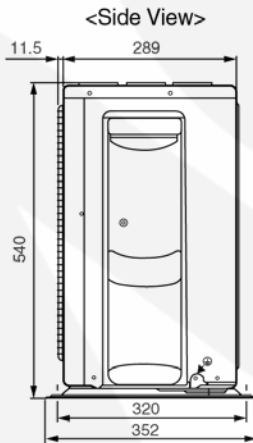
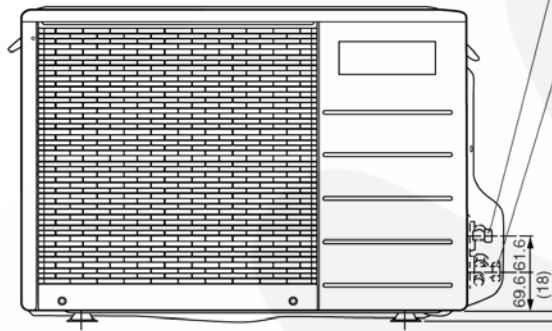

5 Refrigeration Cycle Diagram

CS-XE9DKE CU-XE9DKE
 CS-XE12DKE CU-XE12DKE

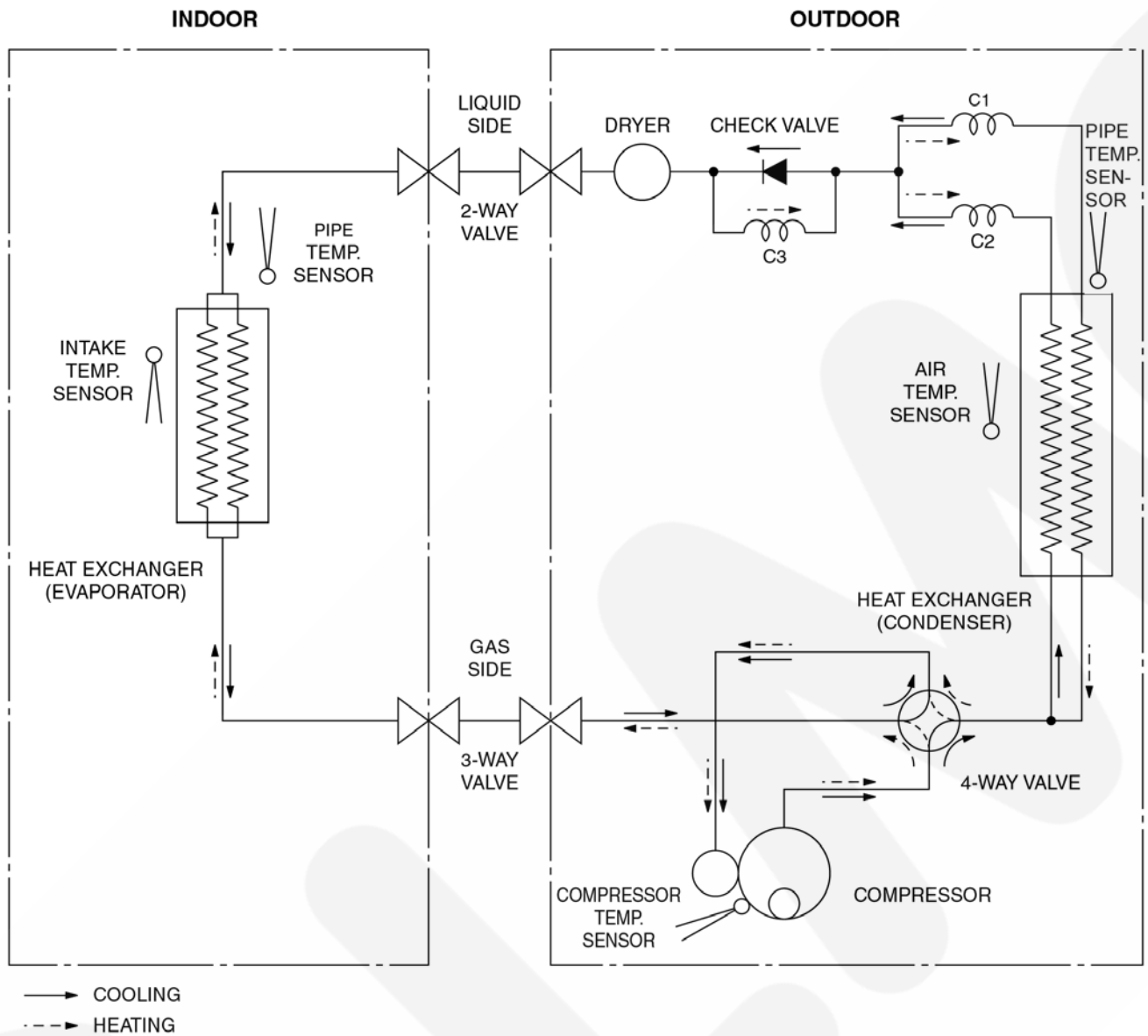

6 Block Diagram

CS-XE9DKE CU-XE9DKE
CS-XE12DKE CU-XE12DKE

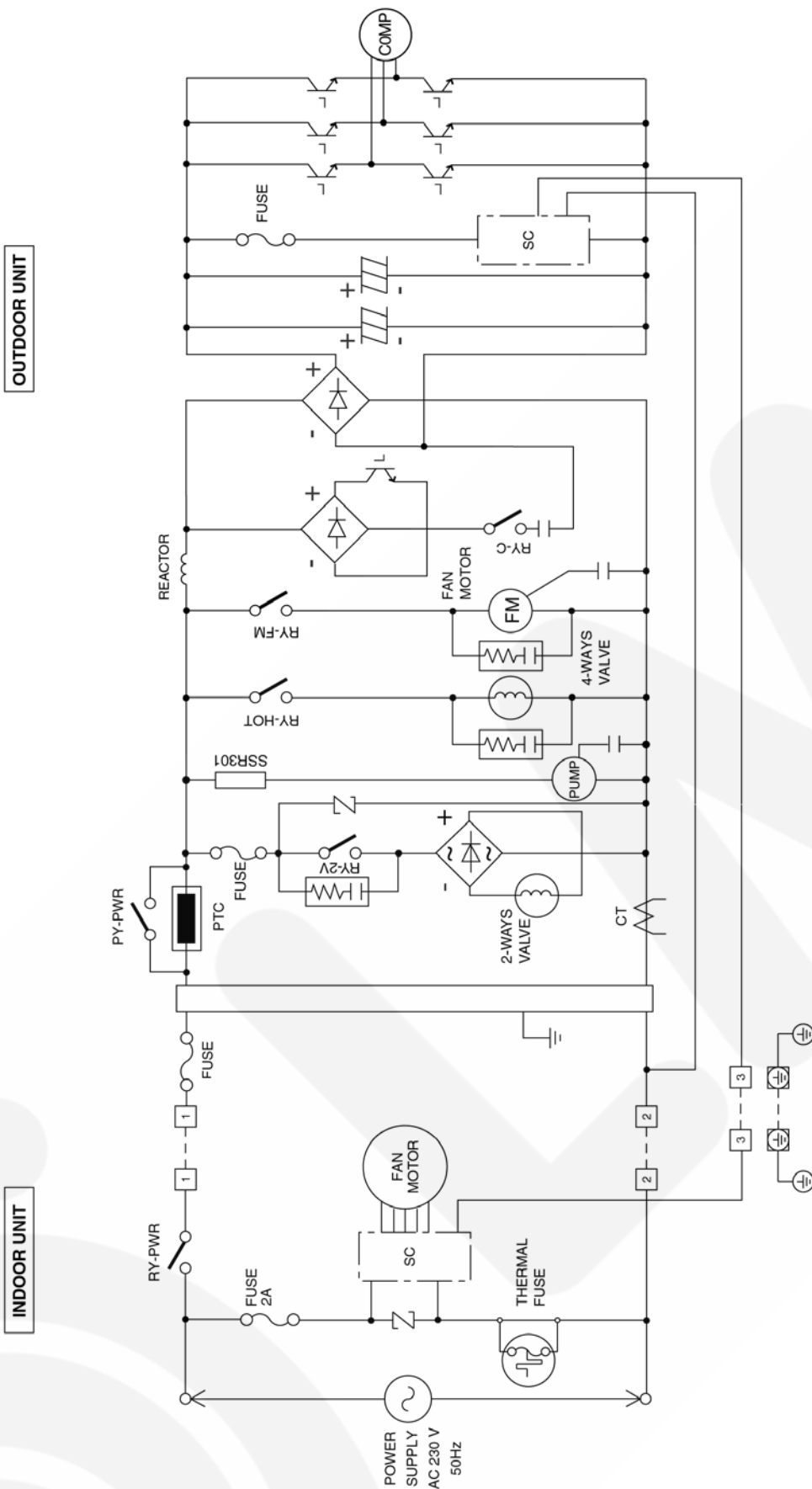

7 Wiring Diagram

CS-XE9DKE CU-XE9DKE CS-XE12DKE CU-XE12DKE

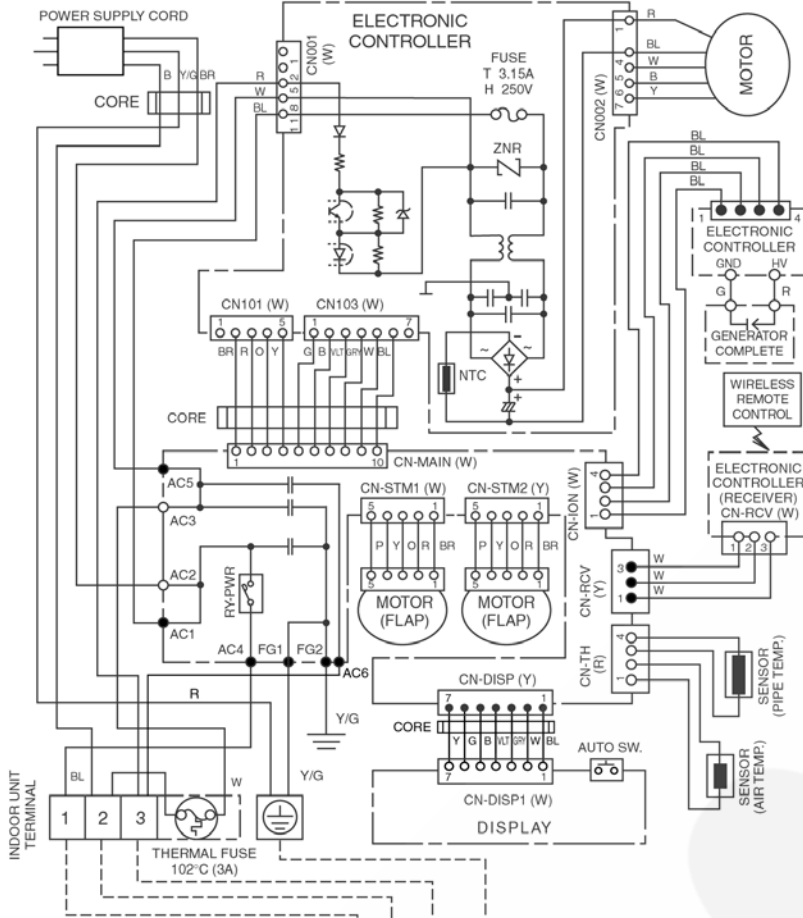

- Remarks:**
- B : BLUE
 - BR : BROWN
 - BL : BLACK
 - W : WHITE
 - GR : GREEN
 - R : RED
 - O : ORANGE
 - P : PINK
 - V : VIOLET
 - GRY : GRAY
 - Y/G : YELLOW / GREEN

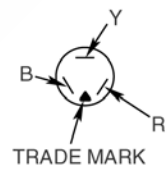
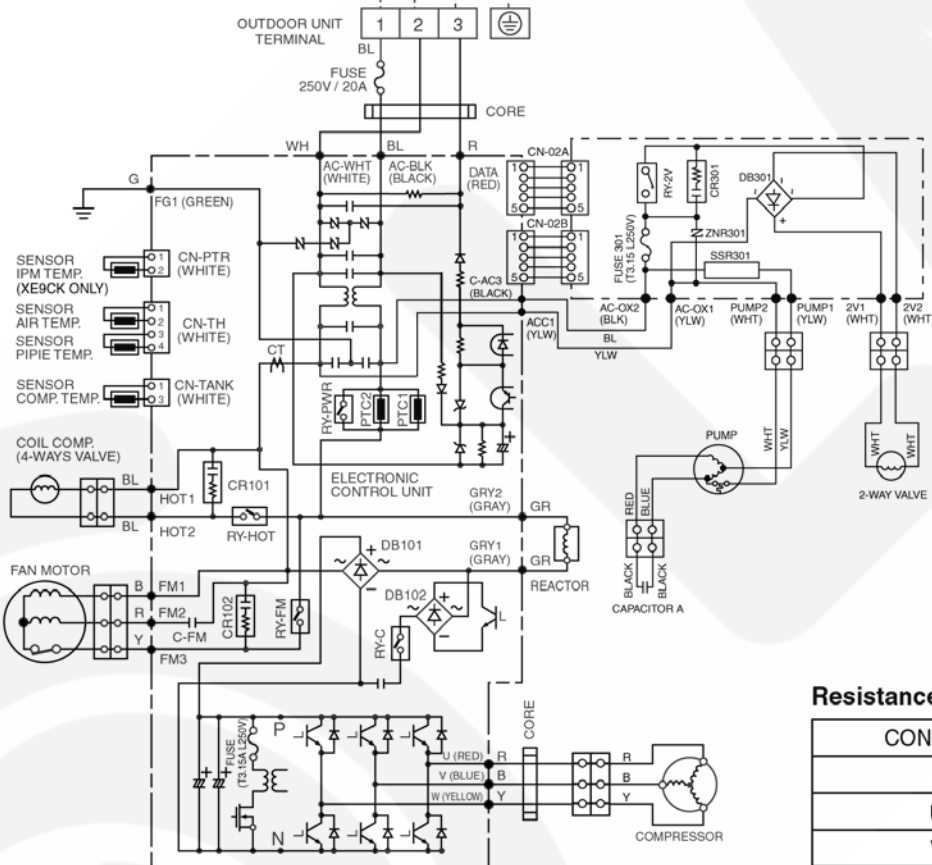

Resistance of Compressor Windings

CONNECTION	5CS102XEC (Ω)
U - V	1.082
U - W	1.066
V - W	1.100

8 Operation Details

8.1. Basic Function

Inverter control, which is equipped with a microcomputer to determine the most suitable operating mode as time passes, automatically adjusts output power for maximum comfort. In order to achieve the suitable operating mode, the microcomputer maintains the set temperature by measuring the temperature of the environment and performing temperature shifting. The compressor at the outdoor unit is operating following the frequency instructed by the microcomputer at the indoor unit, which judges the condition according to the internal setting temperature and intake air temperature.

8.1.1. Internal Setting Temperature

Once the operation starts, the remote control setting temperature will be taken as the base value for temperature shifting processes. These shifting processes depend on the air conditioner settings and the operation environment. The final shifted value will be used as the internal setting temperature and is updated continuously whenever the electrical power is supplied to the unit.

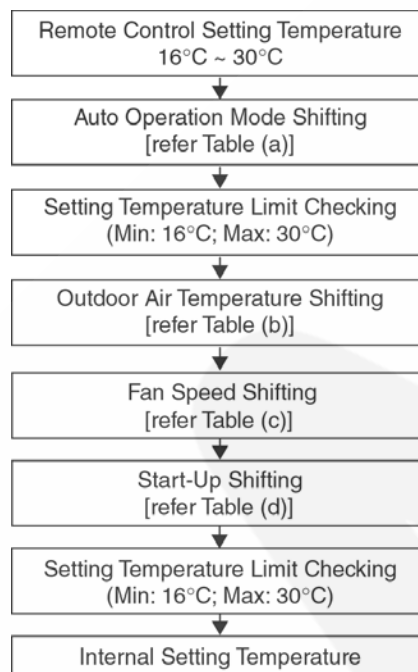

Table (a): Auto Operation Mode Setting

Mode Shift:	Temperature Shift (°C)
Cooling/Soft Dry → Heating	-2.0
Heating → Cooling/Soft Dry	+2.0

Table (b): Outdoor Air Temperature Shifting

Mode:	Outdoor Temperature, X (°C):	Temperature Shift (°C)	
		XE9DK	XE12DK
Cooling/Soft Dry	$38 \leq X$	0.00	0.00
	$30 \leq X < 38$	0.00	0.00
	$23 \leq X < 30$	0.00	0.00
	$X < 23$	0.00	0.00
Heating	$21 \leq X$	0.00	0.00
	$17 \leq X < 21$	0.00	0.00
	$9 \leq X < 17$	0.00	0.00
	$5 \leq X < 9$	+0.50	+1.00
	$1 \leq X < 5$	+1.00	+1.25
	$X < 1$	+1.50	+2.00

Table (c): Fan Speed Shifting

Mode:	Fan Speed:	Temperature Shift (°C)
Cooling	All	+1.25
Soft Dry	All	+1.0
Heating	Lo	+1.0
	Hi, Me-, Me, Me+, Auto	+0.25 (XE9DK), +0.50 (XE12DK)

Table (d): Start-Up Shifting

Mode within 60 Minutes from Start-up:	Temperature Shift (°C)
Cooling/Soft Dry	-1.0
Heating	+2.0

8.1.2. Compressor Operation Frequency

Zone	Intake Air Temperature - Internal Setting Temperature (°C)			Freq. H						Remark
	Cooling	Soft Dry	Heating	Cooling		Soft Dry		Heating		
				XE9DK	XE12DK	XE9DK	XE12DK	XE9DK	XE12DK	
1	-2.0	-3.0	1.0	2	1	5	5	1	1	
2	-1.5	-2.5	0.5	2	5	10	10	3	8	
3	-1.0	-2.0	0.0	4	8	10	10	6	13	
4	-0.5	-1.5	-0.5	9	12	10	12	11	18	
5	0.0	-1.0	-1.0	11	14	12	14	15	23	
6	0.5	-0.5	-1.5	14	18	12	17	18	27	
7	1.0	0.0	-2.0	17	22	14	17	21	30	
8	1.5	0.5	-2.5	20	27	14	20	25	32	Fc, Fh
9	2.0	1.0	-3.0	20	27	16	24	25	32	Fc, Fh
10	2.5	1.5	-3.5	20	27	20	27	25	32	Fc, Fh
11	Nil	Nil	-4.0	Nil	Nil	Nil	Nil	25	32	Fh
12	Nil	Nil	-4.5	Nil	Nil	Nil	Nil	25	32	Fh

Operating Frequency Calculation Formula:

$$\text{CompHz} = \text{Freq. A} \times \text{Freq. H} + \text{Freq. C}$$

Example Calculation:

Model No.: XE9DK

Operation Mode: Cooling

When Intake Air Temperature - Internal setting Temperature:
1.5°C

$$\begin{aligned} \text{CompHz} &= \text{Freq. A} \times \text{Freq. H} + \text{Freq. C} \\ &= 1.9 \times 20 + 1.0 \\ &= 39 \text{ Hz (It cuts down less than a decimal point)} \end{aligned}$$

Cooling & Soft Dry	XE9DK		XE12DK	
	Freq. A	Freq. C	Freq. A	Freq. C
Low Load (Freq. H ≤ 10)	0.9	11.0	0.9	11.0
High Load (Freq. H > 10)	1.9	1.0	1.9	0.7

Heating	XE9DK		XE12DK	
	Freq. A	Freq. C	Freq. A	Freq. C
Low Load (Freq. H ≤ 12)	1.4	10.6	1.4	10.6
High Load (Freq. H > 12)	2.2	1.0	2.1	1.8

Freq. Range		XE9DK	XE12DK
Cooling	Fc	39	52
	Operation Range	12 ~ 86	12 ~ 102
Heating	Fh	56	69
	Operation Range	14 ~ 128	14 ~ 128

Remarks:

When Freq. H is equal to 20 (XE9DK), 27 (XE12DK) for cooling, 25 (XE9DK), 32 (XE12DK) for heating or above, the Comp. may run at the freq. higher than Fc or Fh up to max. freq. operation.

Best Amenity Control

Every 90s (Cooling), 120s (Heating) maintain same zone Freq. H + 1 until Fc, Fh.

8.1.3. Cooling Operation

8.1.3.1. Thermostat control

- Compressor is OFF when Intake Air Temperature - Internal Setting Temperature < -1.5°C.
- Compressor is ON after waiting for 3 minutes, if the Intake Air Temperature - Internal Setting Temperature > Compressor OFF point.

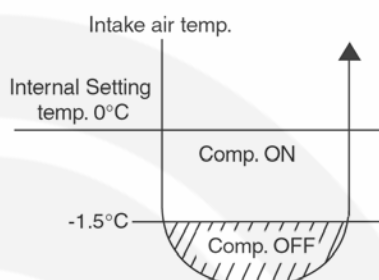

8.1.4. Soft Dry Operation

8.1.4.1. Thermostat control

- Compressor is OFF when Intake Air Temperature - Internal Setting Temperature < -2.5°C.
- Compressor is ON after waiting for 3 minutes, if the Intake Air Temperature - Internal Setting Temperature > Compressor OFF point.

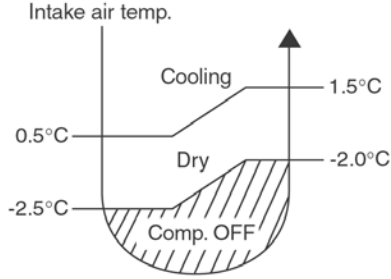

8.1.5. Heating Operation

8.1.5.1. Thermostat control

- Compressor is OFF when Intake Air Temperature - Internal Setting $\geq +1.0^\circ\text{C}$.
- Compressor is ON after waiting for 3 minutes, if the Intake Air Temperature - Internal Setting Temperature < Compressor OFF point.

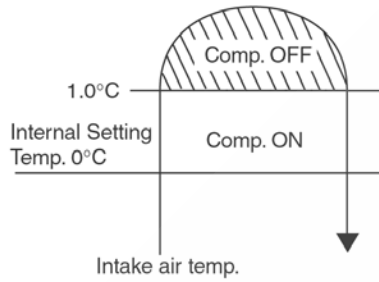

8.1.6. Automatic Operation

This mode can be set using remote control and the operation is decided by remote control setting temperature, indoor intake air temperature and outdoor air temperature.

During operation mode judgment, indoor fan motor (with speed of Lo-) and outdoor fan motor are running for 30 seconds to detect the indoor intake and outdoor air temperature. The operation mode is decided based on below chart.

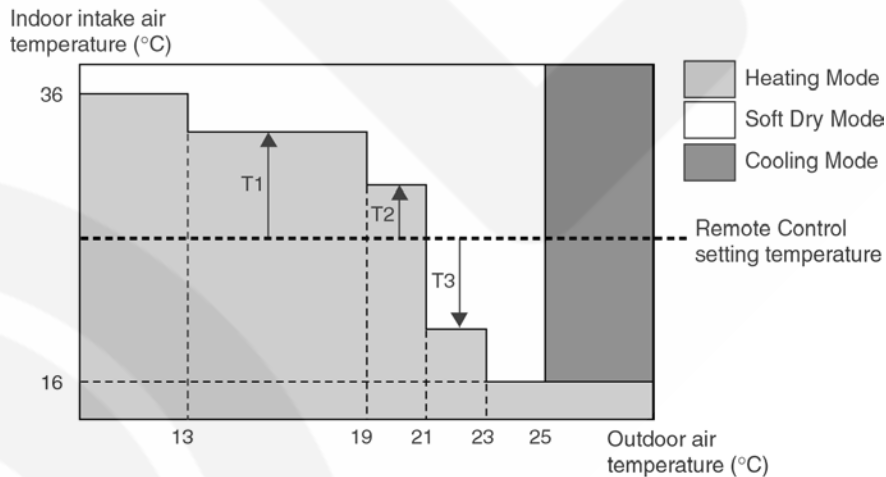

Values of T1, T2, and T3 depend on remote control setting temperature, as shown in below table. After the adjustment of T1, T2 and T3 values, the operation mode for that particular environment and remote control setting is judged and performed, based on the above operation mode chart, every 30 minutes.

Remote Control Setting Temperature (°C)	T1	T2	T3
16 ~ 18	+10	+8	-5
19 ~ 22	+8	+7	-7
23 ~ 26	+7	+6	-7
27 ~ 30	+6	+5	-8

There is a temperature shifting on T1, T2, and T3 if the operation mode judged is changed from Cooling/Soft Dry to Heating or vice versa.

Operation Mode change from	Temperature shifts (°C)
Cooling/Soft Dry → Heating	-2
Heating → Cooling/Soft Dry	+2

Example of operation mode chart adjustment:

From the above table, if remote control setting temperature = 25,

$T1 = 25 + 7 = 32$; $T2 = 25 + 6 = 31$; $T3 = 25 - 7 = 18$

The operation mode chart for this example is as shown in below figure and the operation mode to be performed will depend on indoor intake air temperature and outdoor air temperature at the time when the judgment is made.

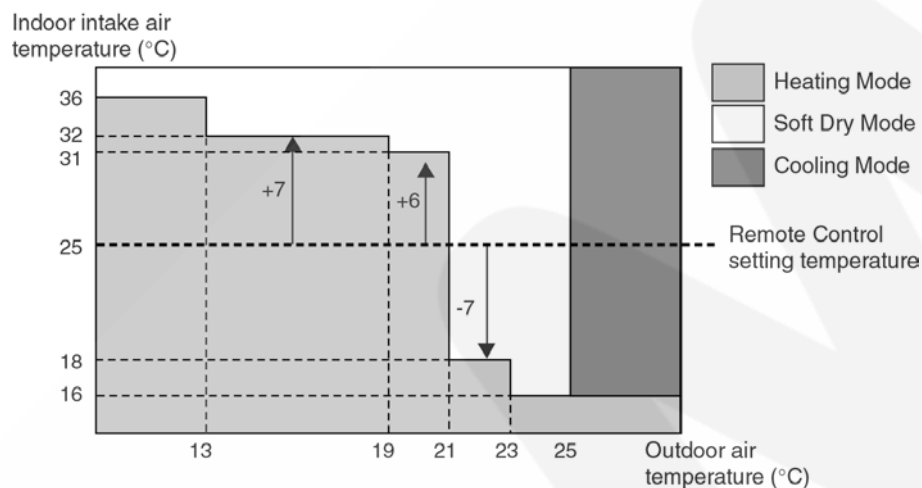

8.1.7. Indoor Fan Motor Operation

A. Basic Rotation Speed (rpm)

- Required rotation speed for fan is set to respond to the remote control setting (10 rpm unit)

[Cooling, Dry, Fan]

Remote Control	—	O	O	O	O	O	—	—	—
Tab (rpm)	SHI	Hi	Me+	Me	Me-	Lo	Lo-	SLo	SSLo
XE9DK	1250	1200	1100	1000	900	800	780	730	720
XE12DK	1340	1310	1200	1090	980	880	780	730	720

[Heating]

Remote Control	—	O	O	O	O	O	—	—	—
Tab (rpm)	SSHI	SHi	Me+	Me	Me-	Lo	Lo-	SLo	SSLo
XE9DK	1350	1270	1160	1050	940	840	790	730	720
XE12DK	1490	1410	1330	1250	1170	1100	840	730	720

B. Indoor Fan Control

i. Indoor fan control operation outline

1. Cooling / Dry / Fan / Ion / Oxygen

				Cooling	Dry	Fan, Ion only or O ₂ only	
Protected Operation				Me	—		
Forced Cooling Operation				Hi	—		
Other than above	Min. control	Auto Operation Mode judgement		Lo-		—	
		On timer pre-operation Sampling					
	Other than above	Max. capacity operation		SHi	—		
		Other than above	ON timer reserve operation	Auto Airflow	Lo		SLo
				Manual Airflow	Remote Control Setting		
		Other than above	Anti Freezing Control		+40 rpm		
	Other than above		Auto Airflow	Normal	Normal program		SLo
		Quiet		Quiet program			
		Manual Airflow	Quiet	-100 rpm refer to table	Quiet program		
			Normal	Remote Control setting	Remote Control setting		

2. Heating

Protected Operation				Me	
Force Heating Operation				SHi	
Min. control	Auto Operation Mode judgement			Lo-	
	On timer reserve Operation Sampling				
	Indoor piping temperature control			Me	
Other than above	During Hot Start			Stop	
	During De-ice			Stop	
	Low temp. capacity measurement			SSH i	
	Max. control	Thermo off (comp off)			Lo-
		Indoor piping temperature control (auto Fan Speed)			refer to Anti Cold Draft Control
	Other than above	ON timer standby operation	Auto Fan Speed		Lo-
			Manual Fan Speed		Remote Control Setting
		Other than above	Auto Fan Speed	Normal	refer to Anti Cold Draft Control
				Quiet	If FM ≥ Lo – 100 rpm shift If FM < Lo maintain current RPM
		Manual Fan Speed	Normal	refer to Anti Cold Draft Control	
Quiet			– 100 rpm shift		

ii. Auto Fan Speed

1. Cooling, Ion, Oxygen

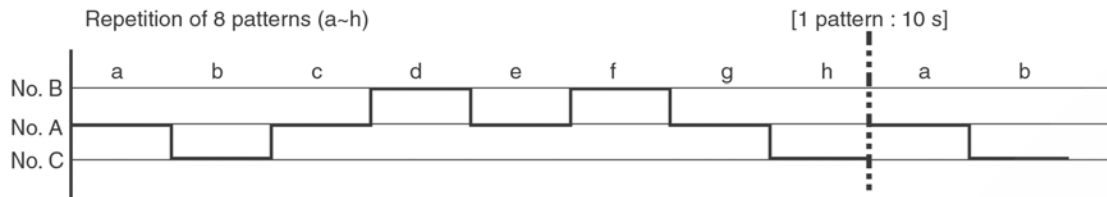

* At normal program air the data is justified as below.
 * And, No. B and No. C is calculated as following formula.

$$\text{No. A} = \text{WaC}$$

$$\text{No. B} = \text{WaC} + \text{W}\Delta\text{C}$$

$$\text{No. C} = \text{WaC} + \text{W}\Delta\text{C}$$

Unit : rpm								
	Model	Cool	Fan only	Ion, O ₂ only	No. A	No. B	No. C	WΔC
Normal Program	XE9DK	Yes	Yes	No	890	920	860	30
	XE12DK				940	970	910	
Quiet Program	XE9DK	Yes	No	Yes	790	820	760	30
	XE12DK				840	870	810	

Note: There is no Quiet operation for Fan, Ion & O₂ only operation. However the auto air volume of Ion & O₂ only operation follow the Quiet Program Air fan speed.

2. Heating

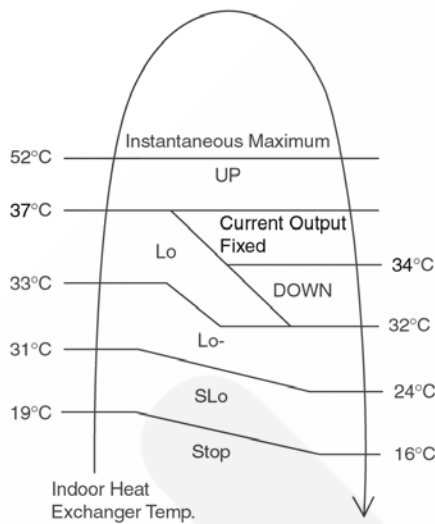

Note:

a. UP:

- If move from Lo, the fan speed will be shifted to Maximum 1160 rpm (XE9DK), 1330 rpm (XE12DK).
- If move from Maximum, the fan speed no change.
- In up zone, 10 rpm is added for every 10s until Maximum 1160 rpm (XE9DK), 1330 rpm (XE12DK).

b. DOWN:

- The fan speed will be decreased one step every 10 sec. until Minimum 840 rpm (XE9DK), 1100 rpm (XE12DK).

c. Current Output Fixed:

- Maintain at present fan speed.

d. Instantaneous Maximum:

- Fan speed will be increased to maximum auto fan speed.

iii. Max Capacity Condition

a) During Cooling operation, if all to the following condition is fulfilled, the indoor fan speed is set to Shi.

1. Indoor intake temperature $\geq 24^{\circ}\text{C}$.
2. Operation frequency 39 Hz (XE9DK), 52 Hz (XE12DK) & above.
3. Remote Control setting temperature 16°C .
4. Remote Control setting fan speed Hi.
5. Outdoor temperature $\geq 30^{\circ}\text{C}$.
6. Operation start \leq within 30 minutes.

* If any of above conditions is not valid, the condition is ended.

b) During Heating operation, if all to the following condition is fulfilled, the indoor fan speed is set to SSHi.

1. Indoor intake temperature is 17°C or above and less than 23°C .
2. Operation frequency 56 Hz (XE9DK), 68.5 Hz (XE12DK) & above.
3. Remote Control setting temperature 30°C .
4. Remote Control setting fan speed Hi.
5. Outdoor temperature $< 4^{\circ}\text{C}$.
6. Operation start ≥ 2 hours.

* If any of above conditions is not valid, the condition is ended.

C. Fan Motor Control

i. Motor specification

High voltage PWM Sensorless Motor

ii. Feedback Control

1. Rotation speed feedback

Immediately after the fan started, rpm is checked and duty is added, and feedback control is performed every 1s.

iii. Abnormal Detection

- | | |
|--------------|---|
| 1. Condition | * Step out signal input
* Feedback rotation speed is more than 2550 rpm or below 50 rpm.
However, 10s after fan start, rotation abnormality is not detected. |
| 2. Control | * Fan stop |
| 3. Return | * Restart after 5s
However, in case the fan is stopped by the above conditions within 25s after fan has started, and happened continuously for 7 times, restart will not be performed.
→ Indoor fan motor lock abnormal (H19) |

iv. Restart Prohibition Control

Prohibit to restart within 5s after fan stop.
(except when power is ON)

D. Deodorizing Control

i. Control condition

Control at cooling/dry operation and auto fan speed setting.

No Deodorizing Control is performed during ON timer standby operation and during Anti-freezing control prevention.

ii. Operation

The odor status is arranged as below and it is shifted as follow.

- * When COMP is ON 1 → 2 → 3
(Shift to 4 when COMP is OFF)
- * When COMP is OFF 4 → 5 → 4 ↔ 5
(Shift to 1 when COMP is ON)
- * Start from 4 if the Thermostat is OFF during the start operation.

Odor Status		1	2	3	4	5	4	5	4.5.4...	1	
Status Shift according to COMP		ON				OFF					ON
Status Shift according to time (s)	Cooling zone	40	50	—	20	90	20	90		
	Dry zone										
Fan Speed	Cooling zone	OFF	SLo	Auto Fan Speed	SLo	OFF	SLo	OFF		
	Dry zone	OFF		SLo		OFF		OFF			

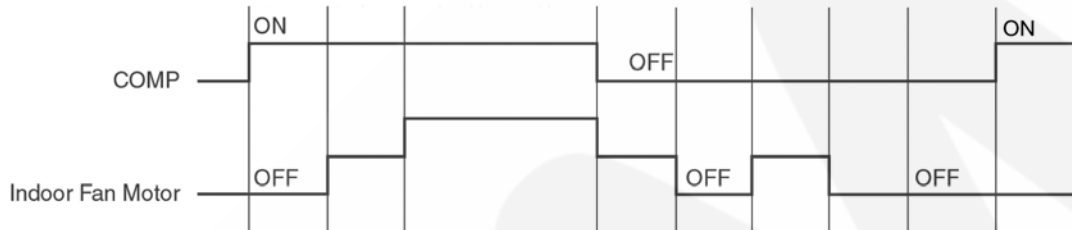

※ During FM OFF state, auto judgement will cause the FM to ON.

8.1.8. Outdoor Fan Motor Operation

- 6 pole induction, 1 speed 780 rpm (XE9DK), 810 rpm (XE12DK).
- It starts when compressor starts operation and it stops 30 seconds after compressor stops operation.

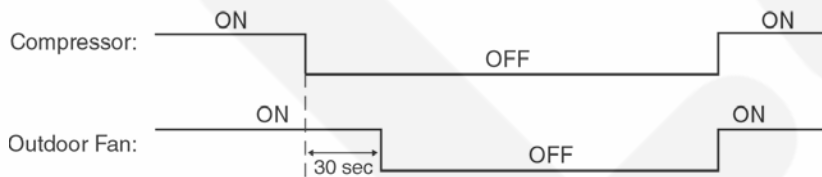

8.1.9. Airflow Direction

1. There are two types of airflow, vertical airflow (directed by horizontal vane) and horizontal airflow (directed by vertical vanes).
2. Control of airflow direction can be automatic (angles of direction is determined by operation mode, heat exchanger temperature and intake air temperature) and manual (angles of direction can be adjusted using remote control).

Vertical Airflow

Operation Mode	Airflow Direction	Vane Angle (°)				
		1	2	3	4	5
Heating	Auto with Heat Exchanger Temperature	17				
		58				
		7				
	Manual	7	17	33	49	67
Cooling, Soft Dry and Fan, Ion, O ₂	Auto	7 ~ 37				
	Manual	7	17	25	33	41
Mode Judgement in Auto	Auto	7				
	Manual	7	17	25	33	41

1. Automatic vertical airflow direction can be set using remote control; the vane swings up and down within the angles as stated above. For heating mode operation, the angle of the vane depends on the indoor heat exchanger temperature as Figure 1 below. When the air conditioner is stopped using remote control, the vane will shift to close position.

2. Manual vertical airflow direction can be set using remote control; the angles of the vane are as stated above and the positions of the vane are as Figure 2 below. When the air conditioner is stopped using remote control, the vane will shift to close position.

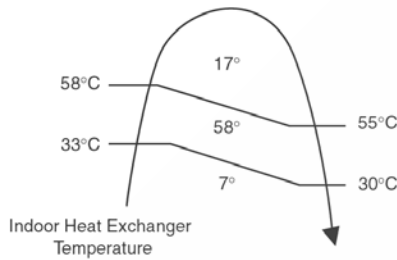

Figure 1

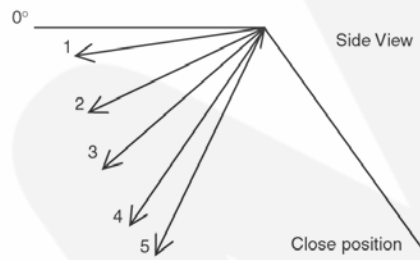

Figure 2

Horizontal Airflow

1. Automatic horizontal airflow direction can be set using remote control; the vane swings left and right within the angles as stated below. For heating mode operation, the angle of the vane depends on the indoor heat exchanger temperature as Figure 1 below.

Operation Mode		Vane Angle (°)
Heating, with heat exchanger temperature	A	55 ~ 125
	B	90
Cooling, Soft Dry and Fan, Ion, O ₂		55 ~ 125

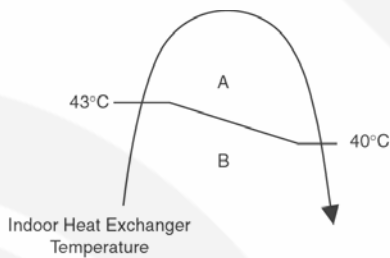

Figure 1

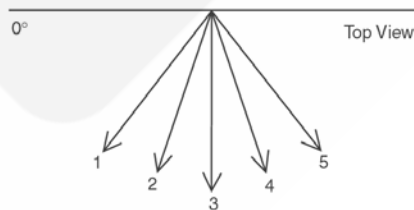
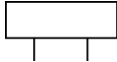
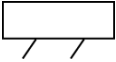
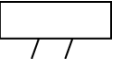
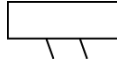
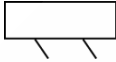

Figure 2

2. Manual horizontal airflow direction can be set using remote control; the angles of the vane are as stated below and the positions of the vane are as Figure 2 above.

Pattern	1	2	3	4	5
Airflow Direction Patterns at Remote Control					
Vane Angle (°)	90	55	70	110	125

8.1.10. Quiet operation (Cooling Mode/Cooling area of Dry Mode)

A. Purpose

To provide quiet cooling operation compare to normal operation.

B. Control condition

a. Quiet operation start condition

- When “quiet” button at remote control is pressed.

Quiet LED illuminates.

b. Quiet operation stop condition

1. When one of the following conditions is satisfied, quiet operation stops:

a. Quiet button is pressed again.

b. Stop by OFF/ON switch.

c. Timer “off” activates.

d. When change mode to fan only mode.

2. When quiet operation is stopped, operation is shifted to normal operation with previous setting.

3. When fan speed is changed, quiet operation is shifted to quiet operation of the new fan speed.

4. When operation mode is changed, quiet operation is shifted to quiet operation of the new mode, except fan only mode.

5. During quiet operation, if timer “on” activates, quiet operation maintains.

6. After off, when on back, quiet operation is not memorised.

C. Control contents

1. Fan speed is changed from normal setting to quiet setting of respective fan speed.

This is to reduce sound of Hi, Me, Lo for 3dB.

2. Fan speed for quiet operation is -100 rpm from setting fan speed.

8.1.10.1. Quiet operation under Soft Dry operation (Dry area at Dry Mode)

Automatic Fan Speed (Dry operation)

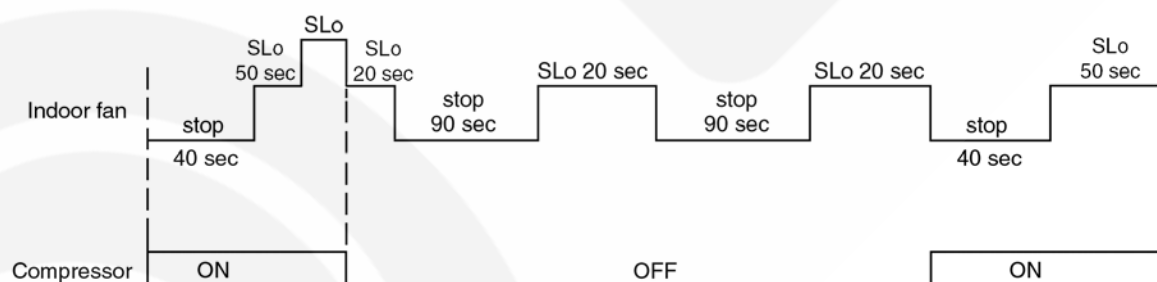

Manual Fan Speed (Dry operation)

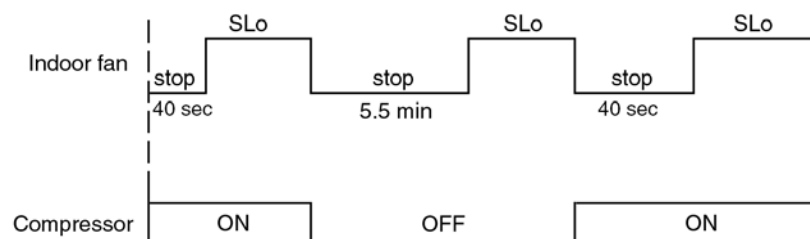

8.1.10.2. Quiet operation (Heating)

A. Purpose

To provide quiet heating operation compare to normal operation.

B. Control condition

a. Quiet operation start condition

- When “quiet” button at remote control is pressed.
Quiet LED illuminates.

b. Quiet operation stop condition

1. When one of the following conditions is satisfied, quiet operation stops:

- Quiet button is pressed again.
- Stop by OFF/ON switch.
- Timer “off” activates.
- When change mode to fan only mode.

2. When quiet operation is stopped, operation is shifted to normal operation with previous setting.

3. When fan speed is changed, quiet operation is shifted to quiet operation of the new fan speed.

4. When operation mode is changed, quiet operation is shifted to quiet operation of the new mode, except fan only mode.

5. During quiet operation, if timer “on” activates, quiet operation maintains.

6. After off, when on back, quiet operation is not memorised.

C. Control contents

a. Fan Speed manual

1. Fan speed is changed from normal setting to quiet setting of respective fan speed.

This is to reduce sound of Hi, Me, Lo for 3dB.

2. Fan speed for quiet operation is -100 rpm from setting fan speed.

3. Fan Speed Auto

- If $FM \geq Lo$
-100 rpm reduce from normal Heating Auto Fan Speed
- If $FM < Lo$
maintain RPM

Indoor FM RPM depends on pipe temp sensor of indoor heat exchanger.

8.1.11. Delay ON Timer Control

Delay ON timer can be set using remote control, the unit with timer set will start operate earlier than the setting time. This is to provide a comfortable environment when reaching the set ON time.

Seventy minutes before the set time, indoor (at fan speed of Lo-) and outdoor fan motor start operate for 30 seconds to determine the indoor intake air temperature and outdoor air temperature in order to judge the operation starting time.

From the above judgment, the decided operation will start operate earlier than the set time as shown below.

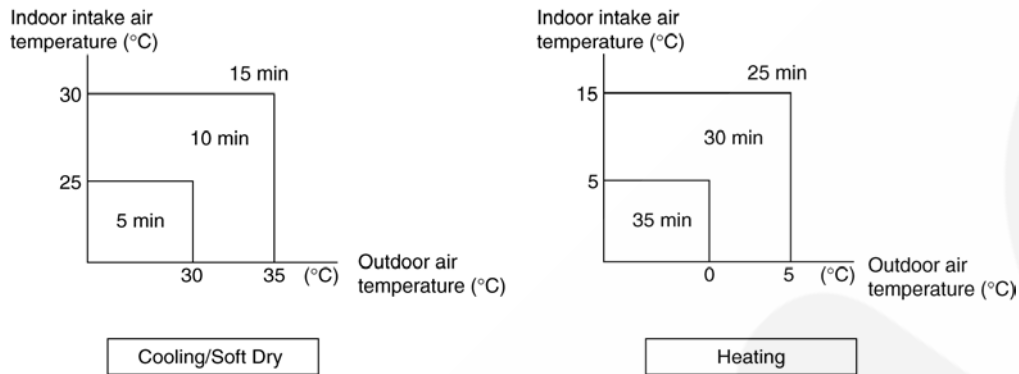

8.1.12. Delay OFF Timer Control

Delay OFF timer can be set using remote control, the unit with timer set will stop operate at set time.

8.1.13. Auto Restart Control

1. When the power supply is cut off during the operation of air conditioner, the compressor will re-operate within three to four minutes (there are 10 patterns between 2 minutes 58 seconds and 3 minutes 52 seconds to be selected randomly) after power supply resumes.
2. This type of control is not applicable during ON/OFF Timer setting.

8.1.14. Auto Operation Switch

Number of "beep":	1	2	3	4
Function:	Auto Operation	Forced Cool	Forced Heat	Various Setting Mode
Duration (s):	0	5	8	11
			16	21

1. When the switch is pressed between 0 to 5 seconds, Auto Mode operation starts to function.
2. When the switch is pressed between 5 to 8 seconds, the unit is forced to operate in Cooling Mode.
3. When the switch is pressed between 8 to 11 seconds, the unit is forced to operate in Heating Mode.

4. When the switch is pressed between 11 to 16 seconds and together with the signal from remote control, the unit can be changed to different controlling setting (A-B mode) or to testify oxygen operation.
5. When the switch is pressed between 16 to 21 seconds, either "H14" error detection selection mode or the remote control signal receiving sound can be cancelled or turned on.

8.1.15. Indoor Power Relay Control

Power relay will turn on during operation or in progress of stopping operation. Although operation stops, the power relay continues on for three minutes.

However, during an instantaneous power failure (< 0.5s), power relay will turn off. Then, it will turn on 2 minutes after power recover and the unit will operate as previous operation condition.

8.1.16. Ionizer Operation

Purpose

To provide fresh air effect to users by discharging minus ion to air.

Control Condition

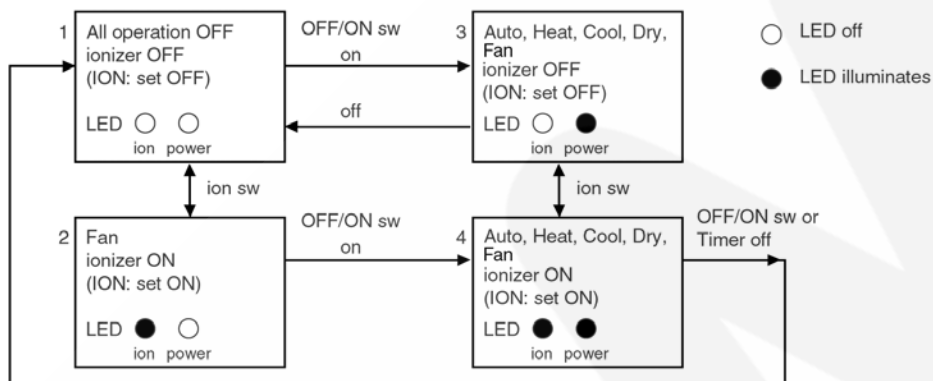

a. Ionizer Only Operation.

1. When an air-conditioner unit is at "OFF" condition (standby) and an ION operation button at remote control is pressed. Fan & ionizer on, ION LED illuminates, but power LED maintain off. (1 → 2)
However, fan speed can be adjusted later by customer during this operation.

Fan speed	
manual	Remote Control set fan speed
Auto	Repetition of 8 patterns as shown below

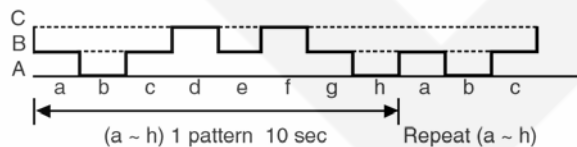

Airflow direction (Horizontal Vane) control:

Follow vane direction control at cooling mode.

Horizontal vane can be changed by customer during ion only operation.

b. Operation Mode + Ionizer Operation.

1. Ionising Operation Start Condition

When an air conditioner unit is in "ON" condition (Heat, Cool, Dry, Fan, Auto mode) and an ION operation button at remote

control is pressed. Ionizer on & ION LED illuminates. (3 → 4)
Power LED also illuminates.

2. Ionising Operation Stop Condition

When one of the following condition is satisfied, ION operation stops.

- a. Stopped by ON/OFF switch.
- b. Timer OFF activates.
- c. ION operation button is pressed again.
- d. ION feedback signal shows error.

3. Ionizer operation status is not memorised by micon. After OFF, when operation is “ON” again, air conditioner operates without ionizer operation.

c. Timer during ionizer operation

Refer to case study in next page for detail.

8.1.16.1. Ionizer Problem Detection Control

i. Purpose

To inform user of ionizer problems and detection.

ii. Two types of problem detection control:

Control	Detection Method	Protection	Recovery
<p>ERROR PROTECTION</p> <p>(i) Actual ion: ON</p> <p>(ii) ion feedback signal: 0V</p>	<p>(i) Actual ion ON for 10s & OFF for 30 min. continuously for 24 times (approx. 11 hr. 30 min.)</p> <p>(ii) Within 24 counts, if anytime CONDITION becomes false then count is cleared.</p>	<p>(i) Actual ion is permanently OFF & ion LED is blinking.</p> <p>(ii) Press remote control ion button for a) ON: Ion LED blink & buzzer = beep b) OFF: Ion LED OFF & buzzer = beep</p>	<p>(i) Press ON/OFF button to OFF</p> <p>(ii) Reset power</p> <p>(iii) Off by force operation</p>
<p>BREAKDOWN PROTECTION</p> <p>(i) Actual ion: OFF</p> <p>(ii) ion feedback signal: 5V</p>	<p>(i) Actual ion OFF $\geq 2s$</p>	<p>Case 1: During Air-Con. ON.</p> <p>(i) Air-Cond OFF with abnormal no. H26 is activated with timer LED is blinking permanently.</p> <p>Case 2: During Air-Con. OFF.</p> <p>(i) Abnormal no. H26 is activated with timer LED is blinking permanently for both cases 1 & 2.</p> <p>(ii) Press remote control ion button for a) ON: Ion LED blink b) OFF: Ion LED OFF</p> <p>(iii) Press any remote control button to a) ON: Buzzer = beep beep beep beep b) OFF: Buzzer = beep beep beep beep</p>	<p>(i) When anytime CONDITION becomes false.</p> <p>(ii) Once recovered, ion & Timer LED stops blinking permanently.</p> <p>(iii) Main power reset.</p>

8.1.16.2. Ionizer Operation case study

Case 1

Current Operation \ Timer		24 hours Timer	
		Set to ON	Set to OFF
ION	ON	Continue ON	Stop
	OFF	Not Applicable (*2)	Continue OFF
Operation Any Mode (*1)	ON	Continue ON	Stop
	OFF	Start	Stop

*1. Heat, Cool, Dry, Fan and Auto.

*2. You may ON by pressing Ion button.

8.2. Protection Control Features

8.2.1. Protection Control For All Operations

8.2.1.1. Time Delay Safety Control

1. The compressor will not start for three minutes after stop of operation.
2. This control is not applicable if the power supply is cut off and on again or after 4-way valve deices condition.

8.2.1.2. 30 Seconds Forced Operation

1. Once the compressor starts operation, it will not stop its operation for 30 seconds.
2. However, it can be stopped using remote control or Auto Switch at indoor unit.

8.2.1.3. Total Running Current Control

1. When the outdoor unit total running current (AC) exceeds X value, the frequency instructed for compressor operation will be decreased.
2. If the running current does not exceed X value for five seconds, the frequency instructed will be increased.
3. However, if total outdoor unit running current exceeds Y value, compressor will be stopped immediately for three minutes.

Operation Mode	XE12DK		XE9DK	
	X (A)	Y (A)	X (A)	Y (A)
Cooling/Soft Dry (A)	6.5	17.0	4.5	17.0
Cooling/Soft Dry (B)	6.0	17.0	4.0	17.0
Heating	9.2	17.0	6.1	17.0

4. The first 30 minutes of cooling operation, (A) will be applied.

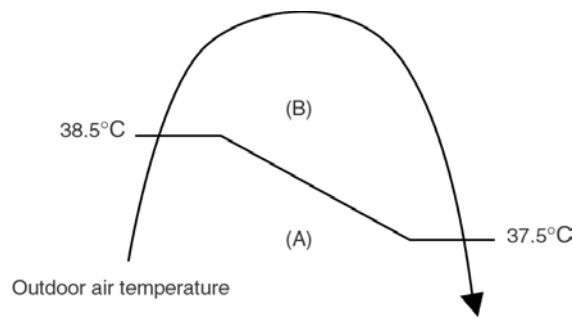

8.2.1.4. IPM (Power transistor) Prevention Control

A. Overheating Prevention Control

1. When the IPM temperature rises to 110°C, compressor operation will stop immediately.
2. Compressor operation restarts after three minutes the temperature decreases to 95°C.

B. DC Peak Current Control

1. When electric current to IPM exceeds set value of 22.5 ± 4.0 A, the compressor will stop operate. Then, operation will restart after three minutes.
2. If the set value is exceeded again more than 30 seconds after the compressor starts, the operation will restart after 1 minute.
3. If the set value is exceeded again within 30 seconds after the compressor starts, the operation will restart after one minute. If this condition repeats continuously for seven times, all indoor and outdoor relays will be cut off.

8.2.1.5. Compressor Overheating Prevention Control

Instructed frequency for compressor operation will be regulated by compressor top temperature. The changes of frequency are as below figure.

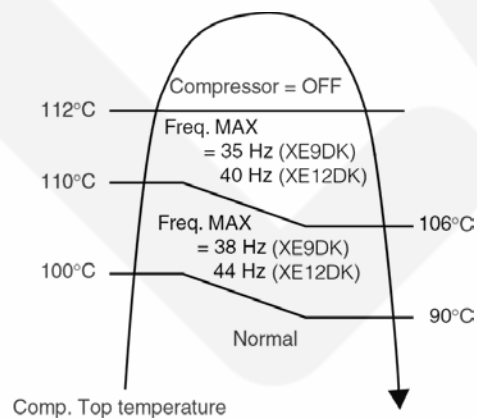

8.2.1.6. Low Pressure Prevention Control (Gas Leakage Detection)

1. When the conditions listed in below table occur, the compressor stops and restarts after three minutes.
2. If this phenomenon is continuously occurring for twice within 20 minutes, all indoor and outdoor relays will be cut off.
3. This control is not applicable for deice operation.

Conditions	XE9DK		XE12DK	
	Cooling/Soft Dry	Heating	Cooling/Soft Dry	Heating
1. Compressor frequency (Hz)	≥ 47	≥ 56	≥ 67	≥ 69
2. Outdoor total running current (A)	< 1.21	< 1.21	< 1.21	< 1.21
3. Indoor heat exchanger temperature ($^{\circ}\text{C}$)	≥ 20	< 25	≥ 20	< 25

Note: Conditions 1 and 2 needed to be happened continuously for 5 minutes.

8.2.1.7. CT Disconnection Detection

1. Control Starting Condition
 - a. Total Current is below 0.63 Amp.
 - b. Operating Frequency is 20 Hz and above.
 - c. Continuously for 20s.
2. Control Contents
 - a. Abnormal signal transmitted to indoor unit after 3 minutes outdoor power is supplied. (Indoor unit stop)
3. Control Cancellation Condition

Starting condition, (1) is not fulfilled.

8.2.1.8. Low Frequency Protection Control 1

When the compressor operate at frequency lower than 26 Hz (XE9DK), 28 Hz (XE12DK) for 240 minutes, the operation frequency will be increased to 26 Hz (XE9DK), 28 Hz (XE12DK) for two minutes.

8.2.1.9. Low Frequency Protection Control 2

When all the below conditions occur, minimum value (Freq. MIN) for the frequency instructed to compressor will change to 30 Hz (XE9DK), 32 Hz (XE12DK) for cooling and 21 Hz (XE9DK), 21 Hz (XE12DK) for Heating.

Temperature, T, for:	Cooling/Soft Dry	Heating
Indoor intake air ($^{\circ}\text{C}$)	$T < 15$ or $T \geq 30$	-
Outdoor air ($^{\circ}\text{C}$)	$T < 16$ or $T \geq 38$	$T < 4$ or $T \geq 24$
Indoor heat exchanger ($^{\circ}\text{C}$)	$T < 30$	$T \geq 0$

8.2.2. Protection Control For Cooling & Soft Dry Operation

8.2.2.1. Outdoor Air Temperature Control

The compressor operating frequency is regulated in accordance to the outdoor air temperature as shown in the diagram below.

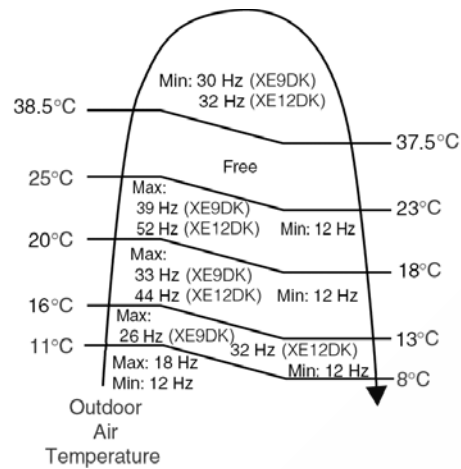

8.2.2.2. Cooling Overload Control

i. Pipe temperature limitation/restriction

- Detects the Outdoor pipe temperature and carry out below restriction/limitation (Limit the compressor Operation frequency)
- The compressor stop if outdoor pipe temperature exceeds 62°C
- If the compressor stops 4 times in 20 minutes, Timer LED blinking (F95: outdoor high pressure rise protection)

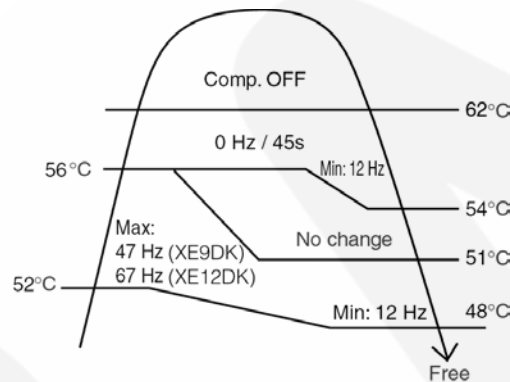

8.2.2.3. Anti-Freezing Control

1. When indoor heat exchanger temperature is lower than 2°C continuously for six minutes, compressor will stop operating.
2. Compressor will resume its operation three minutes after the indoor heat exchanger is higher than 10°C.
3. At the same time, indoor fan speed increase +40 rpm compared to its normal operation.
4. If indoor heat exchanger temperature is higher than 10°C for five minutes, the fan speed will return to its normal operation.

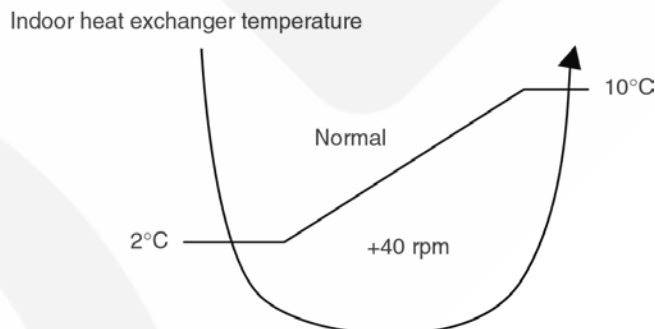

8.2.2.4. Anti-Dew Formation Control

Anti-Dew control is performed if the following conditions are fulfilled during cooling/dry operation.

a. Control Start Condition

- | | |
|---------------------------------------|--------------------------|
| 1) Indoor Intake Air Temperature | 24°C & above |
| 2) Outdoor Air Temperature | Refer below |
| 3) Remote Control Setting Temperature | 16°C & above, below 30°C |
| 4) Fan tab | Refer below |

Control start after 1) ~ 4) continued for more than 1 minutes.

b. Control Contents

- * If the outdoor temperature $\geq 30^\circ\text{C}$
Me & above (include auto air flow)

	XE9DK	XE12DK
$0 \text{ min} \leq T < 30 \text{ min}$	47	67
$30 \text{ min} \leq T < 90 \text{ min}$	39	52
$90 \text{ min} \leq T < 420 \text{ min}$	39	52

Below Me

	XE9DK	XE12DK
$0 \text{ min} \leq T < 30 \text{ min}$	33	44
$30 \text{ min} \leq T < 90 \text{ min}$	26	36
$90 \text{ min} \leq T < 420 \text{ min}$	26	36

- * If the outdoor temperature $< 30^\circ\text{C}$
Me & above (include auto air flow)

	XE9DK	XE12DK
$0 \text{ min} \leq T < 30 \text{ min}$	47	67
$30 \text{ min} \leq T < 90 \text{ min}$	39	52
$90 \text{ min} \leq T < 420 \text{ min}$	39	52

Below Me

	XE9DK	XE12DK
$0 \text{ min} \leq T < 30 \text{ min}$	33	44
$30 \text{ min} \leq T < 90 \text{ min}$	26	36
$90 \text{ min} \leq T < 420 \text{ min}$	26	36

c. Cancellation Condition

- Perform cancellation within 420 minutes after start and return to initial control.
- When changing the remote control setting temperature or air flow setting during the Anti-Dew control operation.
- If the above starting condition is not fulfilled.

8.2.3. Protection Control For Heating Operation

8.2.3.1. Anti Cold Draft Control

Indoor fan speed varies in accordance to indoor heat exchanger temperature, based on type of air volume and direction, as shown below.

1. Manual Fan Speed

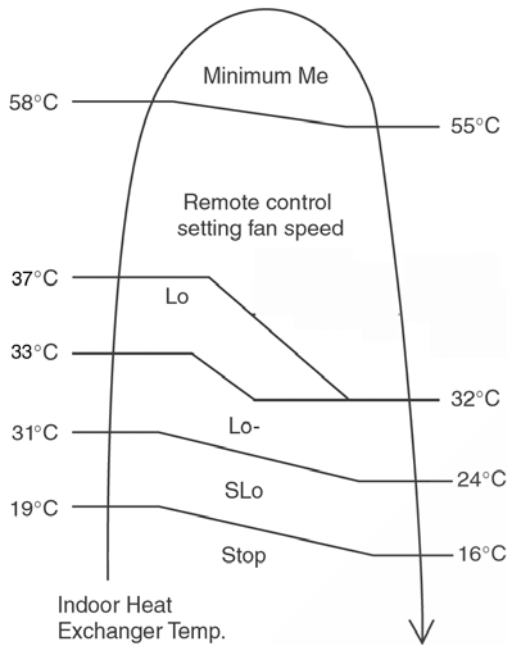

Auto Airflow Direction

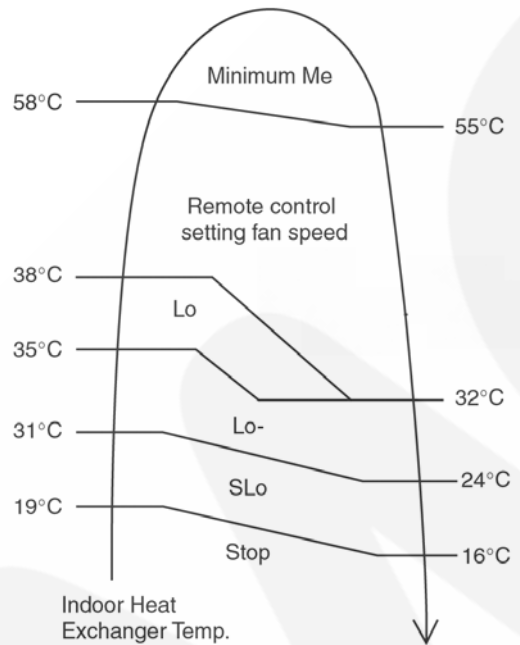

Manual Airflow Direction

2. Auto Fan Speed

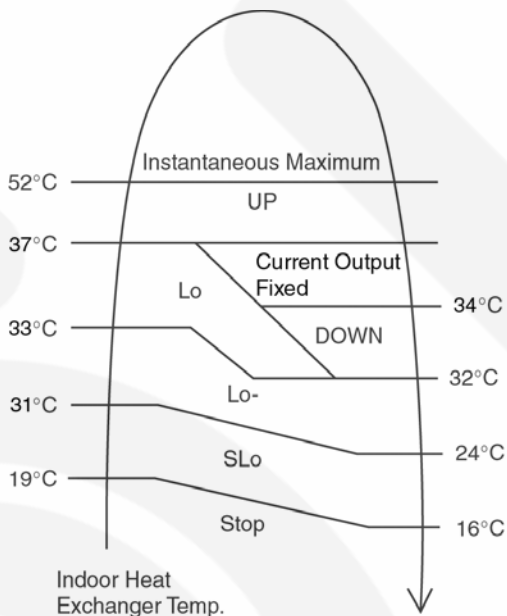

Auto Airflow Direction

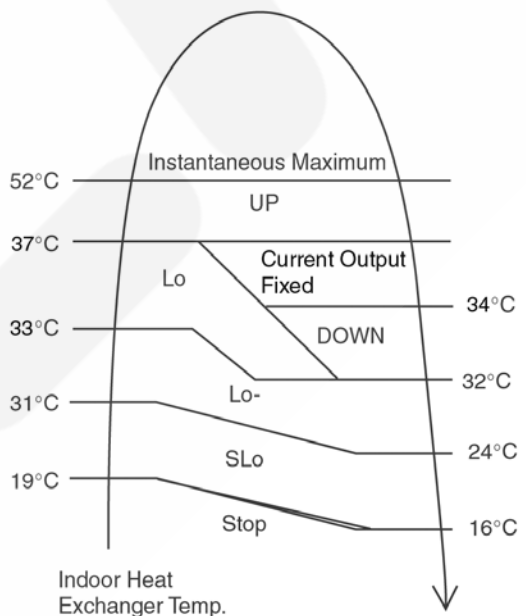

Manual Airflow Direction

Note:

a. UP:

- If move from Lo, the fan speed will be shifted to Maximum 1160 rpm (XE9DK), 1330 rpm (XE12DK).
- If move from Maximum, the fan speed no change.
- In up zone, 10 rpm is added for every 10s until Maximum 1160 rpm (XE9DK), 1330 rpm (XE12DK).

b. DOWN:

- The fan speed will be decreased one step every 10 sec. until Minimum 840 rpm (XE9DK), 1100 rpm (XE12DK).

c. Current Output Fixed:

- Maintain at present fan speed.

d. Instantaneous Maximum:

- Fan speed will be increased to maximum auto fan speed.

8.2.3.2. Intake Air Temperature Control

Compressor will operate at maximum of 56 Hz (XE9DK), 69 Hz (XE12DK) respectively if either one of the below conditions occur:

1. When the indoor intake air temperature is above 10°C and remote control setting fan speed is lower Me-.
2. When the indoor intake air temperature is 30°C or above.

8.2.3.3. Outdoor Air Temperature Control

The compressor operating frequency is regulated in accordance to the outdoor air temperature as shown in the below figures. This control will begin one minute after the compressor starts.

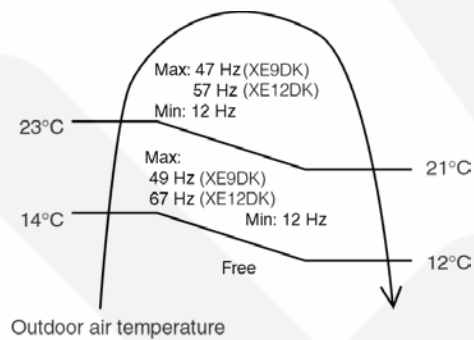

8.2.3.4. Overload Protection Control

The compressor operating frequency is regulated in accordance to indoor heat exchanger temperature as shown in below figures.

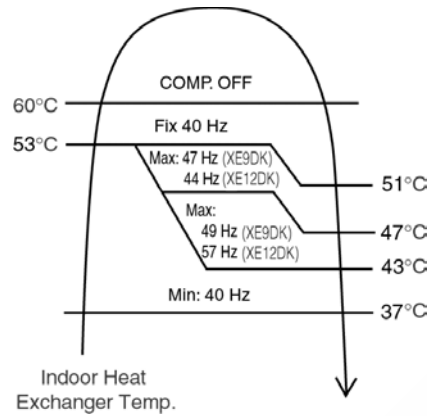

8.2.3.5. Preliminary Operation Control

1. Purpose

To improve heating cool start characteristic in which compared to previous model, achieved 40°C of discharge air in shorter time.

2. Detection method

- a. OD air temperature sensor
- b. ON timer = ON
- c. Control by OD PCB preliminary operation mode ON/OFF jumper wire

3. Preliminary operation control judgement condition

- a. Preliminary operation start when all below condition is fulfilled.
 - i. Air-conditioner is stop
 - ii. OD air temp < -15°C
 - iii. ON Timer is set to ON
- b. Either one of below condition is true, the preliminary operation is stopped.
 - i. Air-conditioning is running
 - ii. OD air temp ≥ -10°C
 - iii. Compressor operation started

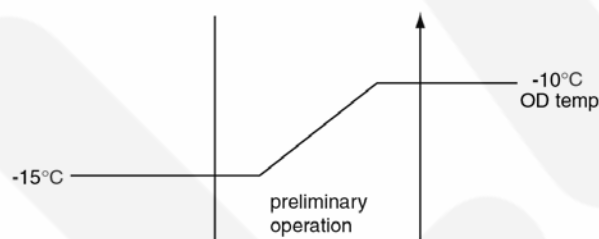

4. Control method

- a. Control start α min before the On Timer set time.
- b. Compressor motor winding temp is increase by applying small amount of current with uncomplete power phase
- c. Repetition of 1 min ON & 4 min OFF.

	α
time (min)	60



8.2.3.6. Deice Control

A. Deice operation (Normal Deice Operation)

1. Detection methods

Outdoor heat exchanger temperature sensor, timer.

2. Deice operation time chart

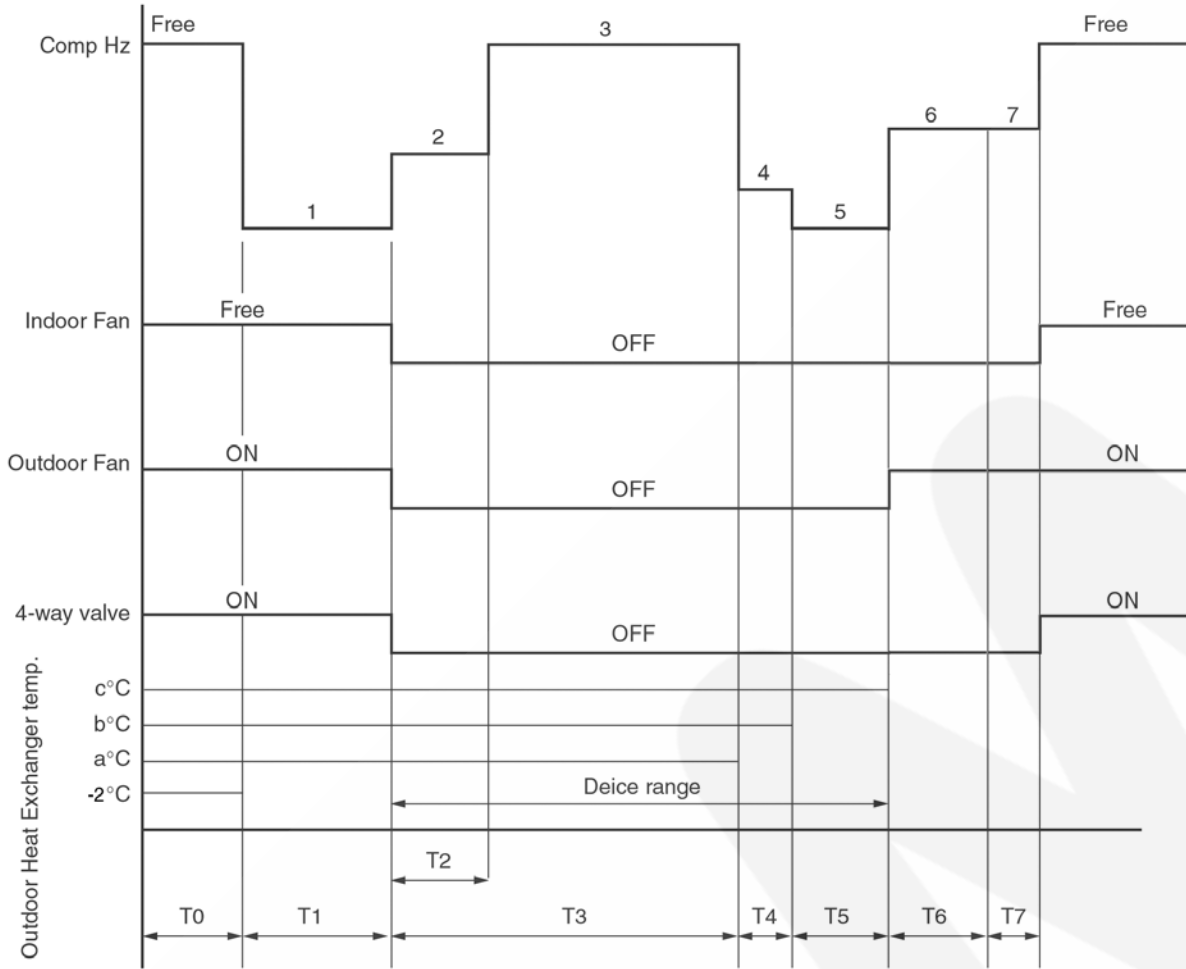

Notes

- a. During deice operation, the relationship between outdoor pipe temperature and time T5 is such operation will proceed to next stage.
- b. The deice will be performed only after 1 hour from when the operation has started.
- c. When Comp. OFF by the sequence No. 1~7 compressor can restart back without 3 minutes waits (immediate restart).

Sequence range	1	2	3	4	5	6	7	
Time	30 s	30 s	max 10 min. 30 s		max: 30 s	59 s	0 s	
Frequency (Hz)	XE9DK	0	47	58	35	35	0	0
	XE12DK	0	62	67	40	40	0	0
Indoor fan	Free	OFF	OFF	OFF	OFF	OFF	OFF	
Outdoor fan	ON	OFF			OFF	ON	ON	
4-way valve	ON	OFF			OFF	OFF	OFF	

Outdoor heat exchanger temperature

a	15°C
b	18°C
c	25°C

3. Explanation of operation

- 1) Before the deice is started, compressor frequency is set to the specified value for T1-timer.
- 2) After deice is started, the 4-way valve, OD Fan and ID fan are OFF.
- 3) After 4-way valve is OFF for 30 s, compressor frequency is set to the specified value.
- 4) Before deice is ended, if the outdoor heat exchanger temperature exceeds a°C, set compressor frequency and expansion valve to the specified values.
- 5) When outdoor heat exchanger temperature exceeds b°C, or 10 minutes has passed since the 4-way valve is OFF, operation at timer T5 will be started.
- 6) After the above 5) operation, if the outdoor heat exchanger temperature exceeds C°C, or after timer T5, the deice operation ending signal will be produced. The comp. Hz is set to the specified value and at the same time outdoor fan motor ON signal is produced.
- 7) After T6 the deice ending signal is produced, 4-way valve is set to ON, indoor fan is ON, Compressor frequency is FREE, and return to normal heating operation.

4. Deice operation judgement condition

When any of below a, b, c, d condition is satisfied, deice signal is produced.

- a. Continuously, outdoor heat exchanger temperature < 3°C for 120 minutes and outdoor heat exchanger temperature < -6°C for 3 minutes and outdoor air temperature > -1°C and Comp. is ON.
- b. Continuously, outdoor heat exchanger temperature < 3°C for 80 minutes and outdoor heat exchanger temperature < -7°C for 3 minutes and outdoor air temperature > -1°C and Comp. is ON.
- c. Continuously, outdoor heat exchanger temperature < 3°C for 40 minutes and outdoor heat exchanger temperature < -9°C and outdoor air temperature > -3°C for 3 minutes and Comp. is ON.
- d. Continuously, outdoor heat exchanger temperature < 3°C for 40 minutes and outdoor heat exchanger temperature < -11°C for 3 minutes and outdoor air temperature < -3°C and Comp. is ON.

However, the first deice will start only after minimum of 60 minutes in operation.

(2nd deice and onward shall follow above conditions)

8.3. Oxygen Enrich Operation

8.3.1. Purpose

Increase usage range by enable oxygen enrichment only operation.

8.3.2. Oxygen Enrichment Control -1

A. Indoor fan control

1. Air flow volume manual

Air flow volume as set by remote control. Speed same as for Cool mode.

2. Air flow volum auto

Repetition of 8 pattern (a ~ h) as shown below.

Each pattern, 10s

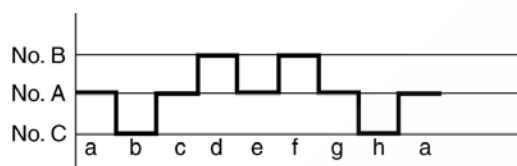

$$\begin{aligned} \text{Fan No. A} &= W \alpha C \\ \text{No. B} &= W \alpha C + W \Delta C \\ \text{No. C} &= W \alpha C - W \Delta C \end{aligned}$$

		XE9DK	XE12DK
Quiet Program Air	No. B	820	870
	No. A	790	840
	No. C	760	810
	$W \Delta C$	30	30

However, if combined operation with other mode, priority is given to fan control of other mode.

Priority: Cool - Dry - Fan - Heat > Ionizer > Oxygen

B. Indoor air direction control

1. Air flow direction manual, auto → same as cooling operation.

However when combined operation with other mode, priority is given to air flow direction control of other mode.

Priority Heat - Cool - Dry - Fan > Ionizer > Oxygen

C. Start & Cancel condition of Oxygen enrich operation

1. By remote control ON/OFF button.

- During Ionizer and Air Conditioner is OFF, if Oxygen button is pressed
→ Oxygen only operation.
- During Ionizer only operation, if Oxygen button is pressed
→ Ionizer + Oxygen enrich operation.
- During Oxygen only operation, If Oxygen button is pressed
→ Oxygen operation stop.
- During Oxygen only operation, if ON/OFF button is pressed
→ Mode (as remote control setting) operation + Oxygen operation.
- During Cool, Fan, Heat, Dry, Ionizer operation, if Oxygen button is pressed
→ Cool, Fan, Heat, Dry, Ionizer + Oxygen operation, if Oxygen button is pressed.
- During Cool, Fan, Heat, Dry, Ionizer + Oxygen operation, if Oxygen button is pressed.
→ Cool, Fan, Heat, Dry, Ionizer operation.
- During Cool, Fan, Heat, Dry, Ionizer + Oxygen operation, if ON/OFF button is pressed
→ All operation stop.

2. When operate together with ON/OFF timer.
 - a. ON timer is set during operation stop.
Previous operation is Oxygen only,
→ Previous mode (Auto, Heat, Cool, Dry, Fan) only will operate.
 - b. ON timer is set during Oxygen only operation.
→ Previous mode (Auto, Heat, Cool, Dry, Fan) + Oxygen will operate.
 - c. OFF timer during Oxygen only operation.
→ Oxygen operation stop.
 - d. There is no preliminary operation for Oxygen enrich operation.

3. Remote control setting during Oxygen only operation.
 - Remote control setting is acceptable during oxygen only operation.

D. Oxygen monitor indication

During oxygen enrich operation, oxygen monitor LED lights ON.

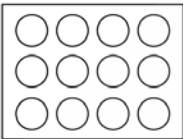
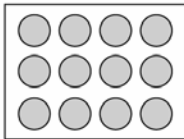
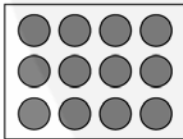
Part	Operation OFF	Operation ON	Delay Stop
LED indicator	 <p>Light Off</p>	 <p>Light On</p>	 <p>Blinking</p>

- Oxygen LED lights is ON or OFF when Oxygen operation is set to ON or OFF regardless of outdoor oxygen supply level. In case of indoor unit is totally stop and vacuum pump is still running (during delay stop operation) oxygen LED is blinking (ON 1s - OFF 1s).

8.3.3. Oxygen Enrich Control -2

A. Oxygen enrich system

1. Indoor intake air temp sensor
2. Indoor oxygen discharge hole
3. Remote control
4. Oxygen LED
5. Connecting hose
6. Vacuum pump
7. Pump discharge hole
8. Pump suction hole
9. Pump motor cooling fan A
10. Pump motor cooling fan B
11. Pump motor OLP
12. 2 way valve
13. Pressure reduction device
14. Odor filter
15. Oxygen enrich membrane
16. Outdoor air temp sensor
17. Outdoor oxygen discharge hole
18. Outdoor fan motor

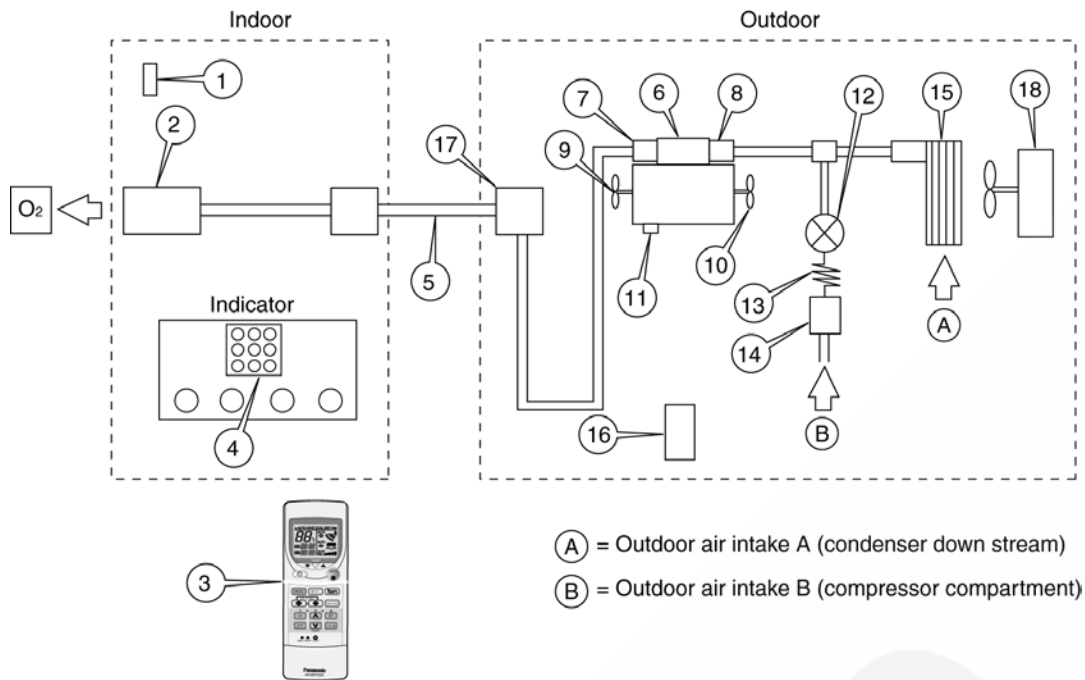

B. Oxygen enrich control overview

Upon receiving ON signal from indoor unit, the outdoor vacuum pump, fan & 2 way valve will operate according to the various protection control setting.

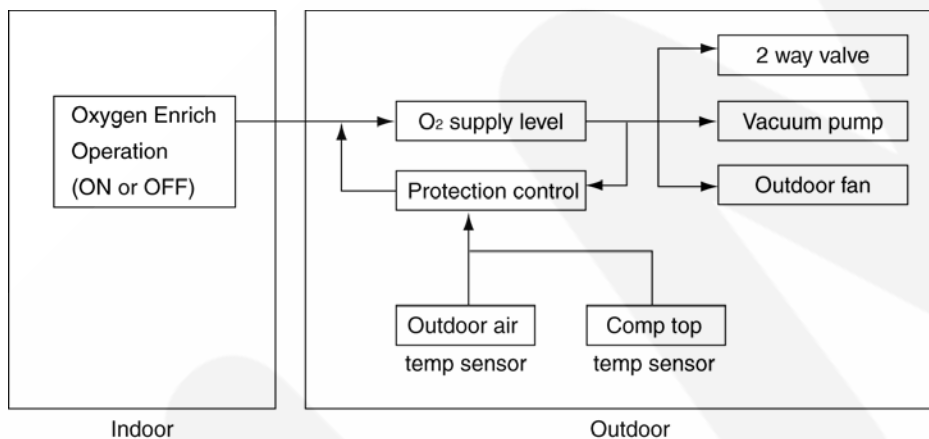

C. Oxygen enrich protection control (O₂ supply level judgement)

1. Vacuum pump protection

- Base on outdoor air temp., Comp. top temp., the oxygen supply level is decided.
- Priority is given to the lower level.
- Vacuum pump operation cycle time = EOPMPS01.
- O₂ supply level change only after vacuum pump ON/OFF operation completed 1 cycle time if the new level is higher than the present level.
- O₂ supply level change immediately if the new level is lower than the present level (avoid O₂ supply level hunting).
- Vacuum pump operate with ON/OFF timing according to O₂ supply level except during continuous running required by freeze-up prevention control (F-2).

E.g. Oxygen supply level change timing (vacuum pump continuous running control, (C-2) not yet activated).

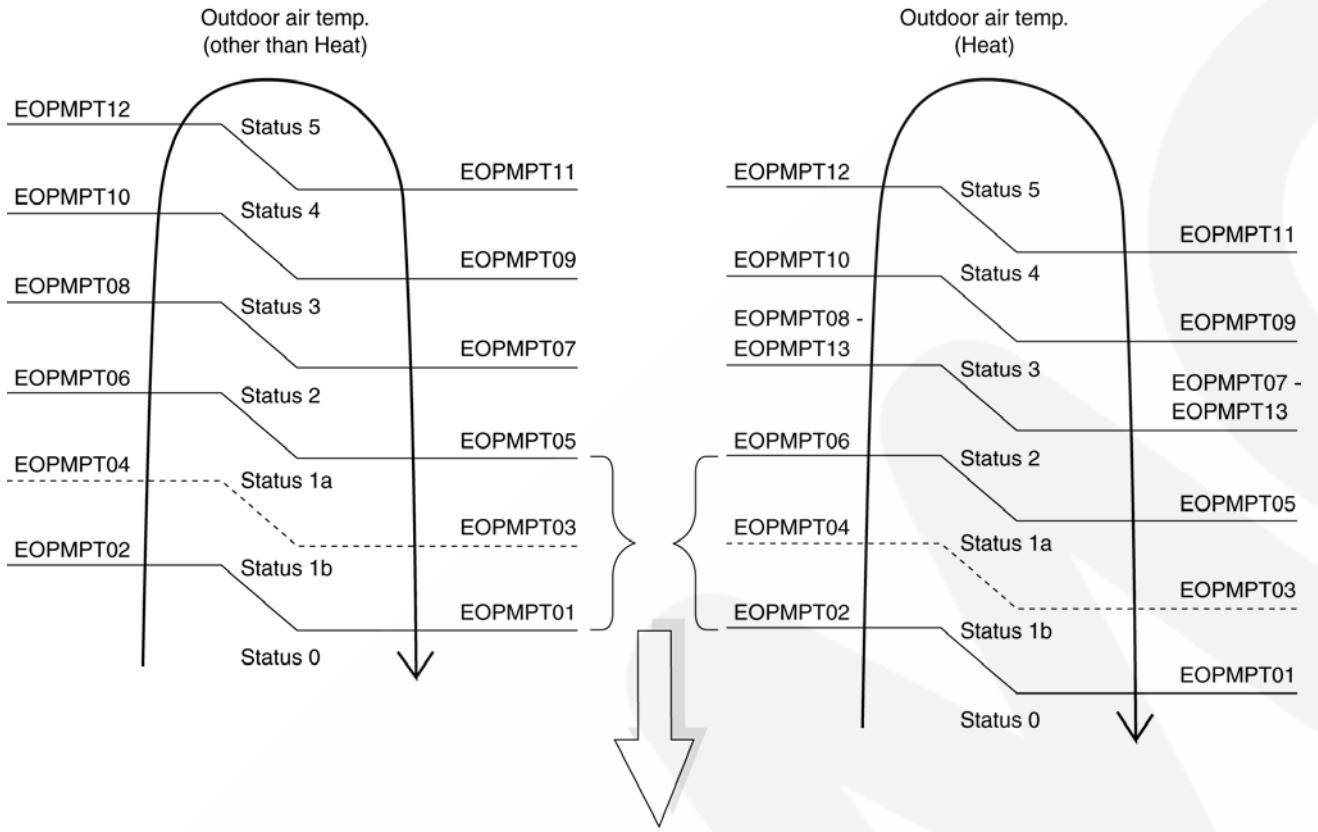
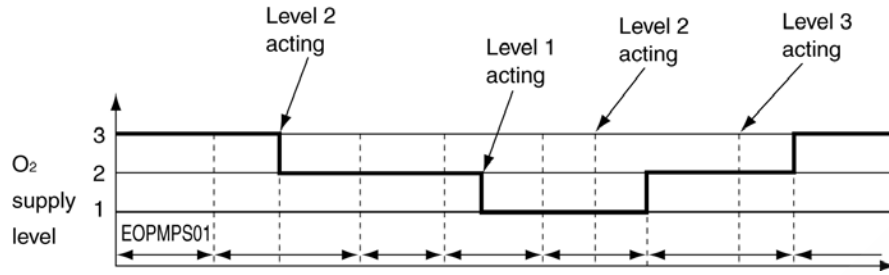

Oxygen enrich freeze-up prevention control (status 1a, 1b)

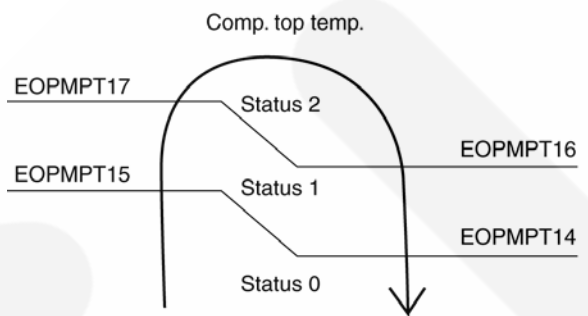

Outdoor air temp. status	O ₂ supply level
5	0
4	1
3	2
2	3
1	Continuous running (∞) (freeze-up prevention control)
0	0

Comp. top temp. status	O ₂ supply level
2	1
1	2
0	3

O ₂ Enrich Operation	Protection Control O ₂ supply level	Vacuum Pump Operation Time		Remark
		OFF time (min)	ON time (min)	
ON	0	EOPMPS01 - EOPMPS04	EOPMPS04	Continuous OFF
	1	EOPMPS01 - EOPMPS02	EOPMPS03	3 min ON 7 min OFF
	2	EOPMPS01 - EOPMPS03	EOPMPS02	7 min ON 3 min OFF
	3	0	EOPMPS01	Continuous ON

※ In this condition, when Oxygen operation is ON, vacuum pump run continuously regardless of O₂ supply level (vacuum pump continuous running control (C-2) is deactivated).

For detail, refer to freeze-up prevention, vacuum pump continuous running control (F-2).

Detail Explanation for Specification

Data Name	Item	Data
EOPMPS01	Vacuum pump operation cycle time	10 min
EOPMPS02	O ₂ supply level 2, vacuum pump ON time	7 min
EOPMPS03	O ₂ supply level 1, vacuum pump ON time	3 min
EOPMPS04	O ₂ supply level 0, vacuum pump ON time	0 min

- Base on outdoor air temp. & comp. top temp., vacuum pump ambient temp. is projected to prevent vacuum pump temp. rise.
- To prevent ice formation in connecting tube during low outdoor air temperature, continuous running protection control is implemented.
(During low outdoor temp., stagnant water in tube may freeze-up if ON/OFF operation is implemented).
- If outdoor temp. sensor abnormal, open or short circuit, temperature reading become below -10°C or above 40°C where the O₂ supply level will become 0 (operation stop).
- Outdoor air temp. update/renew every 30 min during soft dry mode (instant renewal for other mode).

Data Name	Description	Data
EOPMPT01	Outdoor air temp. control temp.	-12°C
EOPMPT02	Outdoor air temp. control temp.	-10°C
EOPMPT03	Outdoor air temp. control temp.	-10°C
EOPMPT04	Outdoor air temp. control temp.	-8°C
EOPMPT05	Outdoor air temp. control temp.	3°C
EOPMPT06	Outdoor air temp. control temp.	5°C
EOPMPT07	Outdoor air temp. control temp.	26°C
EOPMPT08	Outdoor air temp. control temp.	27°C
EOPMPT09	Outdoor air temp. control temp.	32°C
EOPMPT10	Outdoor air temp. control temp.	33°C
EOPMPT11	Outdoor air temp. control temp.	44°C
EOPMPT12	Outdoor air temp. control temp.	45°C
EOPMPT13	Outdoor air temp. correction value, Heat	0 deg
EOPMPT14	Comp. top temp. control	44°C
EOPMPT15	Comp. top temp. control	45°C
EOPMPT16	Comp. top temp. control	69°C
EOPMPT17	Comp. top temp. control	70°C

2. Vacuum pump continuous running control

- Vacuum pump continuous running control

(Life span counter measure)

Direction : O₂ supply level, continuous running instruction time

Control : O₂ supply level

- Action explanation : O₂ supply level when continue for EOPMPS05 min, the proceeding level 3 will limited to maximum level MOPMPL01.
- Exceptional condition :
 - Outdoor air temp. status 1 (ice prevention control activated).
 - O₂ supply level detection is lower than 3.

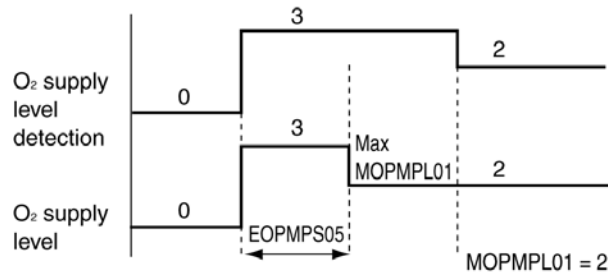

Detail Explanation for Specification

- Life span counter measure

Increase life span by limiting vacuum pump continuous running period (assure life span of over 30,000h).

- Temp. rise counter measure.

- OLP

Vacuum pump OLP

- Open temp. : $120 \pm 5^{\circ}\text{C}$
- Close temp. : $76 \pm 15^{\circ}\text{C}$

Data Name	Item	Data
EOPMPS05	Vacuum pump continuous running control judgement time	FF
MOPMPL01	Vacuum pump continuous running maximum supply level	2
MOPMPS06	Vacuum pump restart prevention time	30s
MOPMPS07	Vacuum pump delay start time	30s

Note: This control is deactivated when EOPMPS05 is set to FF.

3. Vacuum pump restart prevention control

- To avoid starting noise cause by frequent restart of vacuum pump in short period of time.

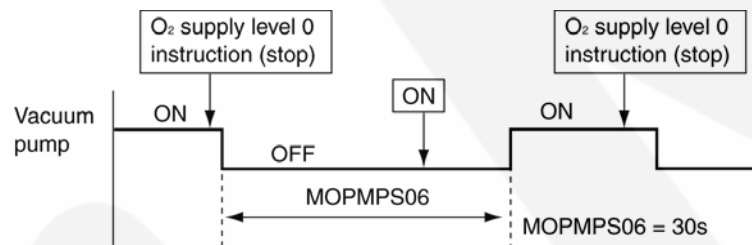

- If combined with other operation mode where outdoor fan running, restart control time is MOPMPS06.
- If Oxygen only operation, restart control time is MOPMPS06 + MOPMPS07.
- Restart prevention control does not operate when Oxygen is pressed ON during Oxygen delay OFF control.

4. 2 way valve control

2 way valve is ON periodically to avoid it from locking after long period of idling.

- Activation condition

When OD power relay ON signal is generated.

- Activation content

2 way valve is ON for about 5s (valve open).

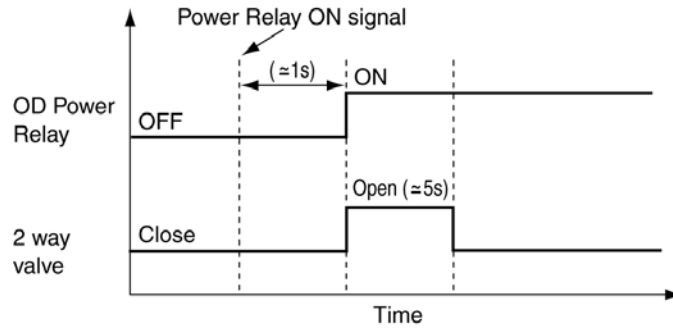

D. Oxygen Enrich Starting Control

1. Purpose

- Improve Oxygen supply amount by supplying fresh air to surrounding area of Oxygen enrich membrane during starting time.
- Masking of vacuum pump starting sound.
- Prevent vacuum pump starting difficulty at low outdoor temperature.
- Flash out water trapped in connecting tube at low outdoor temperature.

2. Normal operation

Outdoor fan is ON as operation start. Vacuum pump ON after operation start after MOPMPS07 second. At the same time when fan is ON, 2 way valve is ON for EOBENS01 (EOBENS02) second (2 way valve won't operate if outdoor air temp higher than EOBENT01).

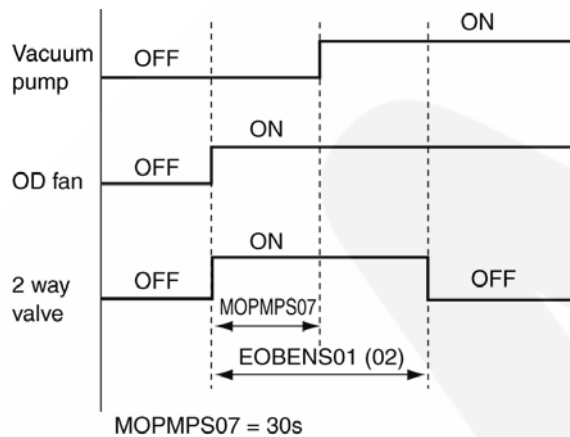

<Exceptional condition>

- Outdoor fan is ON when Oxygen operation start.
- Outdoor fan is OFF during deice operation when Oxygen operation start.

At condition a ~ b, vacuum pump & 2 way valve ON immediately as Oxygen operation start.

OD air temp., T	2 way valve ON duration (min)
$EOBENT01 < T$	0
$EOBENT02 < T \leq EOBENT01$	EOBENS01
$T \leq EOBENT02$	EOBENS02

Detail Explanation for Specification

Possibilities of poor start-up of vacuum pump due to deterioration of bearing grease at low outdoor temperature.
 ↓
 2 way valve open to reduce load

- At low outdoor air temp., O₂ supply level fixed at level 3.
- Priority to stopping control.

Date name	Description	Data
MOPMPS07	Vacuum pump operation start delay time	30s
EOBENS01	Oxygen enrich start control 2 way valve operation time (Ave)	30 min
EOBENS02	Oxygen enrich start control 2 way valve operation time (Low)	30 min
EOBENT01	Oxygen enrich start control, outdoor air temperature	-5°C
EOBENT02	Oxygen enrich start control, outdoor air temperature	-10°C

3. Low voltage operation

As counter action at low voltage where starting torque reduce, low voltage detection is done where the 2 way valve opening time is increased.

a. Voltage memory

DC voltage detection is done once power relay is ON and before compressor start. If the detected voltage is lower than EOBENV01, voltage condition is set to <Low voltage>. If detected voltage is EOBENV01 or higher, voltage condition is set to <Normal>. (Judgement is done every time power relay is ON).

b. Action

Voltage condition judge as <Low voltage>.

- Oxygen enrich start control outdoor air temperature EOBENT01(02) is shifted by adding EOBENT03 and 2 way valve start control activation range is enlarge.
- Oxygen enrich start control 2 way valve open duration EOBENS01(02) is increased by adding EOBENS03.

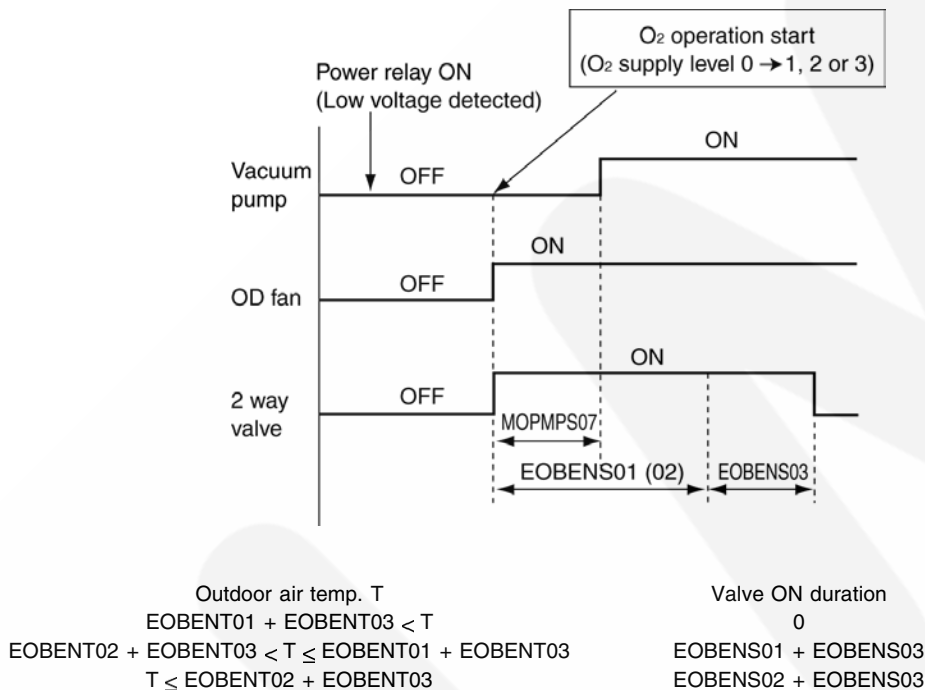

Date name	Description	Data
EOBENV01	Low voltage judgement DC voltage	180V
EOBENT03	Low voltage start control, outdoor air temp. shift valve	+10°C
EOBENS03	Low voltage start control, 2 way valve activation prolong time	40 min

E. Oxygen Enrich Stop Control

- Masking stopping sound of vacuum pump.
- Blow out residual water in the tube.

Action outline

- Vacuum pump : O₂ supply level → 0, vacuum stop after EOTteisi second.
- OD fan : After vacuum pump stop, OD fan stop after OTfan1 second.
- 2 way valve : As O₂ supply level → 0, 2 way valve ON for EOTteisi second and then OFF.
(Note: EOTteisi varies as outdoor air temp. change)

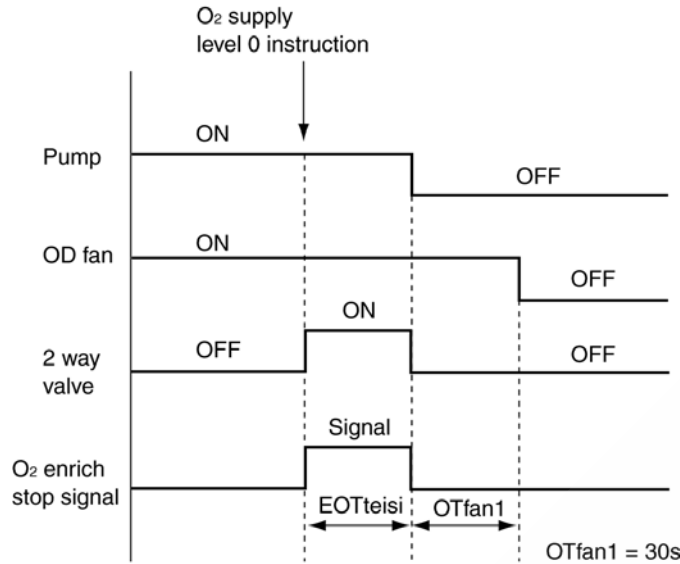

* While O₂ operation & outdoor air goes below EOPMPT01, O₂ supply level become 0, stop control will take place.

Exceptional condition

- During vacuum pump delay ON within MOPMPS07 second in the start control

Outdoor air temp. T	EOTteisi
EOBENT04 < T	EOBENS04
EOBENT05 < T ≤ EOBENT04	EOBENS05
EOBENT06 < T ≤ EOBENT05	EOBENS06
T ≤ EOBENT06	EOBENS07

Detail Explanation for Specification

- In order to blow out water from tube, 2 way valve is open before vacuum pump stop during stop operation. At this condition, air flow increase 4 ~ 5 times, where indoor O₂ supply sound will increase but not noticeable at normal operation.
- Freeze-up countermeasure (2 way valve)

In order to blow out residual moisture in tube during stop operation (flow velocity up, low humid air intake). Stop delaying time change as the amount of dew formed depend on outdoor air temperature.

Date name	Description / Designation	Data
OTfan1	Outdoor fan delay stop time	30s
EOBENS04	Hi OD temp., stop control, pump & valve ON time	0s
EOBENS05	Me OD temp., stop control, pump & valve ON time	150s
EOBENS06	Lo OD temp., stop control, pump & valve ON time	150s
EOBENS07	SLo OD temp., stop control, pump & valve ON time	270s
EOBENT04	Stop control, Outdoor air temp.	10°C
EOBENT05	Stop control, Outdoor air temp.	2°C
EOBENT06	Stop control, Outdoor temp.	-3°C

- Power relay delay stop time is 5 min during stop operation. Therefore maximum delay stop time is 270s.

F. Oxygen Enrich Freeze-Up Prevention Control

1. Control outline

- To avoid water in tube from freeze-up during low outdoor temperature.
- Only vacuum pump restart control of protection control is operating.

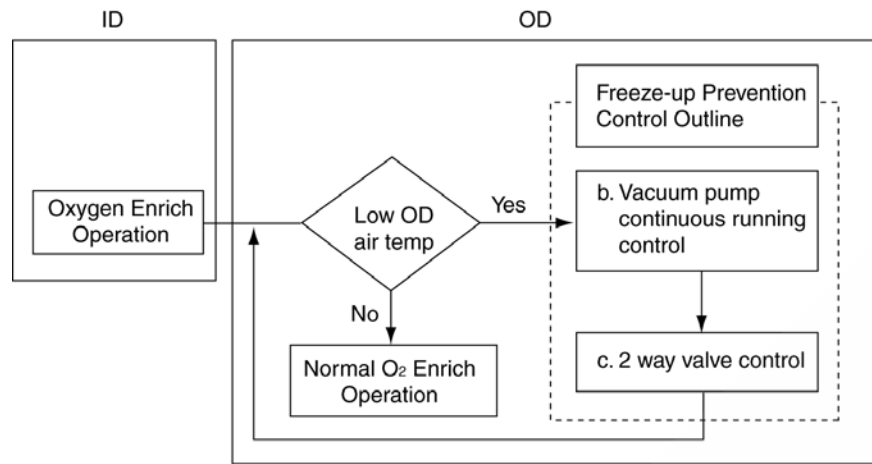

2. Freeze-up prevention, vacuum pump continuous running control

- Avoid freeze-up in tube by vacuum pump continuous running at low outdoor temp.
- Start condition
 - a. OD temp status 1(a,b)
 - b. O₂ supply level $\neq 0$
- Control content
 - a. Continuous running disregard of oxygen supply level
- Cancellation condition
 - Start condition not fulfilled
- Exceptional condition

During deice & MOPMPS08 after deice, OD temp. status does not update as the OD fan is stop. (Air temp. detection disable).

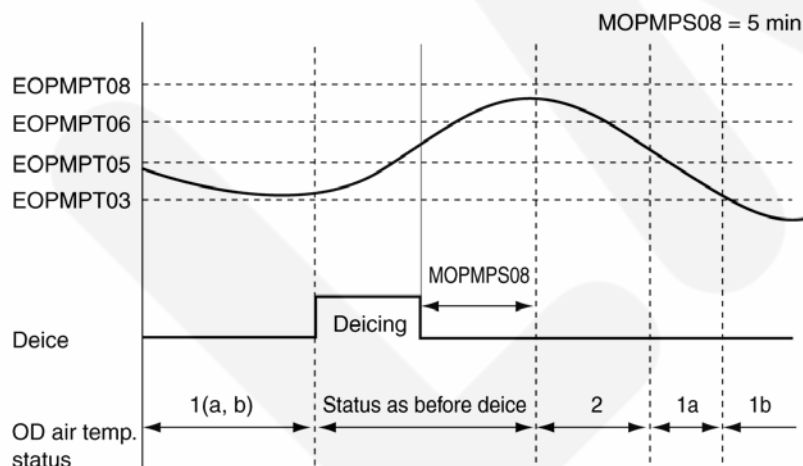

3. Freeze-up prevention, 2 way valve control

- Open valve periodically to prevent freeze-up during low OD air temp.
- Open valve duration change according to air temp. status (1a or 1b).
- a. Start condition

Either one of below condition is fulfilled.

 - i. O₂ supply level $\neq 0$ & OD air temp status shift to 1(a,b).

ii. OD air temp. status 1(a, b) & O₂ supply level 0 → ≠ 0.

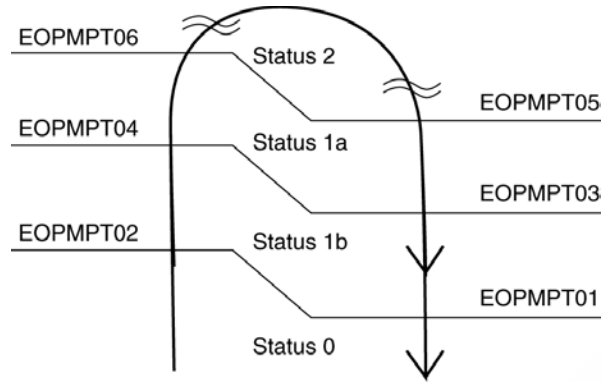

b. Control content

2 way valve is ON periodically as shown below.

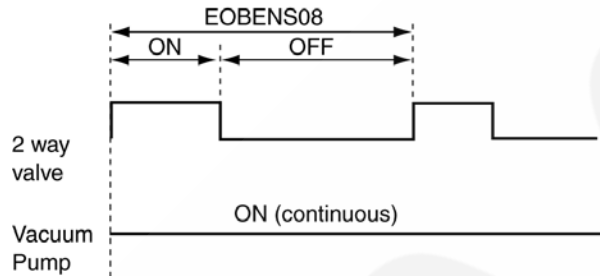

Freeze-up prevention, 2 way valve control	OD air temp.	2 way valve OFF time	2 way valve ON time
	Status 1a	EOBENS08 - EOBENS09	EOBENS09
	Status 1b	EOBENS08 - EOBENS10	EOBENS10

c. Control cancellation condition

- i. O₂ supply level shift to 0
- ii. OD air temp status shift from 1 → ≠ 1

Either i. or ii. is true, timer reset & 2 way valve ON/OFF operation end.

Note: 2 way valve control for freeze-up prevention at start condition ii. include Oxygen enrich start control.

Detail Explanation for Specification

Date name	Designation	Data
EOBENS08	Freeze prevention, 2 way valve control cycle time	20 min
EOBENS09	OD air status 1a, 2 way valve ON time	15 min
EOBENS10	OD air status 1b, 2 way valve ON time	15 min
EOPMPT01	OD air temp. control	-12°C
EOPMPT02	OD air temp. control	-10°C
EOPMPT03	OD air temp. control	-10°C
EOPMPT04	OD air temp. control	-8°C
EOPMPT05	OD air temp. control	3°C
EOPMPT06	OD air temp. control	5°C

G. Installation (O₂) Check Control

From the installation check signal release by indoor unit, vacuum pump & 2 way valve is ON continuously for installation fault detection.

(Pump & valve delay start & delay OFF control is inactive).

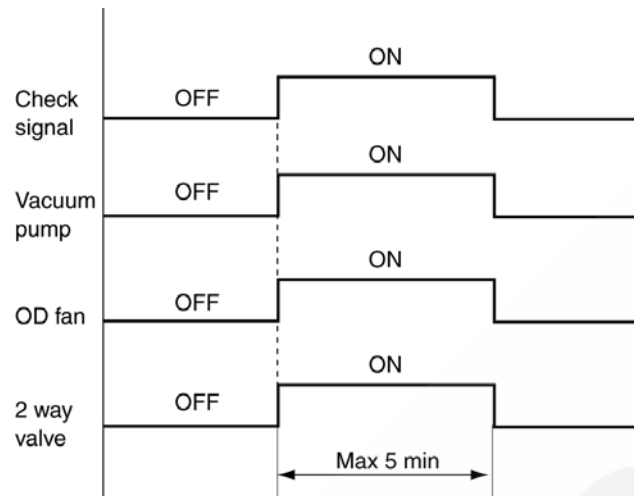

H. OD Fan Control (ON or OFF)

1. Oxygen only operation

OD fan is ON or OFF according to Oxygen enrich control.

2. Combined operation with other mode

When combined operation with other mode, OD fan control is as follows;

OD Fan = ON : If OD fan status is ON in any of the combined operation mode (except during deice operation of Heating mode)

OD Fan = OFF : i) Deice operation in progress
ii) If OD fans status is OFF in all of the combined operation mode

9 Operating Instructions

■ Definition

To prevent personal injury, injury to others and property damage, the following instructions must be followed.

Incorrect operation due to failure to follow instructions will cause harm or damage, the seriousness of which is classified as below:



Warning

This sign warns of death or serious injury.



Caution

This sign warns of injury or damage to property.

The instructions to be followed are classified by the following symbols:



This symbol denotes an action that is PROHIBITED.



These symbols denote actions that are COMPULSORY.

Thank you for purchasing Panasonic Air Conditioner

SAFETY PRECAUTIONS

Installation Precautions



Warning

Do not install, remove and reinstall the unit by yourself.

- Improper installation will cause leakage, electric shock or fire. Please consult an authorized dealer or specialist for the installation work.



Caution



- This air conditioner must be earthed. Improper grounding will cause electric shock.
- Ensure that the drainage piping is connected properly. Otherwise, water will leak.
- Current leakage protection equipment must be installed. Otherwise, electric shock or fire may occur.



- Do not install the unit in a potentially explosive atmosphere.

Operation Precautions



Warning



- Do not share power outlet.
- Do not modify power cord.
- Do not use an extension cord.
- Do not operate with wet hands.
- Do not operate or stop the unit by inserting or pulling out the power plug.
- Do not insert finger or other objects into the indoor or outdoor unit.
- Do not attempt to repair the unit by yourself.
- Do not use rechargeable (Ni-Cd) batteries.
- Keep the remote control away from infants and small children to prevent them from accidentally swallowing the batteries.



- Insert the power plug properly.
- Use specified supply cord.
- If the supply cord is damaged or needed to be replaced, it must be replaced by the manufacturer or its service agent or a similarly qualified person in order to avoid a hazard.
- Remove the batteries if the unit is not going to be used for a long period of time.
- New batteries of the same type must be inserted following the polarity stated to prevent malfunction of the remote control.



- In case of emergency or abnormal condition (burnt, smell, etc) occurs, turn off the power supply and unplug.



Caution



- Do not pull the cord to disconnect the plug.
- Do not wash the unit with water, benzene, thinner or scouring powder.
- Do not use for other purposes such as preservation of food.
- Do not use any combustible equipment at airflow direction.
- Do not sit or place anything on the indoor or outdoor unit.
- Do not expose directly to cold air for a long period.



- Ventilate the room regularly.
- Pay attention as to whether the installation rack is damaged after long period of usage.



- Switch off the power supply and unplug before cleaning or servicing.
- Turn off the power supply and unplug if the unit is not used for a long period of time.

Safety Regulation

The appliance is not intended for use by young children or infirm person without supervision. Young children should be supervised to ensure that they do not play with the appliance.

Replacement or installation of power plugs shall be performed by authorized/qualified personnel only. The wires in this mains lead are coloured in accordance with the following code:

Terminals	wires	colours (GB Standard)
L	live	brown
N	neutral	blue
E	earth	green-yellow

Different countries may have different colour coding for the wires.

Operation Condition (°C)

Use this air conditioner under the following temperature range.

DBT: Dry Bulb Temperature WBT: Wet Bulb Temperature	Indoor		Outdoor	
	DBT	WBT	DBT	WBT
Maximum Temperature (COOL)	32	23	43	26
Maximum Temperature (HEAT)	30	-	24	18
Minimum Temperature (COOL)	16	11	16	11
Minimum Temperature (HEAT)	16	-	-5	-6

Note: The illustrations in this manual are for explanation purposes only and may differ from the actual unit. It is subjected to change without notice for future improvement.

PRODUCT OVERVIEW

Indoor Unit

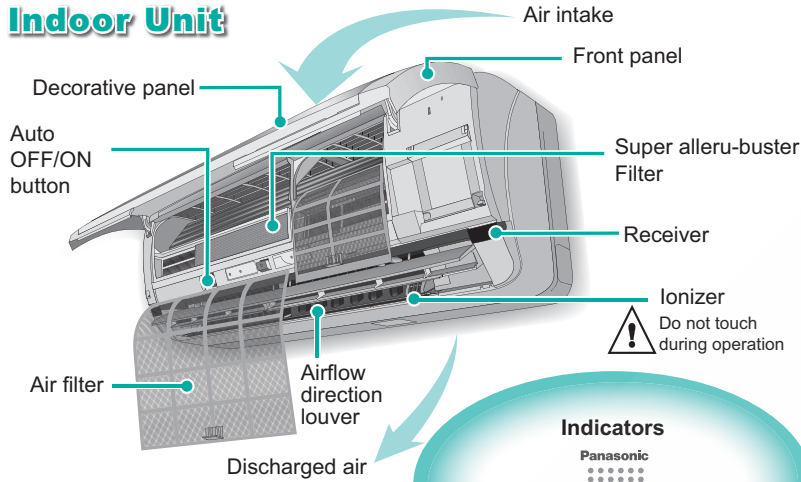

Outdoor Unit

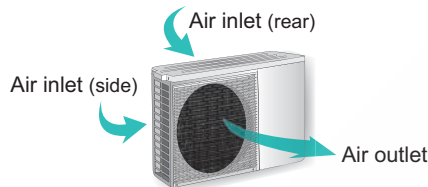

Remote Control

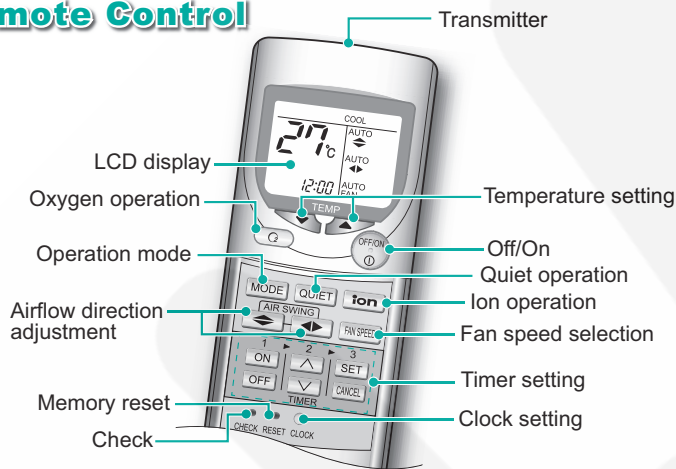

About

Remote Control Preparation

1. Pull out
 2. Insert batteries (AAA or R03)
 3. Press CLOCK button
 4. Set current time
 5. Press again to confirm
- Timer operation will be based on current time set.
 - The batteries can be used for approximately 1 year.
 - The batteries must be recycled or disposed of properly.

Remote Control Signal

- Make sure it is not obstructed.
- Maximum distances: 10m.
- Certain fluorescent lights may interfere with signal transmission. Consult your dealer.

Auto OFF/ON Button

- To operate the unit if the remote control is misplaced or malfunctioning.

Action	Operation mode
Press once	Automatic Operation
Press until "beep" sound and release.	Cooling Operation
Press until "beep-beep" sound and release.	Heating Operation
Press until 3"beep" sound and release. Press again until "beep" sound and release.	Oxygen Operation

- To OFF, press again the Auto OFF/ON button.

Troubleshooting

- | | |
|--|---|
| ● Operation delayed for few minutes after restart. | ➤ This is a normal self protection control. |
| ● Sound like water flowing during operation. | ➤ Caused by refrigerant flow inside. |
| ● Mist emerges from indoor unit. | ➤ Condensation effect due to cooling process. |
| ● Noisy during operations. | ➤ Installation work could be slanted or front panel didn't close properly. |
| ● Remote control/display does not work. | ➤ Check whether batteries are correctly inserted or needs replacement. |
| ● The unit cannot operate. | ➤ Check either circuit breaker is tripped, power plug is inserted correctly or timer is used correctly. |
| ● Outdoor unit emits water/steam. | ➤ Condensation or evaporation happens at piping surface. |

■ Operation Details

AUTO - Automatic Operation

- The unit will automatically select the operation mode according to the setting, outdoor and room temperature. During operation mode selection, power indicator blinks. For every 30 minutes, the operation mode is reselected.
- The range of temperature can be selected from 16°C~30°C.

HEAT - Heating Operation

- Enables you to enjoy the warming effect at your preferred setting temperature.
- For cold air prevention, air might not blow out immediately and power indicator blinks when operation starts.
- Also operates in defrost mode (maximum 10 minutes) where by the power indicator blinks. The melted frost is drained at outdoor unit and indoor fan is stopped.
- The range of temperature can be selected from 16°C~30°C.

COOL - Cooling Operation

- Enables you to enjoy the cooling effect at your preferred setting temperature.
- The range of temperature can be selected from 16°C~30°C.

DRY - Soft Dry Operation

- Enables you to set the desired temperature at low fan speed which provides you with the dehumidifying surroundings.
- The range of temperature can be selected from 16°C~30°C.

FAN - Air Circulation Operation

- Fan operation to circulate air in the room.

HOW TO OPERATE

Auto, Heat, Cool, Dry, Fan

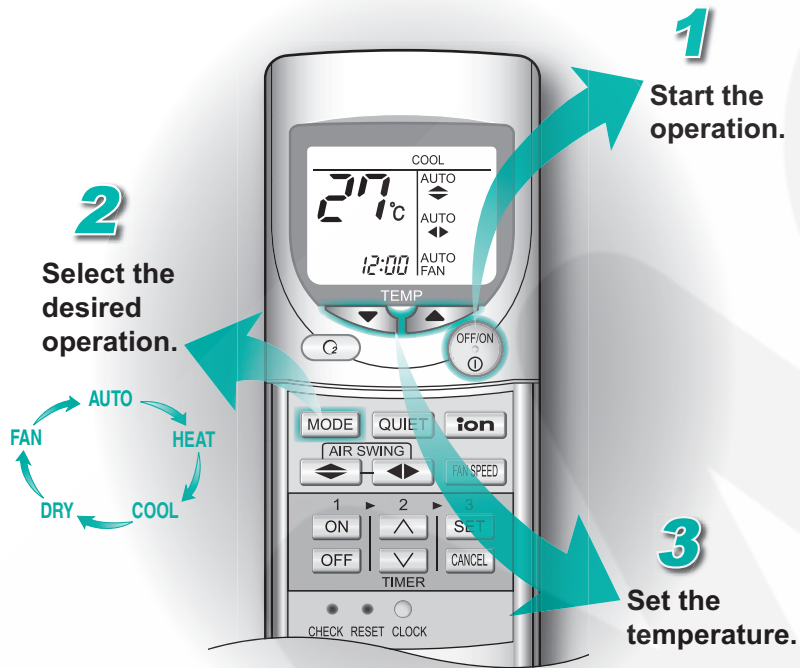

- Oxygen, Quiet and Ion operations could be activated in all operation modes.

- Press button again to stop the operation.



Hint

- To save electricity, close the curtains when using air conditioner to prevent sunlight and heat from coming in.
- Approximately 10% of electricity can be saved if you set the temperature 1°C higher in cooling operation or 2°C lower in heating operation than the desired temperature.
- If you wish to have the cool air blowing directly on you, set the airflow direction downward but not for an excessive length of time, as it may harm your health.



Troubleshooting

- The room has a peculiar odour.
 - This may be a damp smell emitted by the wall, carpet, furniture or clothing in the room.
- Air conditioner does not cool or heat efficiently.
 - Ensure the temperature has been set correctly.
 - Ensure windows and doors have been closed properly.
 - Ensure filters are cleaned or replaced when necessary.
 - Ensure inlet and outlet vents of the units have not been obstructed.

HOW TO OPERATE

Oxygen, Quiet, Ion, Fan Speed, Air Swing

OXYGEN

Enables oxygen operation.

QUIET

Enables quiet operation.

ION

Enables ion operation.

FAN SPEED

Select fan speed.

AIR SWING

Adjust the vertical or horizontal airflow direction louver.

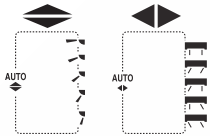

Operations Details

OXYGEN

- Enriches oxygen content in fresh air.
- Oxygen operation could be activated independently.

QUIET

- To provide a quiet environment.



ION

- To provide fresh air effect by producing negative ions.
- Ion operation could be activated independently.
- Press  button to stop the operation.

FAN SPEED

- To provide you with the various fan speed selections.
- There are 5 levels of fan speed in addition to automatic fan speed.
- Automatic fan speed:
The speed of the indoor fan is automatically adjusted according to the operation.

AIR SWING

-  To ventilate air in the room.
- There are 5 selections in addition to automatic vertical air flow direction.
- If automatic vertical airflow direction has been set, the louver swings up and down automatically.
-  To ventilate air in the room.
- There are 5 selections in addition to automatic horizontal air flow direction.
- If automatic horizontal airflow direction has been set, the louver swings left and right automatically.

- Please do not adjust the vertical and horizontal airflow direction louver manually.

- Oxygen, Quiet and Ion operations could be cancelled by pressing the respective button again.



Troubleshooting

- | | |
|---|---|
| ● ION indicator on the indoor unit is blinking. | ➤ Press ION button twice. If the indicator is still blinking, please consult the dealer. |
| ● Indoor fan stops occasionally during Automatic Fan Speed setting. | ➤ This is an advanced feature that helps to remove smell from the surrounding area during operation. |
| ● Indoor fan stops occasionally during heating operation. | ➤ To avoid unintended cooling effect. |
| ● Soft splashing sound from indoor unit during oxygen operation. | ➤ Sound emitted by high humidity airflow from oxygen tube. |
| ● Smell during oxygen operation. | ➤ Oxygen brought in from the outside air may contain odour. Remove source of odour around the outdoor unit. |
| ● Slight increase in sound level from outdoor unit. | ➤ Sound increased caused by oxygen operation. |

■ Operation Details

TIMER

- Use the ON timer to turn on the air conditioner at the desired time. This will give you a cooling or warming environment, e.g. when you return from work or wake up.
- When the ON timer is set, operation will start up to 35 minutes before the actual set time.
- Use the OFF timer to stop the air conditioner operation at the desired time. This can save electricity while you are going out or sleeping.
- The set timer will repeat daily once it is set.
- If there is a power failure, you can press SET button to restore the previous setting once the power is resumed.
- If the timer is cancelled, you can restore the previous setting by pressing SET button.

CHECK

- When there is error, the unit stops its operation and timer indicator blinks.

1. Press for 5 seconds.

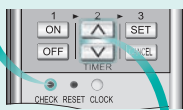

2. Browse for respective error code, where "beep" sounds are heard.
3. Turn off the power supply and call authorized distributor.

Note:
Press the 'Reset' button to quit checking.

Unit might operate with limited function depending on error found. (Operation starts, 4 "beep" sounds are heard)

HOW TO OPERATE

Timer

1

Select ON or OFF timer.

2

Set the desired time.

3

Confirm the setting.

CANCEL

Cancel the selected timer.

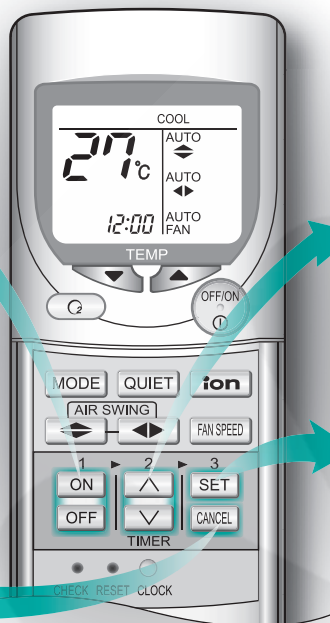

- Ensure the clock on the remote control has been set correctly.
- You could use the ON and OFF timers at the same time.
- To cancel either the ON or OFF timer, press **ON** or **OFF**, then press **CANCEL**.



Hint

- For your convenience, you could set the air conditioner to operate automatically by using both ON and OFF timer.



Troubleshooting

- **TIMER** indicator always on.
 - Timer is activated and the setting will repeat itself daily.
- **POWER** indicator is blinking 35 minutes before ON timer is activated.
 - The unit is determining the operation mode by sensing the room temperature. This happens when it has been set to AUTO operation mode.

CARE & CLEANING



Switch off the power supply before cleaning

DECORATIVE PANEL

Remove, wash and dry.

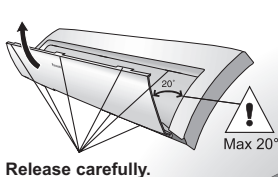

FRONT PANEL

Raise and pull to remove. Wash and dry.

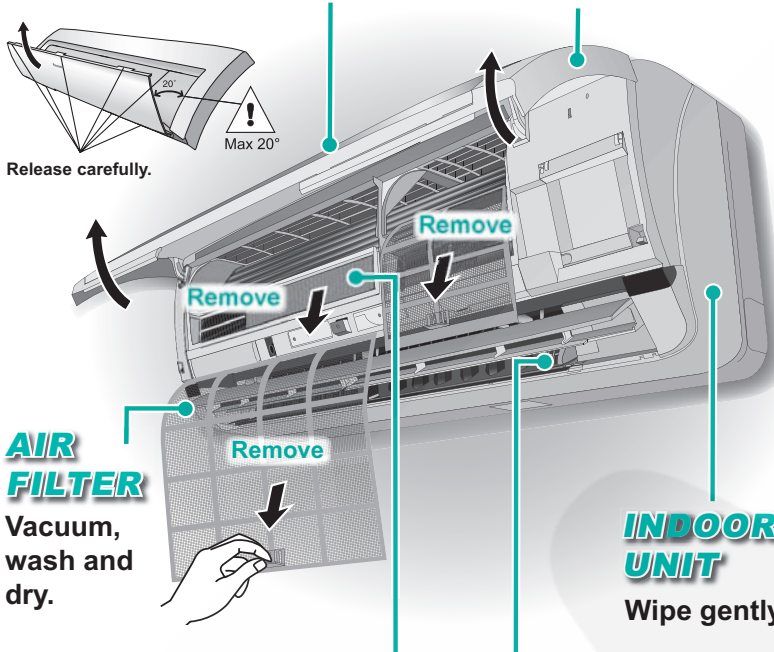

AIR FILTER

Vacuum, wash and dry.

SUPER ALLERU-BUSTER FILTER

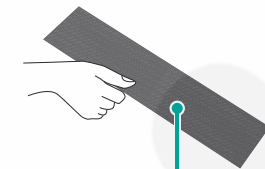

Vacuum the super allergu-buster filter.

IONIZER

Clean with cotton bud.

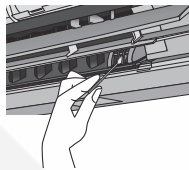

INDOOR UNIT

Wipe gently.

Washing Instructions

- Do not use benzene, thinner or scouring powder.
- Use soaps or neutral household detergent (≈ pH7) only.
- Do not use water with temperature higher than 40°C.

INDOOR UNIT

- Wipe the unit gently with a soft, dry cloth.

AIR FILTER

- It is recommended to clean the air filters once every 2 weeks.
- Purchase the replacement filter if it is damaged.

Part no.: CWD001053 (Left)

CWD001054 (Right)

SUPER ALLERU-BUSTER

- It is recommended to clean the filter every 6 months.
- Replace the filter every 3 years or purchase the replacement filter if it is damaged.

Part no.: CZ-SA14P

IONIZER

- It is recommended to clean the ionizer every 6 months.

Preparation for extended Non-operation

- Operate the unit for 2~3 hours using heating operation to dry the internal parts.
- Turn off the power supply and unplug.
- Remove the remote control batteries.

Pre-season Inspection

- This inspection is recommended before operating the air conditioner at every season.
- Check if the remote control batteries needed to be replaced.
- Ensure there is no obstruction at all air intake and outlet vents.
- After the start of operation for 15 minutes, it is normal if the temperature differences between air intake and outlet vents at indoor unit is:-

Operation	Temperature
Cooling	≥ 8°C
Heating	≥ 14°C

Hints



- Clean the filter regularly as dirty filters will cause unpurified air, low cooling or heating capacity, unpleasant smells and higher energy consumption.
- The unit will become dirty and the performance of the unit will decrease after used for several seasons. Please consult an authorized dealer to perform seasonal inspections in addition to regular cleaning.
- This air conditioner is equipped with a built-in surge protective device. However, in order to further protect your air conditioner from being damaged by abnormally strong lightning activity, you may switch off the power supply.

10 Installation Instructions

Required tools for Installation Works			
1. Philips screw driver	5. Spanner	9. Gas leak detector	13. Multimeter
2. Level gauge	6. Pipe cutter	10. Measuring tape	14. Torque wrench 18 N.m (1.8 kgf.m) 42 N.m (4.2 kgf.m) 55 N.m (5.5 kgf.m)
3. Electric drill, hole core drill ($\phi 70$ mm)	7. Reamer	11. Thermometer	15. Vacuum pump
4. Hexagonal wrench (4 mm)	8. Knife	12. Megameter	16. Gauge manifold

10.1. Safety Precautions

- Read the following “SAFETY PRECAUTIONS” carefully before installation.
- Electrical work must be installed by a licensed electrician. Be sure to use the correct rating of the power plug and main circuit for the model to be installed.
- The caution items stated here must be followed because these important contents are related to safety. The meaning of each indication used is as below. Incorrect installation due to ignoring of the instruction will cause harm or damage, and the seriousness is classified by the following indications.



 WARNING	This indication shows the possibility of causing death or serious injury.
---	---

 CAUTION	This indication shows the possibility of causing injury or damage to properties only.
---	---

The items to be followed are classified by the symbols:

	Symbol with background white denotes item that is PROHIBITED from doing.
---	--

- Carry out test running to confirm that no abnormality occurs after the installation. Then, explain to user the operation, care and maintenance as stated in instructions. Please remind the customer to keep the operating instructions for future reference.

 WARNING	
1. Engage dealer or specialist for installation. If installation done by the user is defective, it will cause water leakage, electrical shock or fire.	
2. Install according to this installation instruction strictly. If installation is defective, it will cause water leakage, electrical shock or fire.	
3. Use the attached accessories parts and specified parts for installation. Otherwise, it will cause the set to fall, water leakage, fire or electrical shock.	
4. Install at a strong and firm location which is able to withstand the set's weight. If the strength is not enough or installation is not properly done, the set will drop and cause injury.	
5. For electrical work, follow the local national wiring standard, regulation and this installation instruction. An independent circuit and single outlet must be used. If electrical circuit capacity is not enough or defect found in electrical work, it will cause electrical shock or fire.	
6. Use the specified cable (1.5 mm ²) and connect tightly for indoor/outdoor connection. Connect tightly and clamp the cable so that no external force will be acted on the terminal. If connection or fixing is not perfect, it will cause heat-up or fire at the connection.	
7. Wire routing must be properly arranged so that control board cover is fixed properly. If control board cover is not fixed perfectly, it will cause heat-up at connection point of terminal, fire or electrical shock.	
8. When carrying out piping connection, take care not to let air substances other than the specified refrigerant go into refrigeration cycle. Otherwise, it will cause lower capacity, abnormal high pressure in the refrigeration cycle, explosion and injury.	
9. Do not damage or use unspecified power supply cord. Otherwise, it will cause fire or electrical shock.	
10. Do not modify the length of the power supply cord or use of the extension cord, and do not share the single outlet with other electrical appliances. Otherwise, it will cause fire or electrical shock.	











CAUTION

1. The equipment must be earthed. It may cause electrical shock if grounding is not perfect.
2. Do not install the unit at place where leakage of flammable gas may occur. In case gas leaks and accumulates at surrounding of the unit, it may cause fire. 
3. Carry out drainage piping as mentioned in installation instructions. If drainage is not perfect, water may enter the room and damage the furniture.

ATTENTION

1. Selection of the installation location.
Select an installation location which is rigid and strong enough to support or hold the unit, and select a location for easy maintenance.
2. Power supply connection to the room air conditioner.
Connect the power supply cord of the room air conditioner to the mains using one of the following method.
Power supply point shall be the place where there is ease for access for the power disconnection in case of emergency.
In some countries, permanent connection of this room air conditioner to the power supply is prohibited.
 1. Power supply connection to the receptacle using a power plug.
Use an approved 15A/16A power plug with earth pin for the connection to the socket.
 2. Power supply connection to a circuit breaker for the permanent connection. Use an approved 16A circuit breaker for the permanent connection. It must be a double pole switch with a minimum 3 mm contact gap.
3. Do not release refrigerant.
Do not release refrigerant during piping work for installation, reinstallation and during repairing a refrigeration parts. Take care of the liquid refrigerant, it may cause frostbite.
4. Installation work.
It may need two people to carry out the installation work.
5. Do not install this appliance in a laundry room or other location where water may drip from the ceiling, etc.

Attached accessories

No.	Accessories part	Qty.	No.	Accessories part	Qty.
1	Installation plate 	1	6	Remote control holder 	1
2	Installation plate fixing screw 	6	7	Remote control holder fixing screw 	2
3	Remote Control 	1	8	Oxygen Tube 	1
4	Battery 	2	9	Drain elbow 	1
5	Super Alleru-buster filter 	1			

Applicable piping kit
 CZ-3F5, 7BP (XE9DK)
 CZ-4F5, 7, 10BP (XE12DK)

SELECT THE BEST LOCATION

INDOOR UNIT

- There should not be any heat source or steam near the unit.
- There should not be any obstacles blocking the air circulation.
- A place where air circulation in the room is good.
- A place where drainage can be easily done.
- A place where noise prevention is taken into consideration.
- Do not install the unit near the door way.
- Ensure the spaces indicated by arrows from the wall, ceiling, fence or other obstacles.
- Recommended installation height for indoor unit shall be at least 2.3 m.

OUTDOOR UNIT

- If an awning is built over the unit to prevent direct sunlight or rain, be careful that heat radiation from the condenser is not obstructed.
- There should not be any animal or plant which could be affected by hot air discharged.
- Keep the spaces indicated by arrows from wall, ceiling, fence or other obstacles.
- Do not place any obstacles which may cause a short circuit of the discharged air.
- If piping length is over the common length, additional refrigerant should be added as shown in the table.

Model	Piping size		Common Length (m)	Max. Elevation (m)	Max. Piping Length (m)	Additional Refrigerant (g/m)
	Gas	Liquid				
XE9DK	3/8"	1/4"	7.5	5	15	20
XE12DK	1/2"	1/4"	7.5	5	15	20

Indoor/Outdoor Unit Installation Diagram

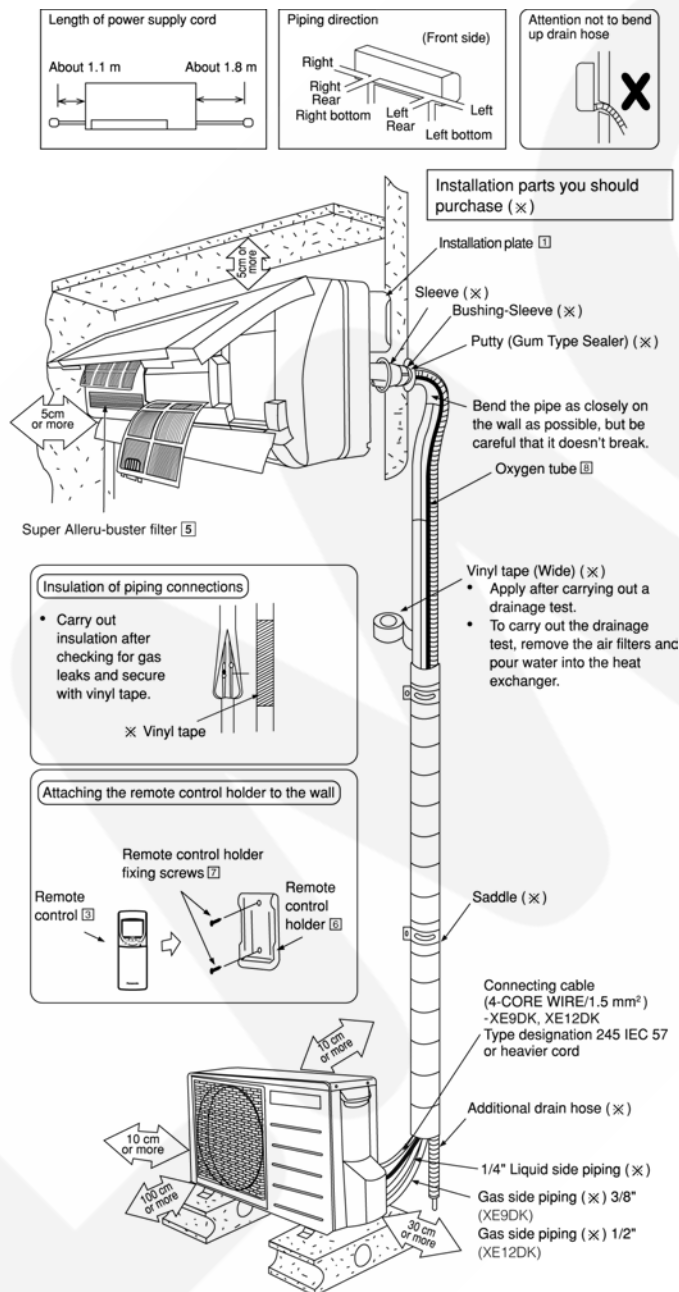

• This illustration is for explanation purposes only. The indoor unit will actually face a different way.

10.2. Indoor Unit

10.2.1. SELECT THE BEST LOCATION (Refer to “Select the best location” section)

10.2.2. HOW TO FIX INSTALLATION PLATE

The mounting wall is strong and solid enough to prevent it from the vibration.

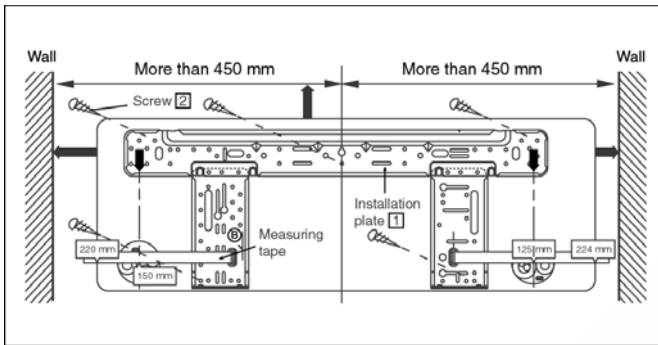

The centre of installation plate should be at more than 450 mm at right and left of the wall.

The distance from installation plate edge to ceiling should more than 67 mm.

From installation plate left edge to unit's left side is 47 mm.

From installation plate right edge to unit's right is 73 mm.

- Ⓑ :
- : For left side piping, piping connection for liquid should be about 14 mm from this line.
 - : For left side piping, piping connection for gas should be about 56 mm from this line.
 - : For left side piping, piping connecting cable should be about 785 mm from this line.

1. Mount the installation plate on the wall with 5 screws or more.

(If mounting the unit on the concrete wall, consider using anchor bolts.)

- Always mount the installation plate horizontally by aligning the marking-off line with the thread and using a level gauge.

2. Drill the piping plate hole with $\phi 70$ mm hole-core drill.

- Line according to the arrows marked on the lower left and right side of the installation plate. The meeting point of the extended line is the centre of the hole. Another method is by putting measuring tape at position as shown in the diagram above. The hole centre is obtained by measuring the distance namely 150 mm and 125 mm for left and right hole respectively.
- Drill the piping hole at either the right or the left and the hole should be slightly slanted to the outdoor side.

10.2.3. TO DRILL A HOLE IN THE WALL AND INSTALL A SLEEVE OF PIPING

1. Insert the piping sleeve to the hole.
2. Fix the bushing to the sleeve.
3. Cut the sleeve until it extrudes about 15 mm from the wall.

Caution

When the wall is hollow, please be sure to use the sleeve for tube ass'y to prevent dangers caused by mice biting the connecting cable.

4. Finish by sealing the sleeve with putty or caulking compound at the final stage.

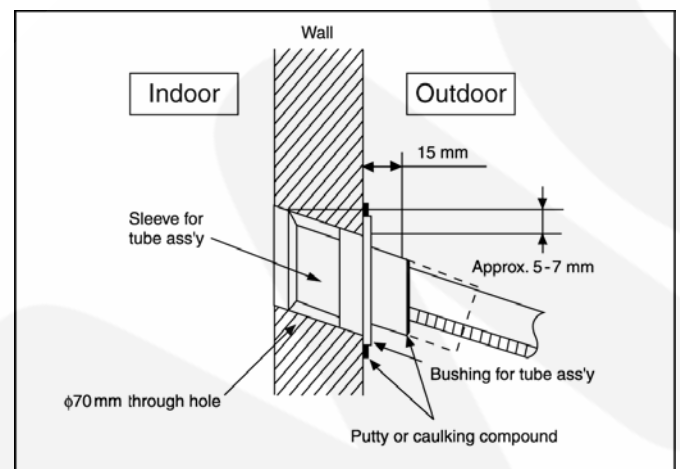

10.2.4. INDOOR UNIT INSTALLATION

1. For the right rear piping

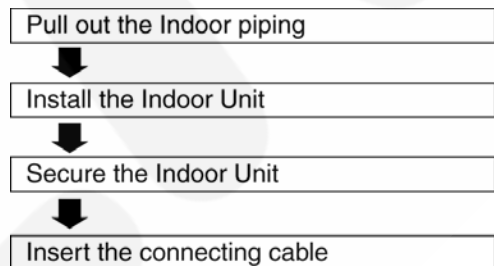

2. For the right and right bottom piping

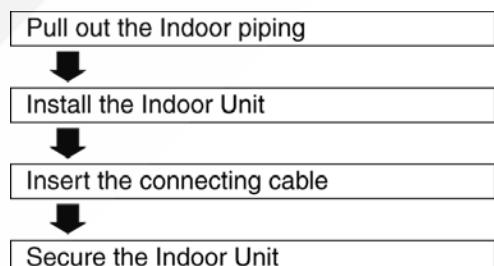

3. For the embedded piping

- Replace the drain hose
- ↓
- Bend the embedded piping
 - Use a spring bender or equivalent to bend the piping so that the piping is not crushed.
- ↓
- Install the Indoor Unit
- ↓
- Cut and flare the embedded piping
 - When determining the dimension of the piping, slide the unit all the way to the left on the installation plate.
 - Refer to the section "Cutting and flaring the piping".
- ↓
- Pull the connecting cable into Indoor Unit
 - The inside and outside connecting cable can be connected without removing the front grille.
- ↓
- Connect the piping
 - Please refer to "Connecting the piping" column in outdoor unit section. (Below steps are done after connecting the outdoor piping and gas-leakage confirmation.)
- ↓
- Insulate and finish the piping
 - Please refer to "Piping and finishing" column of outdoor section and "Insulation of piping connections" column as mentioned in Indoor/Outdoor Unit Installation.
- ↓
- Secure the Indoor Unit

Install the indoor unit

Hook the indoor unit onto the upper portion of installation plate. (Engage the indoor unit with the upper edge of the installation plate). Ensure the hooks are properly seated on the installation plate by moving it in left and right.

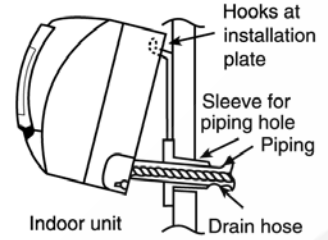

Secure the indoor unit

1. Tape the extra power supply cord in a bundle and keep it behind the chassis.
 - Ensure that the power supply cord is not clamped in between the unit's hook (2 positions) and installation plate.
2. Press the lower left and right side of the unit against the installation plate until hooks engages with their slots (sound click).

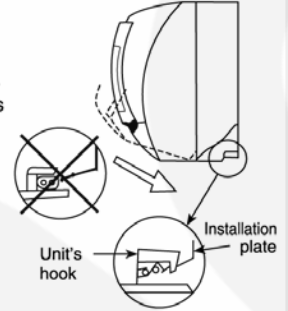

To take out the unit, push the [PUSH] marking at the bottom unit, and pull it slightly towards you to disengage the hooks from the unit.

(This can be used for left rear piping & left bottom piping also.)

Exchange the drain hose and the cap

Refer view for left piping installation

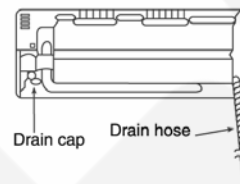

Adjust the piping slightly downwards

Pull out the piping and drain hose

Move the drain hose near to arrow mark and tape it with piping in a position as mentioned in Fig. below.

How to keep the cover

In case of the cover is cut, keep the cover at the rear of chassis as shown in the illustration for future reinstallation.

(Left, right and 2 bottom covers for piping)

Insert the connecting cable

About 7-8cm

Length of connecting cable

77cm	Gas side piping	Liquid side piping
Cable		

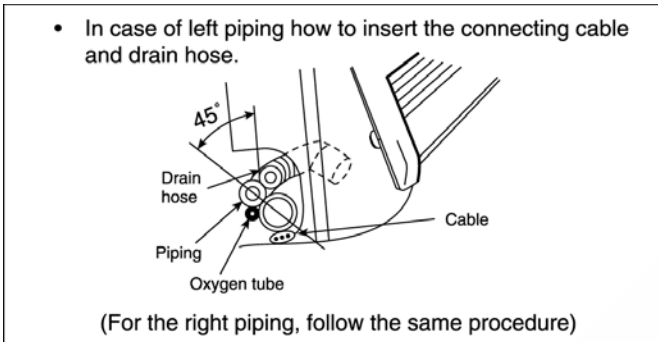
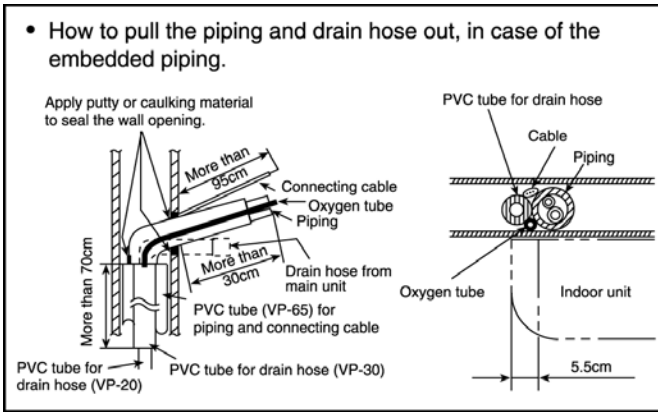

10.2.5. CONNECT THE CABLE TO THE INDOOR UNIT

- The inside and outside connecting cable can be connected without removing the front grille.
- Connecting cable between indoor unit and outdoor unit shall be approved polychloroprene sheathed 4 (XE9DK, XE12DK) × 1.5 mm² flexible cord, type designation 245 IEC 57 or heavier cord.
 - Ensure the color of wires of outdoor unit and the terminal Nos. are the same to the indoor's respectively.
 - Earth lead wire shall be longer than the other lead wires as shown in the figure for the electrical safety in case of the slipping out of the cord from the anchorage.

XE9DK, XE12DK

Terminals on the indoor unit	1	2	3	
Colour of wires	Grey	Black	Black	Black
Terminals on the outdoor unit	1	2	3	

- Secure the cable onto the control board with the holder (clamper).

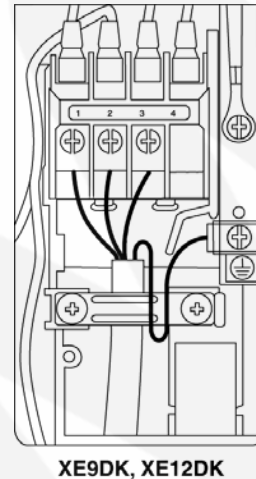

XE9DK, XE12DK

INSTALLATION OF AIR PURIFYING FILTER

- Open the front panel.
- Remove the air filters.
- Put Super Alleru-Buster filter into place as shown in illustration below.

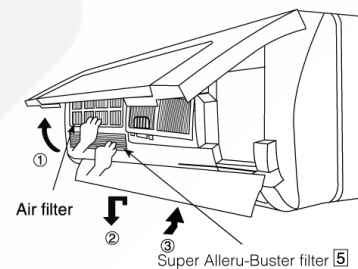

HOW TO TAKE OUT FRONT GRILLE

Please follow the steps below to take out front grille if necessary such as when servicing.

1. Set the vertical airflow direction louver to the horizontal position.
2. Slide down the two caps on the front grille as shown in the illustration below, and then remove the two mounting screws.
3. Pull the lower section of the front grille towards you to remove the front grille.

Caution

When reinstalling the front grille, first set the vertical airflow direction louver to the horizontal position and then carry out above steps 2 - 3 in the reverse order.

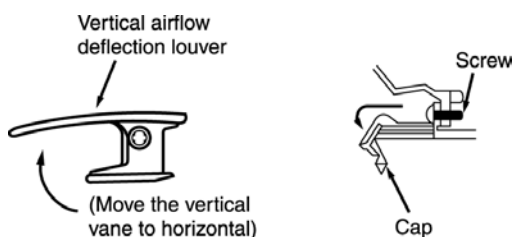

AUTO SWITCH OPERATION

The below operations will be performed by pressing the "AUTO" switch.

1. AUTO OPERATION MODE

The Auto operation will be activated immediately once the Auto Switch is pressed.

2. TEST RUN OPERATION (FOR PUMP DOWN/SERVICING PURPOSE)

The Test Run operation will be activated if the Auto Switch is pressed continuously for more than 5 sec. to below 10 sec.. A "pep" sound will occur at the fifth sec., in order to identify the starting of Test Run operation.

3. HEATING TRIAL OPERATION

Press the AUTO switch continuously for more than 8 sec. to below 11 sec. and release when a "pep pep" sound is occurred at eight sec.. (However, a "pep" sound is occurred at fifth sec..)

4. REMOTE CONTROLLER RECEIVING SOUND ON/OFF

The ON/OFF of Remote Controller receiving sound can be change over by following steps:

- a. Press "AUTO" Switch continuously for more than 16 sec. to below 21 sec. A "pep", "pep", "pep" sound will occur at the sixteenth sec..
- b. Press the "Check" button once to select remote control. A "pep" sound will occur.
- c. Press the "AUTO" switch once to select remote control receiveing sound ON/OFF. A "pep" sound indicates receiving sound ON, and a "pep" sound indicates receiving sound OFF.

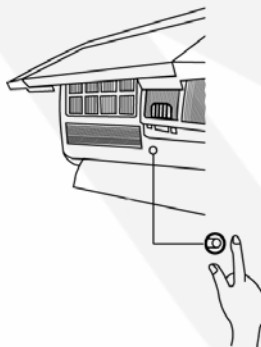

10.3. Outdoor Unit

10.3.1. SELECT THE BEST LOCATION (Refer to “Select the best location” section)

10.3.2. INSTALL THE OUTDOOR UNIT

- After selecting the best location, start installation according to Indoor/Outdoor Unit Installation Diagram.
1. Fix the unit on concrete or rigid frame firmly and horizontally by bolt nut. ($\phi 10$ mm).
 2. When installing at roof, please consider strong wind and earthquake. Please fasten the installation stand firmly with bolt or nails.

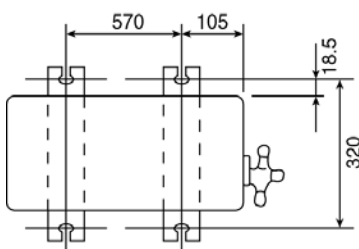

10.3.3. CONNECTING THE PIPING

Connecting The Piping To Indoor Unit

Please make flare after inserting flare nut (locate at joint portion of tube assembly) onto the copper pipe. (In case of using long piping)

Connect the piping

- Align the center of piping and sufficiently tighten the flare nut with fingers.
- Further tighten the flare nut with torque wrench in specified torque as stated in the table.

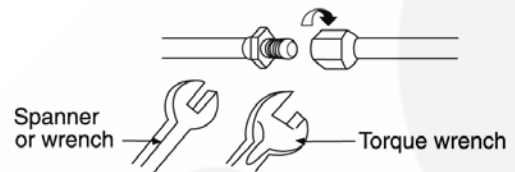

MODEL	Piping size (Torque)	
	Gas	Liquid
XE9DK	3/8" (42 N.m)	1/4" (18 N.m)
XE12DK	1/2" (55 N.m)	1/4" (18 N.m)

Connecting The Piping To Outdoor Unit

Decide piping length and then cut by using pipe cutter. Remove burrs from cut edge. Make flare after inserting the flare nut (located at valve) onto the copper pipe.

Align center of piping to valves and then tighten with torque wrench to the specified torque as stated in the table.

Cutting And Flaring The Piping

1. Please cut using pipe cutter and then remove the burrs.
2. Remove the burrs by using reamer. If burrs is not removed, gas leakage may be caused.
Turn the piping end down to avoid the metal powder entering the pipe.
3. Please make flare after inserting the flare nut onto the copper pipes.

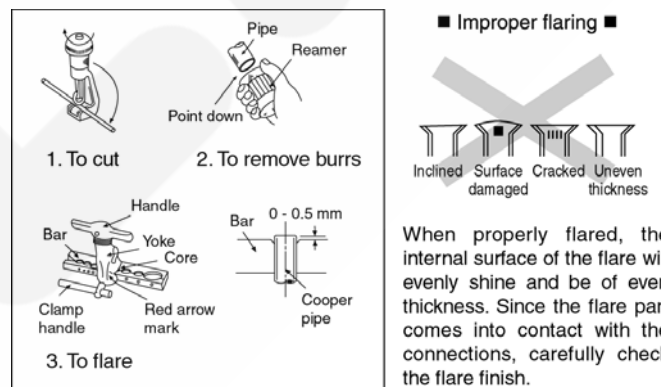

10.3.4. EVACUATION OF THE EQUIPMENT (FOR EUROPE & OCEANIA DESTINATION)

WHEN INSTALLING AN AIR CONDITIONAL, BE SURE TO EVACUTE THE AIR INSIDE THE INDOOR UNIT AND PIPES in the following procedure.

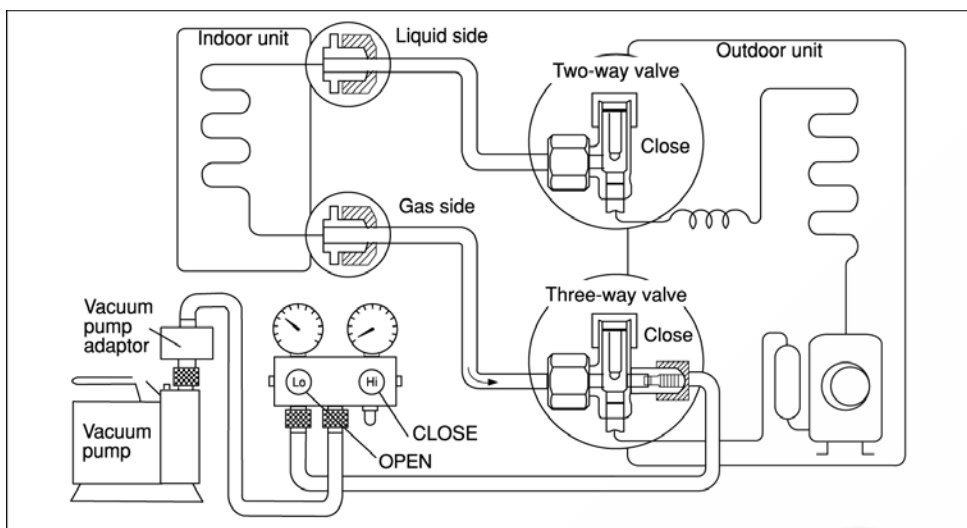

1. Connect a charging hose with a push pin to the Low and High side of a charging set and the service port of the 3-way valve.
 - Be sure to connect the end of the charging hose with the push pin to the service port.
2. Connect the center hose of the charging set to a vacuum pump with check valve, or vacuum pump and vacuum pump adaptor.
3. Turn on the power switch of the vacuum pump and make sure that the needle in the gauge moves from 0 cmHg (0 MPa) to -76 cmHg (-0.1 MPa). Then evacuate the air approximately ten minutes.
4. Close the Low side valve of the charging set the turn off the vacuum pump. Make sure that the needle in the gauge does not move after approximately five minutes.

Note: BE SURE TO FOLLOW THIS PROCEDURE INORDER TO AVOID REFRIGERANT GAS LEAKAGE.
5. Disconnect the charging hose from vacuum pump and from the service port of the 3-way valve.
6. Tighten the service port caps of the 3-way valve at a torque of 18 N.m with a torque wrench.
7. Remove the valve caps of both of the 2-way valve and 3-way valve. Position both of the valves to "OPEN" using a hexagonal wrench (4 mm).
8. Mount valve caps onto the 2-way valve and the 3-way valve.
 - Be sure to check for gas leakage.

Caution

- If gauge needle does not move from 0 cmHg (0 MPa) to -76 cmHg (-0.1 MPa), in step 3 above take the following measure:
- If the leak stops when the piping connections are tightened further, continue working from step 3.
- If the leak does not stop when the connections are retightened, repair the location of leak.
- Do not release refrigerant during piping work for installation and reinstallation. Take care of the liquid refrigerant, it may cause frostbite.

10.3.5. CONNECT THE CABLE TO THE OUTDOOR UNIT

1. Remove the control board cover from the unit by loosening the screw.
2. Connecting cable between indoor unit and outdoor unit shall be approved polychloroprene sheathed 4 (XE9DK, XE12DK) × 1.5 mm² flexible cord, type designation 245 IEC 57 or heavier cord.

XE9DK, XE12DK

Terminals on the indoor unit	1	2	3	
Colour of wires				
Terminals on the outdoor unit	1	2	3	

3. Secure the cable onto the control board with the holder (clammer).
4. Attach the control board cover back to the original position with the screw.

10.3.6. PIPE INSULATION

1. Please carry out insulation at pipe connection portion as mentioned in Indoor/Outdoor Unit Installation Diagram. Please wrap the insulated piping end to prevent water from going inside the piping.
2. If drain hose or connecting piping is in the room (where dew may form), please increase the insulation by using POLY-E FOAM with thickness 6 mm or above.

DISPOSAL OF OUTDOOR UNIT DRAIN WATER

- If a drain elbow is used, the unit should be placed on a stand which is taller than 3 cm.
- If the unit is used in an area where temperature falls below 0°C for 2 or 3 days in succession, it is recommended not to use a drain elbow, for the drain water freezes and the fan will not rotate.

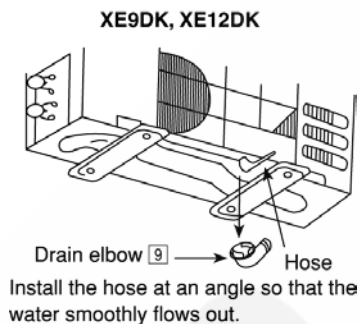

- Measure the temperature of the intake and discharge air.
- Ensure the difference between the intake temperature and the discharge is more than 8°C.

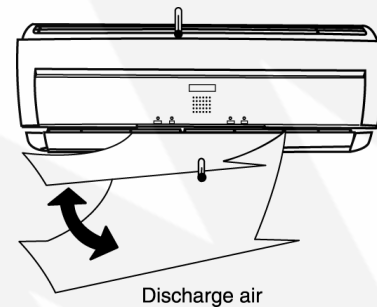

CHECK THE DRAINAGE

- Open front panel and remove air filters. (Drainage checking can be carried out without removing the front grille.)
- Pour a glass of water into the drain tray styrofoam.
- Ensure that water flows out from drain hose of the indoor unit.

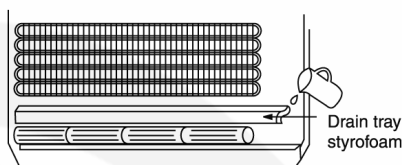

EVALUATION OF THE PERFORMANCE

- Operate the unit at cooling operation mode for fifteen minutes or more.

CHECK ITEMS

- Is there any gas leakage at flare nut connection?
- Has the heat insulation been carried out at flare nut connection?
- Is the connecting cable being fixed to terminal board firmly?
- Is the connecting cable being clamped firmly?
- Is the drainage OK?
(Refer to "Check the drainage" section)
- Is the earth wire connection properly done?
- Is the indoor unit properly hooked to the installation plate?
- Is the power supply voltage complied with rated value?
- Is there any abnormal sound?
- Is the cooling operation normal?
- Is the thermostat operation normal?
- Is the remote control's LCD operation normal?
- Is the air purifying filter installed?

10.3.7. OXYGEN TUBE CONNECTION

(Precautions: Install outdoor unit at a location free from foul smell or poisonous gas. Otherwise smell or gas may enter the room when the oxygen is in operation.)

AFTER PIPE CONNECTION, CONNECT THE OXYGEN TUBE.

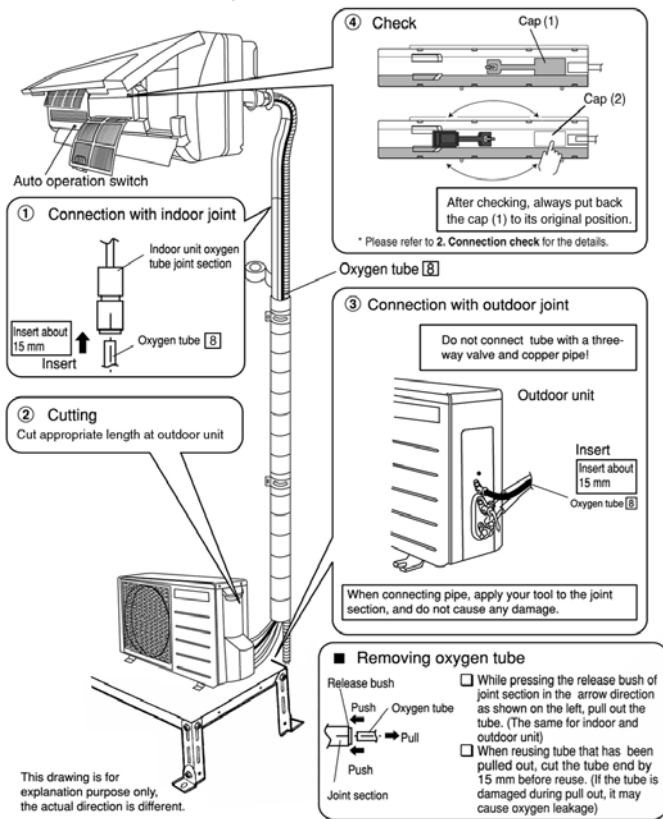

Precautions during oxygen tube connection

1. Tube allowable length and height difference is the same as pipes.
2. Tube should be pulled without folding it along the path of refrigerant pipe, providing sufficient allowance and cut to length.
 - If there is no allowance, tube length will contract when temperature changes and it may cause trouble.
 - On the other hand, tube length used without cutting and **in the form of loop** too should be avoided.
3. When the tube is passed through the pipe hole, it should not form the inner wall of the pipe bends.

The tube may be pressed to the corner of the hold and crushed.
4. Cutting of tube should be done with cutter or knife, **cutting surface should be straight and even**.

Finishing should be done and leave no scratches behind.
5. Tube end's last 15 mm (the section to be inserted to the joint during connection) should be free from any damages.
6. Take note that the inside of tube should be **free from stones, dirt, dust, and other impurities**.

1. Oxygen tube connection

- Insert oxygen tube ⑧ into the joint section of indoor unit till it **fully reaches its limit (about 15 mm)**.
- If the insert does not fully reach the limit, oxygen may leak out from the joint causing abnormal noise.
- In both indoor and outdoor unit, the tube inserted will be locked inside the joint by the stopper, and the job is

complete. To make sure that it's done properly, pull out lightly to check if can be removed.

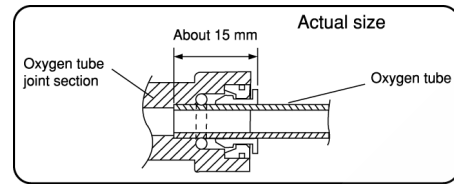

2. Connection check

- **Do connection check after normal running of cooling/heating has been confirmed during trial operation.**

(You cannot do proper oxygen tube connection check before normal running has been confirmed during trial operation).

- Operate according to the sequence listed below, and check tube connection.

1. Open the cap (1) to check.
2. Put your ear close to the window to listen if there is oxygen flowing out (a shuuuu sound).

If it's hard to hear, push the cap (2) in the window with your finger, then release your finger. The sound of flow will be louder and easier to hear.

(If there is no air release, the cause may be tube collapse, or the insert at joint section not proper. Check again and make correction if found not properly done.)

3. After checking, **make sure that you push down the cap (1) and return to its original position.**

(If it is not returned to its position, it may cause abnormal noise.)

3. Finishing

- Finishing should be carried out for pipe and drain hose.
- Refer to 10.3.6 Pipe insulation of outdoor unit.

11 Installation and Servicing Air Conditioner Using R410A

11.1. Outline

11.1.1. About R410A Refrigerant

1. Converting air conditioners to R410A

Since it was declared in 1974 that chlorofluorocarbons (CFC), hydro chlorofluorocarbons (HCFC) and other substances pose a destructive danger to the ozone layer in the earth's upper stratosphere (20 to 40 km above the earth), measures have been taken around the world to prevent this destruction.

The R22 refrigerant which has conventionally been used in ACs is an HCFC refrigerant and, therefore, possesses this ozone-destroying potential. International regulations (the Montreal Protocol on Ozone-Damaging Substances) and the domestic laws of various countries call for the early substitution of R22 by a refrigerant which will not harm the ozone layer.

- In ACs, the HFC refrigerant which has become the mainstream alternative is called R410A. Compared with R22, the pressure of R410A is approximately 1.6 times as high at the same refrigerant temperature, but the energy efficiency is about the same. Consisting of hydrogen (H), fluorine (F) and carbon (C), R410A is an HFC refrigerant. Another typical HFC refrigerant is R407C. While the energy efficiency of R407C is somewhat inferior to that of R410A, it offers the advantage of having pressure characteristics which are about the same as those of R22, and is used mainly in packaged ACs.

2. The characteristics of HFC (R410A) refrigerants

a. Chemical characteristics

The chemical characteristics of R410A are similar to those of R22 in that both are chemically stable, non-flammable refrigerants with low toxicity.

However, just like R22, the specific gravity of R410A gas is heavier than that of air. Because of this, it can cause an oxygen deficiency if it leaks into a closed room since it collects in the lower area of the room. It also generates toxic gas when it is directly exposed to a flame, so it must be used in a well ventilated environment where it will not collect.

Table 1 Physical comparison of R410A and R22

	R410A	R22
Composition (wt%)	R32/R125 (50/50)	R22 (100)
Boiling point (°C)	-51.4	-40.8
Vaporizing pressure (25°C)	1.56 Mpa (15.9 kgf/cm ²)	0.94 Mpa (9.6 kgf/cm ²)
Saturated vapor density	64.0 kg/m ³	44.4 kg/m ³
Flammability	Non-flammable	Non-flammable
Ozone-destroying point (ODP)	0	0.055
Global-warming point (GWP)	1730	1700

b. Compositional change (pseudo-azeotropic characteristics)

R410A is a pseudo-azeotropic mixture comprising the two components R32 and R125. Multi-component refrigerants with these chemical characteristics exhibit little compositional change even from phase changes due to vaporization (or condensation), which means that there is little change in the circulating refrigerant composition even when the refrigerant leaks from the gaseous section of the piping.

Accordingly, R410A can be handled in almost the same manner as the single-component refrigerant R22. However, when charging, because there is a slight change in composition between the gas phase and the liquid phase inside a cylinder or other container, charging should basically begin with the liquid side.

c. Pressure characteristics

As seen in Table 2, the gas pressure of R410A is approximately 1.6 times as high as that of R22 at the same refrigerant temperature, which means that special R410A tools and materials with high-pressure specifications must be used for all refrigerant piping work and servicing.

Table 2 Comparison of R410A and R22 saturated vapor density

Refrigerant Temperature (°C)	Unit: MPa	
	R410A	R22
-20	0.30	0.14
0	0.70	0.40
20	1.35	0.81
40	2.32	1.43
60	3.73	2.33
65	4.15	2.60

d. R410A refrigerating machine oil

Conventionally, mineral oil or a synthetic oil such as alkylbenzene has been used for R22 refrigerating machine oil. Because of the poor compatibility between R410A and conventional oils like mineral oil, however, there is a tendency for the refrigerating machine oil to collect in the refrigerating cycle. For this reason, polyester and other synthetic oils which have a high compatibility with R410A are used as refrigerating machine oil.

Because of the high hygroscopic property of synthetic oil, more care must be taken in its handling than was necessary with conventional refrigerating machine oils. Also, these synthetic oils will degrade if mixed with mineral oil or alkylbenzene, causing clogging in capillary tubes or compressor malfunction. Do not mix them under any circumstances.

11.1.2. Safety Measures When Installing/Serviceing Refrigerant Piping

Cause the gas pressure of R410A is approximately 1.6 times as high as that of R22, a mistake in installation or servicing could result in a major accident. It is essential that you use R410A tools and materials, and that you observe the following precautions to ensure safety.

1. Do not use any refrigerant other than R410A in ACs that have been used with R410A.
2. If any refrigerant gas leaks while you are working, ventilate the room. Toxic gas may be generated if refrigerant gas is exposed to a direct flame.
3. When installing or transferring an AC, do not allow any air or substance other than R410A to mix into the refrigeration cycle. If it does, the pressure in the refrigeration cycle can become abnormally high, possibly causing an explosion and/or injury.
4. After finishing the installation, check to make sure there is no refrigerant gas leaking.
5. When installing or transferring an AC, follow the instructions in the installation instructions carefully. Incorrect installation can result in an abnormal refrigeration cycle or water leakage, electric shock, fire, etc.
6. Do not perform any alterations on the AC unit under any circumstances. Have all repair work done by a specialist. Incorrect repairs can result in a water leakage, electric shock, fire, etc.

11.2. Tools For Installing/Serviceing Refrigerant Piping

11.2.1. Necessary Tools

In order to prevent an R410A AC from mistakenly being charged with any other refrigerant, the diameter of the 3-way valve service port on the outdoor unit has been changed. Also, to increase its ability to withstand pressure, the opposing dimensions have been changed for the refrigerant pipe flaring size and flare nut. Accordingly, when installing or servicing refrigerant piping, you must have both the R410A and ordinary tools listed below.

Table 3 Tools for installation, transferring or replacement

Type of work	Ordinary tools	R410A tools
Flaring	Flaring tool (clutch type), pipe cutter, reamer	Copper pipe gauge for clearance Adjustment, flaring tool (clutch type)*1)
Bending, connecting pipes	Torque wrench (nominal diameter 1/4, 3/8, 1/2). Fixed spanner (opposing sides 12 mm, 17 mm, 19 mm). Adjustable wrench, Spring bender	
Air purging	Vacuum pump. Hexagonal wrench (opposing sides 4 mm)	Manifold gauge, charging hose, vacuum pump adaptor
Gas leak inspection	Gas leak inspection fluid or soapy water	Electric gas leak detector for HFC refrigerant*2)

*1) You can use the conventional (R22) flaring tool. If you need to buy a new tool, buy the R410A type.

*2) Use when it is necessary to detect small gas leaks.

For other installation work, you should have the usual tools, such as screwdrivers (+,-), a metal-cutting saw, an electrical drill, a hole core drill (65 or 70 dia.), a tape measure, a level, a thermometer, a clamp meter, an insulation tester, a voltmeter, etc.

Table 4 Tools for serving

Type of work	Ordinary tools	R410A tools
Refrigerant charging		Electronic scale for refrigerant charging. Refrigerant cylinder. Charging orifice and packing for refrigerant cylinder
Brazing (Replacing refrigerating cycle part*1)	Nitrogen blow set (be sure to use nitrogen blowing for all brazing), and brazing machine	

*1) Always replace the dryer of the outdoor unit at the same time. The replacement dryer is wrapped in a vacuum pack. Replace it last among the refrigerating cycle parts. Start brazing as soon as you have opened the vacuum pack, and begin the vacuuming operation within 2 hours.

11.2.2. R410A Tools

1. Copper tube gauge for clearance adjustment
(used when flaring with the conventional flaring tool (clutch type))

- This gauge makes it easy to set the clearance for the copper tube to 1.0-1.5 mm from the clamp bar of the flaring tool.

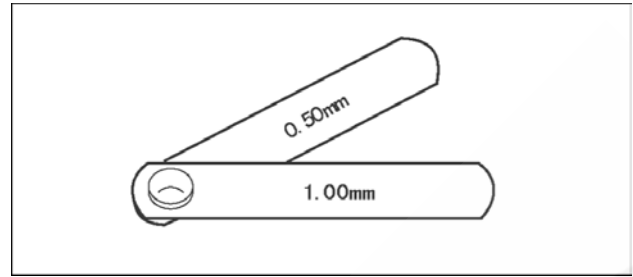

Fig. 1 Copper tube gauge for clearance adjustment

2. Flaring tool (clutch type)

- In the R410A flaring tool, the receiving hole for the clamp bar is enlarged so the clearance from the clamp bar can be set to 0-0.5 mm, and the spring inside the tool is strengthened to increase the strength of the pipe-expanding torque. This flaring tools can also be used with R22 piping, so we recommend that you select it if you are buying a new flaring tool.

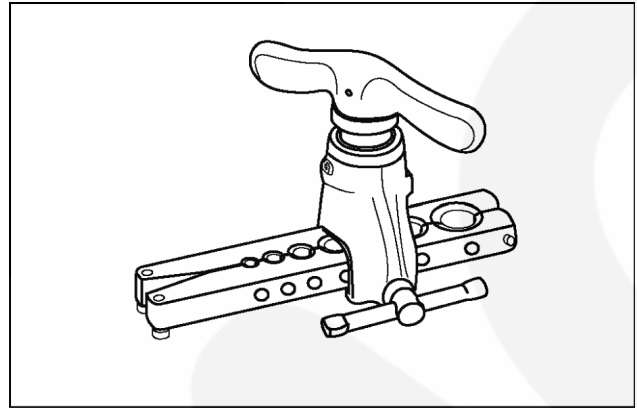

Fig. 2 Flaring tool (clutch type)

3. Torque wrenches

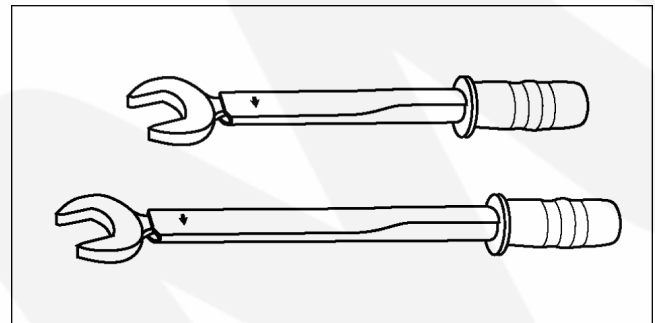

Fig. 3 Torque wrenches

Table 5

	Conventional wrenches	R410A wrenches
For 1/4 (opposite side x torque)	17 mm x 18 N.m (180 kgf.cm)	17 mm x 18 N.m (180 kgf.cm)
For 3/8 (opposite side x torque)	22 mm x 42 N.m (420 kgf.cm)	22 mm x 42 N.m (420 kgf.cm)
For 1/2 (opposite side x torque)	24 mm x 55 N.m (550 kgf.cm)	26 mm x 55 N.m (550 kgf.cm)

4. Manifold gauge

- Because the pressure is higher for the R410A type, the conventional type cannot be used.

Table 6 Difference between R410A and conventional high/low-pressure gauges

	Conventional gauges	R410A gauges
High-pressure gauge (red)	-76 cmHg - 35 kgf/cm ³	-0.1 - 5.3 Mpa -76 cmHg - 53 kgf/cm ³
Low-pressure gauge (blue)	-76 cmHg - 17 kgf/cm ³	-0.1 - 3.8 Mpa -76 cmHg - 38 kgf/cm ³

- The shape of the manifold ports has been changed to prevent the possibility of mistakenly charging with another type of refrigerant.

Table 7 Difference between R410A and conventional manifold port size

	Conventional gauges	R410A gauges
Port size	7/16 UNF 20 threads	1/2 UNF 20 threads

5. Charging hose

- The pressure resistance of the charging hose has been raised to match the higher pressure of R410A. The hose material has also been changed to suit HFC use, and the size of the fitting has been changed to match the manifold ports.

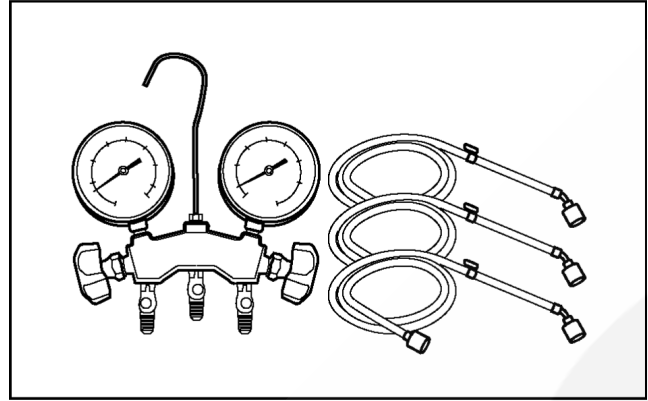

Fig. 4 Manifold gauge charging hose

Table 8 Difference between R410A and conventional charging hoses

		Conventional hoses	R410A hoses
Pressure resistance	Working pressure	3.4 MPa (35 kgf/cm ³)	5.1 MPa (52 kgf/cm ³)
	Bursting pressure	17.2 MPa (175 kgf/cm ³)	27.4 MPa (280 kgf/cm ³)
Material		NBR rubber	HNBR rubber Nylon coating inside

6. Vacuum pump adaptor

- When using a vacuum pump for R410A, it is necessary to install an electromagnetic valve to prevent the vacuum pump oil from flowing back into the charging hose. The vacuum pump adaptor is installed for that purpose. If the vacuum pump oil (mineral oil) becomes mixed with R410A, it will damage the unit.

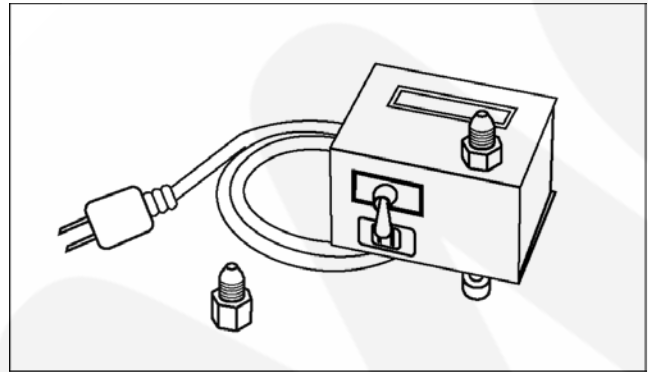

Fig. 5 Vacuum pump adaptor

7. Electric gas leak detector for HFC refrigerant

- The leak detector and halide torch that were used with CFC and HCFC cannot be used with R410A (because there is no chlorine in the refrigerant).
- The present R134a leak detector can be used, but the detection sensitivity will be lower (setting the sensitivity for R134a at 1, the level for R410A will drop to 0.6).
- For detecting small amounts of gas leakage, use the electric gas leak detector for HFC refrigerant. (Detection sensitivity with R410A is about 23 g/year).

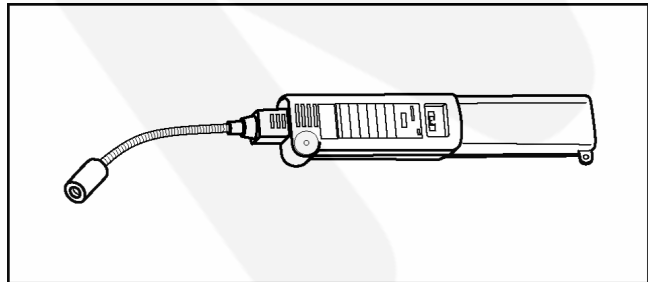

Fig. 6 Electric gas leak detector for HFC refrigerant

8. Electronic scale for refrigerant charging

- Because of the high pressure and fast vaporizing speed of R410A, the refrigerant cannot be held in a liquid phase inside the charging cylinder when charging is done using the charging cylinder method, causing bubbles to form in the measurement scale glass and making it difficult to see the reading. (Naturally, the conventional R22 charging cylinder cannot be used because of the differences in the pressure resistance, scale gradation, connecting port size, etc.)
- The electronic scale has been strengthened by using a structure in which the weight detector for the refrigerant cylinder is held by four supports. It is also equipped with two connection ports, one for R22 (7/16 UNF, 20 threads) and one for R410A (1/2 UNF, 20 threads), so it can also be used for conventional refrigerant charging.
- There are two types of electronic scales, one for 10-kg cylinders and one for 20-kg cylinders. (The 10-kg cylinder is recommended.)

Refrigerant charging is done manually by opening and closing the valve.

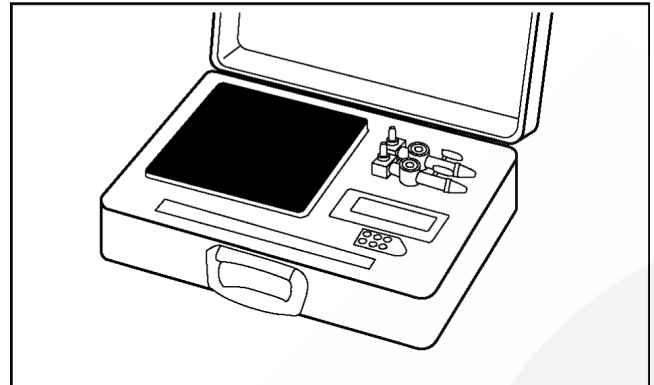

Fig. 7 Electronic scale for refrigerant charging

9. Refrigerant cylinders

- The R410A cylinders are labeled with the refrigerant name, and the coating color of the cylinder protector is pink, which is the color stipulated by ARI of the U.S.
- Cylinders equipped with a siphon tube are available to allow the cylinder to stand upright for liquid refrigerant charging.



Fig. 8 Refrigerant cylinders

10. Charging orifice and packing for refrigerant cylinders

- The charging orifice must match the size of the charging hose fitting (1/2 UNF, 20 threads).
- The packing must also be made of an HFC-resistant material.

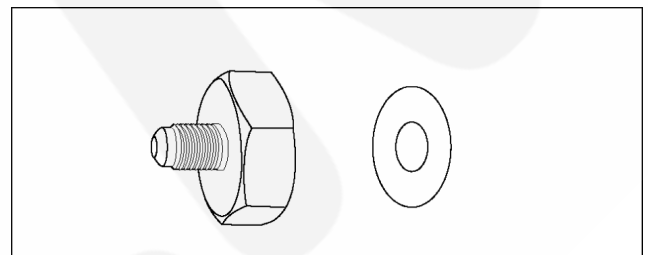

Fig. 9 Charging orifice and packing

11.2.3. R410A Tools Which Are Usable for R22 Models

Table 9 R410A tools which are usable for R22 models

	R410A tools	Usable for R22 models
(1)	Copper tube gauge for clearance adjustment	OK
(2)	Flaring tool (clutch type)	OK
(3)	Manifold gauge	NG
(4)	Charging hose	NG
(5)	Vacuum pump adaptor	OK
(6)	Electric gas leak detector for HFC refrigerant	NG
(7)	Electronic scale for refrigerant charging	OK
(8)	Refrigerant cylinder	NG
(9)	Charging orifice and packing for refrigerant cylinder	NG

11.3. Refrigerant Piping Work

11.3.1. Piping Materials

It is recommended that you use copper and copper alloy jointless pipes with a maximum oil adherence of 40 mg/10m. Do not use pipes that are crushed, deformed, or discolored (especially the inside surface). If these inferior pipes are used, impurities may clog the expansion valves or capillaries.

Because the pressure of ACs using R410A is higher than those using R22, it is essential that you select materials that are appropriate for these standards.

The thickness of the copper tubing used for R410A is shown in Table 10. Please be aware that tubing with a thickness of only 0.7 mm is also available on the market, but this should never be used.

Table 10 Copper tube thickness (mm)

Soft pipe		Thickness (mm)	
Nominal diameter	Outside diameter (mm)	R410A	(Reference) R22
1/4	6.35	0.80	0.80
3/8	9.52	0.80	0.80
1/2	12.7	0.80	0.80

11.3.2. Processing and Connecting Piping Materials

When working with refrigerant piping, the following points must be carefully observed: no moisture or dust must be allowed to enter the piping, and there must be no refrigerant leaks.

1. Procedure and precautions for flaring work

a. Cut the pipe

Use a pipe cutter, and cut slowly so the pipe will not be deformed.

b. Remove burrs and clean shavings from the cut surface

If the shape of the pipe end is poor after removing burrs, or if shavings adhere to the flared area, it may lead to refrigerant leaks.

To prevent this, turn the cut surface downward and remove burrs, then clean the surface, carefully.

c. Insert the flare nut (be sure to use the same nut that is used on the AC unit)

d. Flaring

Check the clamp bar and the cleanliness of the copper pipe.

Be sure to use the clamp bar to do the flaring with accuracy. Use either an R410A flaring tool, or a conventional flaring tool. Flaring tools come in different sizes, so be sure to check the size before using. When using a conventional flaring tool, use the copper pipe gauge for clearance adjustment, etc., to ensure the correct A dimension (see Fig. 10)

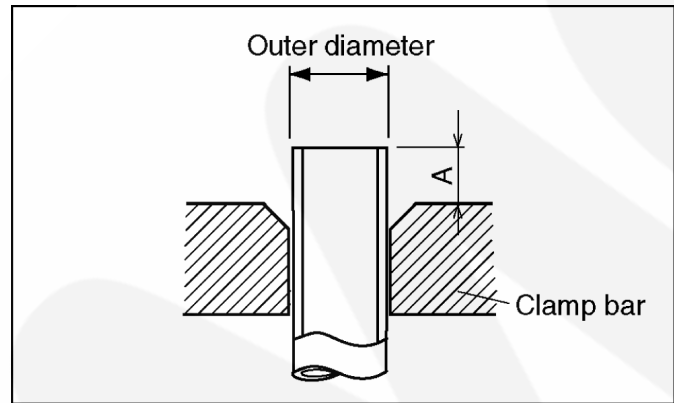

Fig. 10 Flaring dimensions

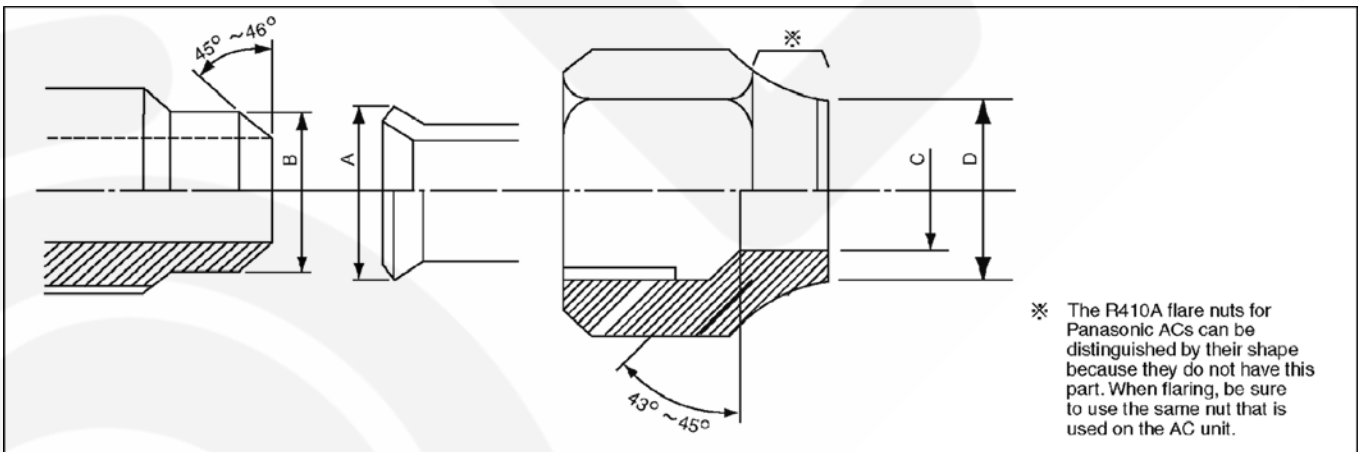

Fig. 11 Relation between the flare nut structure and flaring tool end

Table 11 R410A flaring dimensions

Nominal diameter	Outside diameter (mm)	Wall thickness (mm)	A (mm)		
			R410A flaring tool, clutch type	Conventional flaring tool	
				Clutch type	Wing-nut type
1/4	6.35	0.8	0 - 0.5	1.0 - 1.5	1.5 - 2.0
3/8	9.52	0.8	0 - 0.5	1.0 - 1.5	1.5 - 2.0
1/2	12.70	0.8	0 - 0.5	1.0 - 1.5	2.0 - 2.5

Table 12 R22 flaring dimensions

Nominal diameter	Outside diameter (mm)	Wall thickness (mm)	A (mm)		
			R410A flaring tool, clutch type	Conventional flaring tool	
				Clutch type	Wing-nut type
1/4	6.35	0.8	0 - 0.5	0.5 - 1.0	1.0 - 1.5
3/8	9.52	0.8	0 - 0.5	0.5 - 1.0	1.0 - 1.5
1/2	12.70	0.8	0 - 0.5	0.5 - 1.0	1.5 - 2.0

Table 13 R410A flare and flare nut dimensions Unit: mm

Nominal diameter	Outside diameter (mm)	Wall thickness (mm)	A +0, -0.4	B dimension	C dimension	D dimension	Flare nut width
1/4	6.35	0.8	9.1	9.2	6.5	13	17
3/8	9.52	0.8	13.2	13.5	9.7	20	22
1/2	12.70	0.8	16.6	16.0	12.9	23	26

Table 14 R22 flare and flare nut dimensions Unit: mm

Nominal diameter	Outside diameter (mm)	Wall thickness (mm)	A +0, -0.4	B dimension	C dimension	D dimension	Flare nut width
1/4	6.35	0.8	9.0	9.2	6.5	13	17
3/8	9.52	0.8	13.0	13.5	9.7	20	22
1/2	12.70	0.8	16.2	16.0	12.9	20	24

2. Procedure and precautions for flare connection

- Check to make sure there is no scratches, dust, etc., on the flare and union.
- Align the flared surface with the axial center of the union.
- Use a torque wrench, and tighten to the specified torque. The tightening torque for R410A is the same as the conventional torque value for R22. Be careful, because if the torque is too weak, it may lead to a gas leak. If it is too strong, it may split the flare nut or make it impossible to remove the flare nut.

Table 15 R410A tightening torque

Nominal diameter	Outside diameter (mm)	Tightening torque N.m (kgf.cm)	Torque wrench tightening torque N.m (kgf.cm)
1/4	6.35	14 - 18 (140 - 180)	18 (180)
3/8	9.52	33 - 42 (330 - 420)	42 (420)
1/2	12.70	55 (550)	55 (550)

11.3.3. Storing and Managing Piping Materials

1. Types of piping and their storage

The following is a general classification of the refrigerant pipe materials used for ACs.

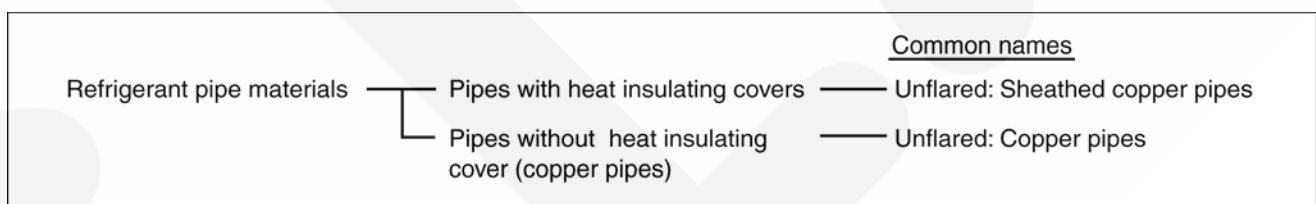

Because the gas pressure of R410A is approximately 1.6 times as high as that of R22, copper pipes with the thickness shown in Table 10, and with minimal impurities must be used. Care must also be taken during storage to ensure that pipes are not crushed, deformed, or scratched, and that no dust, moisture or other substance enters the pipe interior. When storing sheathed copper pipes or plain copper pipes, seal the openings by pinching or taping them securely.

2. Makings and management

a. Sheathed copper pipes and copper-element pipes

When using these pipes, check to make sure that they are the stipulated thickness. For flare nuts, be sure to use the same nut that is used on the AC unit.

b. Copper pipes

Use only copper pipes with the thickness given in table 10, and with minimal impurities. Because the surface of the pipe is exposed, you should take special care, and also take measures such as marking the pipes to make sure they are easily distinguished from other piping materials, to prevent mistaken use.

3. Precautions during refrigerant piping work

Take the following precautions on-site when connecting pipes. (Keep in mind that the need to control the entry of moisture and dust is even more important than in conventional piping).

- a. Keep the open ends of all pipes sealed until connection with AC equipment is complete.
- b. Take special care when doing piping work on rainy days. The entering of moisture will degrade the refrigerating machine oil, and lead to malfunctions in the equipment.
- c. Complete all pipe connections in as short a time as possible. If the pipe must be left standing for a long time after removing the seal, it must be thoroughly purged with nitrogen, or dried with a vacuum pump.

11.4. Installation, Transferring, Servicing

11.4.1. Inspecting Gas Leaks with a Vacuum Pump for New Installations (Using New Refrigerant Piping)

1. From the viewpoint of protecting the global environment, please do not release refrigerant into the atmosphere.
 - a. Connect the projecting side (pin-pushing side) of the charging hose for the manifold gauge to the service port of the 3-way valve. (1)
 - b. Fully open the handle Lo of the manifold gauge and run the vacuum pump. (2) (If the needle of the low-pressure gauge instantly reaches vacuum, re-check step a.)
 - c. Continue the vacuum process for at least 15 minutes, then check to make sure the low-pressure gauge has reached -0.1 MPa (-76 cmHg). Once the vacuum process has finished, fully close the handle Lo of the manifold gauge and stop the vacuum pump operation, then remove the charging hose that is connected to the vacuum pump adaptor. (Leave the unit in that condition for 1-2 minutes, and make sure that the needle of the manifold gauge does not return.) (2) and (3)
 - d. Turn the valve stem of the 2-way valve 90° counter-clockwise to open it, then, after 10 seconds, close it and inspect for a gas leak (4)
 - e. Remove the charging hose from the 3-way valve service port, then open both the 2-way valve and 3-way valve. (1) (4) (Turn the valve stem in the counter-clockwise direction until it gently makes contact. Do not turn it forcefully).
 - f. Tighten the service port cap with a torque wrench (18 N.m (1.8 kgf.m)). (5) Then tighten the 2-way valve and 3-way valve caps with a torque wrench (42 N.m (4.2 kgf.m)) or (55 N.m (5.5 kgf.m)). (6)
 - g. After attaching each of the caps, inspect for a gas leak around the cap area. (5) (6)

Precautions

- Be sure to read the instructions for the vacuum pump, vacuum pump adaptor and manifold gauge prior to use, and follow the instructions carefully.
- Make sure that the vacuum pump is filled with oil up to the designated line on the oil gauge.
- The gas pressure back flow prevention valve on the charging hose is generally open during use. When you are removing the charging hose from the service port, it will come off more easily if you close this valve.

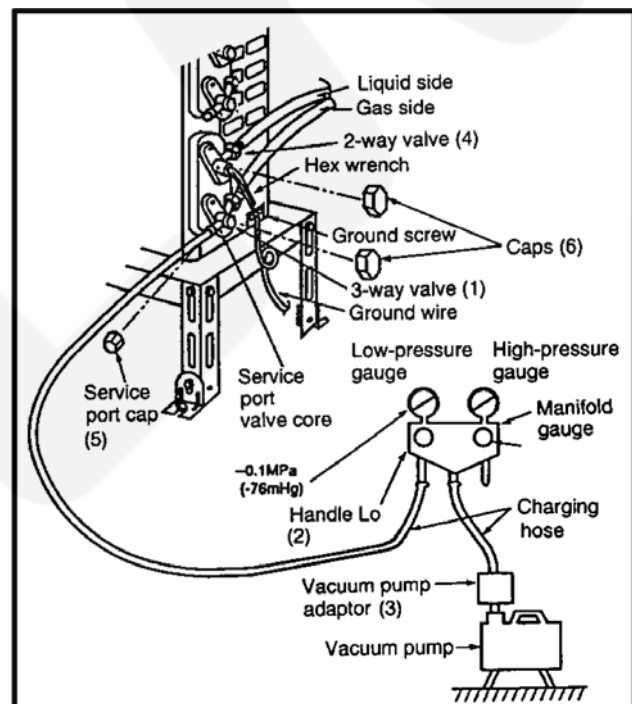

Fig. 12 Vacuum pump air purging configuration

11.4.2. Transferring (Using New Refrigerant Piping)

1. Removing the unit

a. Collecting the refrigerant into the outdoor unit by pumping down

The refrigerant can be collected into the outdoor unit (pumping down) by pressing the TEST RUN button, even when the temperature of the room is low.

- Check to make sure that the valve stems of the 2-way valve and 3-way valve have been opened by turning them counter-clockwise. (Remove the valve stem caps and check to see that the valve stems are fully opened position. Always use a hex wrench (with 4-mm opposing sides) to operate the valve stems.)
- Press the TEST RUN button on the indoor unit, and allow preliminary operation for 5-6 minutes. (TEST RUN mode)
- After stopping the operation, let the unit sit for about 3 minutes, then close the 2-way valve by turning the valve stem in the clockwise direction.
- Press the TEST RUN button on the indoor unit again, and after 2-3 minutes of operation, turn the valve stem of the 3-way valve quickly in the clockwise direction to close it, then stop the operation.
- Tighten the caps of the 2-way valve and 3-way valve to the stipulated torque.
- Remove the connection pipes (liquid side and gas side).

b. Removing the indoor and outdoor units

- Disconnect the pipes and connecting electric cables from between the indoor and outdoor units.
- Put capped flare nuts onto all of the pipe connections of the indoor and outdoor units, to make sure no dust or other foreign matter enters.
- Remove the indoor and outdoor units.

2. Installing the unit

Install the unit using new refrigerant piping. Follow the instructions in section 4.1 to evacuate the pipes connecting the indoor and outdoor units, and the pipes of the indoor unit, and check for gas leaks.

11.4.3. AC Units Replacement (Using Existing Refrigerant Piping)

When replacing an R410A AC unit with another R410A AC unit, you should re-flare the refrigerant piping. Even though the replacement AC unit uses the R410A, problems occur when, for example, either the AC unit maker or the refrigerating machine oil is different.

When replacing an R22 AC unit with an R410A AC unit, the following checks and cleaning procedures are necessary but are difficult to do because of the chemical characteristics of the refrigerating machine oil (as described in items c) and d) of section **About R410A Refrigerant**). In this case, you should use new refrigerant piping rather than the existing piping.

1. Piping check

Because of the different pressure characteristics of R22 and R410A, the design pressure for the equipment is 1.6 times different. The wall thickness of the piping must comply with that shown in Table 10, but this is not easy to check. Also, even if the thickness is correct, there may be flattened or bent portions midway through the piping due to sharp curves. Buried sections of the piping also cannot be checked.

2. Pipe cleaning

A large quantity of refrigerating machine oil (mineral oil) adheres to existing pipes due to the refrigeration cycle circulation. If the pipes are used just as they are for the R410A cycle, the capacity will be lowered due to the incompatibility of this oil with the R410A, or irregularities may occur in the refrigeration cycle. For this reason, the piping must be thoroughly cleaned, but this is difficult with the present technology.

11.4.4. Refrigerant Compatibility (Using R410A Refrigerant in R22 ACs and Vice Versa)

Do not operate an existing R22 AC with the new R410A refrigerant. Doing so would result in improper functioning of the equipment or malfunction, and might lead to a major accident such as an explosion in the refrigeration cycle. Similarly, do not operate an R410A AC with R22 refrigerant. The chemical reaction between the refrigerating machine oil used in R410A ACs and the chlorine that is contained in R22 would cause the refrigerating machine oil to degrade and lead to malfunction.

11.4.5. Recharging Refrigerant During Servicing

When recharging is necessary, insert the specified amount of new refrigerant in accordance with the following procedure.

1. Connect the charging hose to the service port of the outdoor unit.
2. Connect the charging hose to the vacuum pump adaptor. At this time, fully open the 2-way valve and 3-way valve.

3. Fully open the handle Lo of the manifold gauge, turn on the power of the vacuum pump and continue the vacuum process for at least one hour.
4. Confirm that the low pressure gauge shows a reading of -0.1 Mpa (-76 cmHg), then fully close the handle Lo, and turn off the vacuum pump. Wait for 1-2 minutes, then check to make sure that the needle of the Low pressure gauge has not returned. See Fig. 13 for the remaining steps of this procedure.
5. Set the refrigerant cylinder onto the electronic scale, then connect the hose the cylinder and to the connection port for the electronic scale. (1)(2)

Precaution:

Be sure to set up the cylinder for liquid charging. If you use a cylinder equipped with a siphon tube, you can charge the liquid without having to turn the cylinder around

6. Remove the charging hose of the manifold gauge from the vacuum pump adaptor, and connect it to the connection port of the electronic scale. (2)(3)
7. Open the valve of the refrigerant cylinder, then open the charging valve slightly and close it. Next, press the check valve of the manifold gauge and purge the air. (2)(4) (Watch the liquid refrigerant closely at this point.)
8. After adjusting the electronic scale to zero, open the charging valve, then open the valve Lo of the manifold gauge and charge with the liquid refrigerant. (2)(5) (Be sure to read the operating instructions for the electronic scale.)
9. If you cannot charge the stipulated amount, operate the unit in the cooling mode while charging a little of the liquid at a time (about 150 g/time as a guideline). If the charging amount is insufficient from one operation, wait about one minute, then use the same procedure to do the liquid charging again.

Precaution:

Never use the gas side to allow a larger amount of liquid refrigerant to be charged while operating the unit.

10. Close the charging valve, and after charging the liquid refrigerant inside the charging hose, fully close the valve Lo of the manifold gauge, and stop the operation of the unit. (2)(5)
11. Quickly remove the charging hose from the service port. (6) If you stop midway through, the refrigerant that is in the cycle will be discharged.
12. After putting on the caps for the service port and operating valve, inspect around the caps for a gas leak. (6)(7)

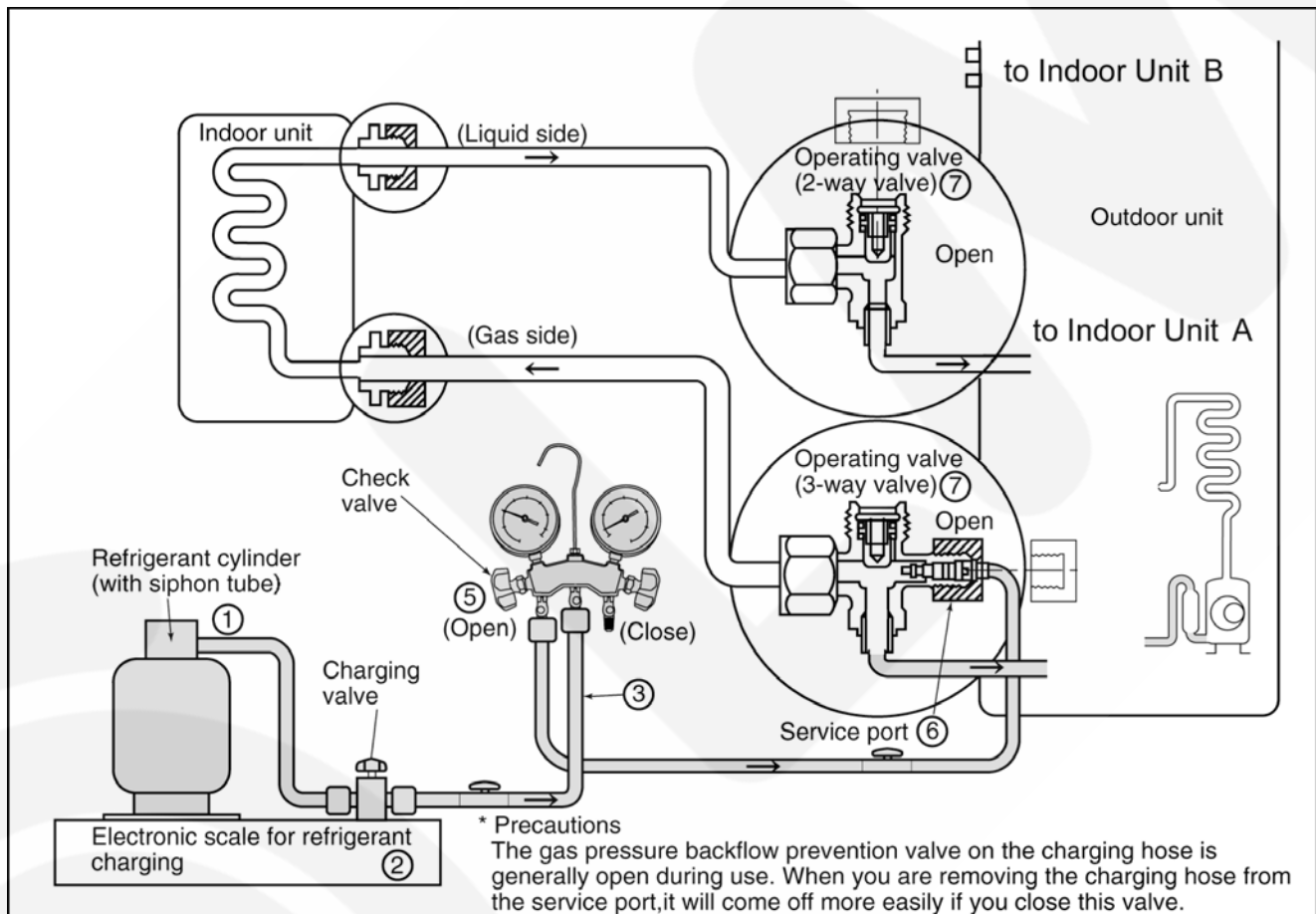

Fig. 13 Re-charging refrigerant

11.4.6. Brazing

As brazing requires sophisticated techniques and experiences, it must be performed by a qualified person. In order to prevent the oxide film from occurring in the pipe interior during brazing, it is effective to proceed with brazing while letting dry nitrogen gas (N₂) flow.

<Brazing Method for Preventing Oxidation>

1. Attach a reducing valve to the nitrogen gas cylinder.
2. Apply a seal onto the clearance between the piping and inserted pipe for the nitrogen gas in order to prevent the nitrogen gas from flowing backward.
3. When the nitrogen gas is flowing, be sure to keep the piping end open.
4. Adjust the flow rate of nitrogen gas so that it is lower than 0.05 m³/h, or 0.02 MPa (0.2 kgf/cm²) by means of the reducing valve.
5. After taking the steps above, keep the nitrogen gas flowing until the piping cools down to a certain extent (i.e. temperature at which pipes are touchable with finger).
6. Completely remove the flux after brazing.

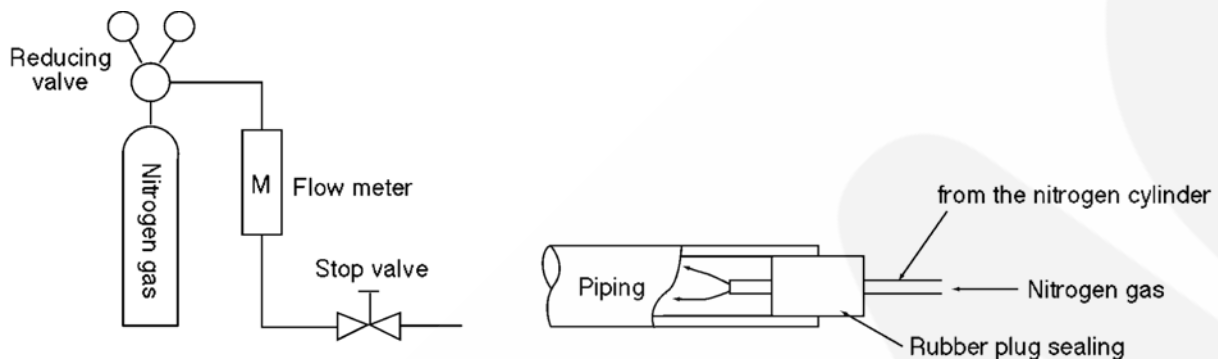

Fig. 14 Prevention of Oxidation during Brazing

Cautions during brazing

1. General Cautions

- a. The brazing strength should be high as required.
- b. After operation, airtightness should be kept under pressurized condition.
- c. During brazing do not allow component materials to become damaged due to overheating.
- d. The refrigerant pipe work should not become blocked with scale or flux.
- e. The brazed part should not restrict the flow in the refrigerant circuit.
- f. No corrosion should occur from the brazed part.

2. Prevention of Overheating

Due to heating, the interior and exterior surfaces of treated metal may oxidize. Especially, when the interior of the refrigerant circuit oxidizes due to overheating, scale occurs and stays in the circuit as dust, thus exerting a fatally adverse effect. So, make brazing at adequate brazing temperature and with minimum of heating area.

3. Overheating Protection

In order to prevent components near the brazed part from overheating damage or quality deterioration due to flame or heat, take adequate steps for protection such as (1) by shielding with a metal plate, (2) by using a wet cloth, and (3) by means of heat absorbent.

4. Movement during Brazing

Eliminate all vibration during brazing to protect brazed joints from cracking and breakage.

5. Oxidation Preventative

In order to improve the brazing efficiency, various types of antioxidant are available on the market. However, the constituents of these are widely varied, and some are anticipated to corrode the piping materials, or adversely affect HFC refrigerant, lubricating oil, etc. Exercise care when using an oxidation preventative.

11.4.7. Servicing Tips

The drier must also be replaced whenever replacing the refrigerant cycle parts. Replacing the refrigerant cycle parts first before replacing the drier. The drier is supplied in a vacuum pack. Perform brazing immediately after opening the vacuum pack, and then start the vacuum within two hours. In addition, the drier also needs to be replaced when the refrigerant has leaked completely. (Applicable for drier model only.)

12 Servicing Information

Caution:

- Pb free solder has a higher melting point than standard solder; Typically the melting point is 50 - 70°F (30 - 40°C) higher. Please use a high temperature soldering iron. In case of the soldering iron with temperature control, please set it to 700 ± 20°F (370 ± 10°C).
- Pb free solder will tend to splash when heated too high (about 1100° F/600°C).

12.1. Troubleshooting

1. Rated Frequency Operation

During troubleshooting and servicing, rated compressor operating frequency must be obtained in order to check the specification and technical data. Below are the methods used to obtain rated compressor operating specification.

(a) Cooling

- Press the Auto button continuously for 5 seconds or less than 8 seconds, the air conditioner starts operation at Cooling rated frequency. ("beep" will be heard at the 5th second.)

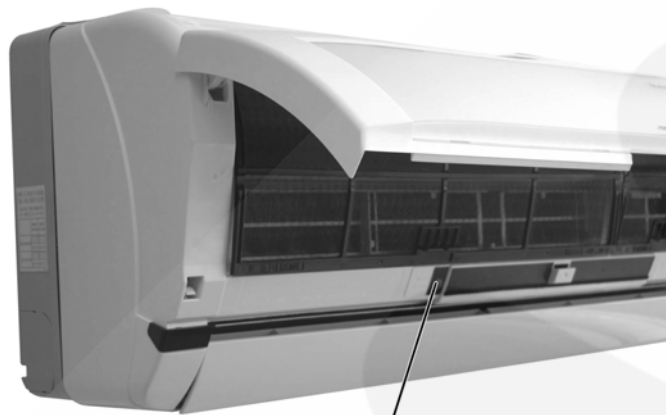

Automatic Operation Switch

- Short the service terminal (CN-S) of the outdoor printed circuit board. The operation of air conditioner is Cooling rated frequency.

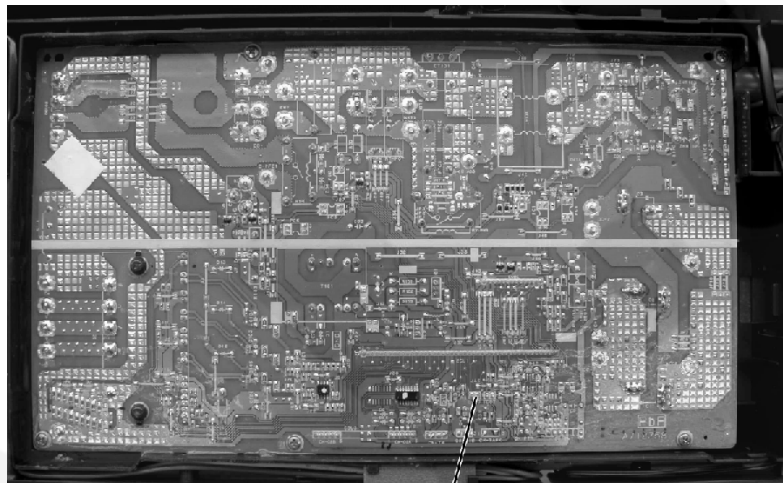

CN-S

(b) Heating

Press the Auto button continuously for 8 seconds or less than 11 seconds, the air conditioner starts operation at Heating rated frequency. ("beep" "beep" will be heard at the 8th second.)

2. Troubleshooting Air Conditioner

Refrigeration cycle system

In order to diagnose malfunctions, make sure that there are no electrical problems before inspecting the refrigeration cycle. Such problems include insufficient insulation, problem with the power source, malfunction of a compressor and a fan.

The normal outlet air temperature and pressure of the refrigeration cycle depends on various conditions, the standard values for them are shown in the table to the right.

Normal Pressure and Outlet Air Temperature (Standard)

	Gas pressure MPa (kg/cm ² G)	Outlet air temperature (°C)
Cooling Mode	0.9 ~ 1.2 (9 ~ 12)	12 ~ 16
Heating Mode	2.3 ~ 2.9 (23 ~ 29)	36 ~ 45

- ★ Condition:
- Indoor fan speed; High
 - Outdoor temperature 35°C at cooling mode and 7°C at heating mode.
 - Compressor operates at rated frequency

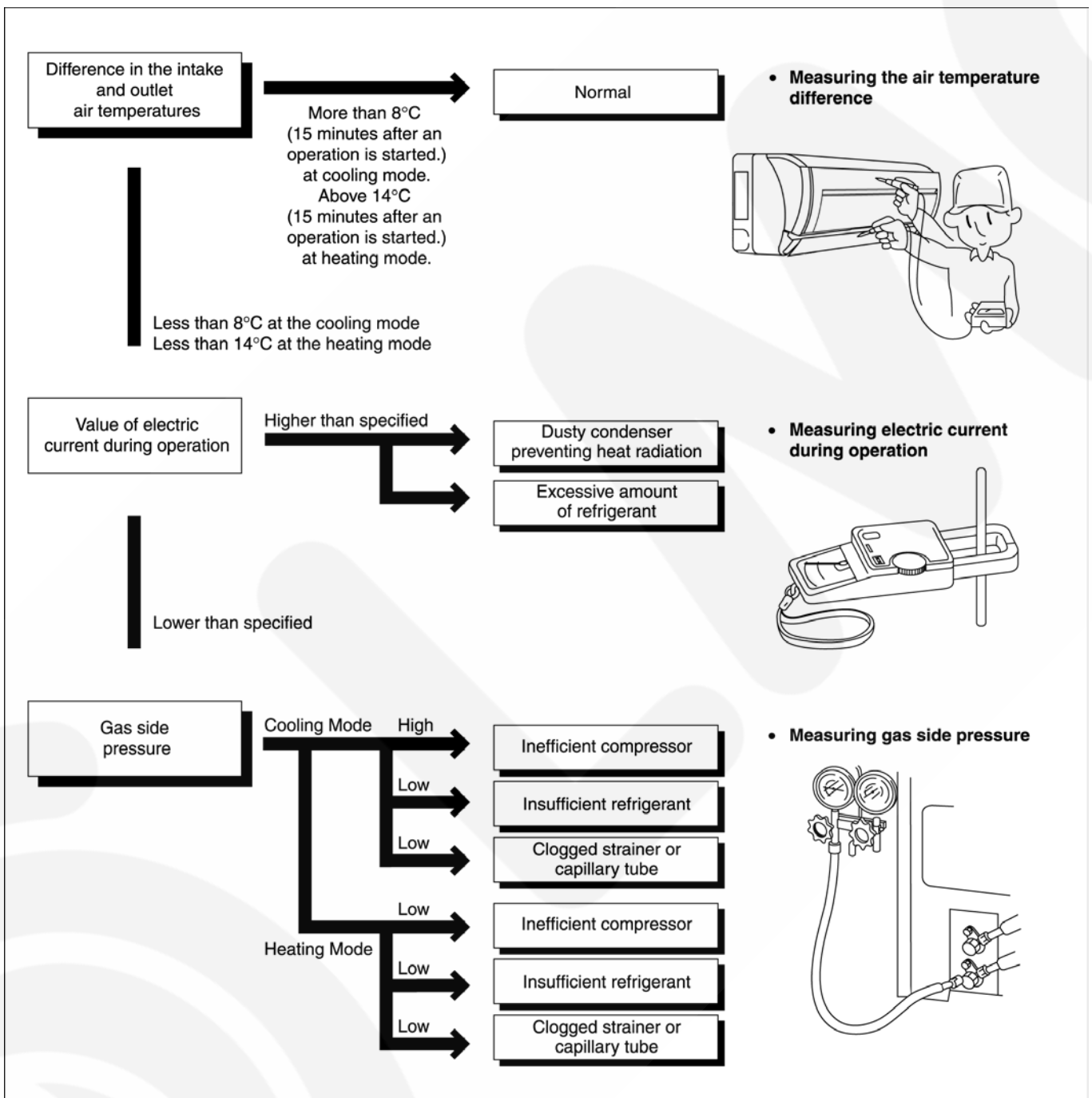

1. Relationship between the condition of the air conditioner and pressure and electric current

Condition of the air conditioner	Cooling Mode			Heating Mode		
	Low Pressure	High Pressure	Electric current during operation	Low Pressure	High Pressure	Electric current during operation
Insufficient refrigerant (gas leakage)	↘	↘	↘	↘	↘	↘
Clogged capillary tube or Strainer	↘	↘	↘	↗	↗	↗
Short circuit in the indoor unit	↘	↘	↘	↗	↗	↗
Heat radiation deficiency of the outdoor unit	↗	↗	↗	↘	↘	↘
Inefficient compression	↗	↘	↘	↗	↘	↘

- Carry on the measurements of pressure, electric current, and temperature fifteen minutes after an operation is started.

12.2. Breakdown Self Diagnosis Function

Once abnormality detected during operation, the unit will immediately stop its operation (Timer LED is blinking) and maximum of three error codes (abnormality) will be saved in memory. The abnormality of the operation can be identified through the below breakdown diagnosis method:

- Press "CHECK" button at remote controller continuously for more than five seconds to turn on the diagnosis mode, "H11" will be displayed at remote controller.
- By pressing the TMER "Λ" button once, next error code will be displayed; press "V" button once, previous error code will be displayed.
- If error code displayed matches the error code saved in unit memory (abnormality detected), four "beep" sounds will be heard and Power LED will light on. Otherwise, one "beep" sound is heard.

If "CHECK" button is press again or without any operation for 30 seconds, the diagnosis mode will turn off.

Error Codes Table

Diagnosis display	Abnormality / Protection control	Abnormality Judgement	Emergency operation	Primary location to verify
H11	Indoor / outdoor abnormal communication	> 1 min after starting operation	Indoor fan operation only	<ul style="list-style-type: none"> • Internal / external cable connections • Indoor / Outdoor PCB
H14	Indoor intake air temperature sensor abnormality	—	—	<ul style="list-style-type: none"> • Intake air temperature sensor (defective or disconnected)
H15	Outdoor compressor temperature sensor abnormality	Continue for 5 sec.	—	<ul style="list-style-type: none"> • Compressor temperature sensor (defective or disconnected)
H16	Outdoor Current Transformer open circuit	—	—	<ul style="list-style-type: none"> • Outdoor PCB • IPM (Power transistor) module
H19	Indoor fan motor mechanism lock	—	—	<ul style="list-style-type: none"> • Indoor PCB • Fan motor
H23	Indoor heat exchanger temperature sensor abnormality	Continue for 5 sec.	O (Cooling only)	<ul style="list-style-type: none"> • Heat exchanger temperature sensor (defective or disconnected)
H26	Ionizer abnormality	—	—	<ul style="list-style-type: none"> • Indoor PCB • Ionizer
H27	Outdoor air temperature sensor abnormality	Continue for 5 sec.	O	<ul style="list-style-type: none"> • Outdoor temperature sensor (defective or disconnected)
H28	Outdoor heat exchanger temperature sensor abnormality	Continue for 5 sec.	O	<ul style="list-style-type: none"> • Outdoor heat exchanger temperature sensor (defective or disconnected)
H33	Indoor/Outdoor wrong connection	—	—	<ul style="list-style-type: none"> • Indoor/Outdoor supply voltage
H97	Outdoor Fan Motor lock abnormality	—	—	<ul style="list-style-type: none"> • Outdoor PCB • Outdoor Fan Motor
H98	Indoor high pressure protection	—	—	<ul style="list-style-type: none"> • Air filter dirty • Air circulation short circuit
H99	Indoor heat exchanger anti-freezing protection	—	—	<ul style="list-style-type: none"> • Insufficient refrigerant • Air filter dirty
F11	Cooling / Heating cycle changeover abnormality	4 times occurrence within 30 minutes	—	<ul style="list-style-type: none"> • 4-way valve • V-coil
F91	Refrigeration cycle abnormality	2 times occurrence within 20 minutes	—	<ul style="list-style-type: none"> • No refrigerant (3-way valve is closed)
F93	Outdoor compressor abnormal revolution	4 times occurrence within 20 minutes	—	<ul style="list-style-type: none"> • Outdoor compressor
F95	Cool high pressure protection	4 times occurrence within 20 minutes	—	<ul style="list-style-type: none"> • Outdoor refrigerant circuit
F96	IPM (power transistor) overheating protection	—	—	<ul style="list-style-type: none"> • Excess refrigerant • Improper heat radiation • IPM (Power transistor)
F97	Outdoor compressor overheating protection	4 times occurrence within 10 minutes	—	<ul style="list-style-type: none"> • Insufficient refrigerant • Compressor
F98	Total running current protection	3 times occurrence within 20 minutes	—	<ul style="list-style-type: none"> • Excess refrigerant • Improper heat radiation
F99	Outdoor Direct Current (DC) peak detection	7 times occurrence continuously	—	<ul style="list-style-type: none"> • Outdoor PCB • IPM (Power transistor) • Compressor

Note:

“O” - Frequency measured and fan speed fixed.

The memory data of error code is erased when the power supply is cut off, or press the Auto Switch until “beep” sound heard following by pressing the “RESET” button at remote controller.

Although operation forced to stop when abnormality detected, emergency operation is possible for certain errors (refer to Error Codes Table) by using remote controller or Auto Switch at indoor unit. However, the remote controller signal receiving sound is changed from one “beep” to four “beep” sounds.

12.3. Remote Control

• Remote Control Reset

When the batteries are inserted for the first time, or the batteries are replaced, all the indications will blink and the remote control might not work.

If this happen, remove the cover of the remote control and push the reset point once to clear the memory data.

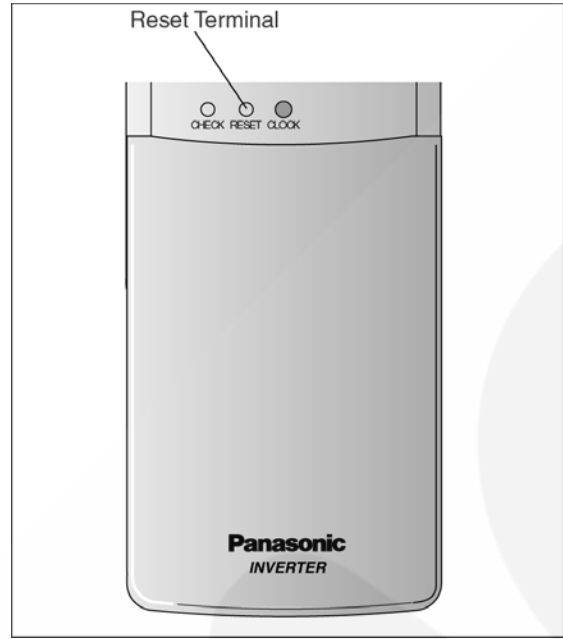

• Changing the wireless remote control transmission code

When there are more than one indoor units installed in the same room, it is possible to set different remote control receiving signal by modifying the jumpers inside remote controller.

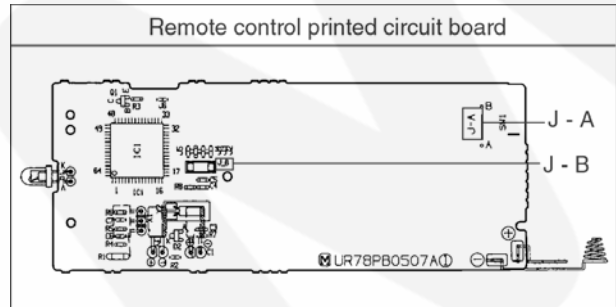

	Remote control printed circuit board		Note
	J - A	J - B	
0	SHORT	OPEN	At product delivery
1	OPEN	OPEN	
2	SHORT	SHORT	
3	OPEN	SHORT	

12.4. Disassembly Of Parts

12.4.1. Indoor Control Board Removal Procedures

1. Remove the Front Grille

- ② Remove the Front Grille by releasing the 2 hooks at the top of the Front Grille



- ① Remove the 2 caps and 2 screws at the bottom of the Front Grille

Fig. 1



- ③ Remove the Front Grille

Fig. 2

2. Remove the Indoor Control Board

- ③ Remove the Control Board cover



- ② Remove Earth Wire screw
- ① Remove screws

Fig.3

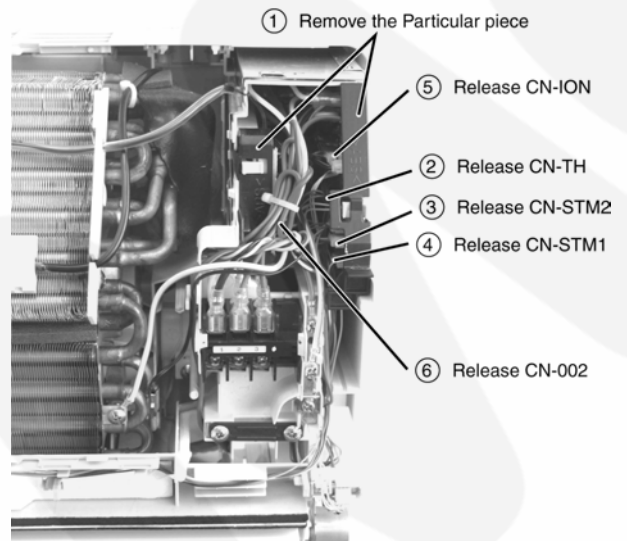

- ① Remove the Particular piece
- ⑤ Release CN-ION
- ② Release CN-TH
- ③ Release CN-STM2
- ④ Release CN-STM1
- ⑥ Release CN-002

Fig. 4

- ① Push up the tab to remove the Indicator Complete



- ② Release the connecting wire
- ④ Pull it downward to remove the Discharge Grille
- ③ Pull out the Drain Hose
- ⑤ Release the Connector ION

Fig. 5

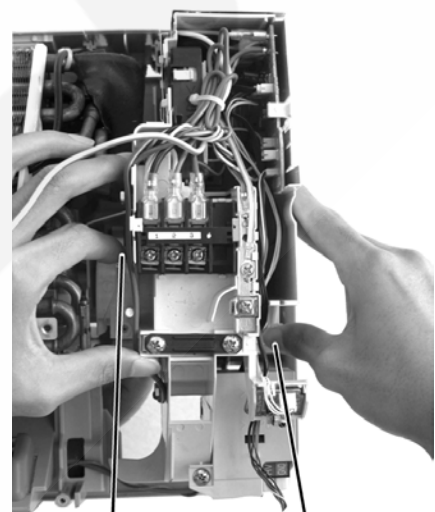

- Press down
- Pull up

Fig. 6

12.4.2. Indoor Electronic Controller Removal Procedures

1. Remove Main Electronic Controller

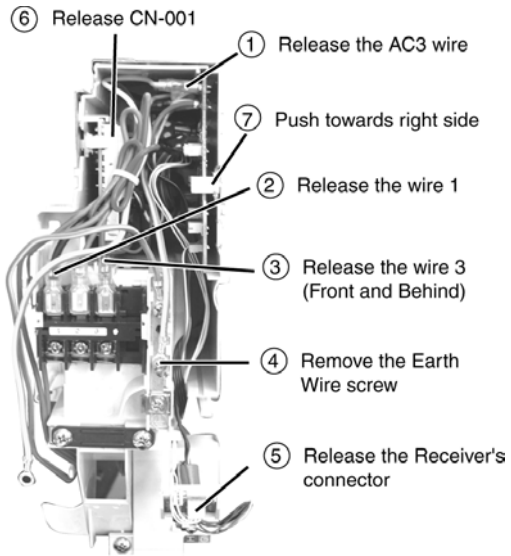

Fig. 7

2. Remove Power Electronic Controller

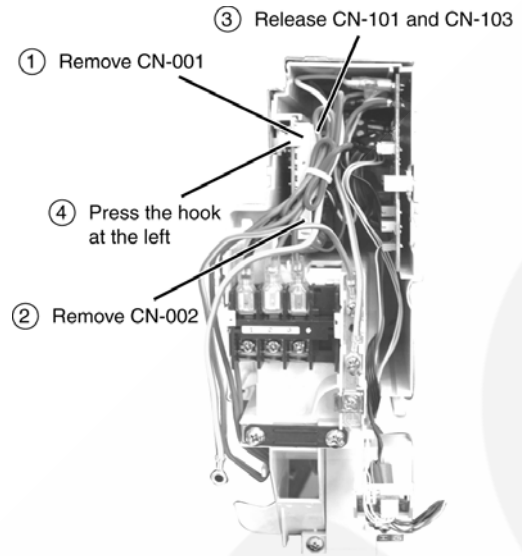
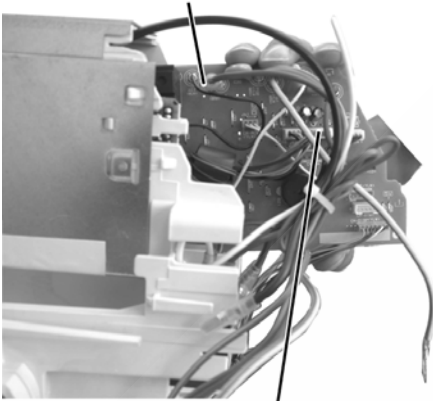

Fig. 10

- ① Pull the Electronic Controller partially out until you are able to remove the wire



- ② Release CN-MAIN

Fig. 8

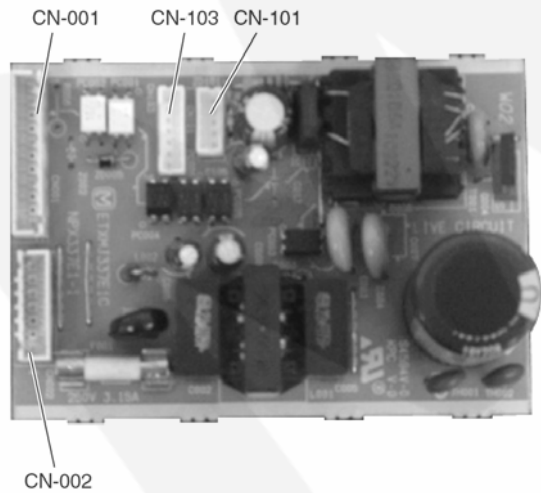

Fig. 11

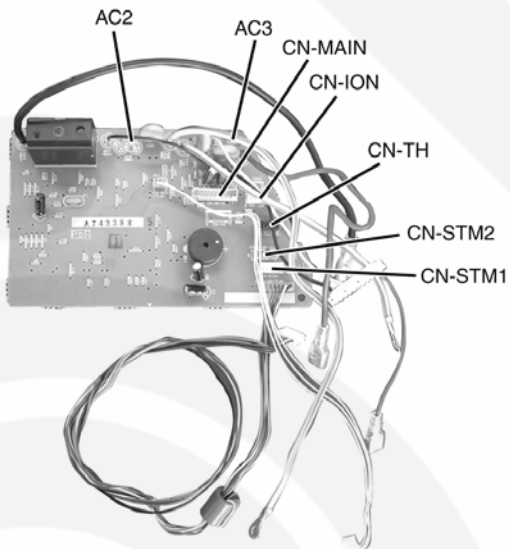
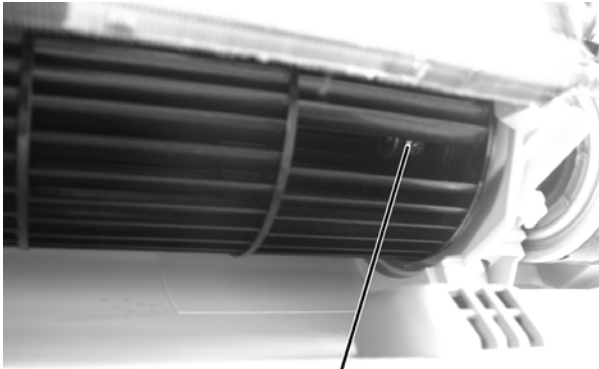

Fig. 9

12.4.3. Cross Flow Fan and Indoor Fan Motor Removal Procedures

1. Remove Cross Flow Fan



Remove the screw that holding the Fan Motor and Cross Flow Fan

Fig. 12

2. Remove the Fan Motor

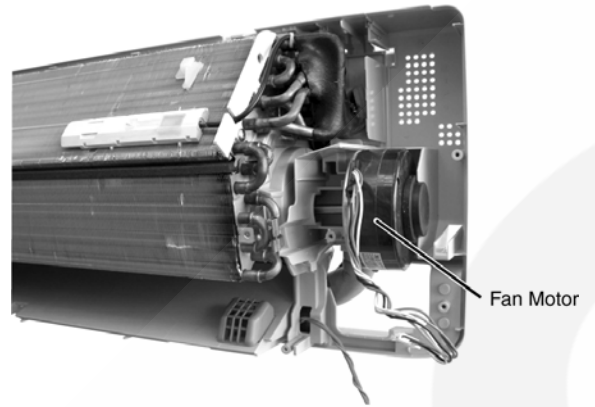

Fig. 15

① Remove the screws



② Remove the Bushing

Fig. 13

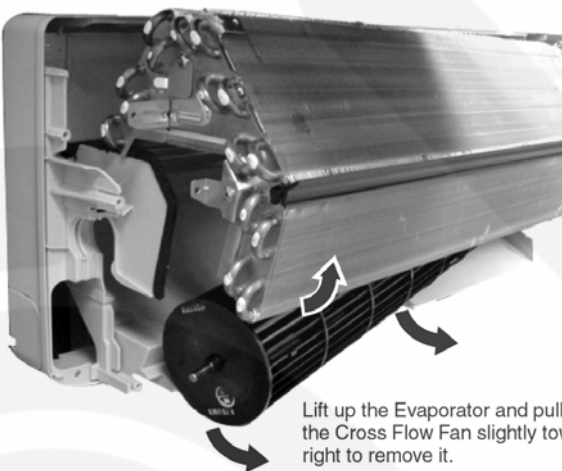

Lift up the Evaporator and pull out the Cross Flow Fan slightly towards right to remove it.

Fig. 14

12.4.4. Outdoor Electronic Controller Removal Procedures

1. Remove the top panel and front panel

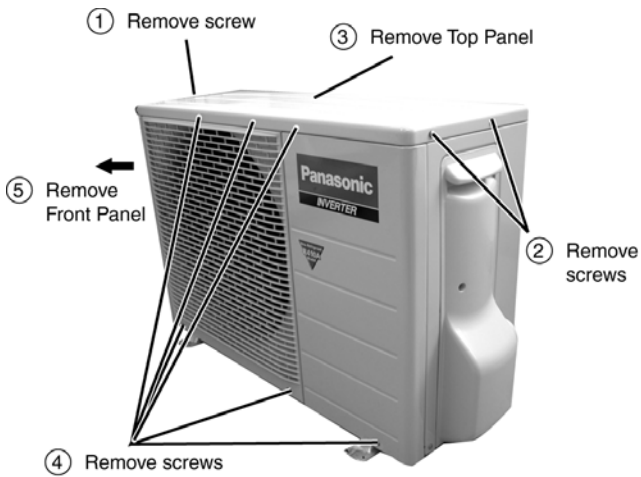

Fig. 16

CAUTION
 • Due to high voltage, do not touch the terminals in the hatching area during operation and during one minute after switching OFF.

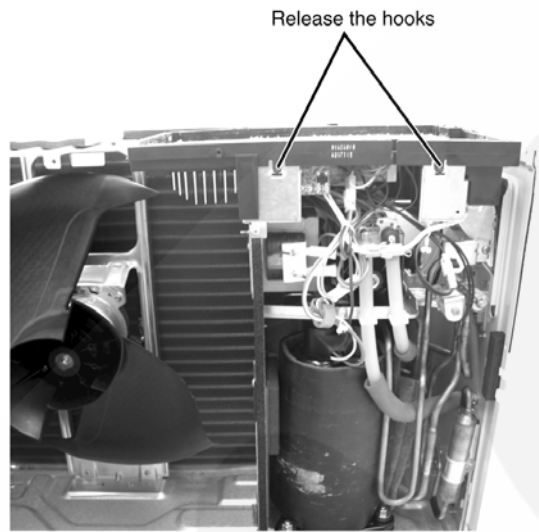

Fig. 17

2. Remove the Outdoor Electronic Controller

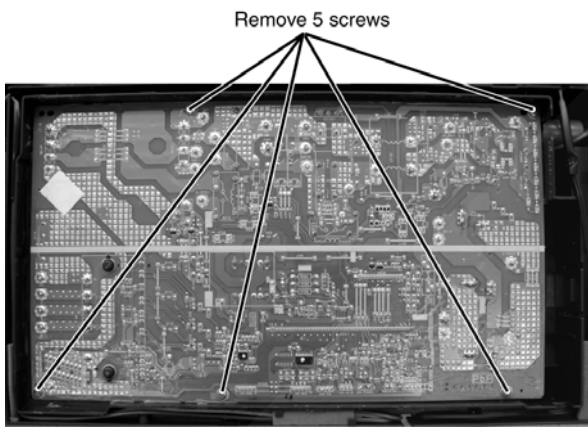
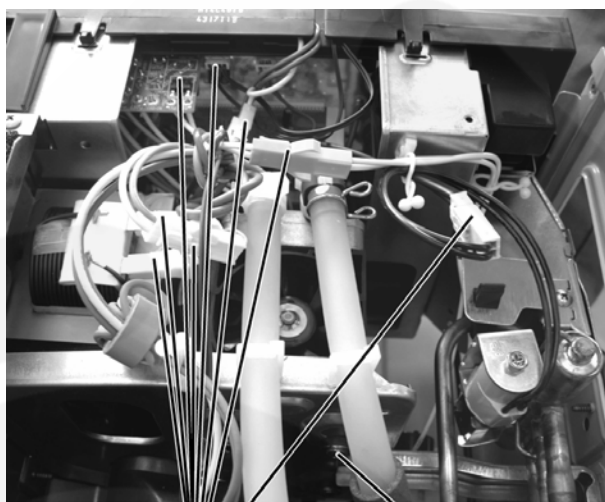

Fig. 18

Caution! When handling electronic controller, be careful of electrostatic discharge.



① Remove the screw then release the 3 connectors inside
 ② Remove 8 connectors

Fig. 19

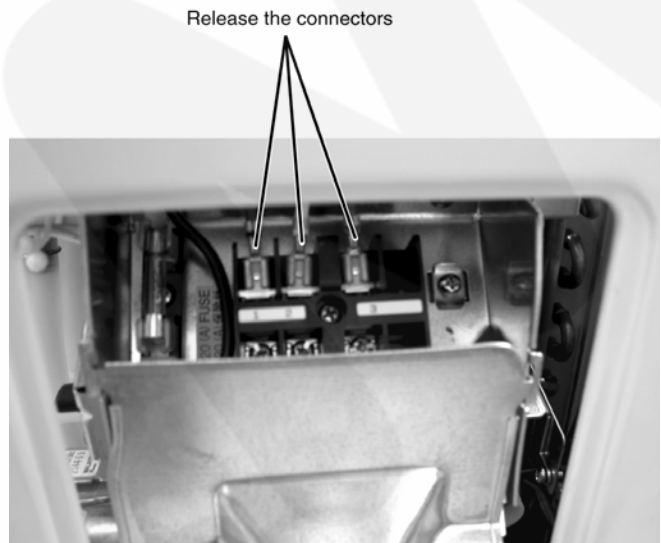

Fig.20

13 Technical Data

■ Operation characteristics

CS-XE9DKE CU-XE9DKE

• Cooling Characteristic

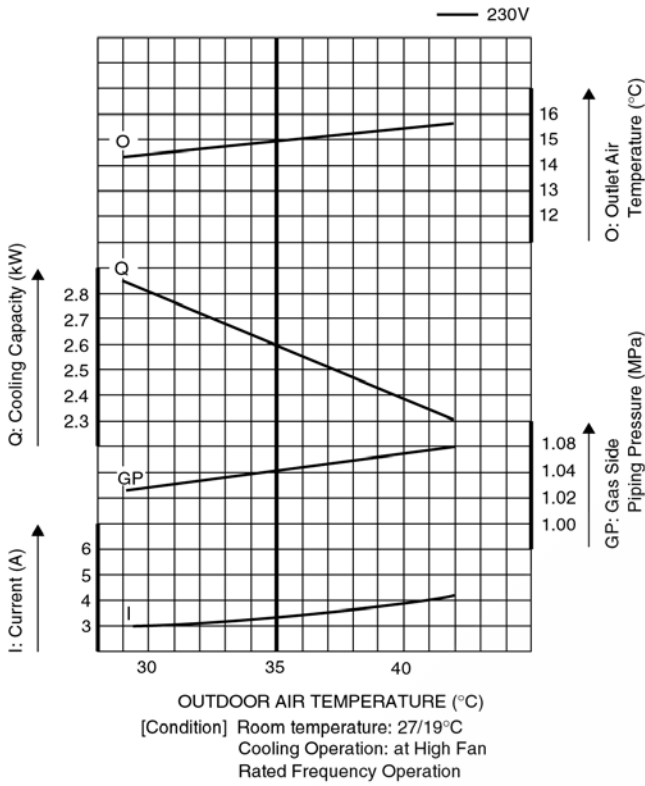

• Piping Length Characteristic (Cooling)

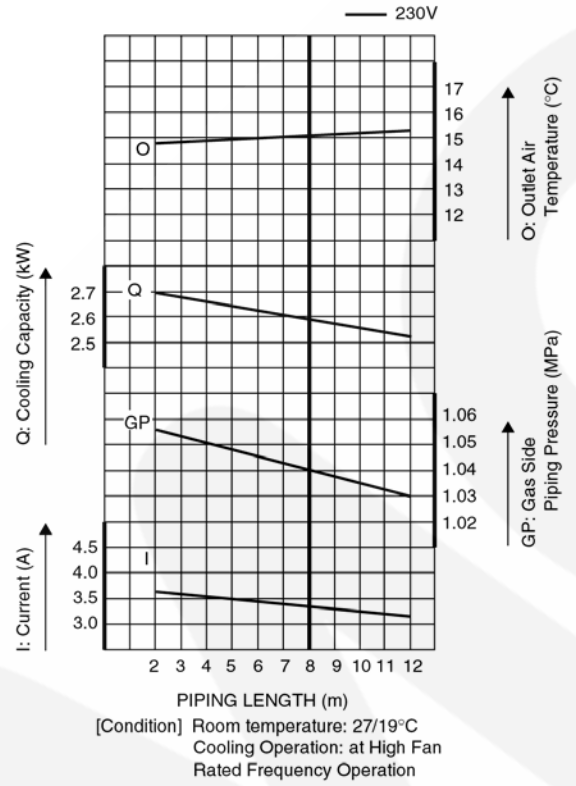

• Heating Characteristic

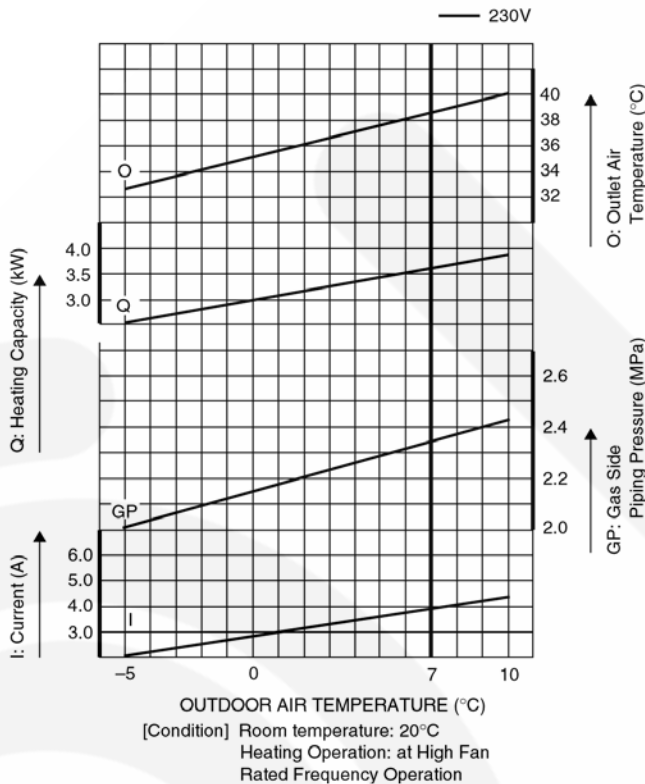

• Piping Length Characteristic (Heating)

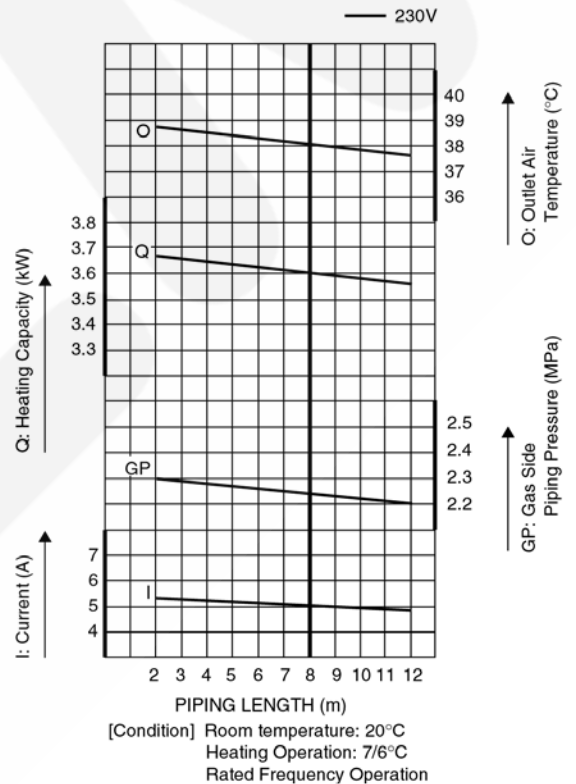

■ Operation characteristics

CS-XE12DKE CU-XE12DKE

● Cooling Characteristic

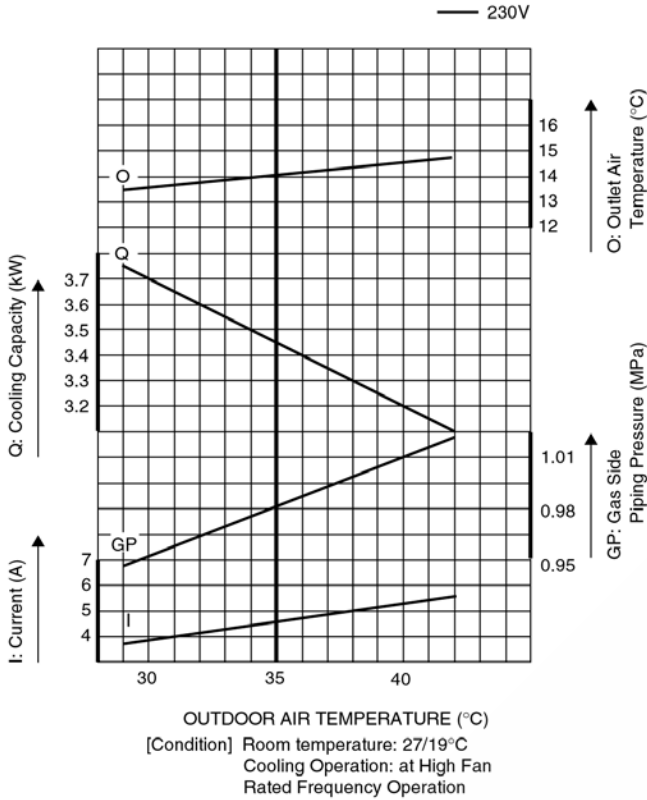

● Piping Length Characteristic (Cooling)

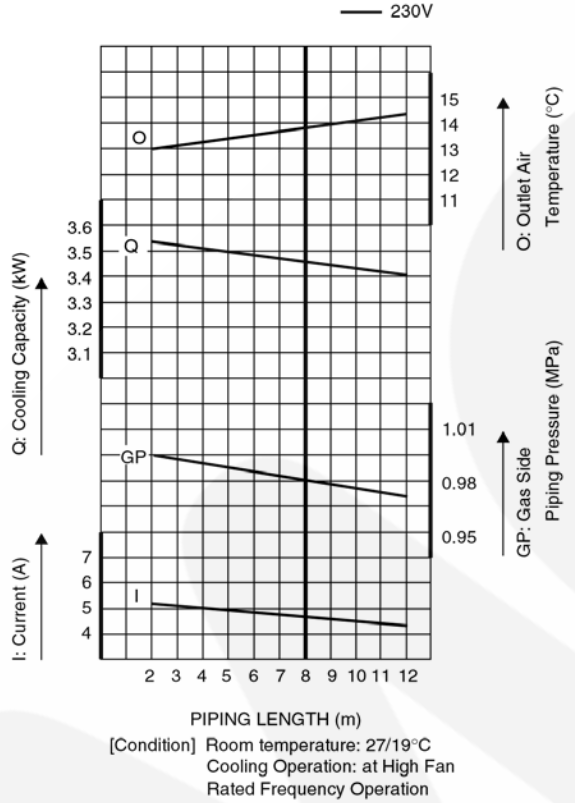

● Heating Characteristic

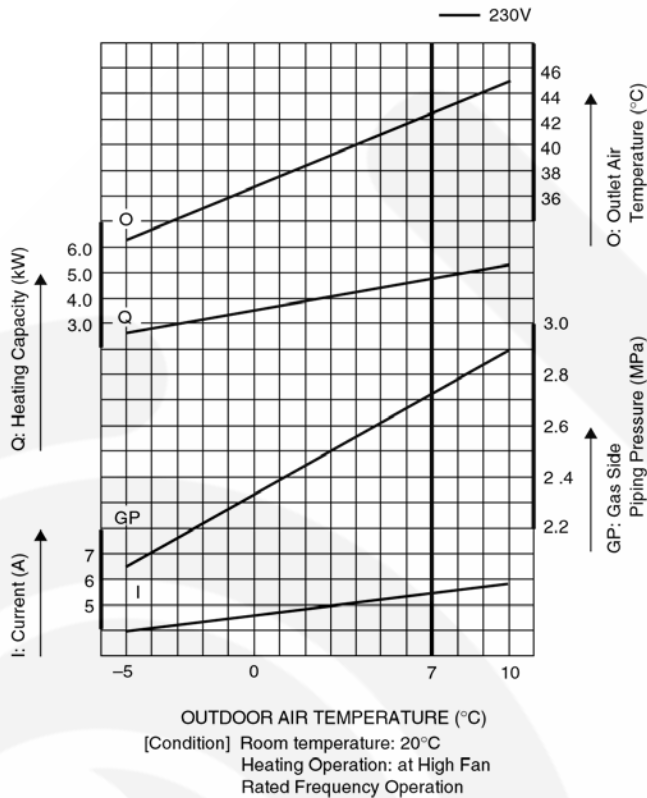

● Piping Length Characteristic (Heating)

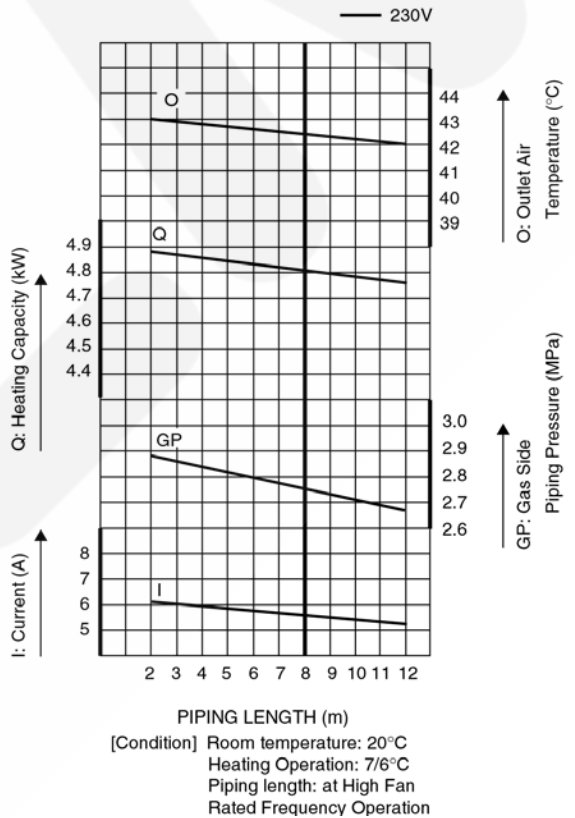

■ Sensible Capacity Chart

● CS-XE9DKE CU-XE9DKE

230V Indoor wet bulb temp.	Outdoor Temp. (°C)											
	30			35			40			46		
	TC	SHC	IP	TC	SHC	IP	TC	SHC	IP	TC	SHC	IP
17.0°C	2.58	1.96	0.64	2.41	1.88	0.69	2.24	1.80	0.74	2.04	1.71	0.80
19.0°C				2.60		0.70						
19.5°C	2.83	2.05	0.65	2.65	1.97	0.70	2.46	1.89	0.75	2.24	1.80	0.81
22.0°C	3.09	2.12	0.67	2.88	2.04	0.72	2.68	1.97	0.77	2.44	1.88	0.83

● CS-XE12DKE CU-XE12DKE

230V Indoor wet bulb temp.	Outdoor Temp. (°C)											
	30			35			40			46		
	TC	SHC	IP	TC	SHC	IP	TC	SHC	IP	TC	SHC	IP
17.0°C	3.42	2.59	0.87	3.20	2.49	0.94	2.97	2.39	1.00	2.70	2.27	1.08
19.0°C				3.45		0.95						
19.5°C	3.76	2.72	0.89	3.51	2.61	0.95	3.27	2.51	1.02	2.97	2.39	1.10
22.0°C	4.10	2.82	0.90	3.83	2.71	0.97	3.56	2.61	1.04	3.24	2.49	1.12

14 Exploded View (Indoor Unit)

14.1. CS-XE9DKE CS-XE12DKE

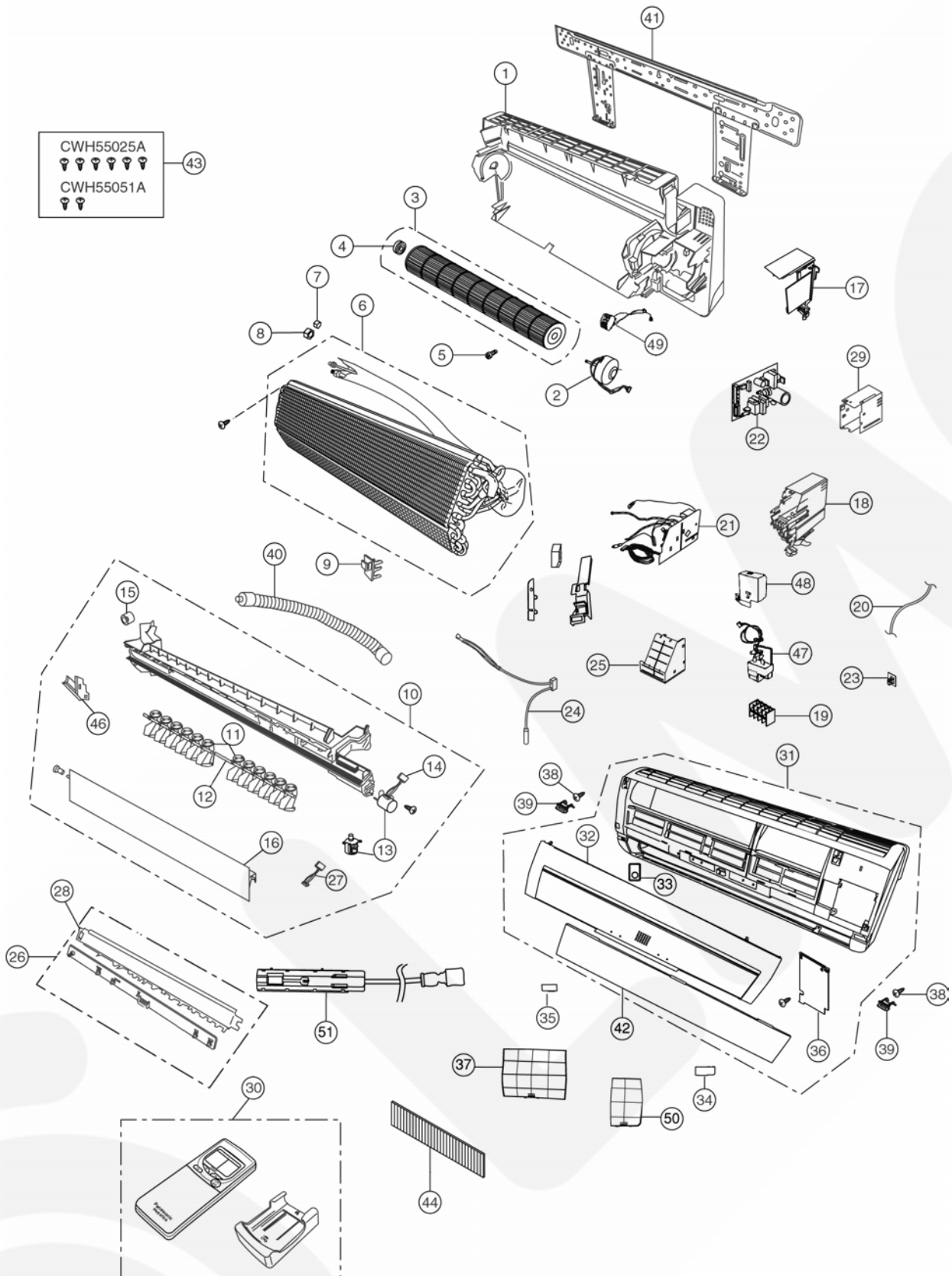

Note:

The above exploded view is for the purpose of parts disassembly and replacement.

The non-numbered parts are not kept as standard service parts.

15 Replacement Parts List (Indoor Unit)

15.1. CS-XE9DKE CS-XE12DKE

REF. NO.	PART NAME & DESCRIPTION	QTY.	CS - XE9DKE	CS - XE12DKE	REMARKS
1	CHASSY COMPLETE	1	CWD50C1435	←	
2	FAN MOTOR	1	CWA981056	←	0
3	CROSS FLOW FAN COMPLETE	1	CWH02C1028	←	
4	BEARING ASS'Y	1	CWH64K007	←	
5	SCREW - CROSS FLOW FAN	1	CWH4580304	←	
6	EVAPORATOR	1	CWB30C1439	CWB30C1438	
7	FLARE NUT	1	CWT25086 (1/4")	←	
8	FLARE NUT	1	CWT251031 (3/8")	CWT251032 (1/2")	
9	INTAKE AIR SENSOR HOLDER	1	CWH32142	←	
10	DISCHARGE GRILLE COMPLETE	1	CWE20C2448	←	
11	VERTICAL VANE	12	CWE241088	←	
12	CONNECTING BAR	1	CWE261035	←	
13	AIR SWING MOTOR	2	CWA98260	←	0
14	LEAD WIRE - AIR SWING MOTOR	1	CWA67C3977	←	
15	CAP - DRAIN TRAY	1	CWH52C1001	←	
16	HORIZONTAL VANE	1	CWE241070A	←	
17	BACK COVER CHASSIS	1	CWD932162	←	
18	CONTROL BOARD CASING	1	CWH102103	←	
19	TERMINAL BOARD COMPLETE	1	CWA28C2128	←	0
20	POWER SUPPLY CORD	1	CWA20C2208	←	
21	ELECTRONIC CONTROLLER - MAIN	1	CWA73C1594	CWA73C1595	0
22	ELECTRONIC CONTROLLER - P. SUPPLY	1	CWA743304	←	0
23	ELECTRONIC CONTROLLER - RECEIVER	1	CWA742724	←	0
24	SENSOR COMPLETE	1	CWA50C2122	←	0
25	CONTROL BOARD FRONT COVER	1	CWH131090	←	
26	ELECTRONIC CONTROLLER - INDICATOR	1	CWE39C1107	←	0
27	LEAD WIRE - AIR SWING MOTOR	1	CWA67C3849	←	
28	INDICATOR HOLDER	1	CWD932338	←	
29	CONTROL BOARD TOP COVER	1	CWH131091	←	
30	REMOTE CONTROL COMPLETE	1	CWA75C2428	←	0
31	FRONT GRILLE COMPLETE	1	CWE11C3239	←	0
32	INTAKE GRILLE	1	CWE22C1187	←	
33	CONTROL PANEL	1	CWE312421	←	
34	DECORATION BASE (R)	1	CWE351075	←	
35	DECORATION BASE (L)	1	CWE351076	←	
36	GRILLE DOOR	1	CWE141064	←	
37	AIR FILTER	1	CWD001053	←	
38	SCREW - FRONT GRILLE	2	XTN4+16C	←	
39	CAP - FRONT GRILLE	2	CWH521062A	←	
40	DRAIN HOSE	1	CWH851044	←	
41	INSTALLATION PLATE	1	CWH36K1018	←	
42	FRONT PANEL ASS'Y	1	CWE13K1005	←	
43	BAG COMPLETE - INSTALLATION SCREW	1	CWH82C067	←	
44	SUPER ALLERU-BUSTER FILTER	1	CWD00C1132	←	0
46	FULCRUM	1	CWH621013	←	
47	ELECTRONIC CONTROLLER - IONIZER	1	CWA743099	←	0
48	CASING - IONIZER	1	CWD932228	←	
49	ION GENERATOR	1	CWH94C0001	←	
50	AIR FILTER	1	CWD001054	←	
51	BOX SHAPED PIECE COMPLETE	1	CWD76C1027	←	

(Note)

- All parts are supplied from PHAAM, Malaysia (Vendor Code: 061).
- "O" marked parts are recommended to be kept in stock.

16 Exploded View (Outdoor Unit)

16.1. CU-XE9DKE CU-XE12DKE

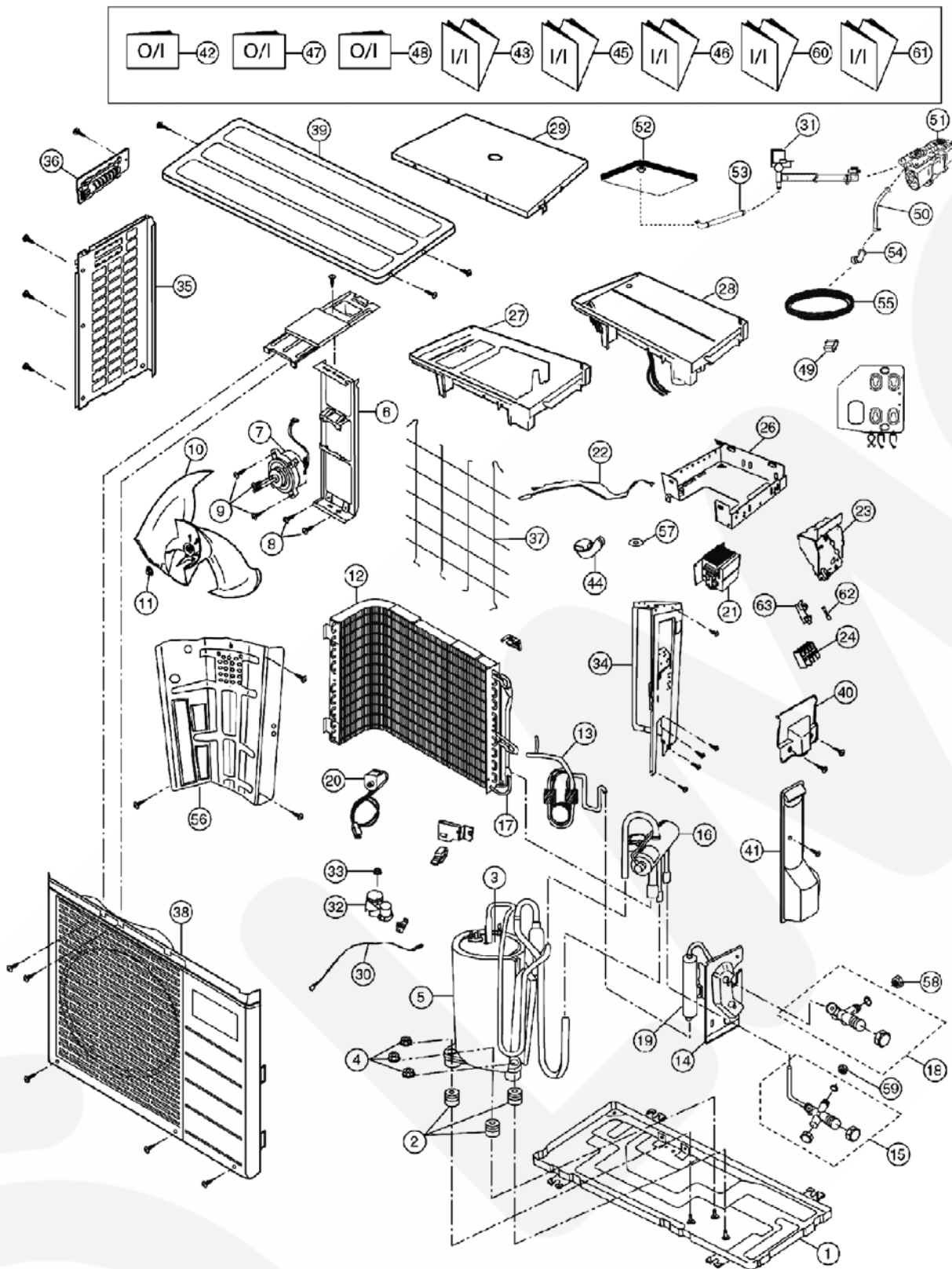

Note:
 The above exploded view is for the purpose of parts disassembly and replacement.
 The non-numbered parts are not kept as standard service parts.

17 Replacement Parts List (Outdoor Unit)

17.1. CU-XE9DKE CU-XE12DKE

REF NO.	DESCRIPTION & NAME	QTY.	CU-XE9DKE	CU-XE12DKE	REMARKS
1	CHASSY ASSY	1	CWD50K2073	←	
2	ANTI-VIBRATION BUSHING	3	CWH50077	←	
3	COMPRESSOR	1	5CS102XEC	←	O
4	NUT-COMPRESSOR MOUNT	3	CWH56000	←	
5	SOUND PROOF MATERIAL	1	CWG302242	←	
6	FAN MOTOR BRACKET	1	CWD541030	←	
7	FAN MOTOR	1	CWA951321	CWA951309	O
8	SCREW - FAN MOTOR BRACKET	2	CWH551060	←	
9	SCREW - FAN MOTOR MOUNT	4	CWH55406	←	
10	PROPELLER FAN ASSY	1	CWH03K1006	←	
11	NUT - PROPELLER FAN	1	CWH56053	←	
12	CONDENSER	1	CWB32C1661	CWB32C1599	
13	TUBE ASS'Y (CAPILLARY TUBE)	1	CWT01C3123	CWT01C3122	
14	HOLDER-COUPLING	1	CWH351023	←	
15	3 WAYS VALVE (GAS)	1	CWB011353	CWB011332	O
16	4 WAYS VALVE	1	CWB001011	←	
17	TUBE ASS'Y (STRAINER)	1	CWT023220	←	
18	2 WAYS VALVE (LIQUID)	1	CWB021285	←	O
19	DRYER	1	CWB101017	←	O
20	V-COIL COMPLETE	1	CWA43C2072	←	
21	REACTOR	1	CWA421050	-	
22	SENSOR COMPLETE	1	CWA50C2115	←	
23	CONTROL BOARD CASING (SIDE)	1	CWH102122	←	
24	TERMINAL BOARD ASSY	1	CWA28K1036	←	
26	CONTROL BOARD CASING (BOTTOM)	1	CWH102114	←	
27	CONTROL BOARD CASING (TOP)	1	CWH102115	←	
28	ELECTRONIC CONTROLLER - MAIN	1	CWA73C1596R	CWA73C1597R	O
29	CONTROL BOARD COVER (TOP)	1	CWH131104	←	
30	SENSOR COMPLETE	1	CWA50C2066	←	
31	2-WAY VALVE COMPLETE (OXYGEN PUMP)	1	CWB02C1008	←	O
32	TERMINAL COVER	1	CWH171001	←	
33	NUT-TERMINAL COVER	1	CWH7080300	←	
34	CABINET SIDE PLATE CO.	1	CWE04C1036	←	
35	CABINET SIDE PLATE (LEFT)	1	CWE041031A	←	
36	HANDLE	1	CWE161010	←	
37	WIRE NET	1	CWD041053A	CWD041054A	
38	CABINET FRONT PLATE CO.	1	CWE06C1039	←	
39	CABINET TOP PLATE	1	CWE031014A	←	
40	CONTROL BOARD COVER	1	CWH131110	←	
41	CONTROL BOARD COVER CO.	1	CWH13C1064	←	
42	OPERATING INSTRUCTION (ENG., FRA., NED. & DEU.)	1	CWF564740	←	
43	INSTALLATION INSTRUCTION (ENG., FRA., ESP. & DEU.)	1	CWF612771	←	
44	L-TUBE	1	CWH5850080	←	
45	INSTALLATION INSTRUCTION (ITA., NED., POR. & GRE.)	1	CWF612772	←	
46	INSTALLATION INSTRUCTION (RUS.)	1	CWF612773	←	
47	OPERATION INSTRUCTION (ENG., ITA., POR. & ESP.)	1	CWF564741	←	
48	OPERATION INSTRUCTION (ENG., BUL., GRE. & RUS.)	1	-	-	
49	CAPACITOR - VACUUM PUMP (1.2µF, 440 VAC)	1	DS441125BLQA	←	
50	FLEXIBLE PIPE COMPLETE	1	CWH85C1021	←	
51	VACUUM PUMP	1	CWB532034	←	O
52	FILTER - OXYGEN GENERATOR	1	CWD071010	←	O
53	FLEXIBLE PIPE COMPLETE	1	CWH851087	←	
54	TUBE CONNECTOR COMPLETE	1	CWT29C1021	←	
55	FLEXIBLE PIPE COMPLETE	1	CWH85C1027	CWH85C1013	
56	SOUND PROOF BOARD	1	CWH151071	←	
57	PACKING-L TUBE	1	CWB81012	←	
58	FLARE NUT	1	CWT25086 (1/4")	←	
59	FLARE NUT	1	CWT25087 (3/8")	CWT25096 (1/2")	
60	INSTALLATION INSTRUCTION OXYGEN TUBE	1	CWF612774	←	
61	INSTALLATION INSTRUCTION OXYGEN TUBE	1	CWF612775	←	
62	FUSE CAP TERMINAL	1	K5D203BBA002	←	O
63	FUSE HOLDER	1	K3GB1PH00016	←	O

(Note)

- All parts are supplied from PHAAM, Malaysia (Vendor Code: 061).
- "O" marked parts are recommended to be kept in stock.

18 Electronic Circuit Diagram

• CS-XE9DK CS-XE12DK

SCHEMATIC DIAGRAM 1/3

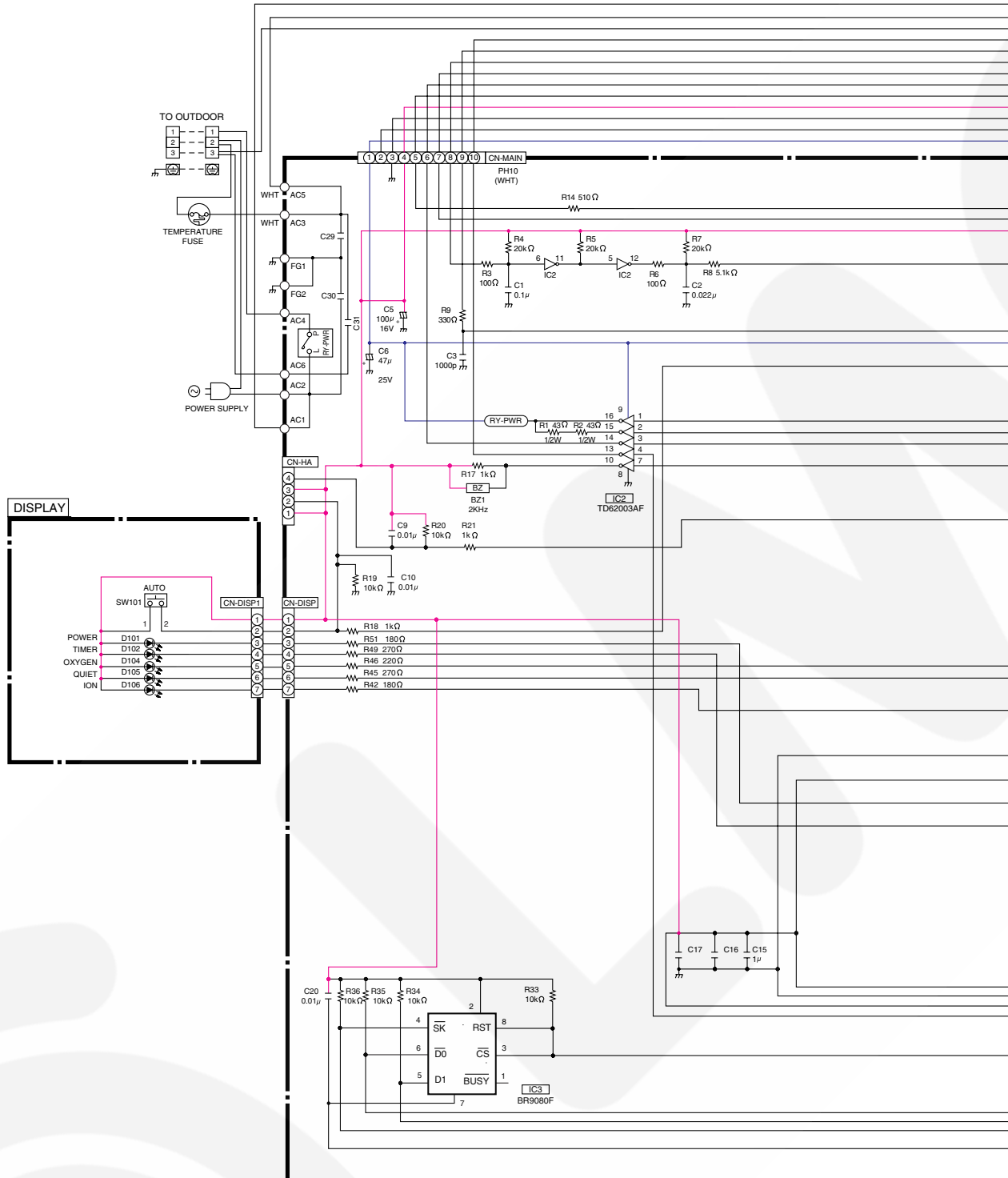

SCHEMATIC DIAGRAM 2/3

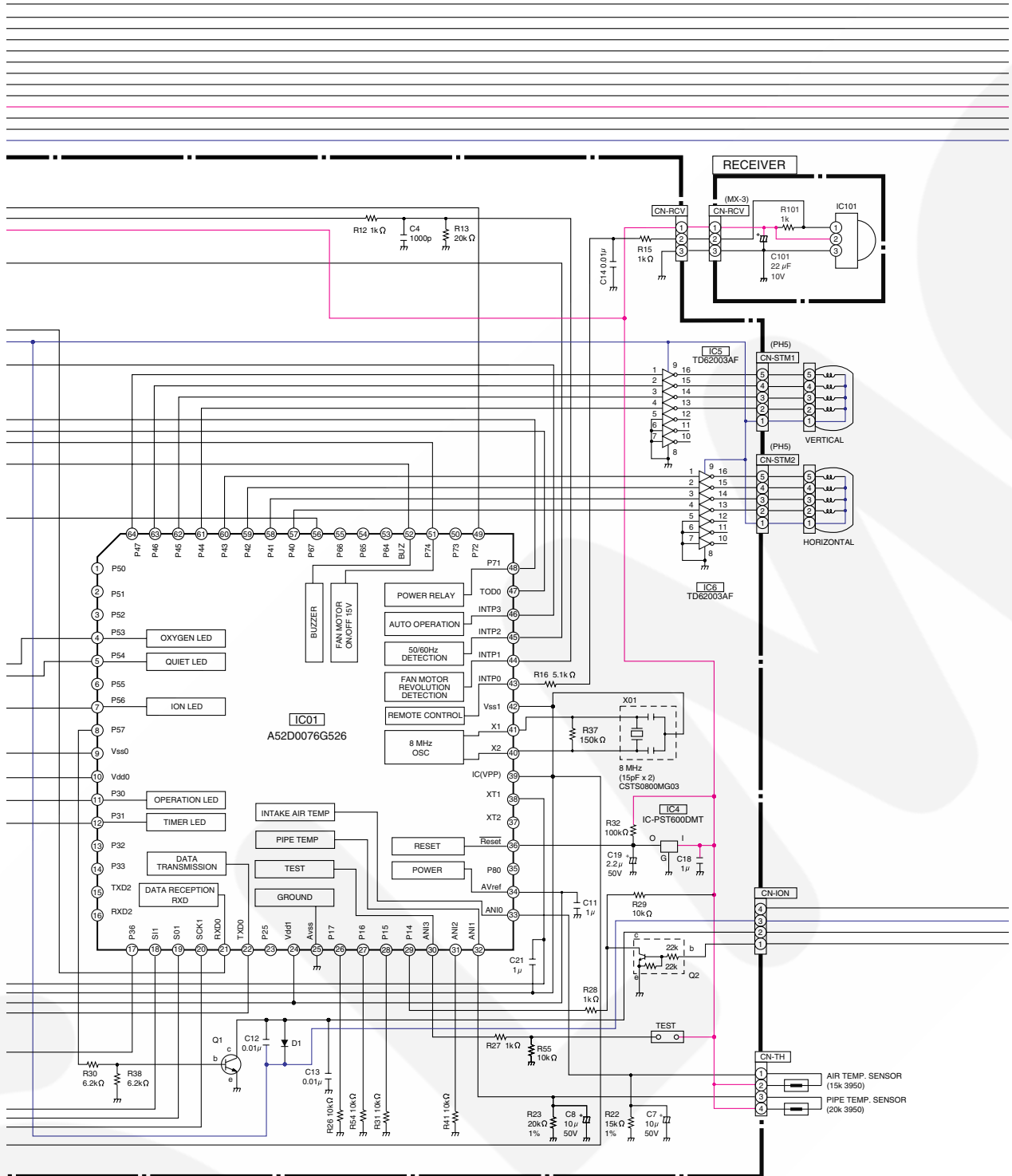

SCHEMATIC DIAGRAM 3/3

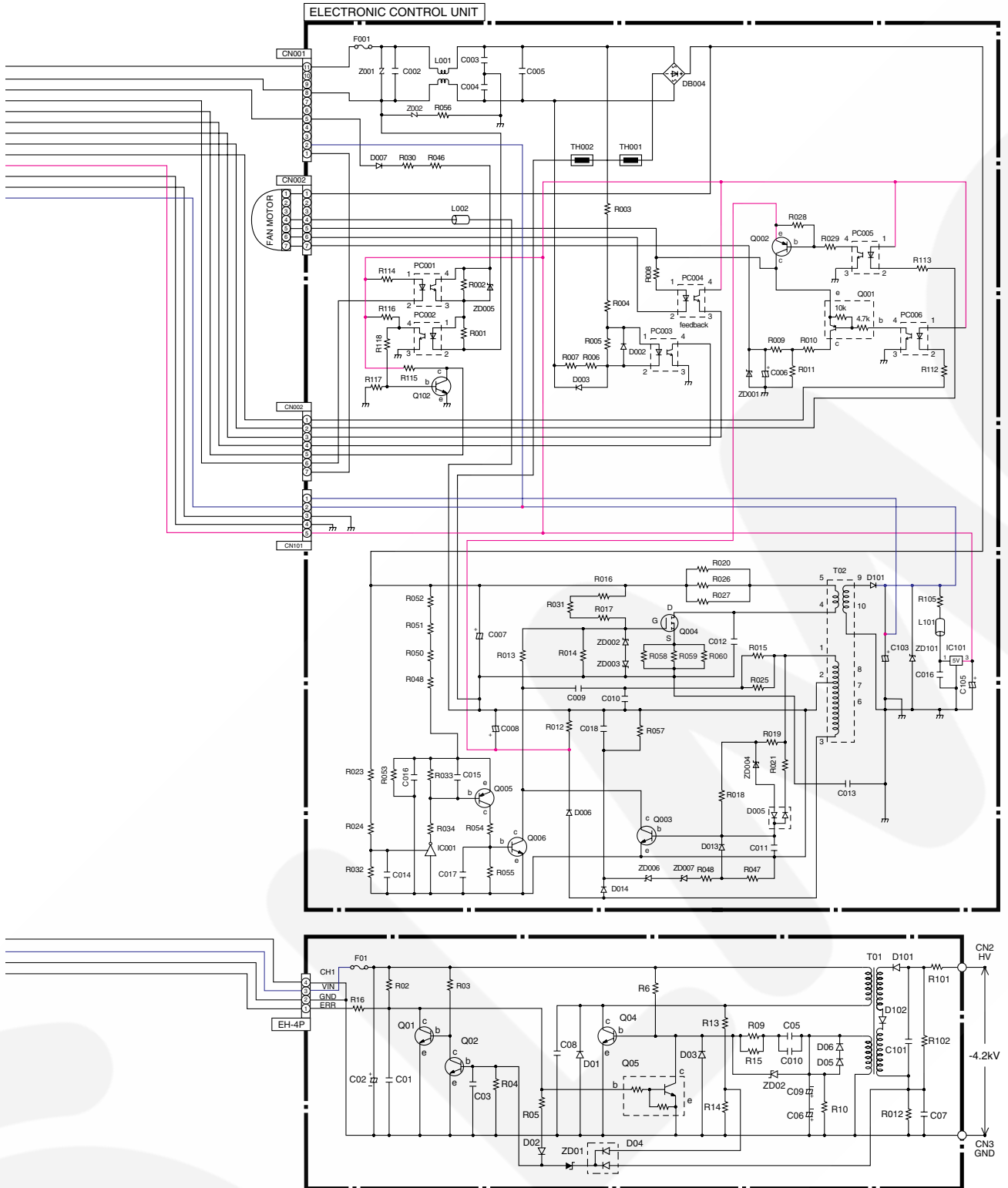

• CU-XE9DK CU-XE12DK
SCHEMATIC DIAGRAM 1/3

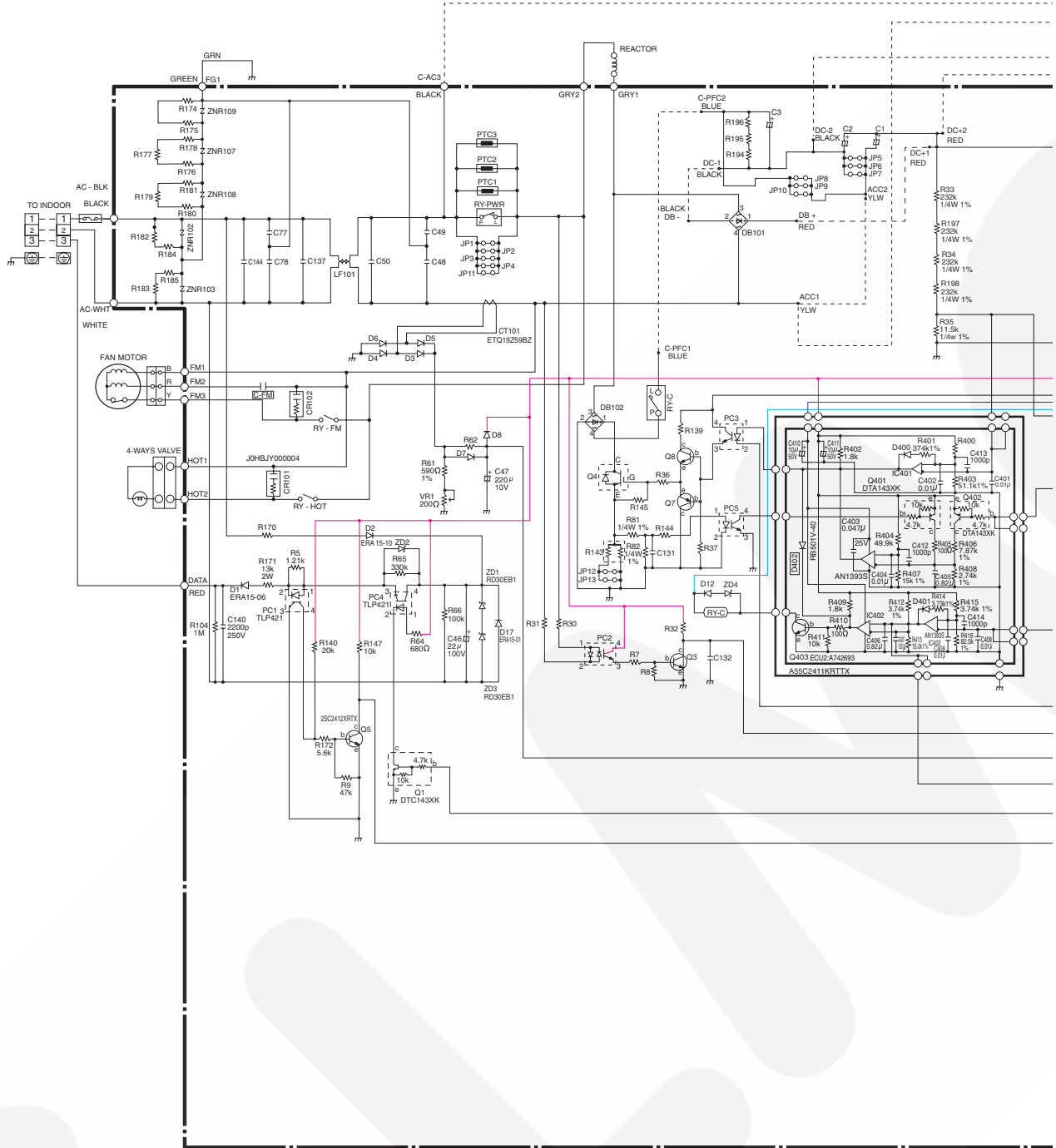

SCHEMATIC DIAGRAM 2/3

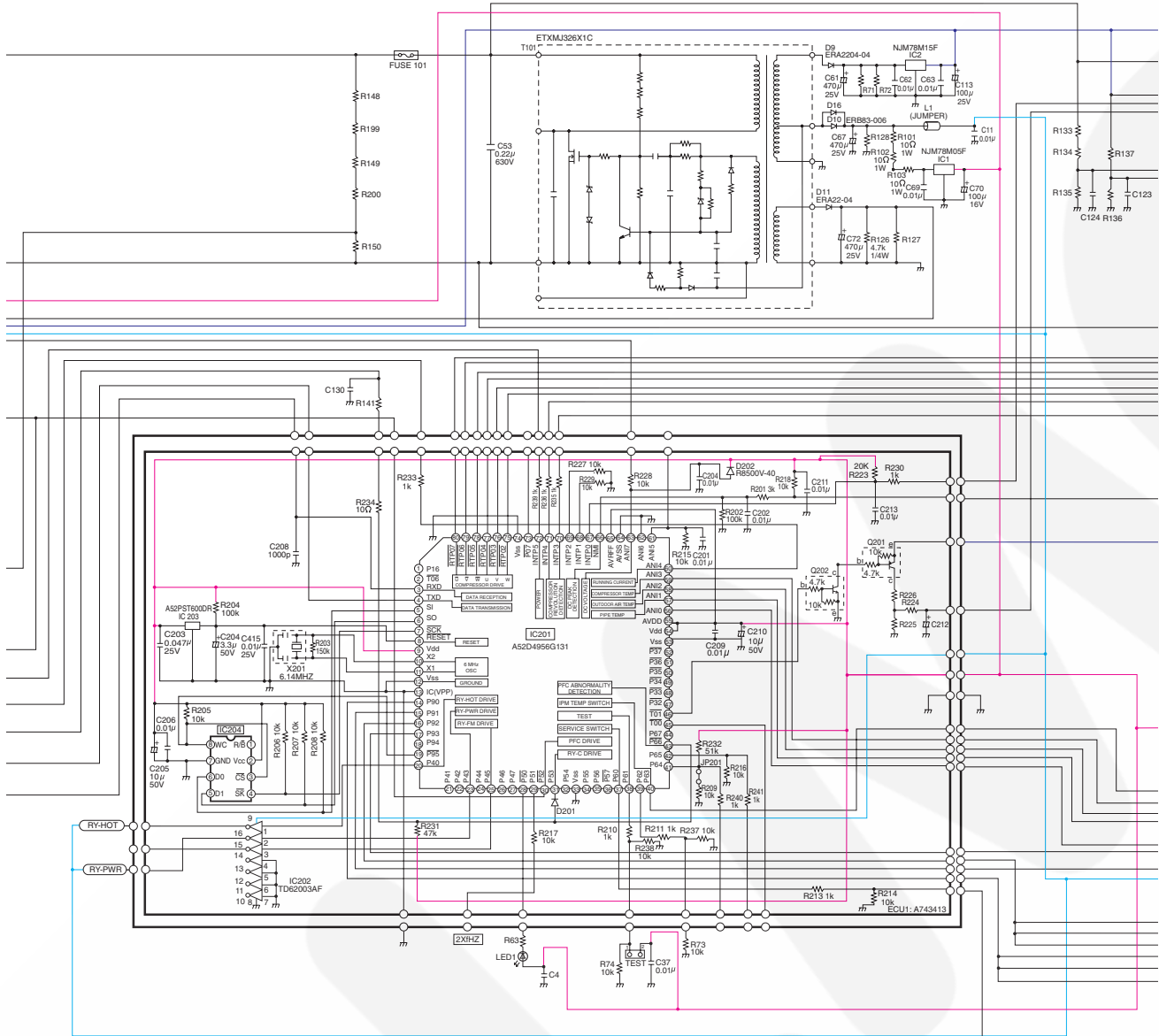

SCHEMATIC DIAGRAM 3/3

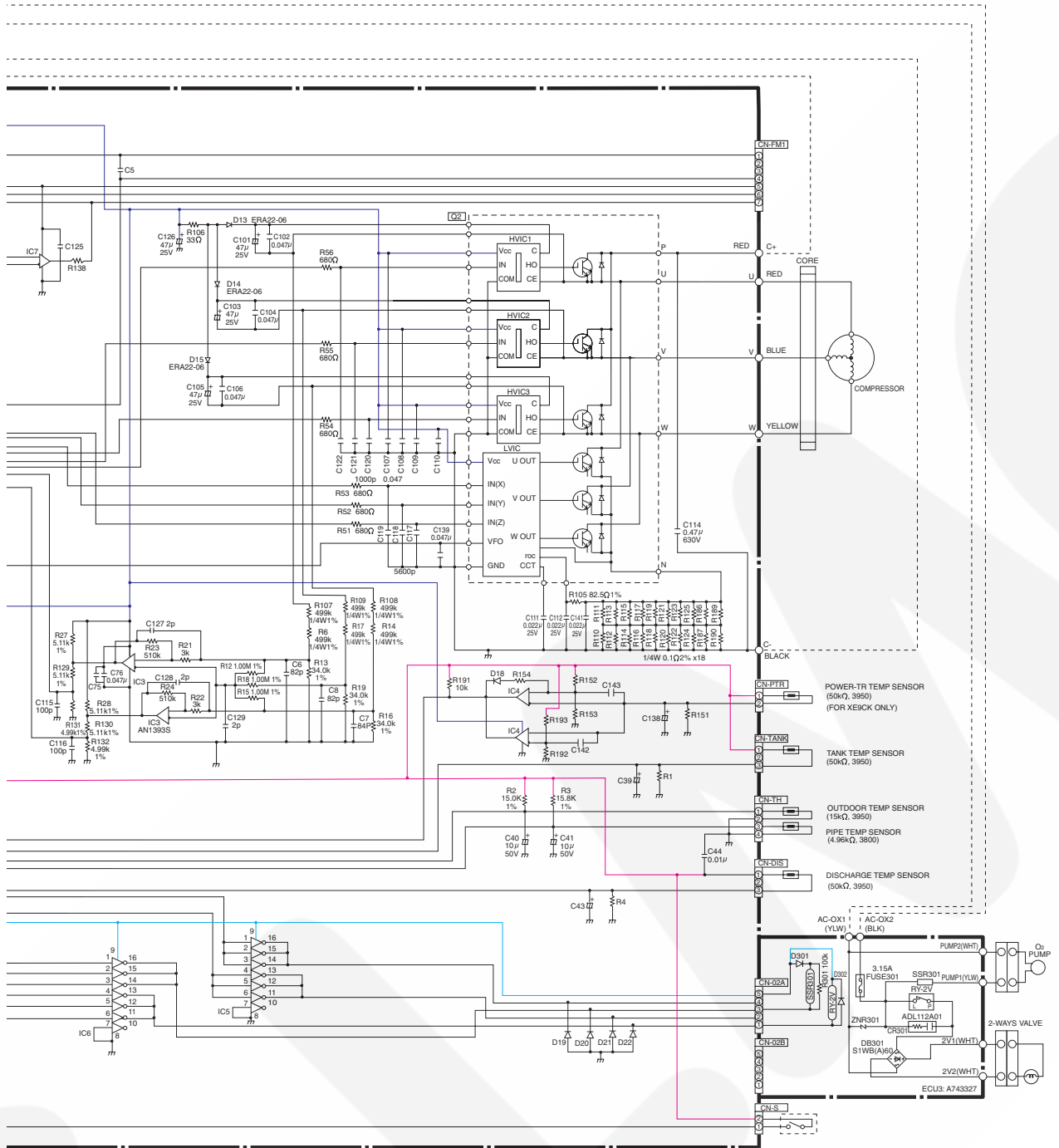

CS-XE9DKE CS-XE12DKE

Fig. 1

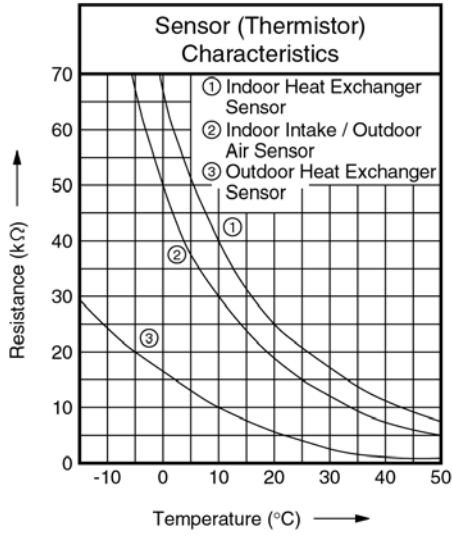
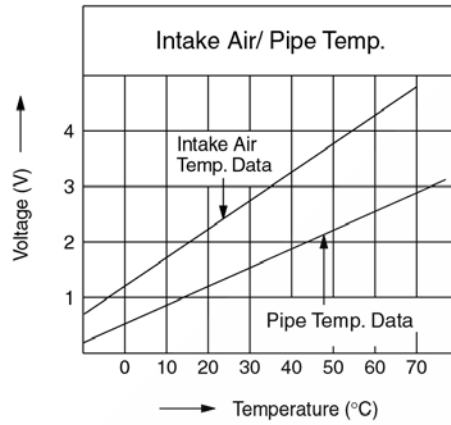

Fig. 2



CU-XE9DKE CU-XE12DKE

Fig. 3

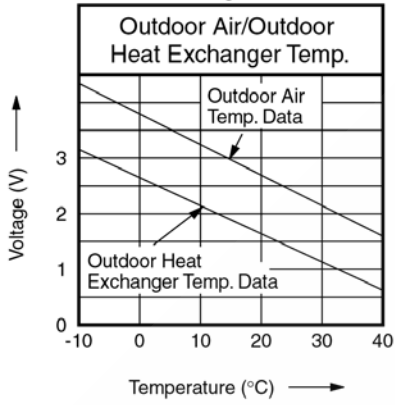

Fig. 4

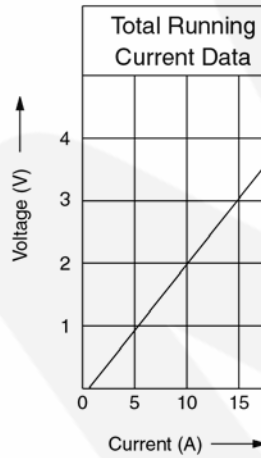

Fig. 5

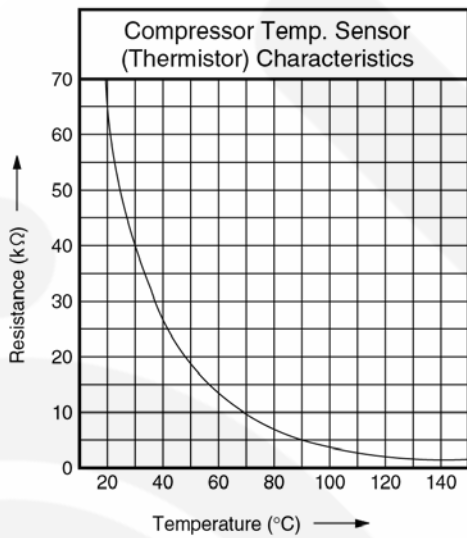
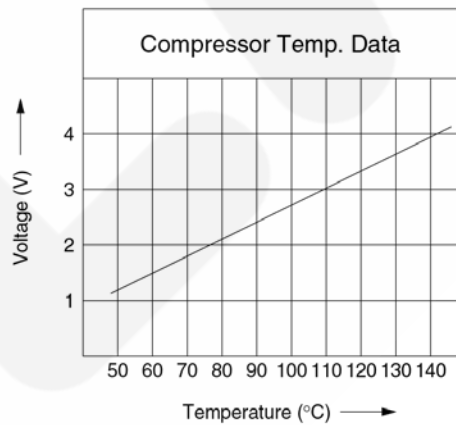

Fig. 6



How to use electronic circuit diagram

Before using the circuit diagram, read the following carefully.

* Voltage measurement

Voltage has been measured with a digital tester when the indoor fan is set at high fan speed under the following conditions without setting the timer.

Use them for servicing.

Voltage indication is in Red at all operations.

* Indications for resistance

a. K...k Ω M...M Ω
 W...watt Not indicated....1/4W

b. Type

Not indicated.....carbon resister

Tolerance \pm 5%



.....metal oxide resister

Tolerance \pm 1%

* Indications for capacitor

a. Unit μ ... μ F P...pF

b. Type Not indicated....ceramic capacitor

(S).....S series aluminium electrolytic capacitor

(Z).....Z series aluminium electrolytic capacitor

(SU).....SU series aluminium electrolytic capacitor

(P).....P series polyester system

(SXE).....SXE series aluminium electrolytic capacitor

(SRA).....SRA series aluminium electrolytic capacitor

(KME).....KME series aluminium electrolytic capacitor

* Diode without indication.....MA165

※ Circuit Diagram is subject to change without notice for further development.

18.1. Remote Control

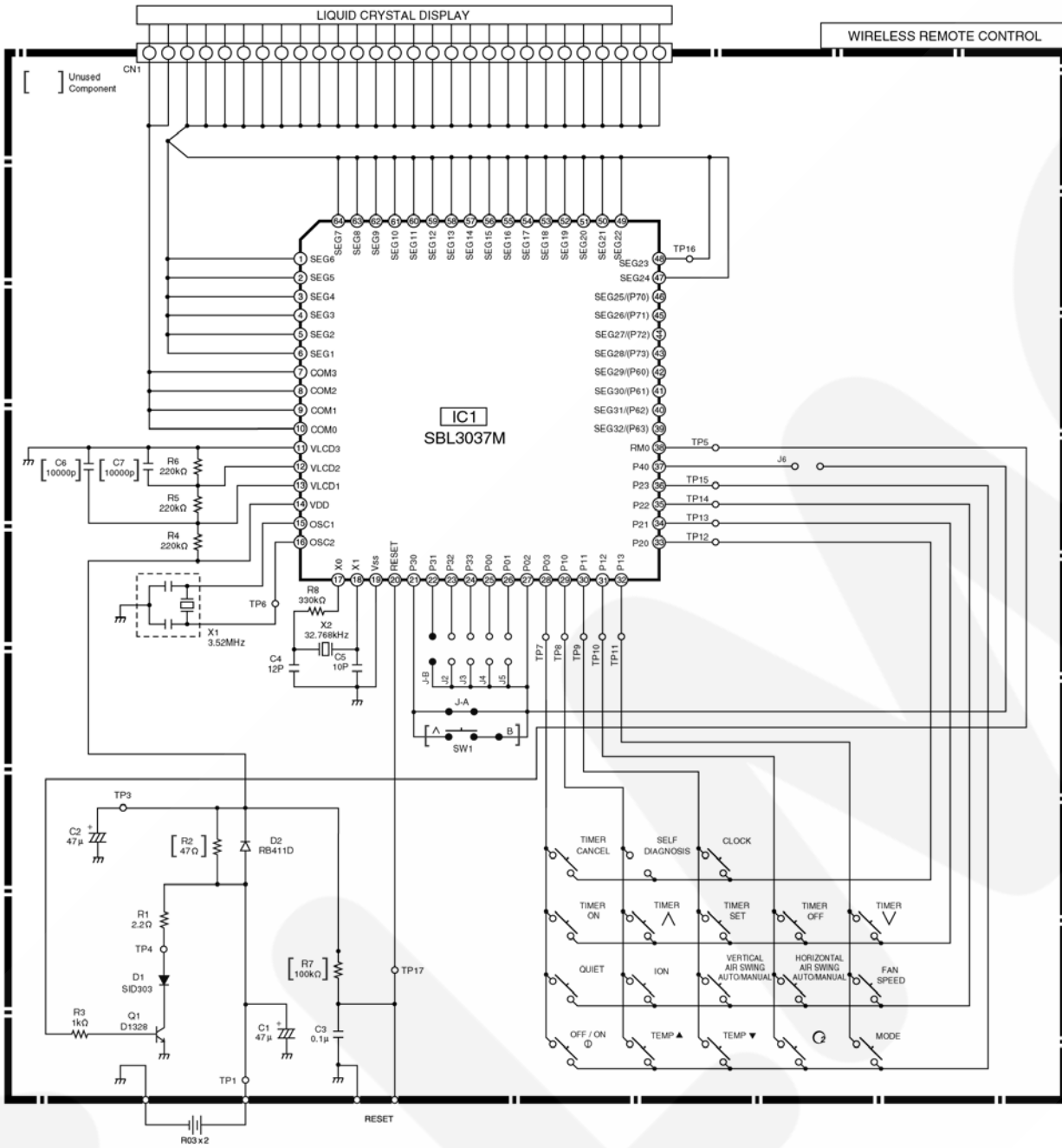

18.2. Print Pattern Indoor Unit Printed Circuit Board (Main)

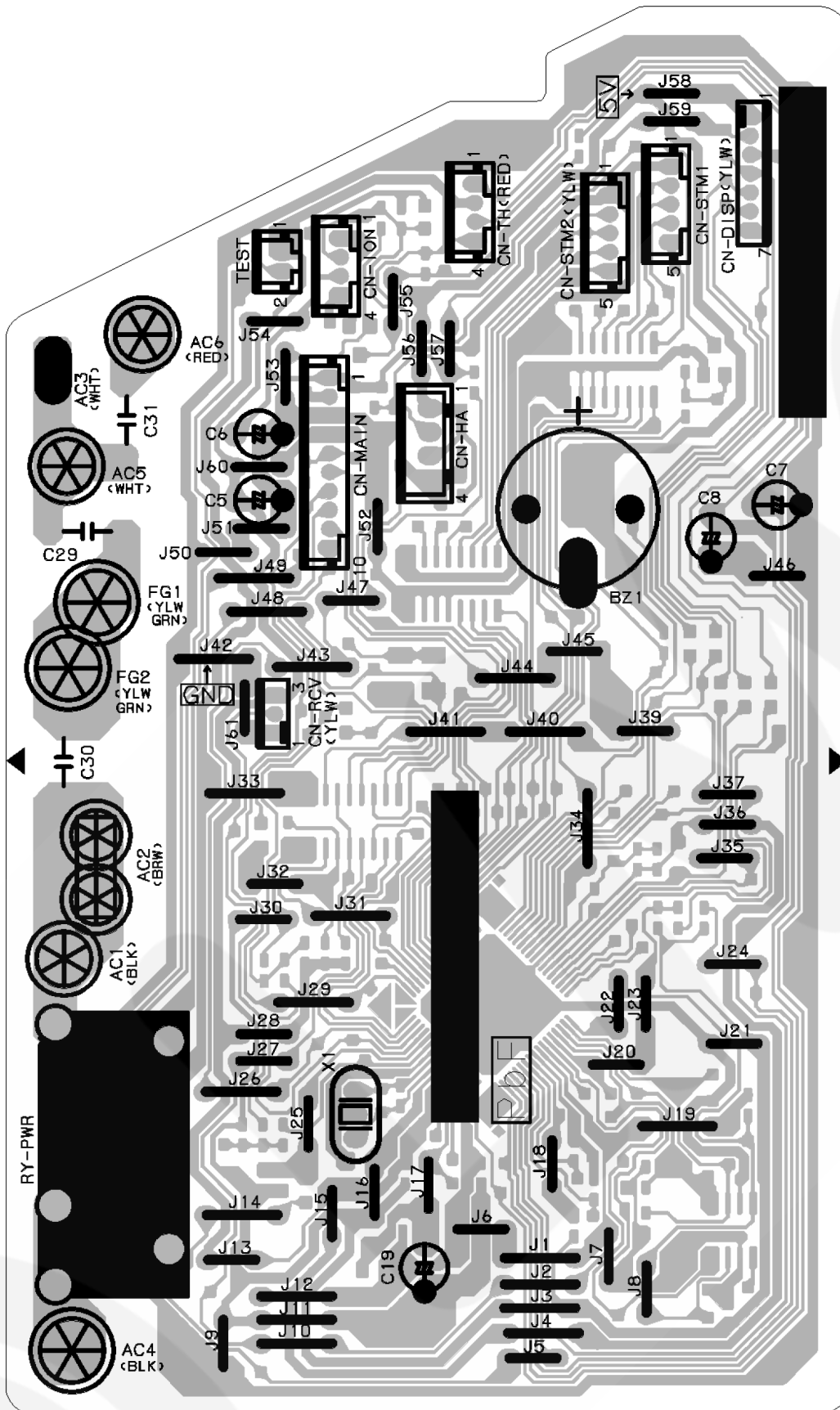

18.3. Print Pattern Indoor Unit Printed Circuit Board (Power)

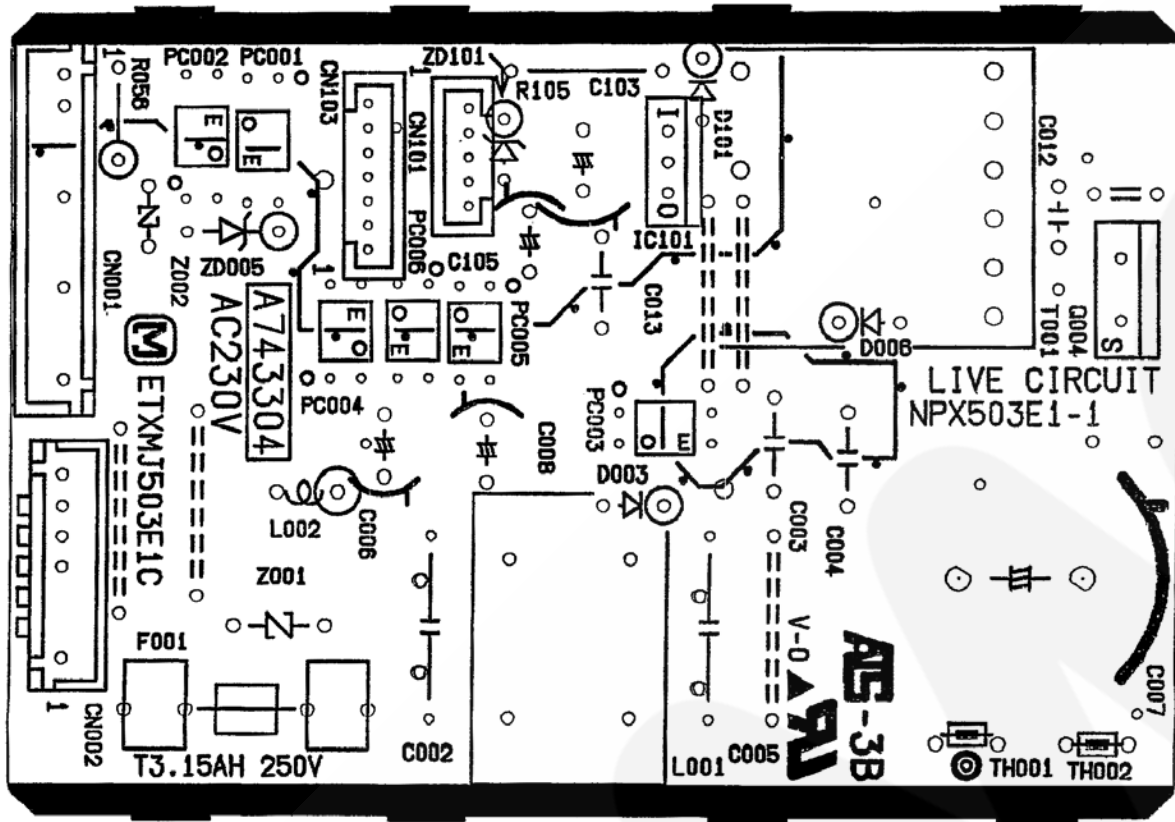

18.4. Print Pattern Indicator Display



18.5. Print Pattern Outdoor Unit Printed Circuit Board (Main)

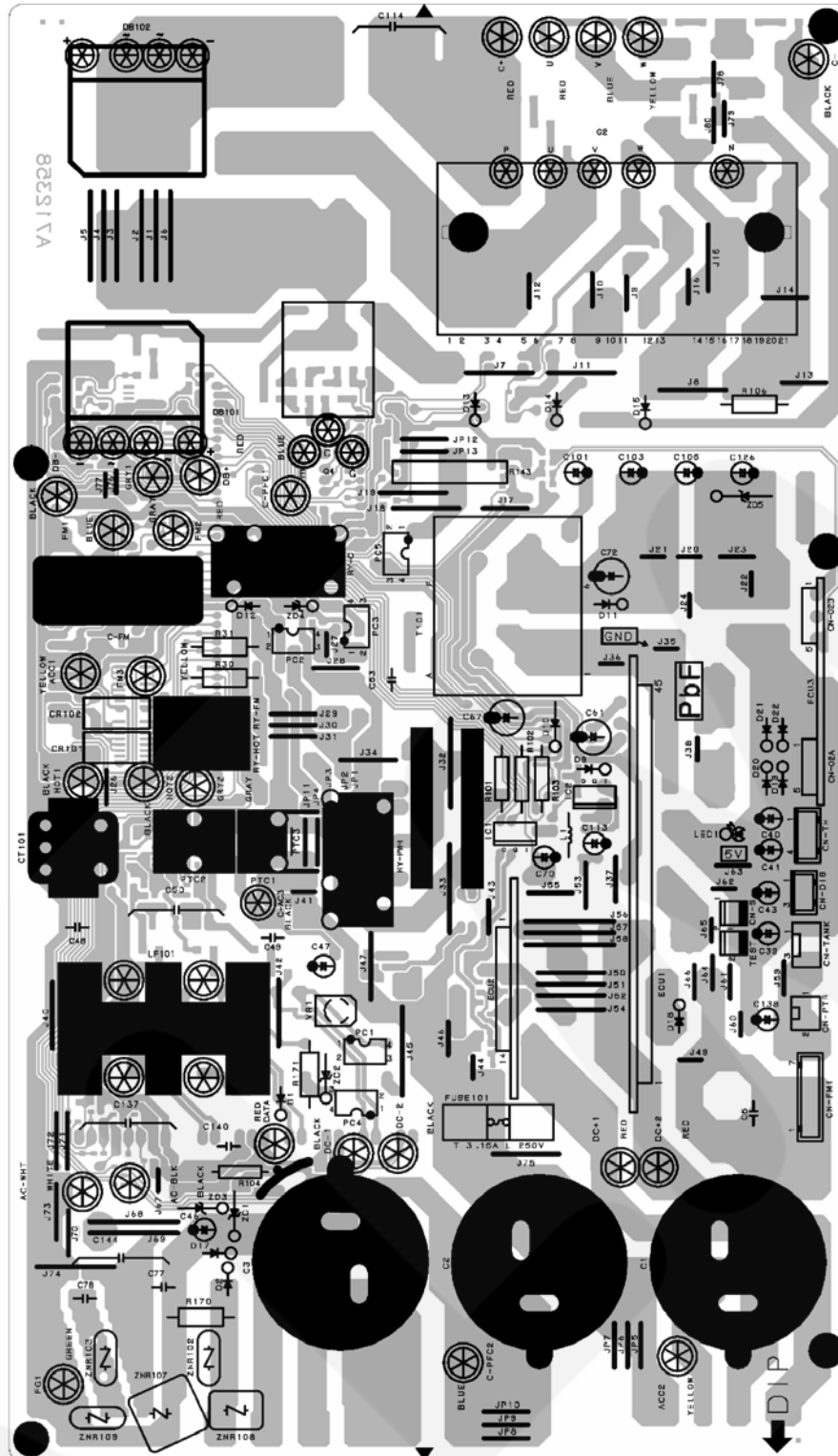

18.6. Print Pattern Outdoor Unit Printed Circuit Board (Oxygen)

