

Service Manual

Air Conditioner

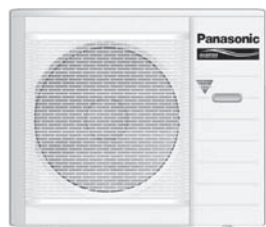
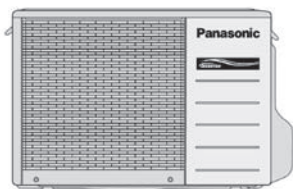

CS-E9GFEW-2 CU-E9GFE-2
CS-E12GFEW-2 CU-E12GFE-2
CS-E18GFEW-2 CU-E18GFE-2
CU-2E15GBE
CU-3E18EBE
CU-3E23CBPG
CU-4E27CBPG

Please file and use this manual together with the Service Manual for Model No. CS-E9GFEW / CU-E9GFE, CS-E12GFEW / CU-E12GFE, CS-E18GFEW / CU-E18GFE, Order No.RAC0704001C2.

⚠ WARNING

This service information is designed for experienced repair technicians only and is not designed for use by the general public. It does not contain warnings or cautions to advise non-technical individuals of potential dangers in attempting to service a product. Products powered by electricity should be serviced or repaired only by experienced professional technicians. Any attempt to service or repair the product or products dealt with in this service information by anyone else could result in serious injury or death.

⚠ PRECAUTION OF LOW TEMPERATURE

In order to avoid frostbite, be assured of no refrigerant leakage during the installation or repairing of refrigeration circuit.

TABLE OF CONTENTS

	PAGE		PAGE
1 Safety Precautions	2	5.2. CS-E18GFEW-2 CU-E18GFE-2	14
2 Specifications	4	6 Wiring Connection Diagram	15
2.1. CS-E9GFEW-2 CU-E9GFE-2	4	6.1. Outdoor Unit.....	15
2.2. CS-E12GFEW-2 CU-E12GFE-2	6	7 Electronic Circuit Diagram	17
2.3. CS-E18GFEW-2 CU-E18GFE-2	8	7.1. Outdoor Unit.....	17
3 Location of Controls and Components	10	8 Disassembly and Assembly Instructions	21
3.1. Indoor Unit.....	10	8.1. Outdoor Unit.....	21
3.2. Outdoor Unit	10	9 Technical Data	23
3.3. Remote Control	10	9.1. Operation Characteristics.....	23
4 Dimensions	11	9.2. Sensible Capacity Chart.....	35
4.1. Outdoor Unit	11	10 Exploded View and Replacement Parts List	36
5 Refrigeration Cycle Diagram	13	10.1. Indoor Unit.....	36
5.1. CS-E9GFEW-2 CU-E9GFE-2CS-E12GFEW- 2 CU-E12GFE-2	13	10.2. CU-E9GFE-2 CU-E12GFE-2.....	39
		10.3. CU-E18GFE-2	41

Panasonic®

© 2008 Panasonic HA Air-Conditioning (M) Sdn. Bhd. (11969-T). All rights reserved. Unauthorized copying and distribution is a violation of law.

1 Safety Precautions

- Read the following "SAFETY PRECAUTIONS" carefully before perform any servicing.
- Electrical work must be installed or serviced by a licensed electrician. Be sure to use the correct rating of the power plug and main circuit for the model installed.
- The caution items stated here must be followed because these important contents are related to safety. The meaning of each indication used is as below. Incorrect installation or servicing due to ignoring of the instruction will cause harm or damage, and the seriousness is classified by the following indications.







 WARNING	This indication shows the possibility of causing death or serious injury.
--	---

 CAUTION	This indication shows the possibility of causing injury or damage to properties.
--	--

- The items to be followed are classified by the symbols:

	This symbol denotes item that is PROHIBITED from doing.
---	---





- Carry out test run to confirm that no abnormality occurs after the servicing. Then, explain to user the operation, care and maintenance as stated in instructions. Please remind the customer to keep the operating instructions for future reference.

 WARNING	
1. Engage dealer or specialist for installation and servicing. If installation or servicing done by the user is defective, it will cause water leakage, electrical shock or fire.	
2. Install according to this installation instructions strictly. If installation is defective, it will cause water leakage, electrical shock or fire.	
3. Use the attached accessories parts and specified parts for installation and servicing. Otherwise, it will cause the set to fall, water leakage, fire or electrical shock.	
4. Install at a strong and firm location which is able to withstand the set's weight. If the strength is not enough or installation is not properly done, the set will drop and cause injury.	
5. For electrical work, follow the local national wiring standard, regulation and the installation instruction. An independent circuit and single outlet must be used. If electrical circuit capacity is not enough or defect found in electrical work, it will cause electrical shock or fire.	
6. This equipment is strongly recommended to install with Earth Leakage Circuit Breaker (ELCB) or Residual Current Device (RCD). Otherwise, it may cause electrical shock and fire in case equipment breakdown or insulation breakdown.	
7. Use the specified cable and connect tightly for indoor/outdoor connection. Connect tightly and clamp the cable so that no external force will be acted on the terminal. If connection or fixing is not perfect, it will cause heat-up or fire at the connection.	
8. Wire routing must be properly arranged so that control board cover is fixed properly. If control board cover is not fixed perfectly, it will cause heat-up or fire at connection point of terminal, fire or electrical shock.	
9. When carrying out piping connection, take care not to let air substances other than the specified refrigerant go into refrigeration cycle. Otherwise, it will cause lower capacity, abnormal high pressure in the refrigeration cycle, explosive and injury.	
10. Do not install outdoor unit near handrail of veranda. When installing air-conditioner unit at veranda of high rise building, child may climb up to outdoor unit and cross over the handrail and causing accident.	
11. This equipment must be properly earthed. Earth line must not be connected to gas pipe, water pipe, earth of lightning rod and telephone. Otherwise, it may cause electric shock in case equipment breakdown or insulation breakdown.	
12. When connecting the piping, do not allow air or any substances other than the specified refrigerant to enter the refrigeration cycle. Otherwise, this may lower the capacity, cause abnormally high pressure in the refrigeration cycle, and possibly result in explosion and injury.	
13. Do not damage or use unspecified power supply cord. Otherwise it will cause fire or electric shock.	
14. Do not modify the length of the power supply cord or use extension cord, and do not share the single outlet with other electrical appliances. Otherwise, it will cause fire or electric shock.	
15. It is desirable that the amount of residual oil is less than 40 mg/10 m. Thickness of copper pipes used must be more than 0.8 mm. Never use copper pipes thinner than 0.8 mm.	
16. During installation, before run the compressor, confirm the refrigerant pipes are fixed. Operation of compressor without fixing the piping, setting the valves at open condition, a burst may occur and cause injury.	

17. After completion of installation or service, confirm there is no leakage or refrigerant gas. It may generate toxic gas when the refrigerant contacts with fire.

18. Ventilate if there is refrigerant gas leakage during operation. It may cause toxic gas when refrigerant contacts with fire.

 **CAUTION**

- | | |
|---|---|
| 1. Do not install the unit at place where leakage of flammable gas may occur. In case gas leaks and accumulates at surrounding of the unit, it may cause fire. |  |
| 2. Carry out drainage piping as mentioned in installation instructions. If drainage is not perfect, water may enter the room and damage the furniture. | |
| 3. Tighten the flare nut with torque wrench according to specified method. If the flare nut is over-tightened, after a long period, the flare may break and cause refrigerant gas leakage. | |
| 4. Do not touch outdoor unit air inlet and aluminium fin. It may cause injury. |  |
| 5. Select an installation location which is easy for maintenance. | |
| 6. Pb free solder has a higher melting point than standard solder; typically the melting point is 50°F - 70°F (30°C - 40°C) higher. Please use a high temperature solder iron. In case of the soldering iron with temperature control, please set it to 700 ± 20°F (370 ± 10°C). Pb free solder will tend to splash when heated too high (about 1100°F / 600°C). | |
| 7. Power supply connection to the air conditioner. Connect the power supply cord of the air conditioner to the mains using one of the following methods.
Power supply point shall be the place where there is ease for access for the power disconnection in case of emergency. In some countries, permanent connection of this room air conditioner to the power supply is prohibited.
i. Power supply connection to the receptacle using a power plug. Use an approved power plug with earth pin for the connection to the socket.
ii. Power supply connection to a circuit breaker for the permanent connection. Use an approved circuit breaker for the permanent connection. It must be a double pole switch with a minimum 3.5 mm contact gap. | |
| 8. Do not release refrigerant during piping work for installation, servicing, reinstallation and during repairing a refrigerant parts. Take care of the liquid refrigerant, it may cause frostbite. |  |
| 9. Installation work: It may need two people to carry out the installation work. | |
| 10. Do not install this appliance in a laundry room or other location where water may drip from the ceiling, etc. |  |

2 Specifications

2.1. CS-E9GFEW-2 CU-E9GFE-2

ITEM		UNIT	INDOOR UNIT	OUTDOOR UNIT
Performance Test Condition			ISO5151	
C O O L I N G	Capacity	kW	2.50 (0.80 ~ 3.00)	
		kcal/h	2150 (690 ~ 2580)	
		BTU/h	8500 (2700 ~ 10200)	
	EER	W/W	4.39 (4.57 ~ 3.85)	
		kcal/hW	3.77 (3.94 ~ 3.31)	
	Noise Level	dB (A)	High 38, Low 27, QLo 23	High 46
Power level dB		High 54, Low 43, QLo 39	High 59	
H E A T I N G	Capacity	kW	3.60 (0.80 ~ 5.00)	
		kcal/h	3100 (690 ~ 4300)	
		BTU/h	12300 (2700 ~ 17100)	
	COP	W/W	4.16 (4.85 ~ 3.68)	
		kcal/hW	3.58 (4.18 ~ 3.16)	
	Noise Level	dB (A)	High 38, Low 27, QLo 23	High 47
Power level dB		High 54, Low 43, QLo 39	High 60	
Moisture Removal		l/h	1.4	
		pt/h	2.9	
Air Volume	QLo	m ³ /min (ft ³ /min)	Cooling; 5.4 (191) Heating; 5.5 (194)	—
	Lo	m ³ /min (ft ³ /min)	Cooling; 6.2 (217) Heating; 6.2 (221)	—
	Me	m ³ /min (ft ³ /min)	Cooling; 7.7 (270) Heating; 7.9 (280)	—
	Hi	m ³ /min (ft ³ /min)	Cooling; 9.3 (328) Heating; 9.6 (339)	Cooling; 29.8 (1050) Heating; 29.8 (1050)
	SHi	m ³ /min (ft ³ /min)	Cooling; 9.9 (350) Heating; 10.2 (361)	—
Refrigeration Control Device			—	Check Valve & Capillary Tube
Refrigeration Oil		cm ³	—	RB68A (400)
Refrigerant (R410A)		g (oz)	—	965 (34.1)
Dimension	Height	mm (inch)	600 (23-5/8)	540 (21-9/32)
	Width	mm (inch)	700 (27-9/16)	780 (30-23/32)
	Depth	mm (inch)	210 (8-9/32)	289 (11-13/32)
Net Weight		kg (lbs)	14 (31)	34 (75)
Pipe Diameter	Gas	mm (inch)	9.52 (3/8)	
	Liquid	mm (inch)	6.35 (1/4)	
Standard Length		m (ft)	7.5 (24.6)	
Pipe Length Range		m (ft)	3 (9.8) ~ 15 (49.2)	
Height Difference		m (ft)	5 (16.4)	
Additional Gas Amount		g/m (oz/ft)	20 (0.2)	
Refrigeration Charge Less		m (ft)	7.5 (24.6)	
Drain Hose	Inner Diameter	mm	15	—
	Length	mm	220	—
Compressor	Type		—	Hermetic Motor
	Motor Type		—	Brushless (6-pole)
	Rated Output	W	—	700

ITEM		UNIT	INDOOR UNIT	OUTDOOR UNIT	
Fan	Type		Turbo Fan	Propeller Fan	
	Material		ASG	PP	
	Motor Type		Transistor (8-pole)	Induction (6-pole)	
	Input Power	W	—	66.0 - 74.1	
	Output Power	W	48	25	
	Fan Speed	QLo (Cool/Heat)	rpm	360 / 360	—
		Lo (Cool/Heat)	rpm	410 / 410	—
Me (Cool/Heat)		rpm	510 / 520	—	
Hi (Cool/Heat)		rpm	620 / 630	745 - 790 / -	
SHi (Cool/Heat)		rpm	660 / 670	—	
Heat Exchanger	Fin Material		Aluminium (Pre Coat)	Aluminium (Pre Coat)	
	Fin Type		Slit Fin	Corrugated Fin	
	Row x Stage x FPI		2 x 22 x 19	2 x 24 x 17	
	Size (W x H x L)	mm	510 x 396 x 24	36.4 x 504 x 713 684	
Air Filter	Material		PET	—	
	Type		Honeycomb	—	

1. Cooling capacities are based on indoor temperature of 27°C Dry Bulb (80.6°F Dry Bulb), 19.0°C Wet Bulb (66.2°F Wet Bulb) and outdoor air temperature of 35°C Dry Bulb (95°F Dry Bulb), 24°C Wet Bulb (75.2°F Wet Bulb)
2. Heating capacities are based on indoor temperature of 20°C Dry Bulb (68°F Dry Bulb) and outdoor air temperature of 7°C Dry Bulb (44.6°F Dry Bulb), 6°C Wet Bulb (42.8°F Wet Bulb)

Item		Unit	
Power Source (Phase, Voltage, Cycle)		ø	Single
		V	220 - 240
		Hz	50
Input Power		W	Cooling; 570 (175 ~ 780) Heating; 865 (165 ~ 1360)
Starting Current		A	4.20
Running Current		A	Cooling; 2.75 - 2.65 Heating; 4.20 - 3.90
Maximum current		A	6.15
Power Factor		%	Cooling; 94 - 90 Heating; 94 - 92
Power factor means total figure of compressor, indoor fan motor and outdoor fan motor.			
Power Cord	Number of core		—
	Length	m	—
Thermostat			Electronic Control
Protection Device			Electronic Control

Note

- Specifications are subject to change without notice for further improvement.

2.2. CS-E12GFEW-2 CU-E12GFE-2

ITEM		UNIT	INDOOR UNIT	OUTDOOR UNIT
Performance Test Condition			ISO5151	
C O O L I N G	Capacity	kW	3.50 (0.80 ~ 3.80)	
		kcal/h	3010 (690 ~ 3270)	
		BTU/h	11900 (2700 ~ 13000)	
	EER	W/W	3.63 (4.32 ~ 3.33)	
		kcal/hW	3.12 (3.73 ~ 2.87)	
Noise Level	dB (A)	High 39, Low 28, QLo 24	High 48	
	Power level dB	High 55, Low 44, QLo 40	High 61	
H E A T I N G	Capacity	kW	4.80 (0.80 ~ 6.10)	
		kcal/h	4130 (690 ~ 5250)	
		BTU/h	16400 (2700 ~ 20800)	
	COP	W/W	3.64 (4.57 ~ 3.45)	
		kcal/hW	3.13 (3.94 ~ 2.97)	
Noise Level	dB (A)	High 39, Low 27, QLo 23	High 50	
	Power level dB	High 55, Low 43, QLo 39	High 63	
Moisture Removal		l/h	2.0	
		pt/h	4.2	
Air Volume	QLo	m ³ /min (ft ³ /min)	Cooling; 5.5 (194) Heating; 5.5 (196)	—
	Lo	m ³ /min (ft ³ /min)	Cooling; 6.4 (225) Heating; 6.3 (223)	—
	Me	m ³ /min (ft ³ /min)	Cooling; 7.9 (278) Heating; 8.2 (288)	—
	Hi	m ³ /min (ft ³ /min)	Cooling; 9.5 (335) Heating; 10.0 (353)	Cooling; 31.0 (1090) Heating; 31.0 (1090)
	SHi	m ³ /min (ft ³ /min)	Cooling; 10.1 (356) Heating; 10.6 (375)	—
Refrigeration Control Device			—	Check Valve & Capillary Tube
Refrigeration Oil		cm ³	—	RB68A (320)
Refrigerant (R410A)		g (oz)	—	980 (34.6)
Dimension	Height	mm (inch)	600 (23-5/8)	540 (21-9/32)
	Width	mm (inch)	700 (27-9/16)	780 (30-23/32)
	Depth	mm (inch)	210 (8-9/32)	289 (11-13/32)
Net Weight		kg (lbs)	14 (31)	34 (75)
Pipe Diameter	Gas	mm (inch)	9.52 (3/8)	
	Liquid	mm (inch)	6.35 (1/4)	
Standard Length		m (ft)	7.5 (24.6)	
Pipe Length Range		m (ft)	3 (9.8) ~ 15 (49.2)	
Height Difference		m (ft)	5 (16.4)	
Additional Gas Amount		g/m (oz/ft)	20 (0.2)	
Refrigeration Charge Less		m (ft)	7.5 (24.6)	
Drain Hose	Inner Diameter	mm	15	—
	Length	mm	220	—
Compressor	Type		—	Hermetic Motor
	Motor Type		—	Brushless (6-pole)
	Rated Output	W	—	700

ITEM		UNIT	INDOOR UNIT	OUTDOOR UNIT	
Fan	Type		Turbo Fan	Propeller Fan	
	Material		ASG	PP	
	Motor Type		Transistor (8-pole)	Induction (6-pole)	
	Input Power	W	—	71.3 - 80.7	
	Output Power	W	48	30	
	Fan Speed	QLo (Cool/Heat)	rpm	370 / 360	—
		Lo (Cool/Heat)	rpm	430 / 410	—
Me (Cool/Heat)		rpm	530 / 530	—	
Hi (Cool/Heat)		rpm	640 / 650	815 - 845 / -	
SHi (Cool/Heat)		rpm	680 / 690	—	
Heat Exchanger	Fin Material		Aluminium (Pre Coat)	Aluminium	
	Fin Type		Slit Fin	Corrugated Fin	
	Row x Stage x FPI		2 x 22 x 19	2 x 24 x 17	
	Size (W x H x L)	mm	510 x 396 x 24	36.4 x 504 x 713 684	
Air Filter	Material		PET	—	
	Type		Honeycomb	—	

- Cooling capacities are based on indoor temperature of 27°C Dry Bulb (80.6°F Dry Bulb), 19.0°C Wet Bulb (66.2°F Wet Bulb) and outdoor air temperature of 35°C Dry Bulb (95°F Dry Bulb), 24°C Wet Bulb (75.2°F Wet Bulb)
- Heating capacities are based on indoor temperature of 20°C Dry Bulb (68°F Dry Bulb) and outdoor air temperature of 7°C Dry Bulb (44.6°F Dry Bulb), 6°C Wet Bulb (42.8°F Wet Bulb)

Item	Unit	
Power Source (Phase, Voltage, Cycle)	∅	Single
	V	220 - 240
	Hz	50
Input Power	W	Cooling; 965 (185 ~ 1140) Heating; 1320 (175 ~ 1770)
Starting Current	A	6.25
Running Current	A	Cooling; 4.60 - 4.25 Heating; 6.25 - 5.80
Maximum current	A	8.70
Power Factor	%	Cooling; 95 - 95 Heating; 96 - 95
Power factor means total figure of compressor, indoor fan motor and outdoor fan motor.		
Power Cord	Number of core	—
	Length	m
Thermostat		Electronic Control
Protection Device		Electronic Control

Note

- Specifications are subject to change without notice for further improvement.

2.3. CS-E18GFEW-2 CU-E18GFE-2

ITEM		UNIT	INDOOR UNIT	OUTDOOR UNIT
Performance Test Condition			ISO5151	
C O O L I N G	Capacity	kW	5.00 (0.90 ~ 5.60)	
		BTU/h	17100 (3100 ~ 19100)	
		kcal/h	4300 (770 ~ 4820)	
	EER	W/W	3.23 (3.53 ~ 2.93)	
		kcal/hW	2.77 (3.02 ~ 2.52)	
Noise Level	dB (A)	High 44, Low 36, QLo 32	High 47	
	Power level dB	High 60, Low 52, QLo 48	High 60	
H E A T I N G	Capacity	kW	5.80 (0.90 ~ 7.10)	
		BTU/h	19800 (3100 ~ 24200)	
		kcal/h	4990 (770 ~ 6110)	
	COP	W/W	3.63 (3.46 ~ 3.02)	
		kcal/hW	3.12 (2.96 ~ 2.60)	
Noise Level	dB (A)	High 44, Low 36, QLo 32	High 48	
	Power level dB	High 60, Low 52, QLo 48	High 61	
Moisture Removal		l/h	2.8	
		pt/h	5.9	
Air Volume	QLo	m ³ /min (ft ³ /min)	Cooling; 7.1 (250) Heating; 7.3 (259)	—
	Lo	m ³ /min (ft ³ /min)	Cooling; 8.3 (291) Heating; 9.1 (322)	—
	Me	m ³ /min (ft ³ /min)	Cooling; 9.6 (337) Heating; 11.1 (390)	—
	Hi	m ³ /min (ft ³ /min)	Cooling; 11.0 (388) Heating; 13.0 (459)	Cooling; 40.0 (1410) Heating; 40.0 (1410)
	SHi	m ³ /min (ft ³ /min)	Cooling; 11.6 (409) Heating; 13.6 (480)	—
Refrigeration Control Device			—	Expansion Valve
Refrigeration Oil		cm ³	—	RB68A (900)
Refrigerant (R410A)		g (oz)	—	1.06k (37.4)
Dimension	Height	mm (inch)	600 (23-5/8)	750 (29-17/32)
	Width	mm (inch)	700 (27-9/16)	875 (34-15/32)
	Depth	mm (inch)	210 (8-9/32)	345 (13-19/32)
Net Weight		kg (lbs)	14 (31)	49 (108)
Pipe Diameter	Gas	mm (inch)	12.7 (1/2)	
	Liquid	mm (inch)	6.35 (1/4)	
Standard Length		m (ft)	7.5 (24.6)	
Pipe Length Range		m (ft)	3 (9.8) ~ 20 (65.6)	
Height Difference		m (ft)	15 (49.2)	
Additional Gas Amount		g/m (oz/ft)	20 (0.2)	
Refrigeration Charge Less		m (ft)	10 (32.8)	
Drain Hose	Inner Diameter	mm	15	—
	Length	mm	220	—
Compressor	Type		—	Hermetic Motor
	Motor Type		—	Brushless (4-pole)
	Rated Output	W	—	900

ITEM		UNIT	INDOOR UNIT	OUTDOOR UNIT	
Fan	Type		Turbo Fan	Propeller Fan	
	Material		ASG	PP	
	Motor Type		Transistor (8-pole)	Transistor (8-pole)	
	Input Power	W	—	62.1	
	Output Power	W	48	40	
	Fan Speed	QLo (Cool/Heat)	rpm	490 / 490	—
		Lo (Cool/Heat)	rpm	570 / 610	—
Me (Cool/Heat)		rpm	660 / 740	—	
Hi (Cool/Heat)		rpm	760 / 870	660 / -	
SHi (Cool/Heat)		rpm	800 / 910	—	
Heat Exchanger	Fin Material		Aluminium (Pre Coat)	Aluminium (Pre Coat)	
	Fin Type		Slit Fin	Corrugated Fin	
	Row x Stage x FPI		2 x 22 x 19	2 x 34 x 16	
	Size (W x H x L)	mm	510 x 396 x 24	36.4 x 714 x 803.2 831.9	
Air Filter	Material		PET	—	
	Type		Honeycomb	—	

1. Cooling capacities are based on indoor temperature of 27°C Dry Bulb (80.6°F Dry Bulb), 19.0°C Wet Bulb (66.2°F Wet Bulb) and outdoor air temperature of 35°C Dry Bulb (95°F Dry Bulb), 24°C Wet Bulb (75.2°F Wet Bulb)
2. Heating capacities are based on indoor temperature of 20°C Dry Bulb (68°F Dry Bulb) and outdoor air temperature of 7°C Dry Bulb (44.6°F Dry Bulb), 6°C Wet Bulb (42.8°F Wet Bulb)

Item	Unit	
Power Source (Phase, Voltage, Cycle)	ø	Single
	V	220 - 240
	Hz	50
Input Power	W	Cooling; 1550 (255 ~ 1910) Heating; 1600 (260 ~ 2350)
Starting Current	A	7.35
Running Current	A	Cooling; 7.20 - 6.90 Heating; 7.35 - 6.95
Maximum current	A	10.5
Power Factor	%	Cooling; 98 - 94 Heating; 99 - 96
Power factor means total figure of compressor, indoor fan motor and outdoor fan motor.		
Power Cord	Number of core	—
	Length	m
Thermostat		Electronic Control
Protection Device		Electronic Control

Note

- Specifications are subject to change without notice for further improvement.

3 Location of Controls and Components

3.1. Indoor Unit

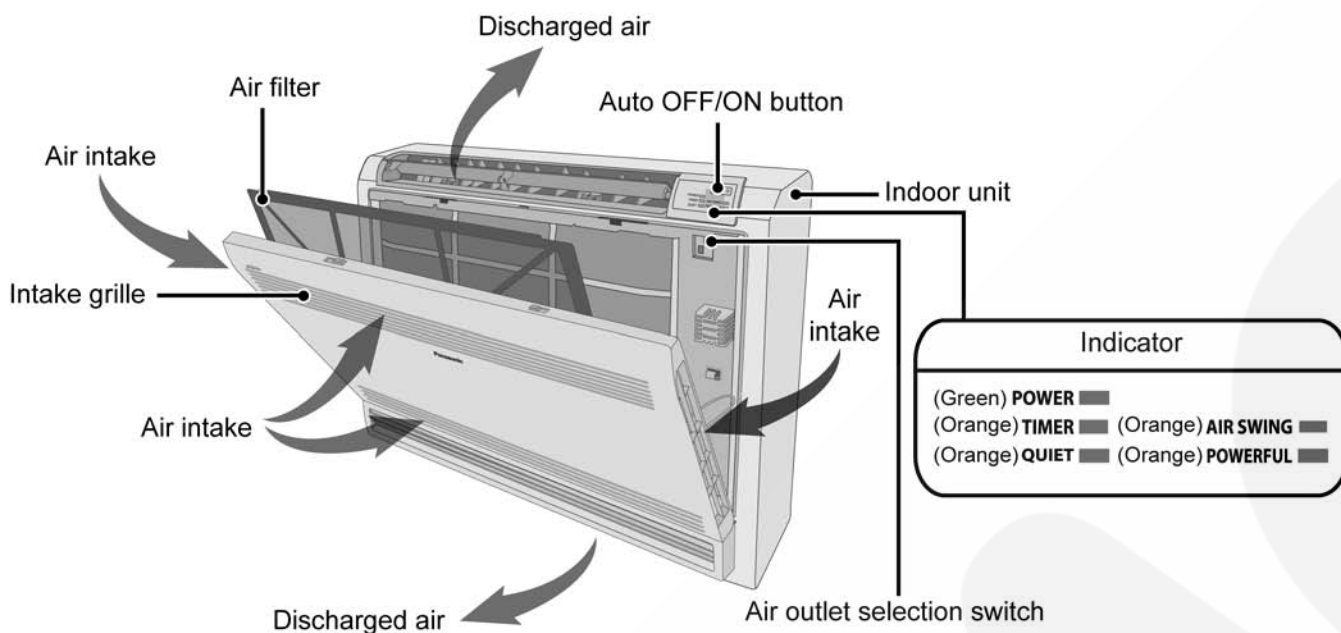

3.2. Outdoor Unit

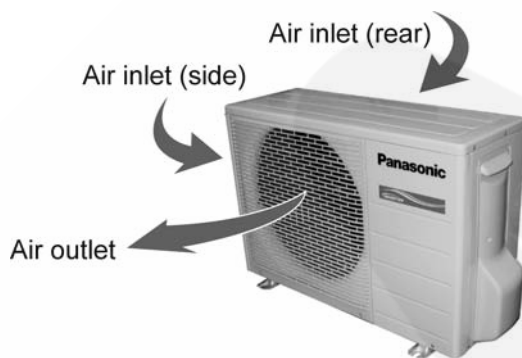

3.3. Remote Control

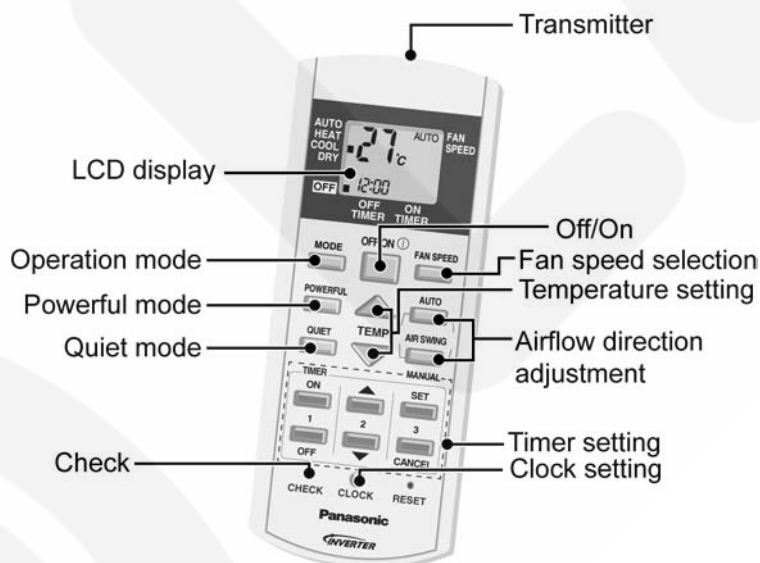

4 Dimensions

4.1. Outdoor Unit

4.1.1. CU-E9GFE-2 CU-E12GFE-2

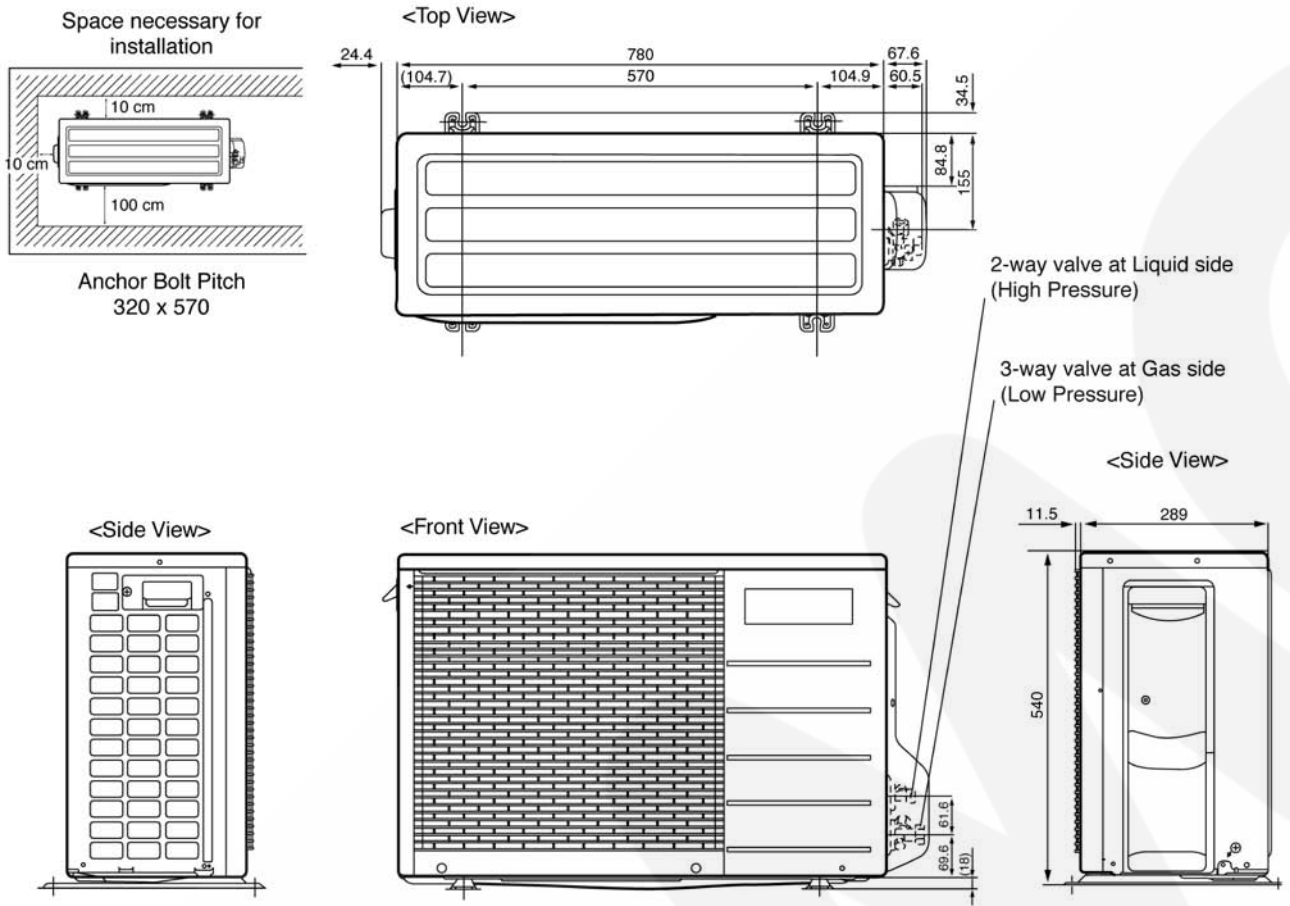

Unit: mm

4.1.2. CU-E18GFE-2

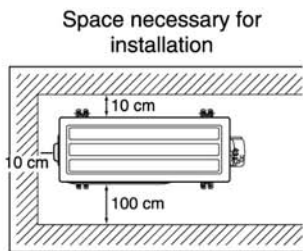

Anchor Bolt Pitch
383 x 612.5

<Top View>

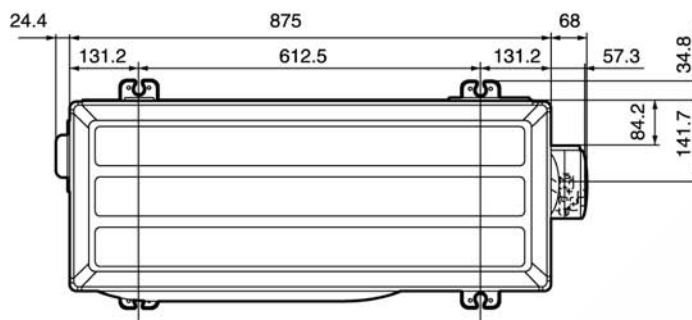

<Side View>

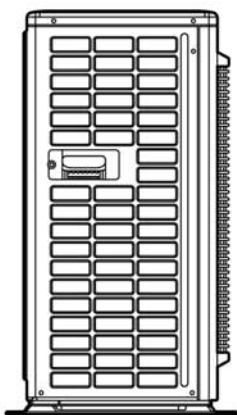

<Front View>

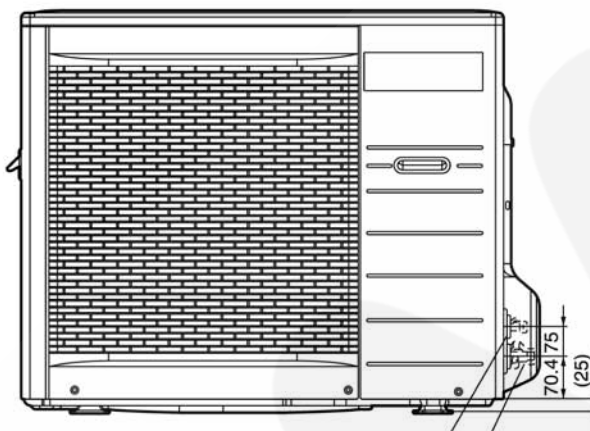

<Side View>

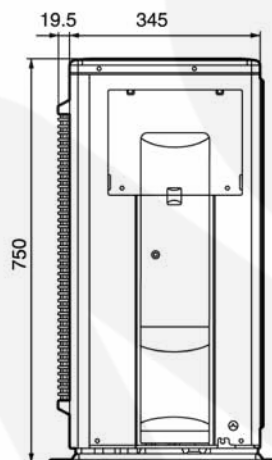

3-way valve at Gas side
(Low Pressure)

2-way valve at Liquid side
(High Pressure)

Unit: mm

5 Refrigeration Cycle Diagram

5.1. CS-E9GFEW-2 CU-E9GFE-2 CS-E12GFEW-2 CU-E12GFE-2

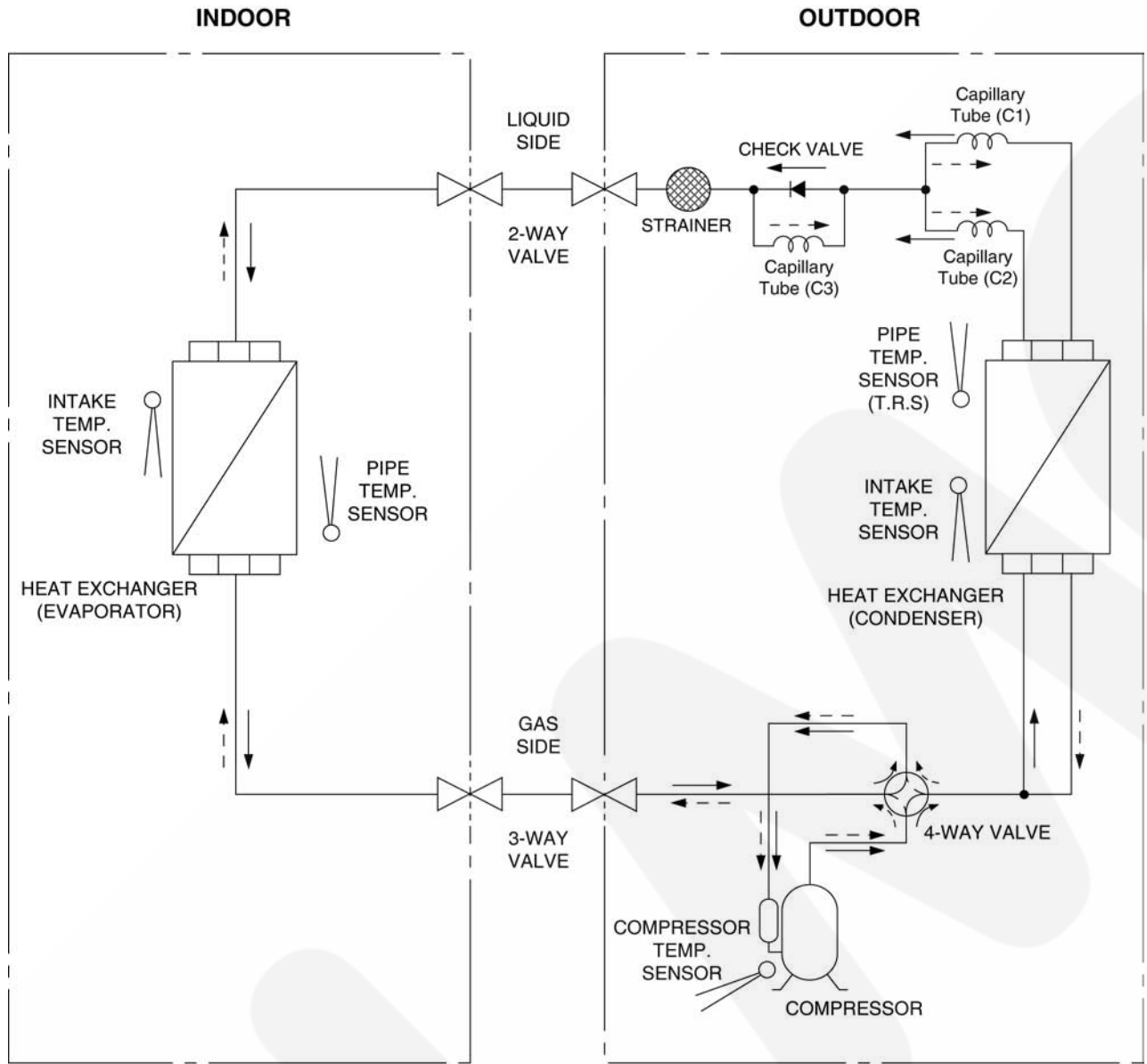

—> COOLING
- -> HEATING

Model	Piping size		Rated Length (m)	Max. Elevation (m)	Min. Piping Length (m)	Max. Piping Length (m)	Additional Refrigerant (g/m)
	Gas	Liquid					
E9GFE-1/E12GFE-1	3/8"	1/4"	7.5	5	3	15	20

⊗ If piping length is over rated length, additional refrigerant should be added as shown in the table.

5.2. CS-E18GFEW-2 CU-E18GFE-2

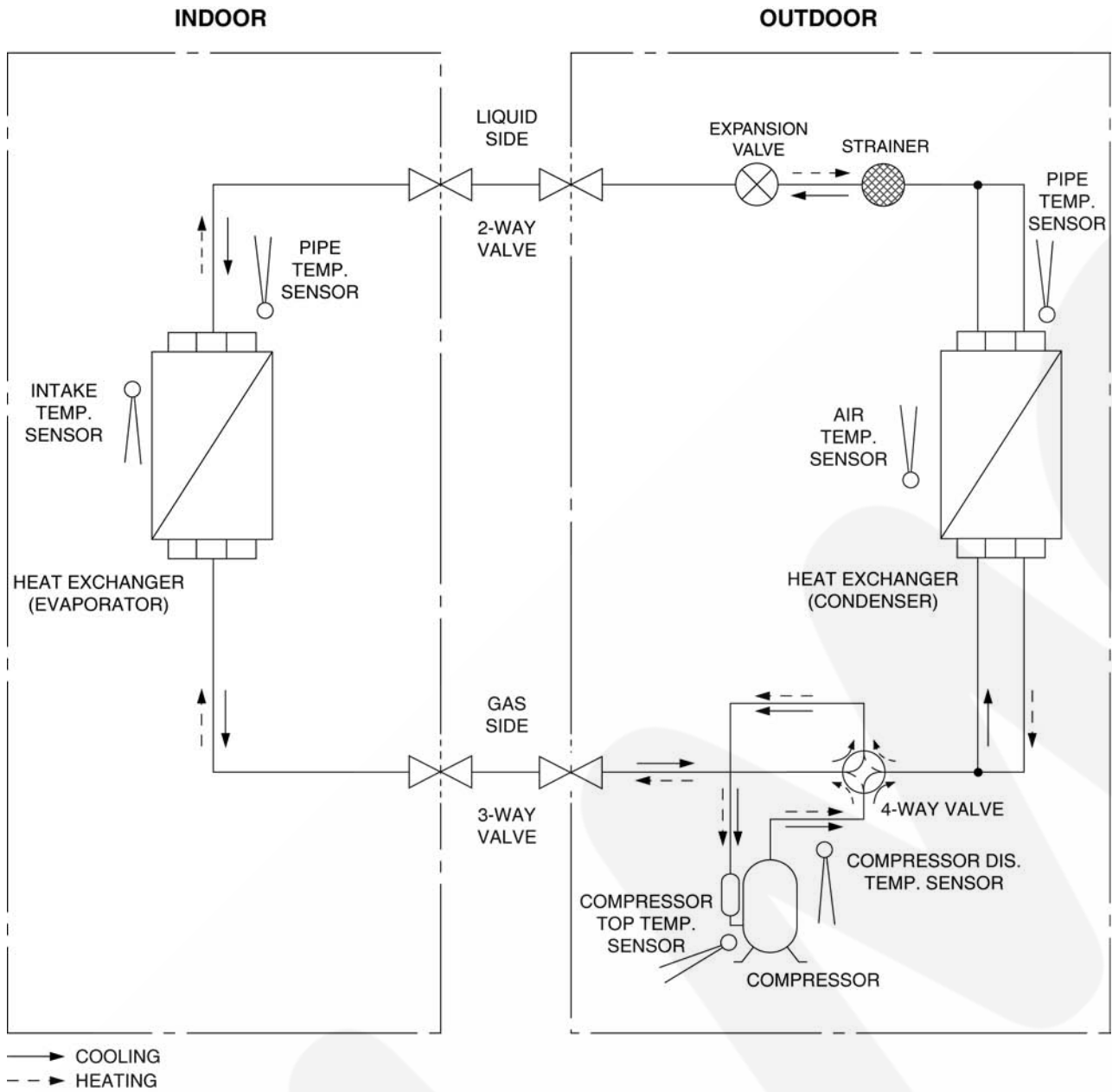

Model	Piping size		Rated Length (m)	Max. Elevation (m)	Min. Piping Length (m)	Max. Piping Length (m)	Additional Refrigerant (g/m)
	Gas	Liquid					
E18GFE-1	1/2"	1/4"	7.5	15	3	20	20

✕ If piping length is over rated length, additional refrigerant should be added as shown in the table.

6 Wiring Connection Diagram

6.1. Outdoor Unit

6.1.1. CU-E9GFE-2 CU-E12GFE-2

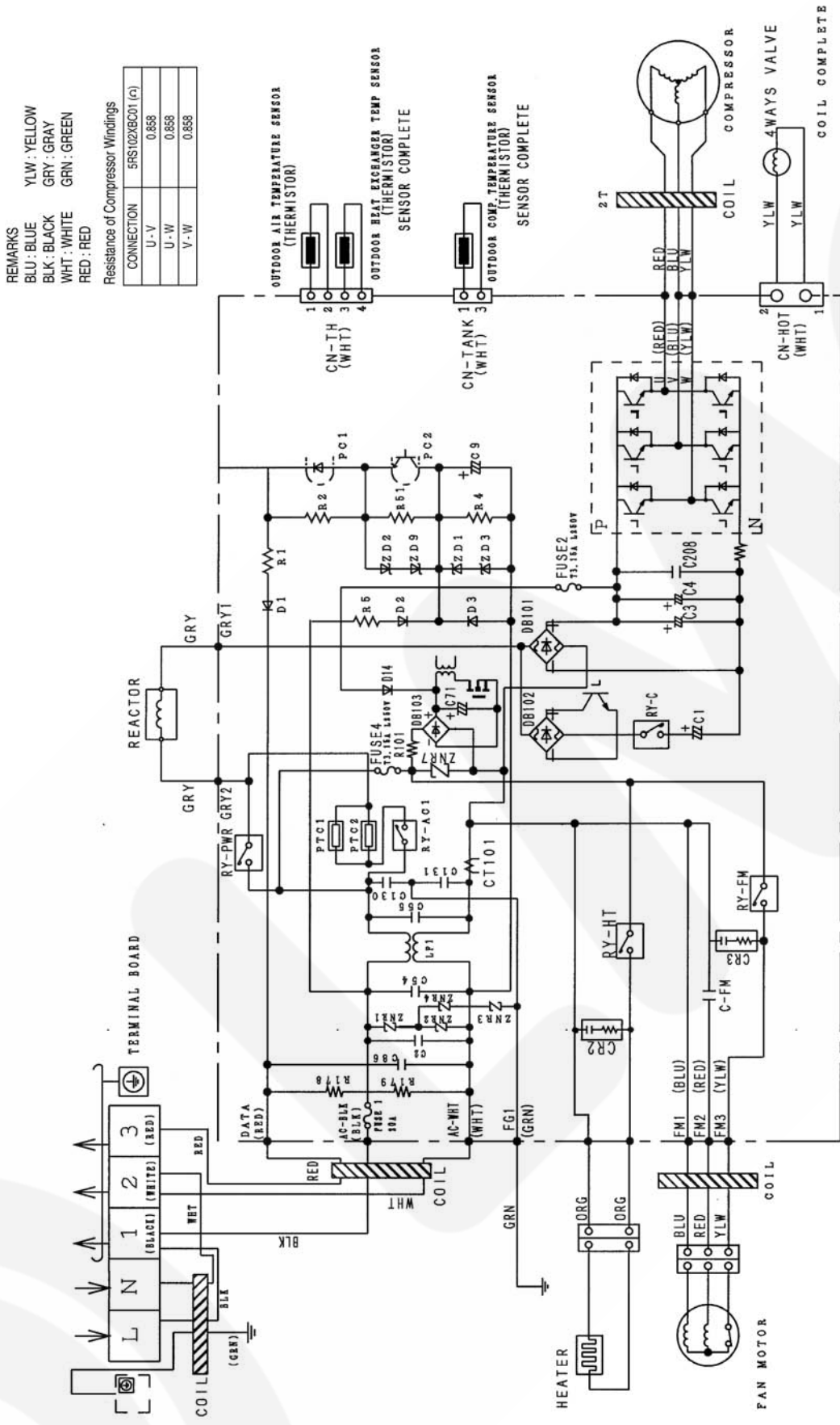

6.1.2. CU-E18GFE-2

Resistance of Compressor Windings

CONNECTION	5CS130XAD04 (Ω)
U - V	0.902
V - W	0.900
U - W	0.903

Note: Resistance at 20°C of ambient temperature

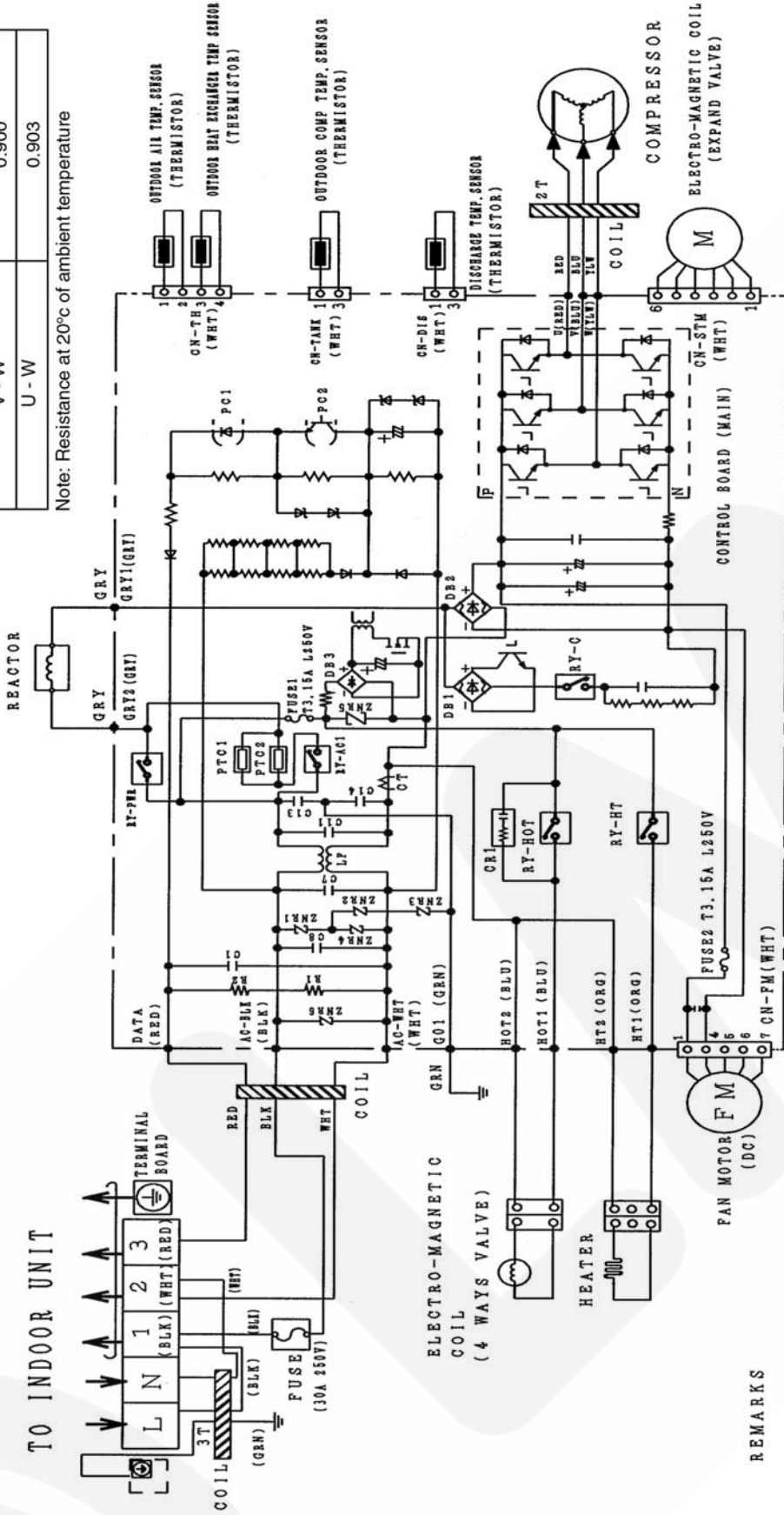

REMARKS

- WHT: WHITE
- RED: RED
- BLU: BLUE
- PNK: PINK
- BLK: BLACK
- YLU: YELLOW
- BRW: BROWN
- ORG: ORANGE
- GRN: GREEN
- GRY: GRAY
- Y/G: YELLOW/GREEN
- YELLOW
- BLUE
- RED
- (TRADEMARK)
- COMP. TERMINAL

7 Electronic Circuit Diagram

7.1. Outdoor Unit

7.1.1. CU-E9GFE-2 CU-E12GFE-2

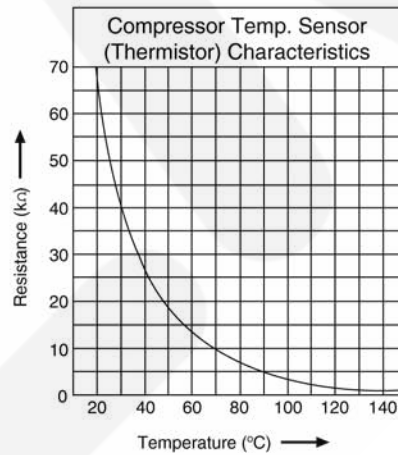
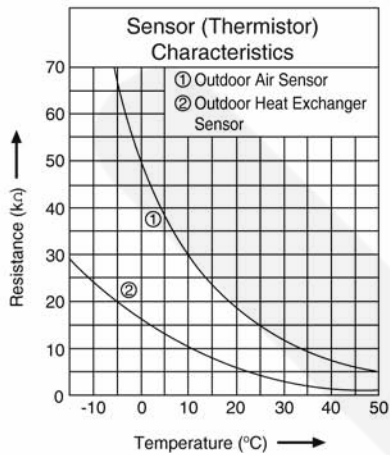
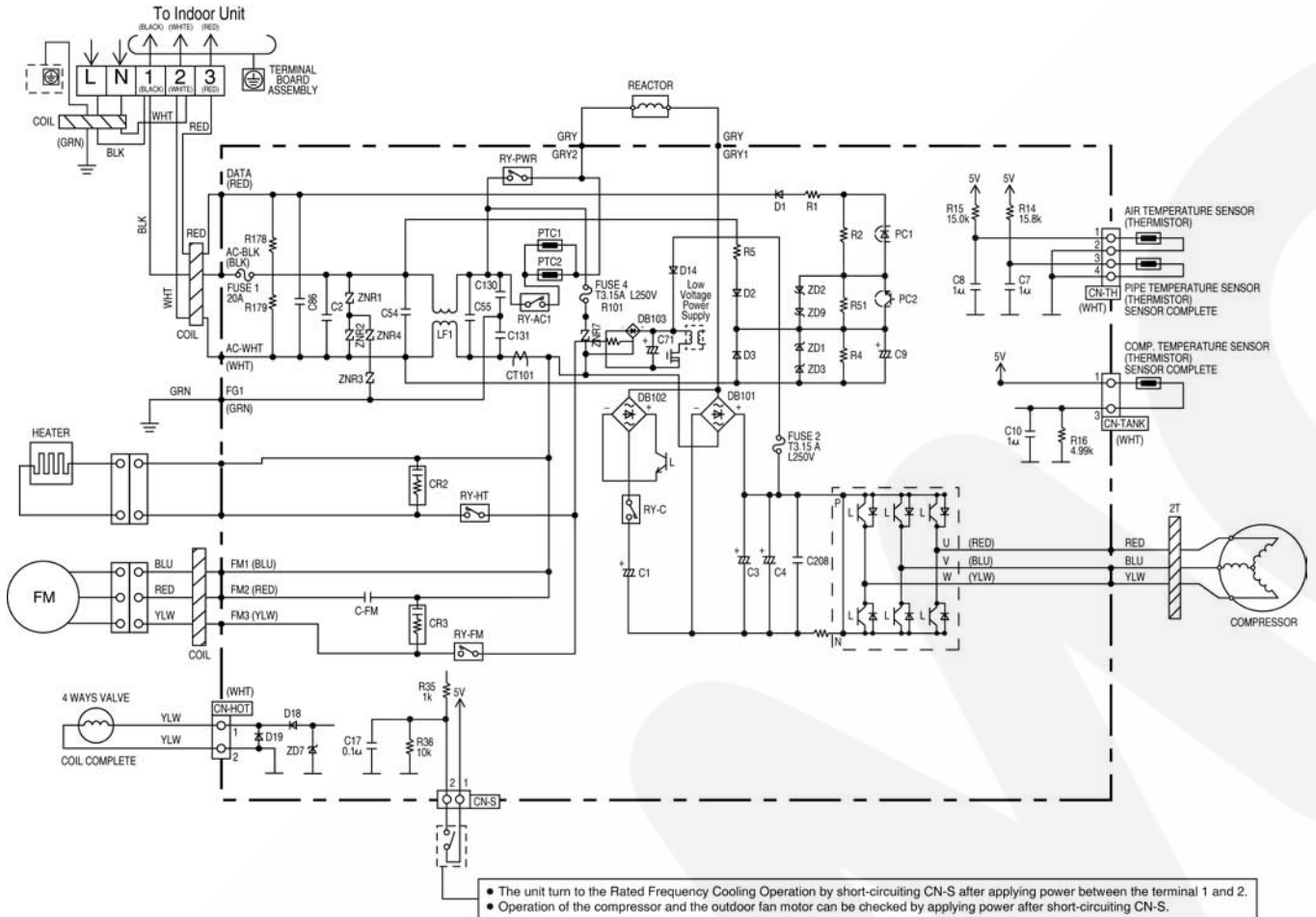

7.1.2. CU-E18GFE-2

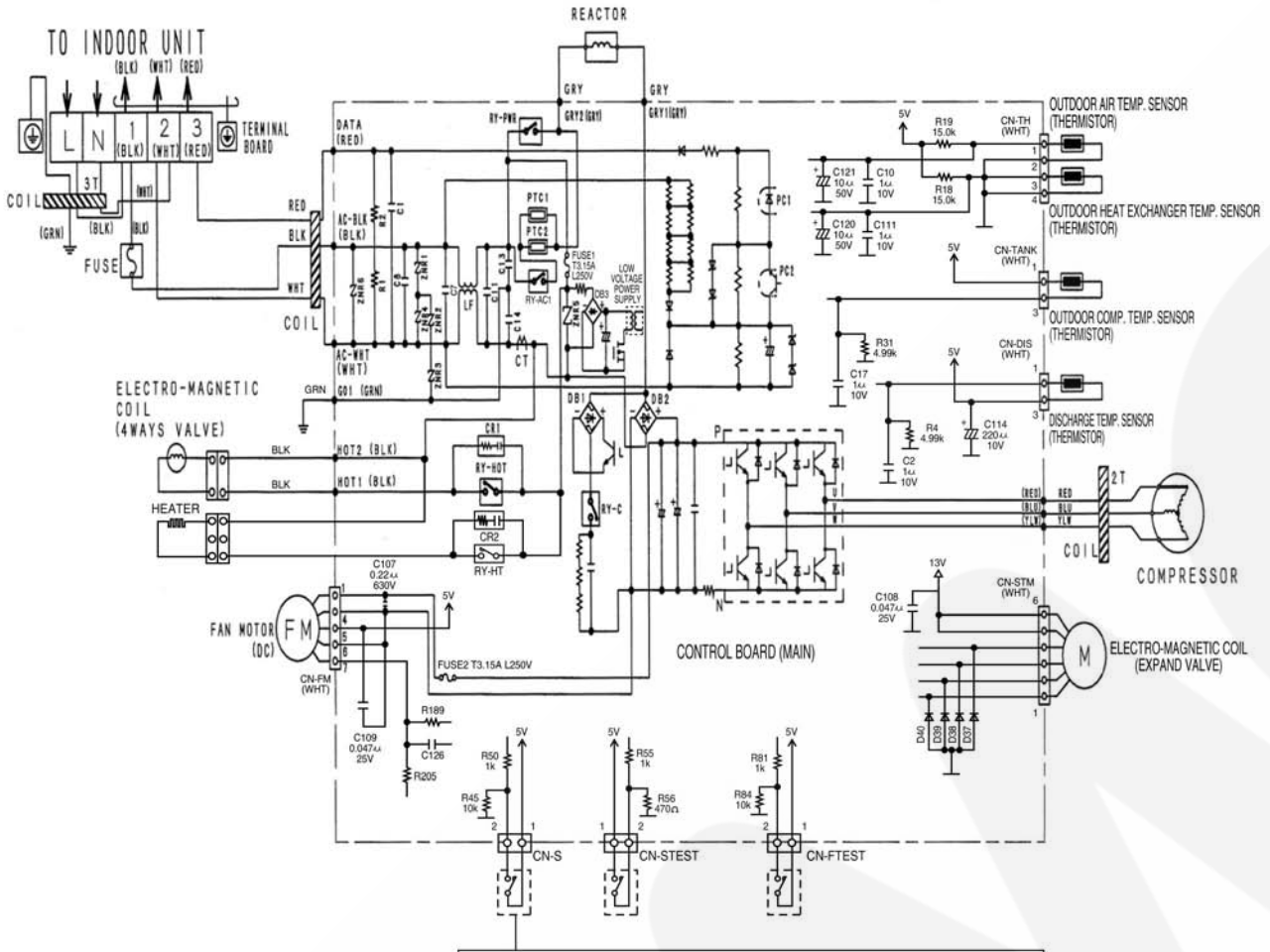

- The unit turn to the Rated Frequency Cooling Operation by short-circuiting CN-S after applying power between the terminal 1 and 2.
- Operation of the compressor and the outdoor fan motor can be checked by applying power after short-circuiting CN-S.

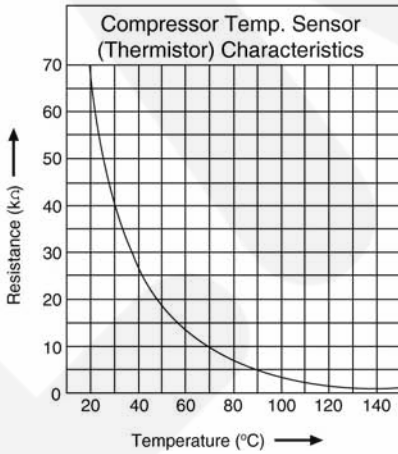
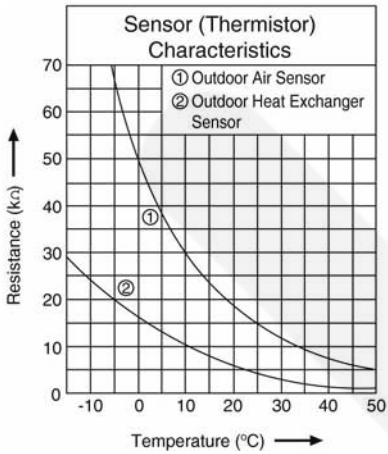

7.1.3. Main Printed Circuit Board CU-E9GFE-2 CU-E12GFE-2

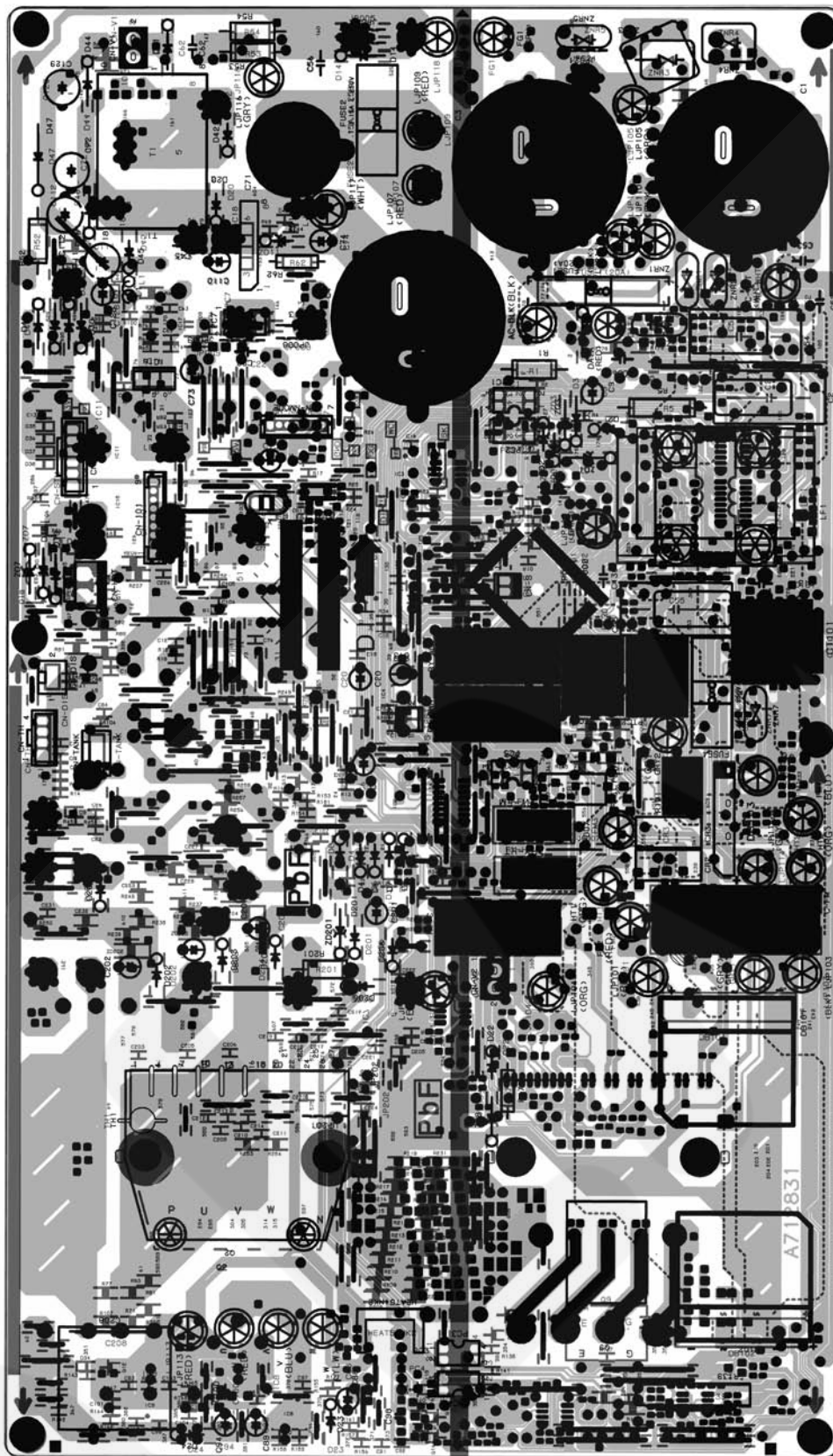

7.1.4. Main Printed Circuit Board
CU-E18GFE-2

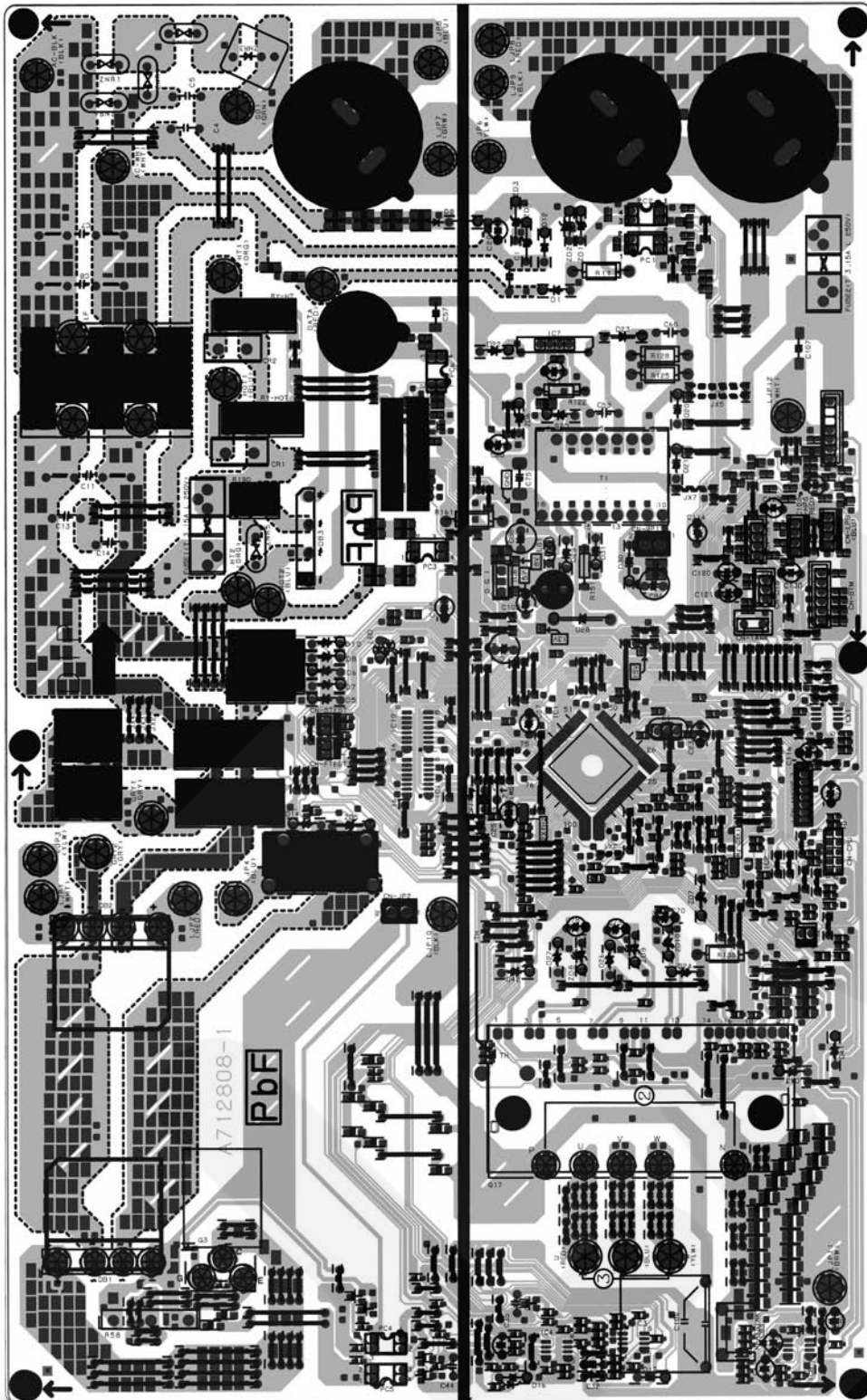

8 Disassembly and Assembly Instructions

8.1. Outdoor Unit

8.1.1. CU-E9GFE-2 CU-E12GFE-2

1. Remove the 3 screws of the Top Panel.

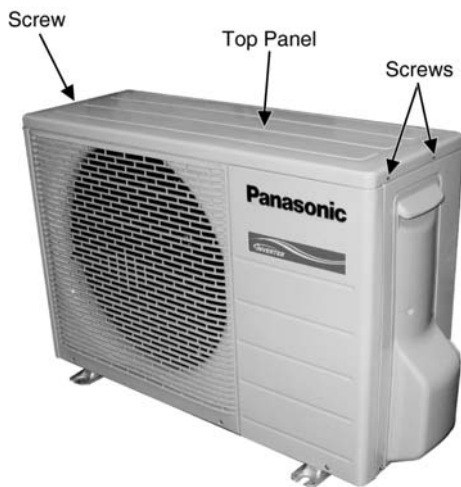

Fig. 13

2. Remove the 6 screws of the Front Panel.

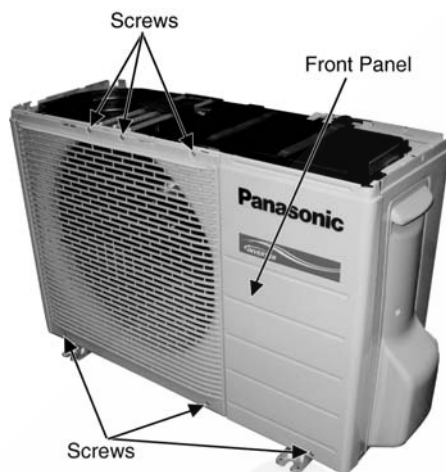

Fig. 14

3. Remove the screw of the Terminal Board Cover.

4. Remove the Top Cover of the Control Board by 4 hooks.

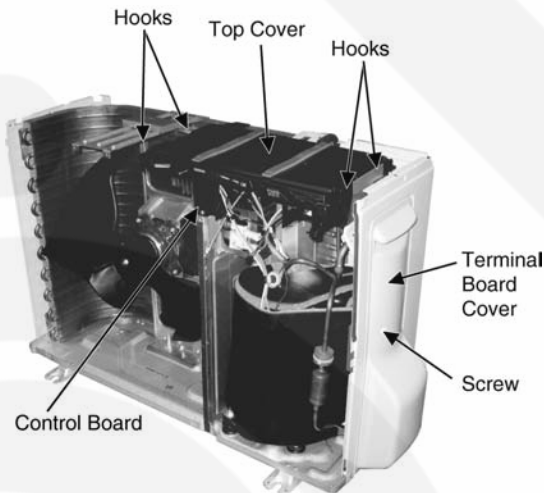

Fig. 15

WARNING

- Be save to return the wiring to its original position
- There are many high voltage components within the heat sink cover so never touch the interior during operation. Wait at least two minutes after power has been turned off.

5. Remove the Control Board as follows:

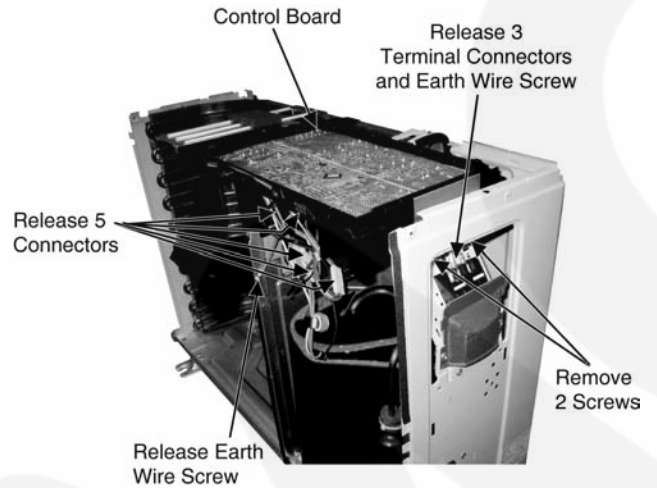

Fig. 16

Remove the Terminal Cover and 3 Terminal Compressor

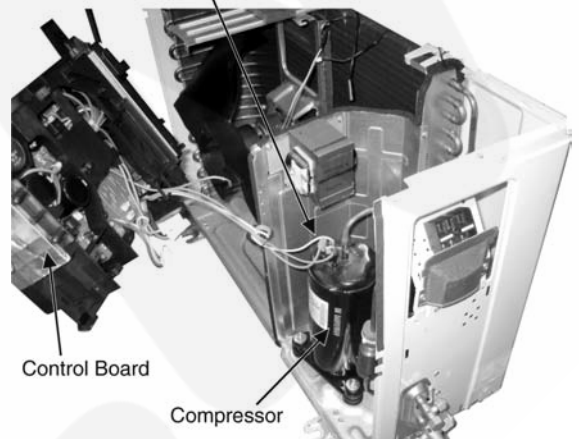

Fig. 17

Electronic Controller

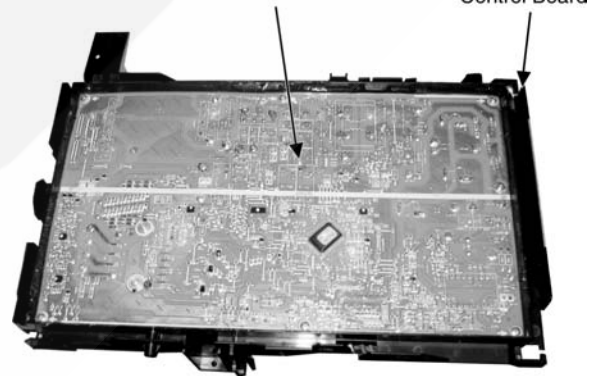

Fig. 18

8.1.2. CU-E18GFE-2

1. Remove the 4 screws of the Top Panel.

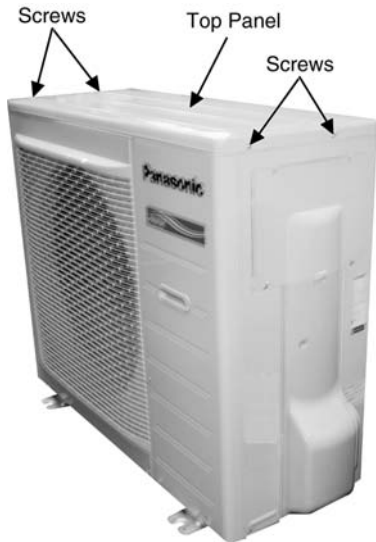

Fig. 19

2. Remove the 10 screws of the Front Panel.

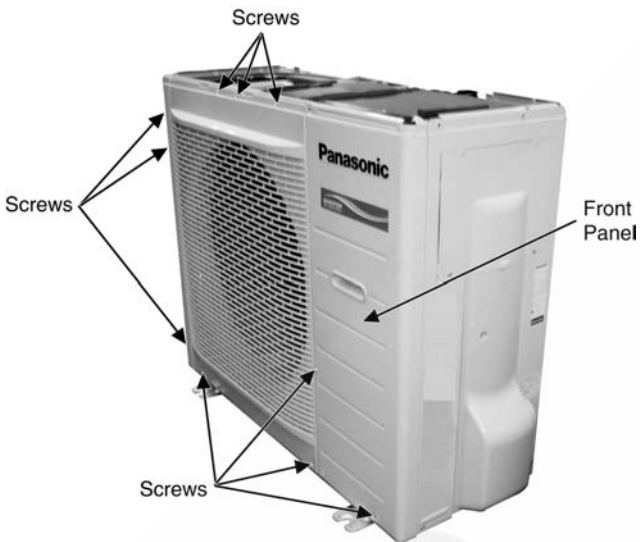



Fig. 20

3. Remove the Top Cover of the Electronic Controller.



Fig. 21

 **WARNING**

- Be save to return the wiring to its original position
- There are many high voltage components within the heat sink cover so never touch the interior during operation. Wait at least two minutes after power has been turned off.

4. Remove the Control Board.

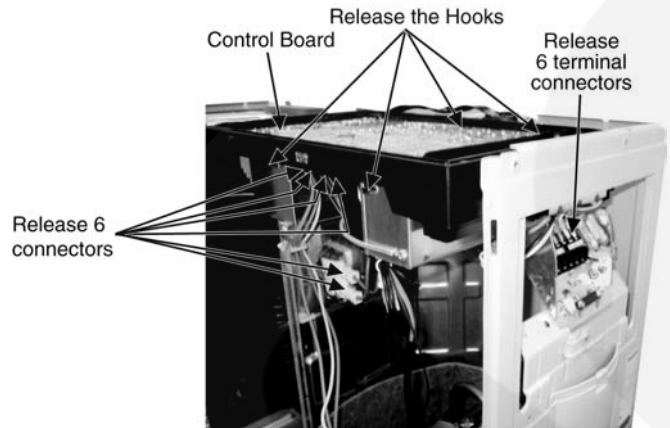

Fig. 22

5. Remove the 8 screws of the Electronic Controller.

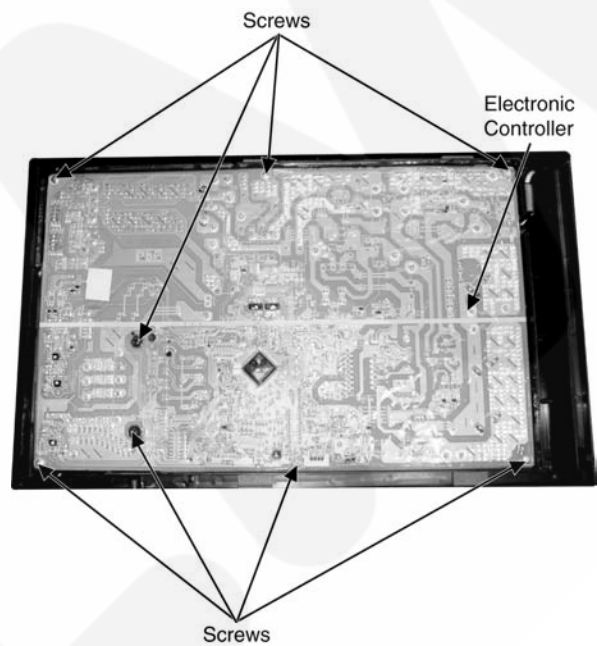

Fig. 23

9 Technical Data

9.1. Operation Characteristics

CS-E9GFEW-2 CU-E9GFE-2

• Cooling Characteristic

[Condition] Room temperature: 27/19°C
 Cooling operation: At High Fan
 Rated Frequency Operation

◇ 220V
 ◆ 230V
 △ 240V

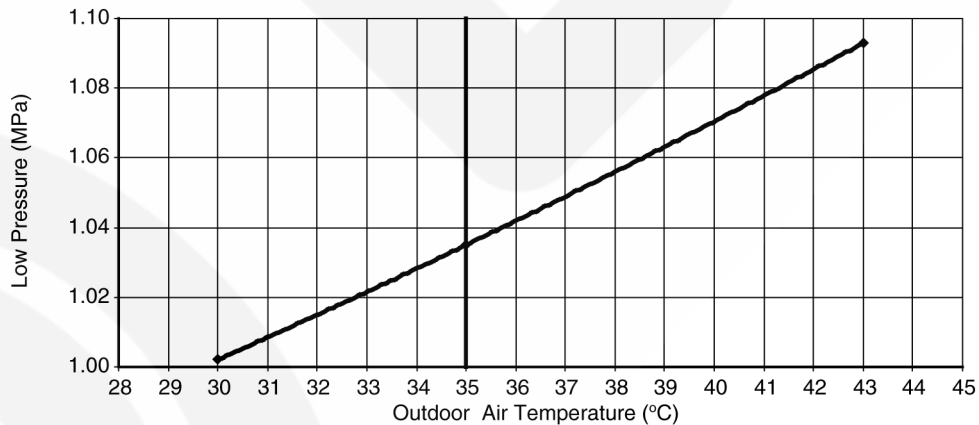
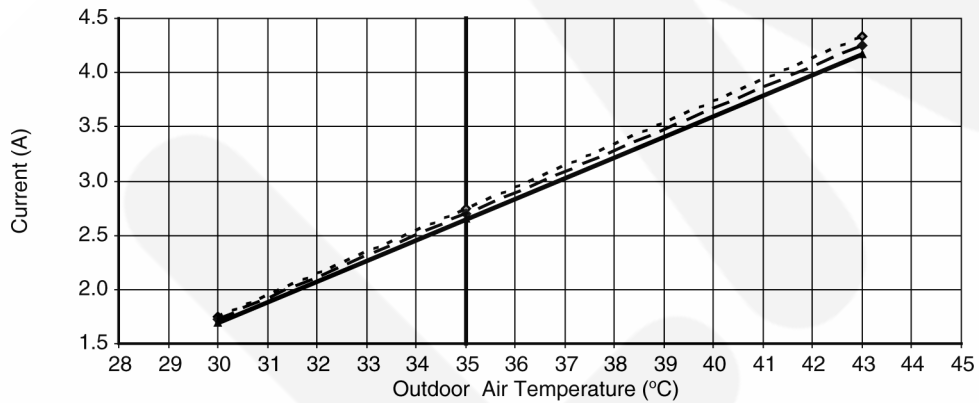
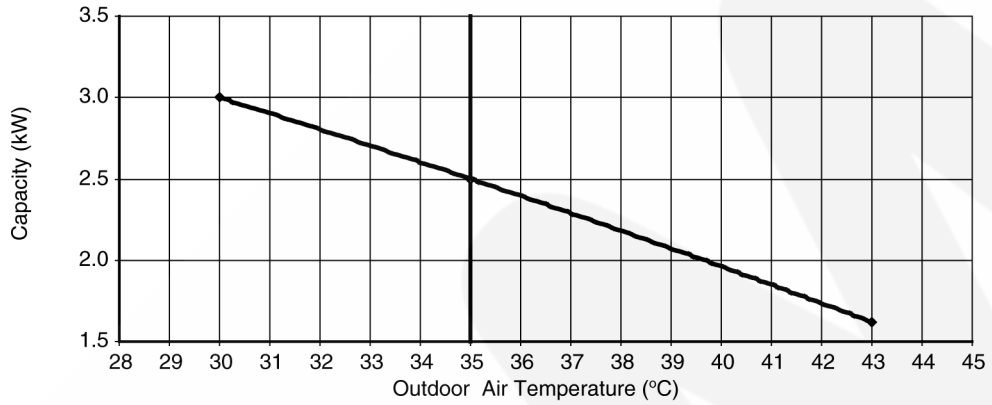
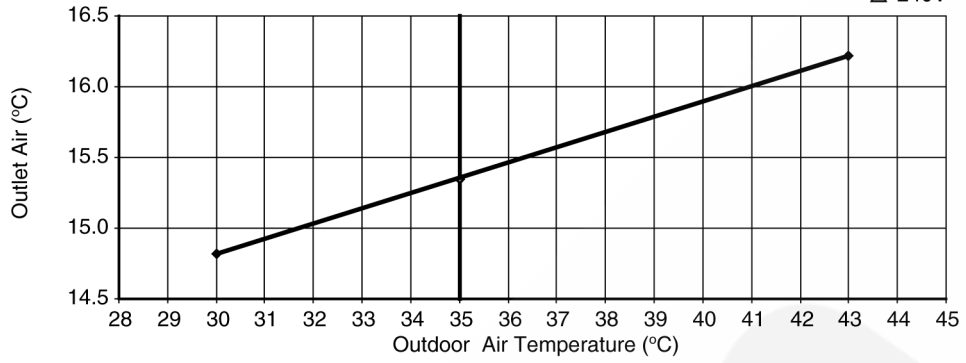

• Piping Length Characteristic

[Condition] Room temperature: 27/19°C
 Cooling operation: At High fan
 Rated Frequency Operation

▲ 220V
 ◆ 230V
 ■ 240V

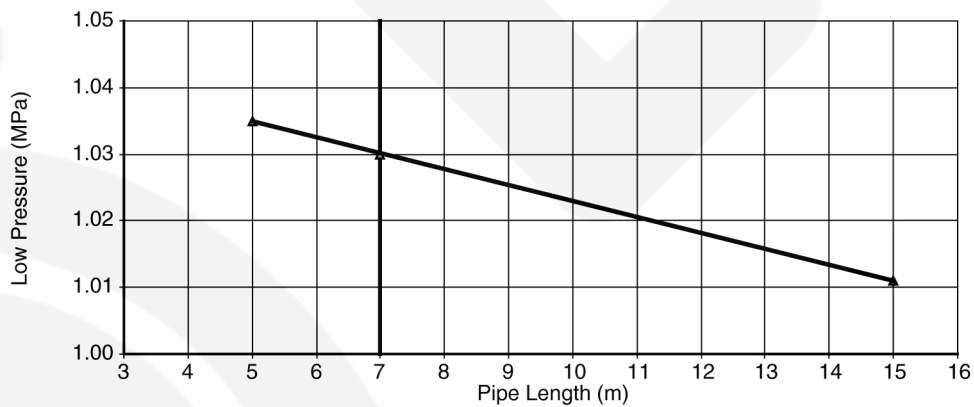
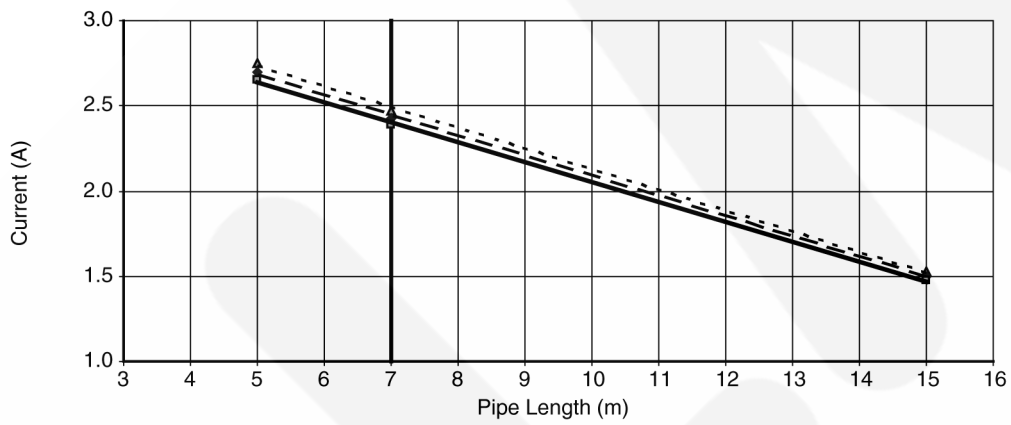
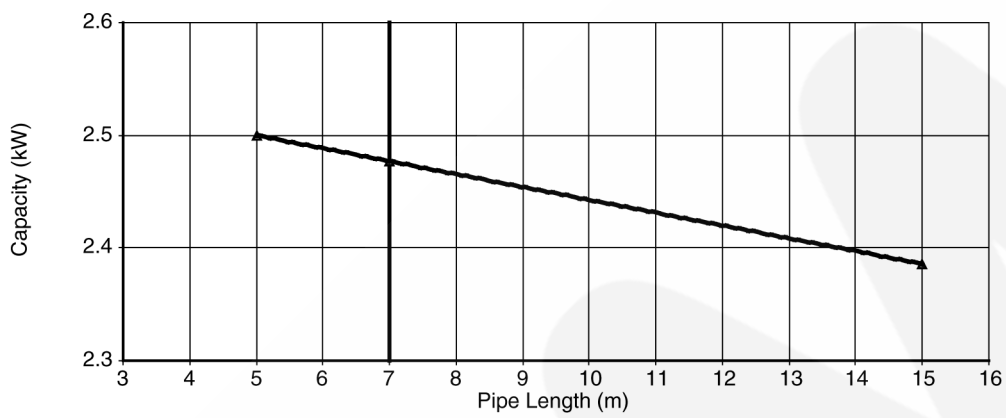
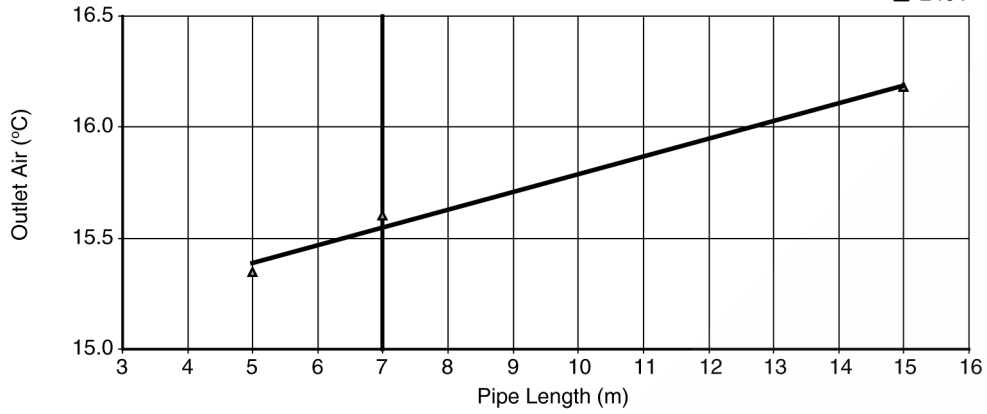

• Heating Characteristic

[Condition] Room temperature: 20°C
 Heating operation: At High Fan
 Rated Frequency Operation

▲ 220V
 ◆ 230V
 ■ 240V

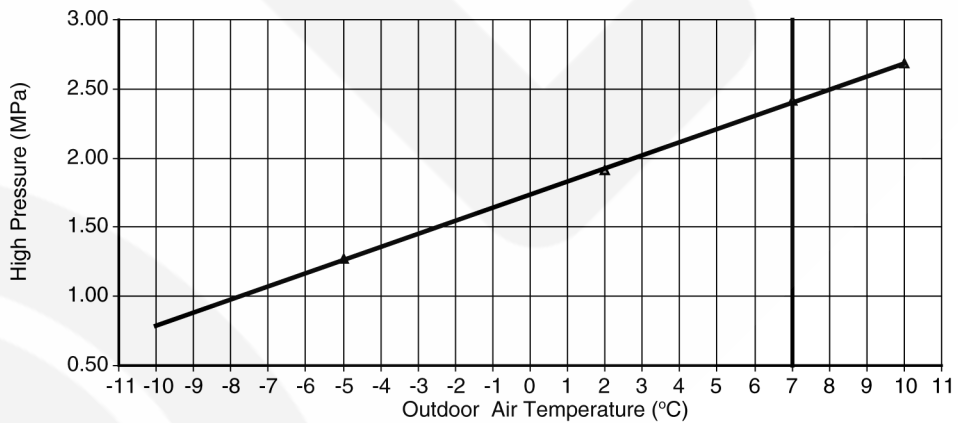
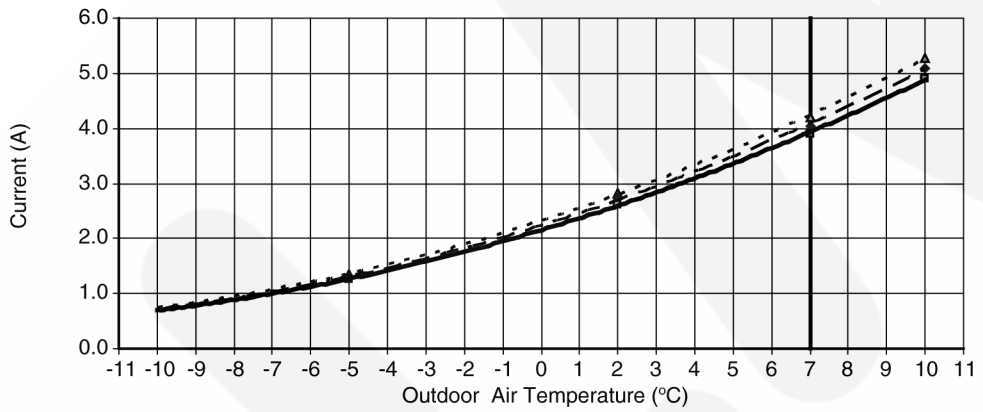
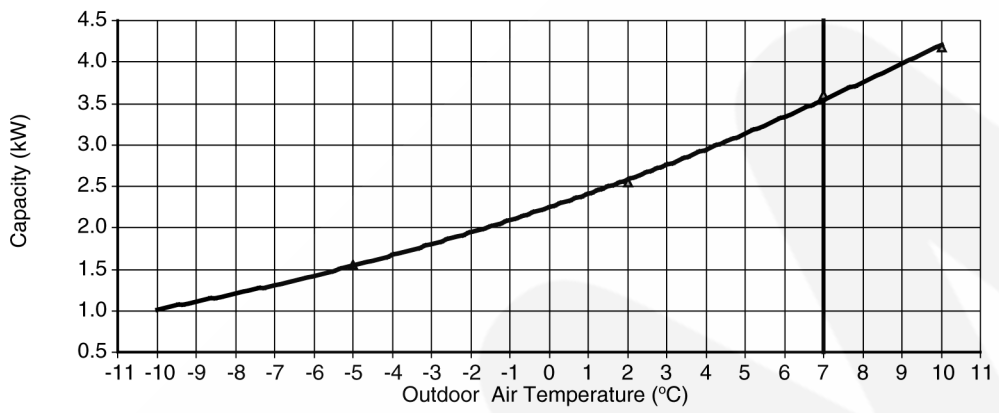
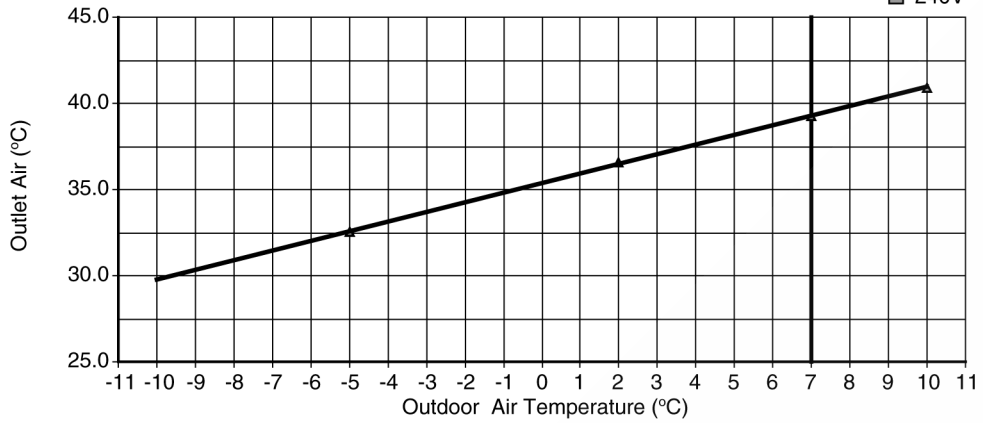

• Piping Length Characteristic

[Condition] Room temperature: 20°C
 Heating operation: 7/6°C
 Rated Frequency Operation

▲ 220V
 ◆ 230V
 ■ 240V

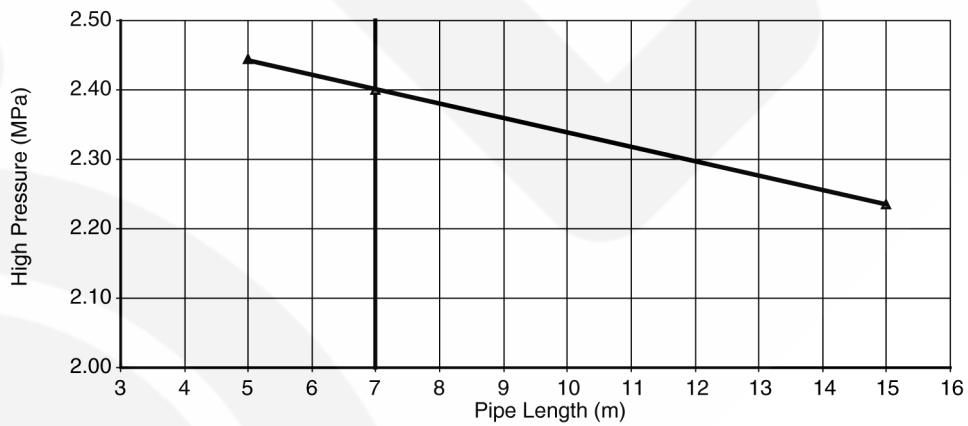
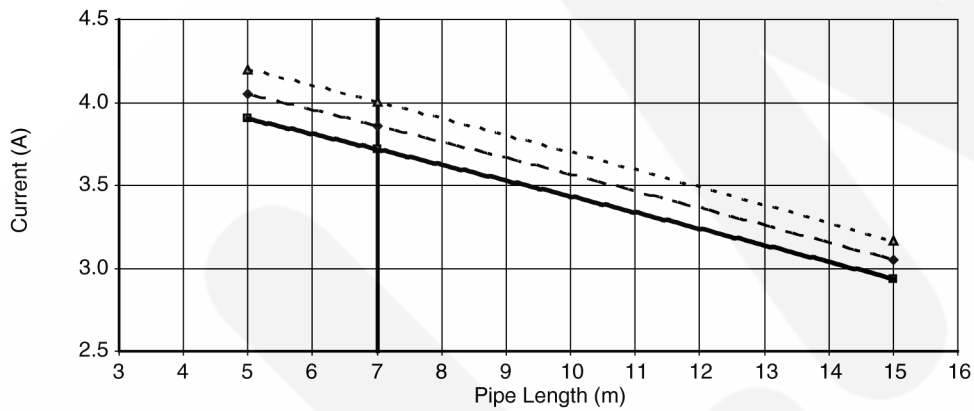
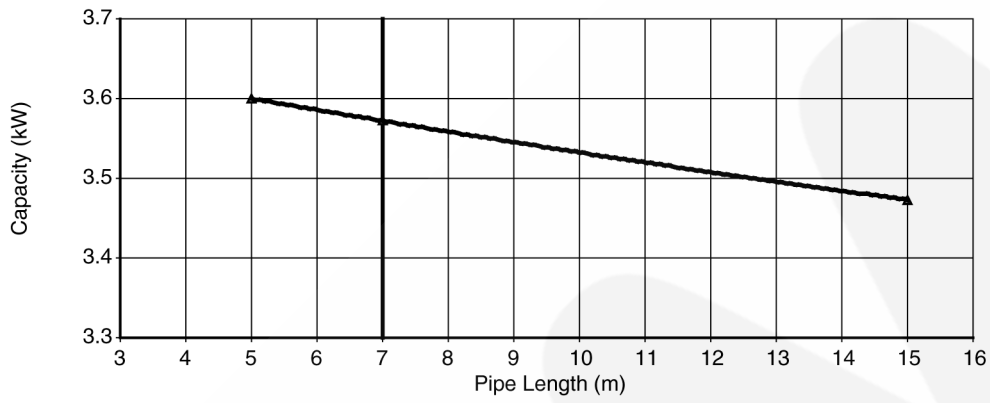
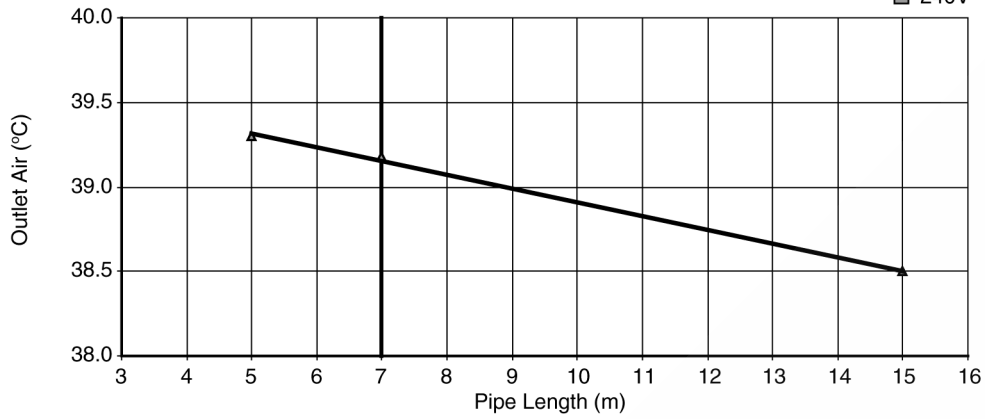

CS-E12GFEW-2 CU-E12GFE-2

• Cooling Characteristic

[Condition] Room temperature: 27/19°C
 Cooling operation: At High Fan
 Rated Frequency Operation

◇ 220V
 ◆ 230V
 △ 240V

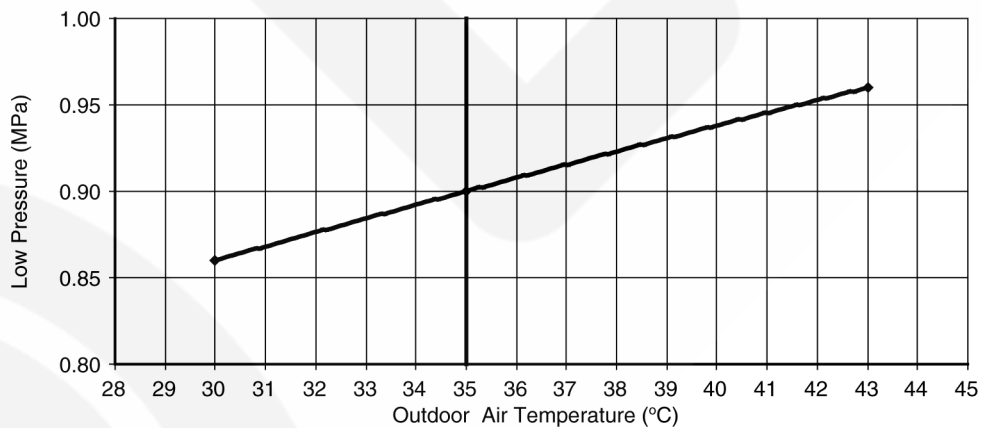
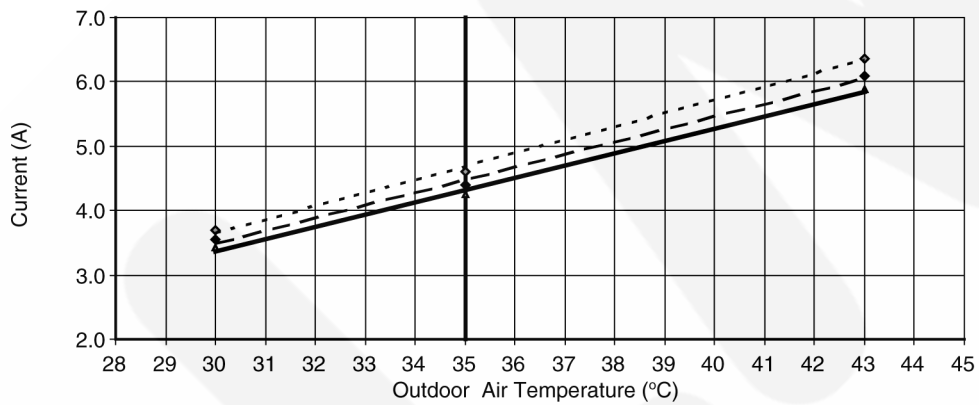
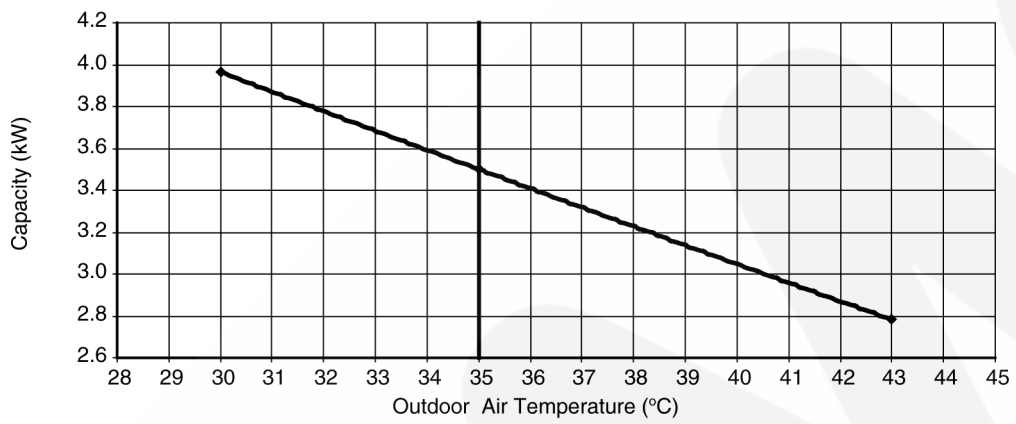
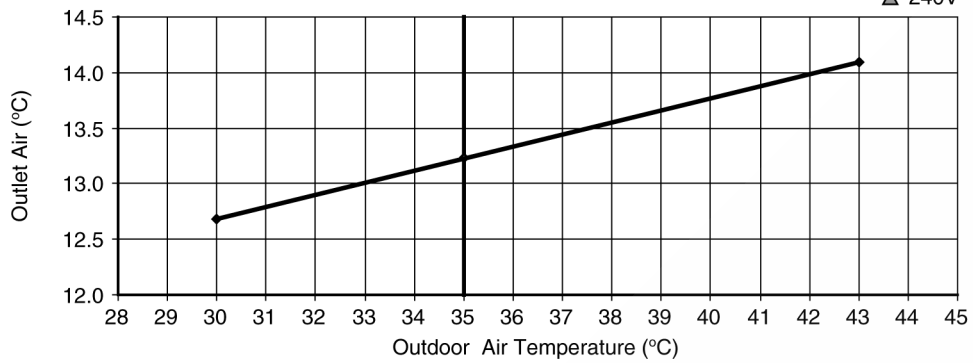

• Piping Length Characteristic

[Condition] Room temperature: 27/19°C
 Cooling operation: At High fan
 Rated Frequency Operation

▲ 220V
 ◆ 230V
 ■ 240V

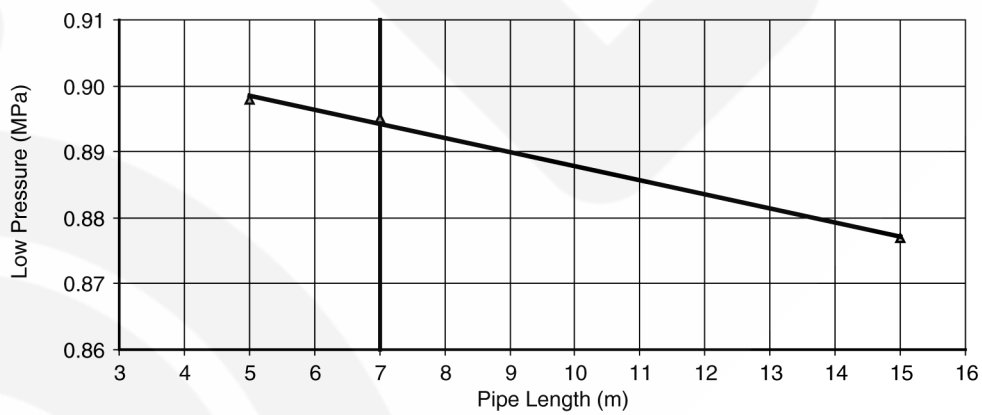
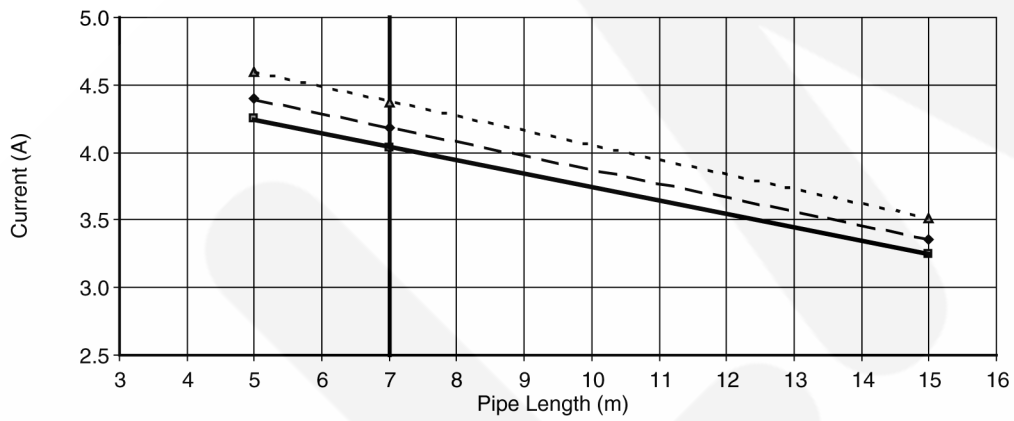
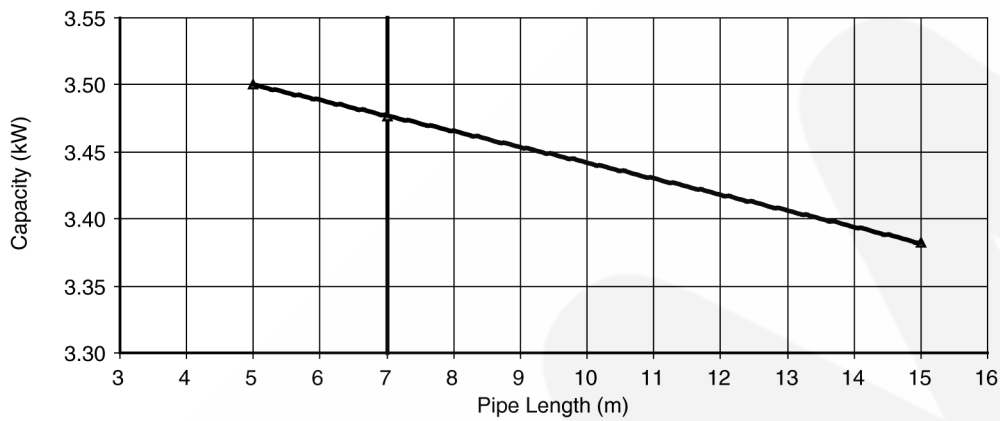
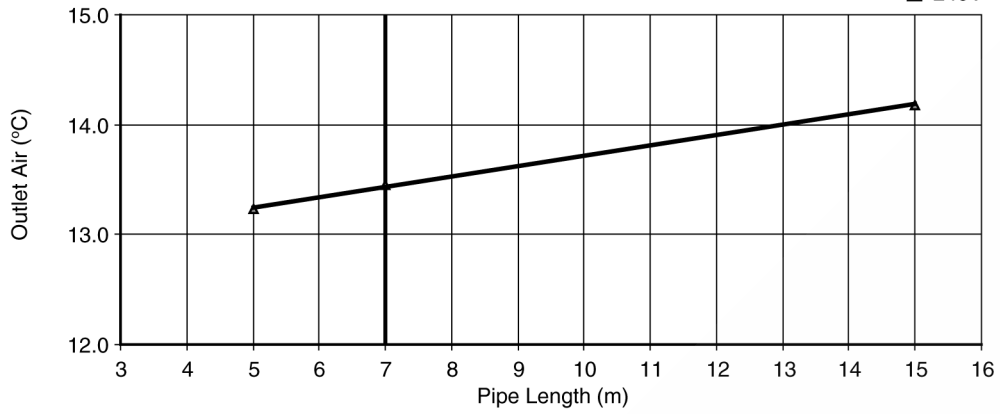

• Heating Characteristic

[Condition] Room temperature: 20°C
 Heating operation: At High Fan
 Rated Frequency Operation

▲ 220V
 ◆ 230V
 ■ 240V

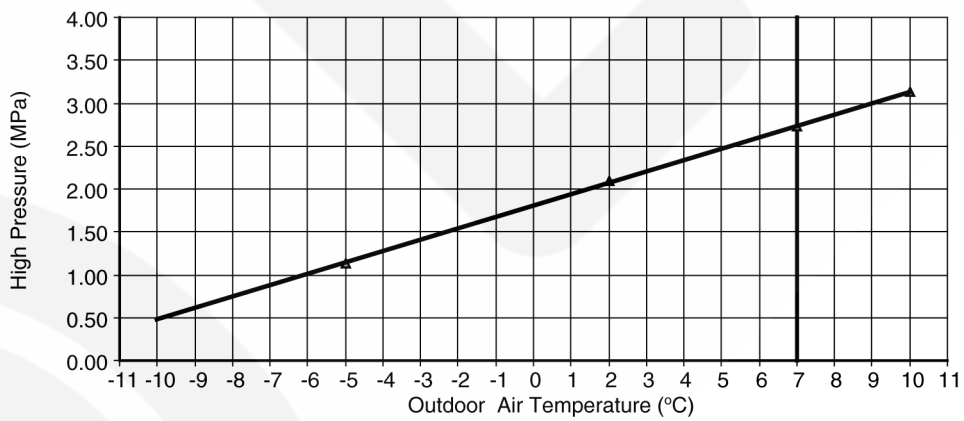
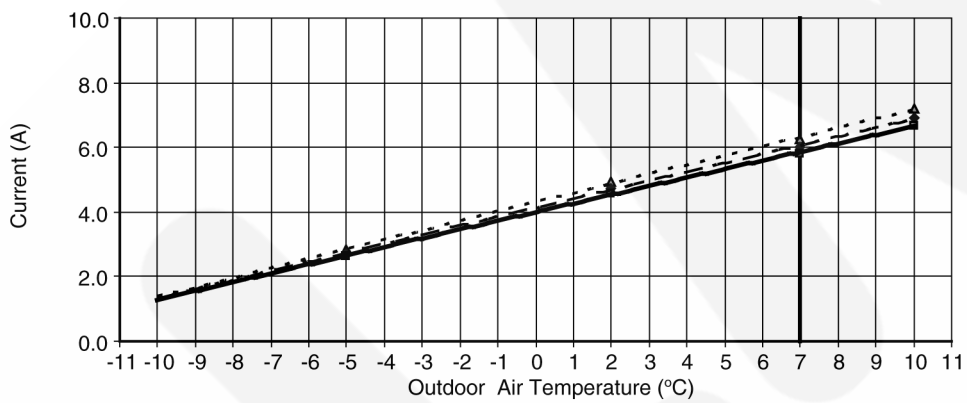
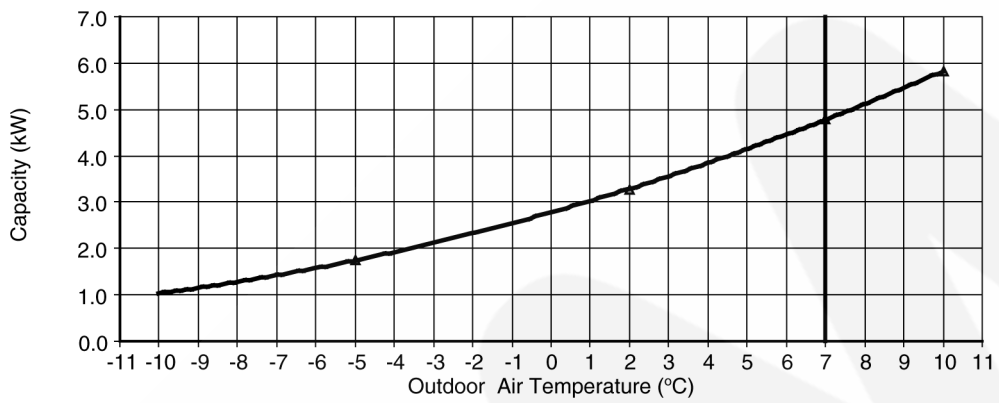
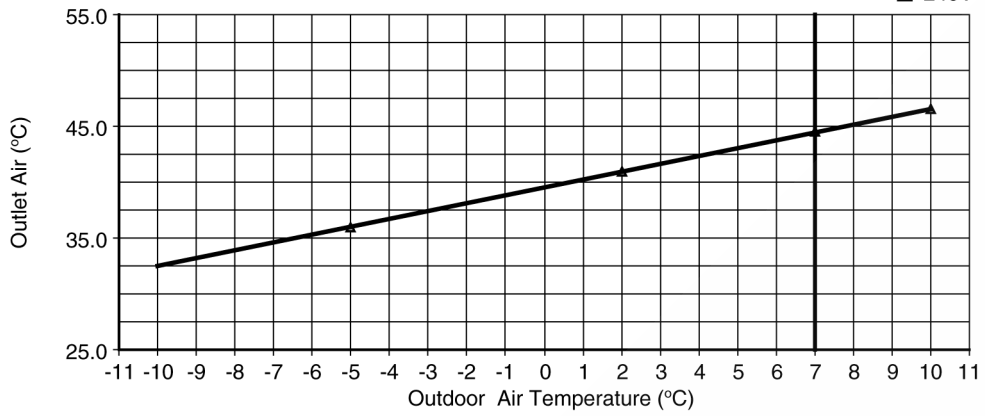

• Piping Length Characteristic

[Condition] Room temperature: 20°C
 Heating operation: 7/6°C
 Rated Frequency Operation

▲ 220V
 ◆ 230V
 ■ 240V

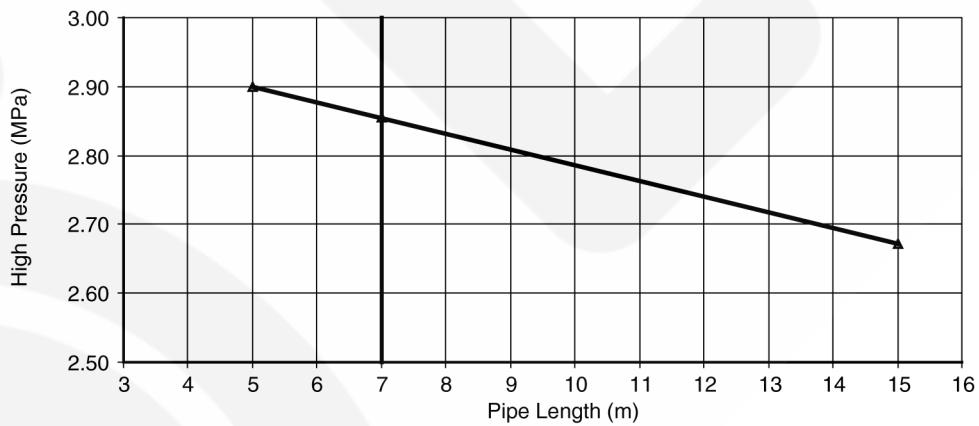
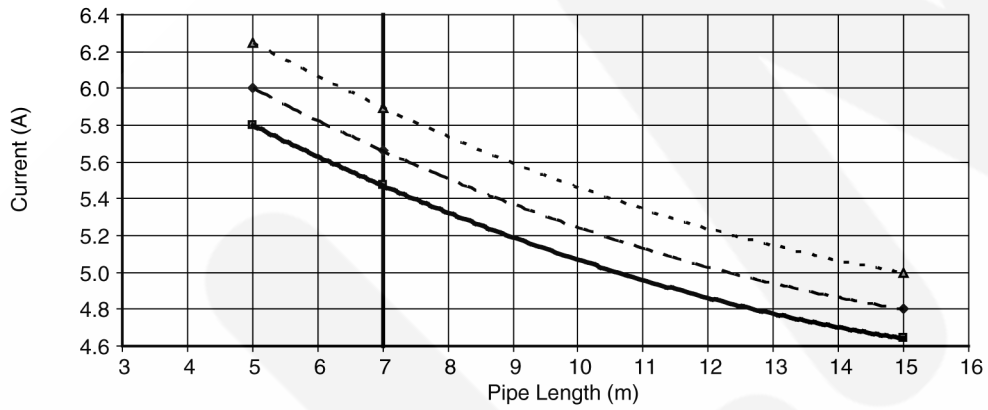
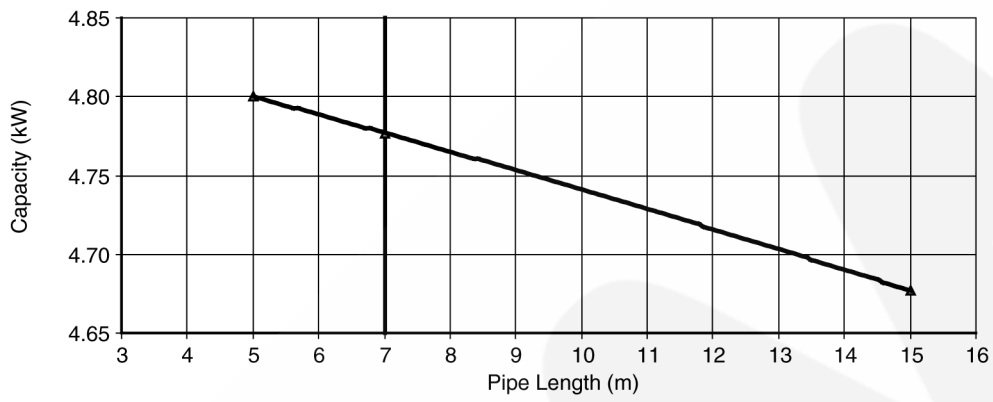
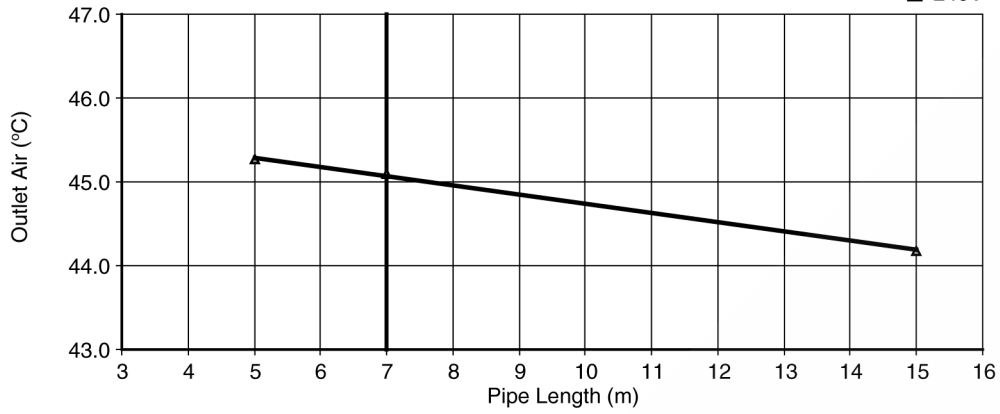

CS-E18GFEW-2 CU-E18GFE-2

• Cooling Characteristic

[Condition] Room temperature: 27/19°C
 Cooling operation: At High Fan
 Rated Frequency Operation

◇ 220V
 ◆ 230V
 △ 240V

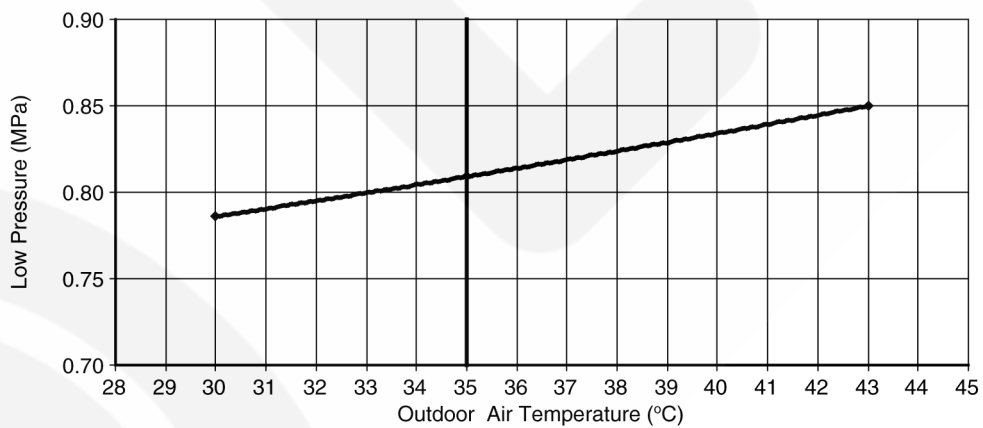
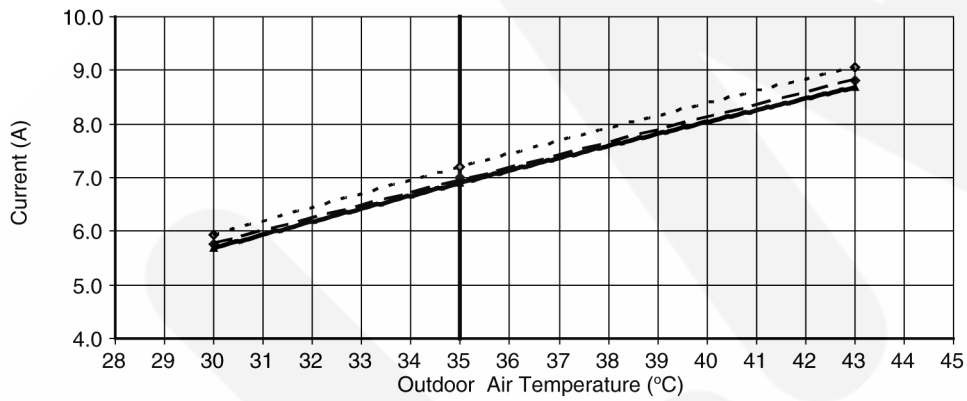
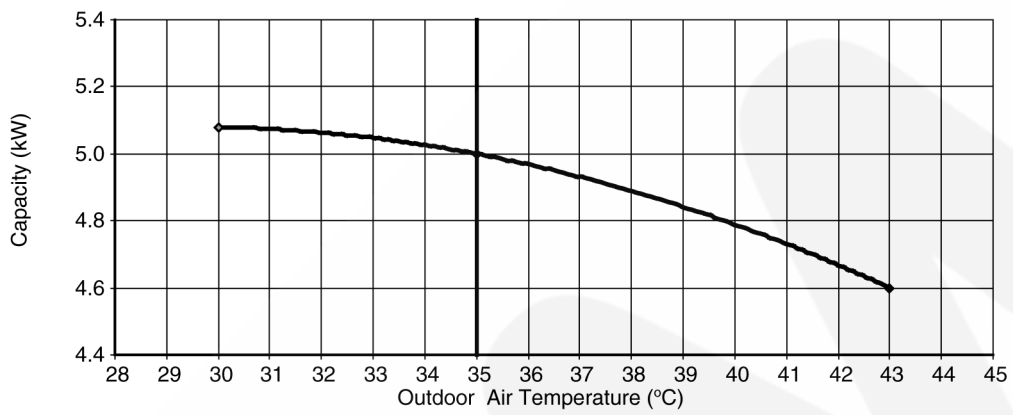
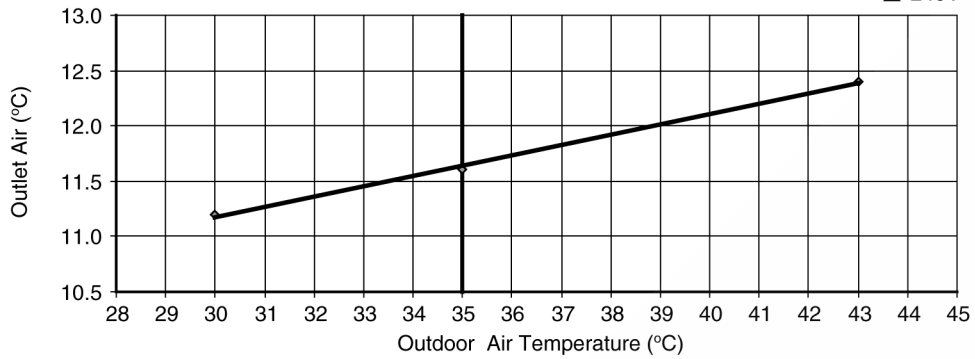

• Piping Length Characteristic

[Condition] Room temperature: 27/19°C
 Cooling operation: At High fan
 Rated Frequency Operation

▲ 220V
 ◆ 230V
 ■ 240V

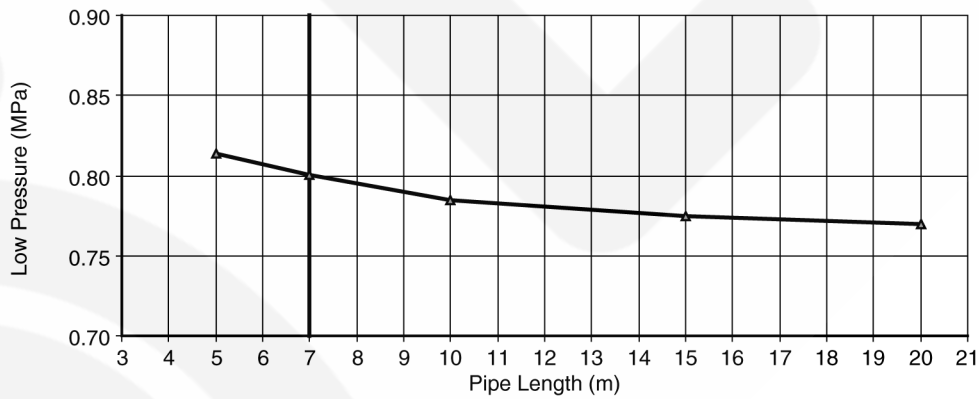
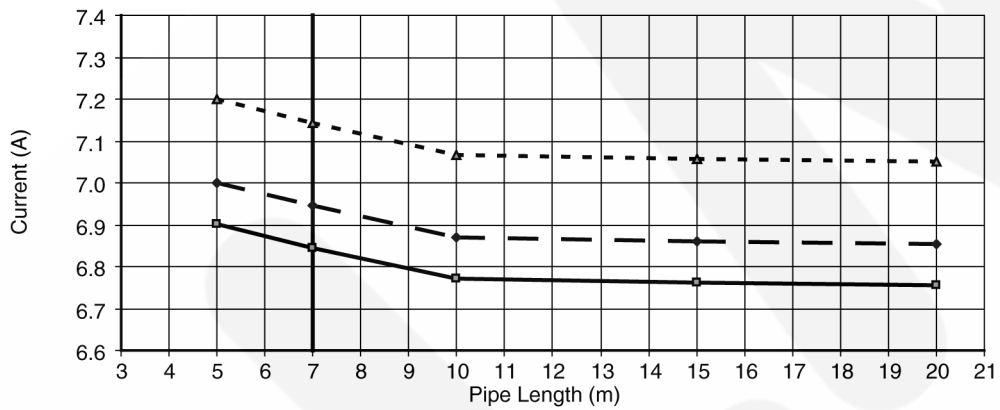
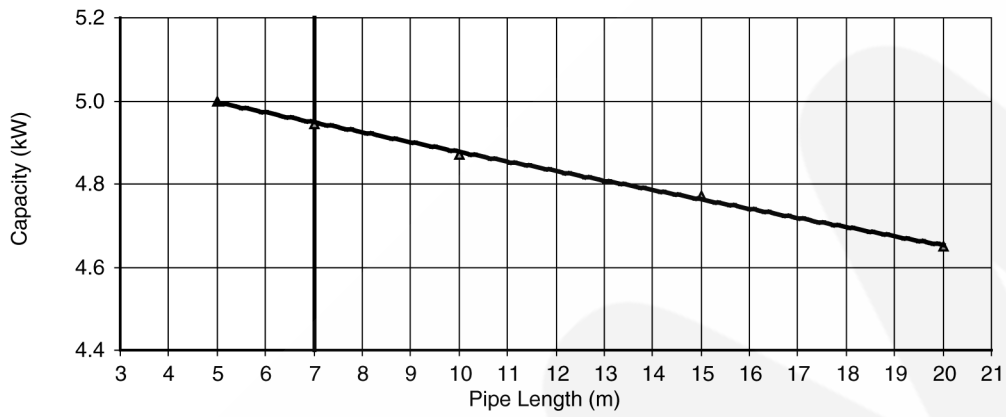
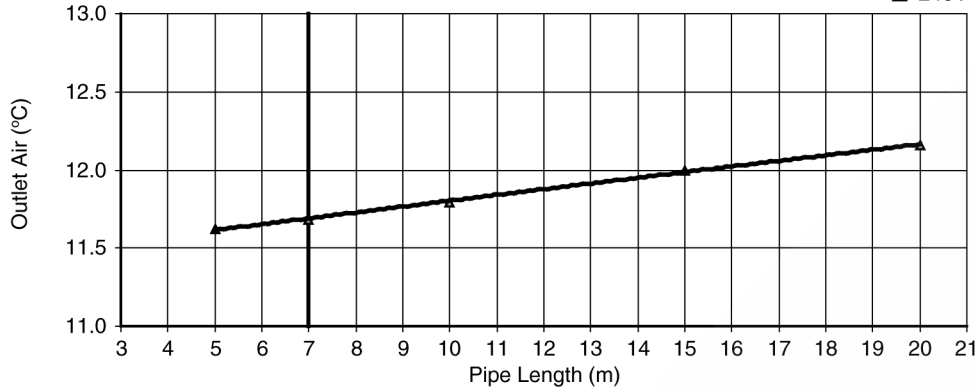

• Heating Characteristic

[Condition] Room temperature: 20°C
 Heating operation: At High Fan
 Rated Frequency Operation

▲ 220V
 ◆ 230V
 ■ 240V

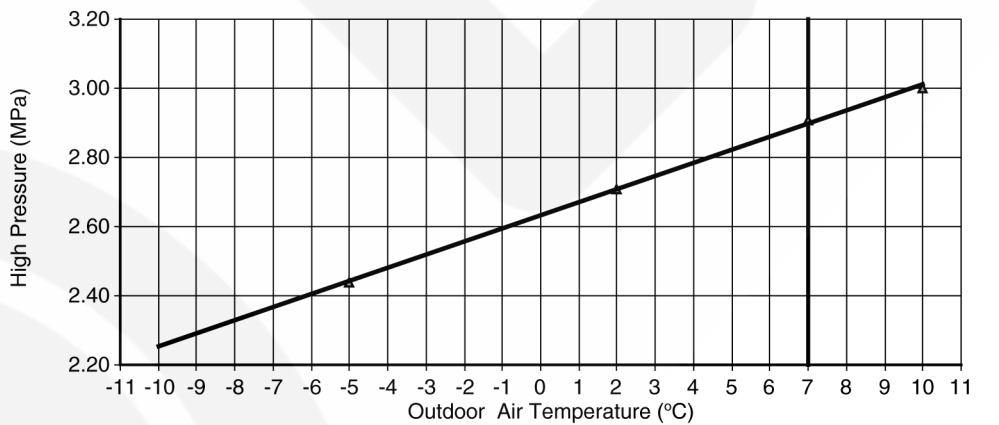
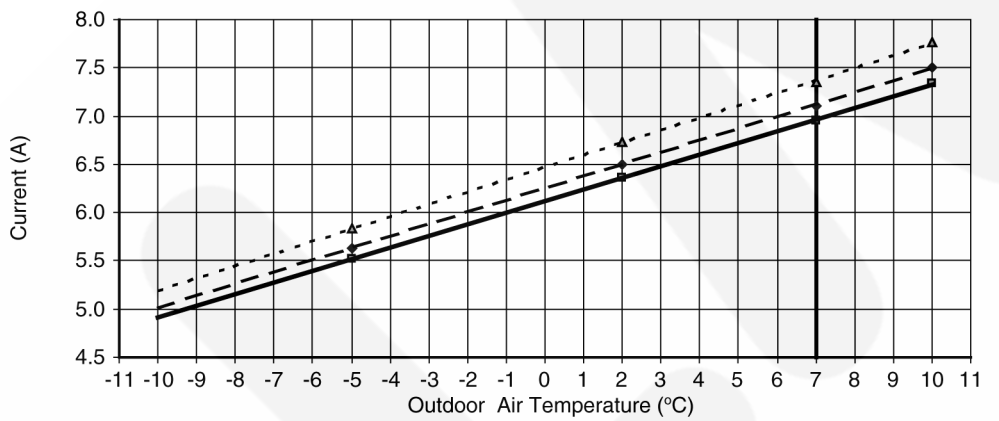
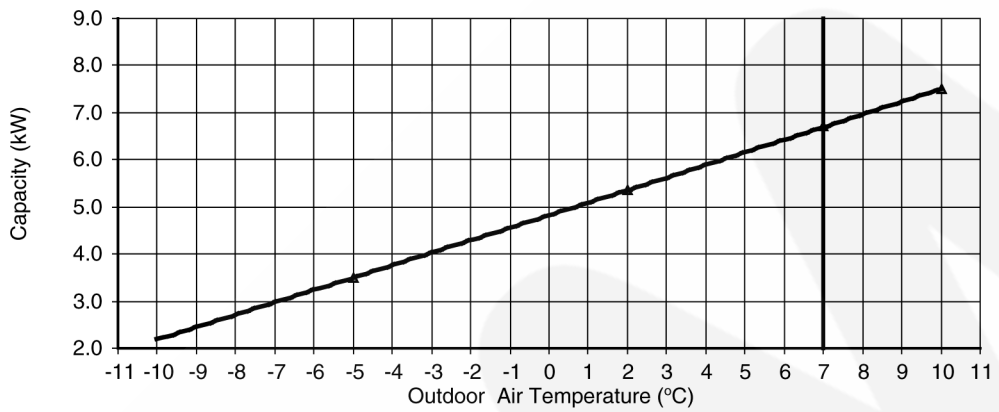
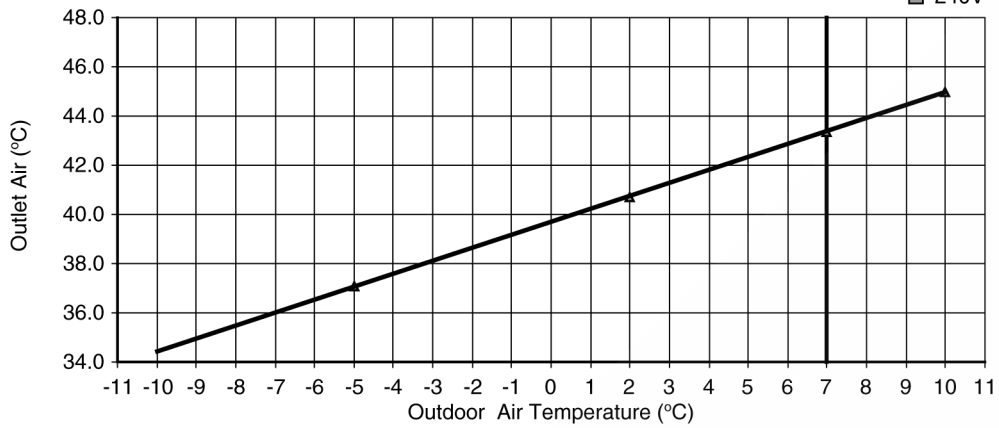

• Piping Length Characteristic

[Condition] Room temperature: 20°C
 Heating operation: 7/6°C
 Rated Frequency Operation

▲ 220V
 ◆ 230V
 ■ 240V

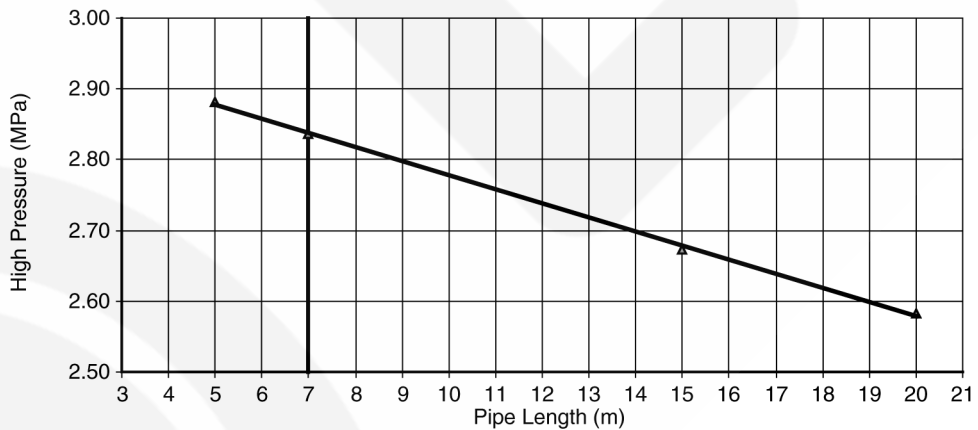
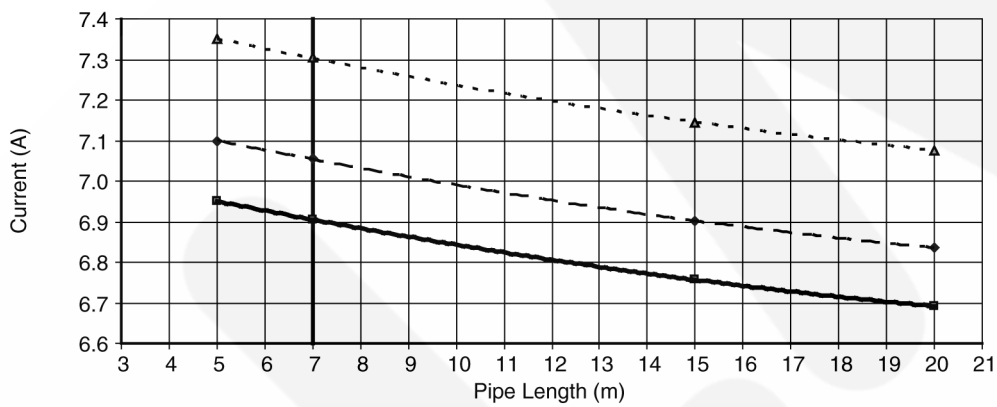
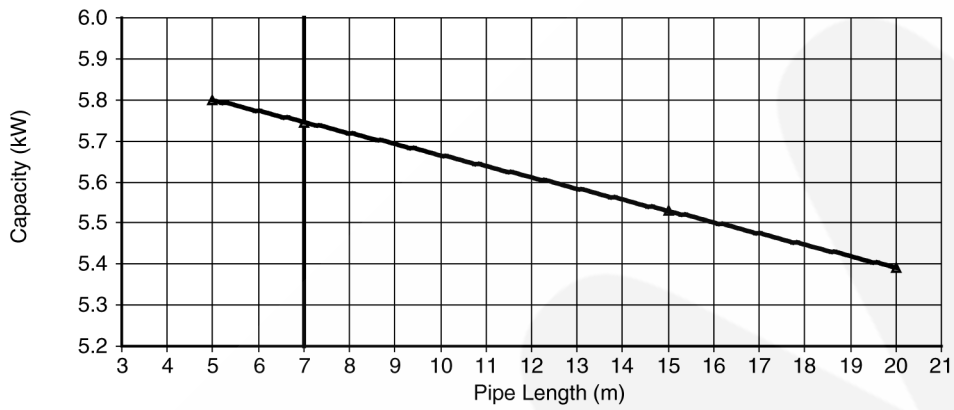
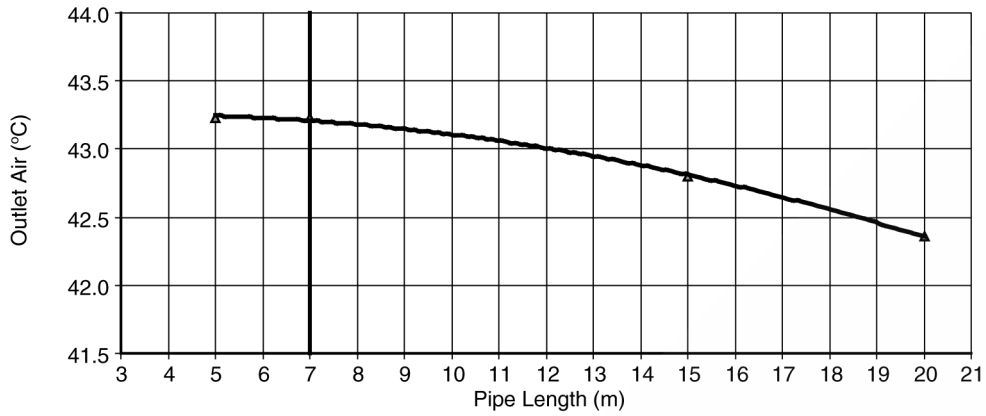

9.2. Sensible Capacity Chart

● CS-E9GFEW-2 CU-E9GFE-2

220V 230V 240V		Outdoor Temp. (°C)											
		30°C			35°C			40°C			46°C		
		TC	SHC	IP	TC	SHC	IP	TC	SHC	IP	TC	SHC	IP
D.B.	W.B.	kW	kW	kW	kW	kW	kW	kW	kW	kW	kW	kW	kW
27	17.0	2.48	2.13	0.52	2.32	2.05	0.56	2.16	1.97	0.60	1.96	1.88	0.65
	19.0				2.50		0.57						
	19.5	2.72	2.23	0.53	2.55	2.15	0.57	2.37	2.06	0.61	2.15	1.97	0.66
	22.0	2.96	2.31	0.54	2.77	2.22	0.58	2.58	2.13	0.62	2.34	2.03	0.67

● CS-E12GFEW-2 CU-E12GFE-2

220V 230V 240V		Outdoor Temp. (°C)											
		30°C			35°C			40°C			46°C		
		TC	SHC	IP	TC	SHC	IP	TC	SHC	IP	TC	SHC	IP
D.B.	W.B.	kW	kW	kW	kW	kW	kW	kW	kW	kW	kW	kW	kW
27	17.0	3.47	2.49	0.89	3.25	2.40	0.96	3.02	2.30	1.03	2.74	2.20	1.11
	19.0				3.50		0.97						
	19.5	3.81	2.61	0.90	3.57	2.51	0.97	3.32	2.41	1.04	3.02	2.30	1.12
	22.0	4.15	2.70	0.92	3.88	2.60	0.98	3.61	2.49	1.06	3.28	2.38	1.14

● CS-E18GFEW-2 CU-E18GFE-2

220V 230V 240V		Outdoor Temp. (°C)											
		30°C			35°C			40°C			46°C		
		TC	SHC	IP	TC	SHC	IP	TC	SHC	IP	TC	SHC	IP
D.B.	W.B.	kW	kW	kW	kW	kW	kW	kW	kW	kW	kW	kW	kW
27	17.0	4.96	3.26	1.44	4.64	3.14	1.54	4.32	3.01	1.65	3.92	2.87	1.78
	19.0				5.00		1.56						
	19.5	5.45	3.41	1.45	5.10	3.28	1.56	4.74	3.15	1.67	4.31	3.01	1.80
	22.0	5.92	3.53	1.47	5.55	3.40	1.58	5.16	3.26	1.70	4.69	3.11	1.83

TC - Total Cooling Capacity (kW)
 SHC - Sensible Heat Capacity (kW)
 IP - Input Power (kW)

Indoor 27°C/19°C
 Outdoor 35°C/24°C

REF. NO.	PART NAME AND DESCRIPTION	QTY.	CS-E9GFEW-2	CS-E12GFEW-2	CS-E18GFEW-2	REMARKS
B1	EVAPORATOR ASS'Y	1	CW1786554	←	CW1800652	
B1-7	FLARE NUT	1	CW1723546	←	←	
B2	FITTING SPRING / THERMISTOR	1	CW380120	←	←	
B3	GROUNDING TIP (W/WASHER)	1	CW113783J	←	←	
B5	FLARE NUT	1	CW119848J	←	CW119849J	
C1	TURBO FAN ASS'Y	1	CW1767414	←	←	
C2	AIR GUIDE PLATE ASS'Y	1	CW1767421	←	←	
C2-6	STEPPING MOTOR	1	CW151065J	←	←	O
C2-9	WIRE HARNESS ASS'Y (UPPER)	1	CW1767546	←	←	
C3	DRAIN PAN ASS'Y	1	CW1767553	←	←	
C3-4	STEPPING MOTOR ASS'Y	1	CW1767591	←	←	
C3-5	SLEEVE BEARING	1	CW1767609	←	←	
C3-6	SHAFT (DAMPER)	1	CW1767616	←	←	
C3-7	WIRE HARNESS ASS'Y (LOWER)	1	CW1767623	←	←	
C4	LOCK NUT/ FAN BLADE	1	CW847002J	←	←	
C5	AIR FILTER	1	CW1767647	←	←	
E1	SWITCH BOX	1	CW1767654	←	←	
E2	INDICATION LAMP COVER	1	CW1786561	←	←	
E3	MOUNTING PLATE, PRINTED CIRCUIT	1	CW1767678	←	←	
E4	SHIELD PLATE	1	CW1767685	←	←	
E5	SHIELD PLATE	1	CW1767692	←	←	
E6	SHIELD PLATE	1	CW1767700	←	←	
E7	SWITCH KNOB	1	CW0728803	←	←	
E8	PRINTED CIRCUIT ASS'Y (CONTROL)	1	CW1786617	CW1786624	CW1786631	O
E8-1	FUSE	1	CW153875J	←	←	
E8-3	THERMISTOR (FOR COIL)	1	CW129970J	←	←	
E9	WIRE HARNESS ASS'Y	1	CW1786648	←	←	
E10	PRINTED CIRCUIT ASS'Y (SERVICE)	1	CW1786794	←	←	
E11	TERMINAL BLOCK	1	CW1786662	←	←	
E12	WIRE CLAMP	1	CW0812847	←	←	
E13	PRINTED CIRCUIT ASS'Y (DISPLAY)	1	CW1786655	←	←	
E14	PRINTED CIRCUIT ASS'Y (SENSOR)	1	CW1767755	←	←	
E15	EARTH WIRE	1	CW1786679	←	←	
E17	SHIELD PLATE ASS'Y	1	CW1767786	←	←	
E17-1	INSULATION SHEET	1	CW1767793	←	←	
E18	DC FAN MOTOR	1	CW1889408	←	←	O
E19	PAN HEAD TAPPING SCREW	2	CW111403J	←	←	
E20	EARTH PLATE	1	CW1786686	←	←	
E21	WASHER (FOR EARTH)	2	CW1786749	←	←	
F1	BOTTOM FRAME ASS'Y	1	CW1767818	←	←	
F1-3	THERMAL INSULATION ASS'Y	1	CW1786756	←	←	
F1-4	THERMAL INSULATION ASS'Y	1	CW1786763	←	←	
F2	BELL MOUTH ASS'Y	1	CW1767849	←	←	
F3	COVER, MOTOR	1	CW1767856	←	←	
F4	FRONT GRILLE ASS'Y	1	CW1767863	←	←	
F5	CONTROL PANEL ASS'Y	1	CW1786693	←	←	
F6	SUCTION GRILLE ASS'Y	1	CW1786718	←	←	
F6-1	KNOB (1)	2	CW1767933	←	←	
F6-2	KNOB (2)	1	CW1768013	←	←	
F6-3	KNOB (2)	1	CW1768020	←	←	
F6-4	STRING	1	CW1768037	←	←	
F7	WIRE CLAMP	1	CW1768044	←	←	
F8	CASING (UPPER)	1	CW1814790	←	←	
F9	CASING (RIGHT)	1	CW1768068	←	←	

REF. NO.	PART NAME AND DESCRIPTION	QTY.	CS-E9GFEW-2	CS-E12GFEW-2	CS-E18GFEW-2	REMARKS
F10	CASING (LEFT)	1	CW1768075	←	←	
F11	FIXTURE, REF. PIPING	1	CW1768082	←	←	
F12	REINFORCE PLATE ASS'Y	1	CW1768099	←	←	
F13	THERMAL INSULATION ASS'Y	1	CW1768107	←	←	
K1	REMOTE CONTROL	1	CWA75C3096	←	←	O
K3	INSTALLATION PLATE	1	CW1768121	←	←	
K4	SCREW KIT	1	CW1786965	←	←	
K6	DRAIN HOSE ASS'Y	1	CW1768138	←	←	
K13	TAPE	1	CW1786871	←	←	
51	OPERATING INSTRUCTIONS	1	CWF566395	←	←	
52	INSTALLATION INSTRUCTIONS	1	CWF613483	←	←	
53	INSTALLATION INSTRUCTIONS	1	CWF613484	←	←	

(Note)

- All parts are supplied from ACBU, Japan.
- "O" marked parts are recommended to be kept in stock.

REF. NO.	PART NAME AND DESCRIPTION	QTY.	CU-E9GFE-2	CU-E12GFE-2	REMARK
1	CHASSY ASSY	1	CWD50K2073	←	
2	ANTI - VIBRATION BUSHING	3	CWH50077	←	
3	COMPRESSOR	1	5RS102XBC01	←	O
4	NUT - COMPRESSOR MOUNT	3	CWH56000J	←	
5	SOUND PROOF MATERIAL	1	CWG302315	←	
6	SOUND PROOF MATERIAL	1	CWG302316	←	
7	FAN MOTOR BRACKET	1	CWD541030	←	
8	FAN MOTOR (AC 30W SINGLE)	1	CWA951553	CWA951542	O
9	SCREW - FAN MOTOR BRACKET	2	CWH551217	←	
10	SCREW - FAN MOTOR MOUNT	3	CWH55252J	←	
11	PROPELLER FAN ASSY	1	CWH03K1010	←	
12	NUT - PROPELLER FAN	1	CWH56053J	←	
13	CONDENSER	1	CWB32C2446	←	
14	TUBE ASSY CO (CAP./CHK.VALVE)	1	CWT01C4201	CWT01C4202	
15	HOLDER-COUPLING	1	CWH351023	←	
16	3 WAYS VALVE (GAS)	1	CWB011374	←	O
17	4 WAYS VALVE	1	CWB001037J	←	O
18	2-WAYS VALVE (LIQUID)	1	CWB021301	←	O
19	V-COIL COMPLETE	1	CWA43C2143J	←	O
20	SOUND PROOF BOARD	1	CWH151172	←	
21	REACTOR	1	G0C193J00003	G0C193J00004	
22	SENSOR COMPLETE	1	CWA50C2205	←	
24	TERMINAL BOARD ASSY	1	CWA28K1110J	←	
25	ELECTRONIC CONTROLLER - MAIN	1	CWA73C3418R	CWA73C3419R	O
29	SENSOR COMPLETE	1	CWA50C2391	←	
30	HOLDER SENSOR	1	CWH321023	←	
31	TERMINAL COVER	1	CWH171039A	←	
32	NUT - TERMINAL COVER	1	CWH7080300J	←	
33	CABINET SIDE PLATE CO.	1	CWE04C1116	←	
34	CABINET SIDE PLATE (L)	1	CWE041248A	←	
35	HANDLE	1	CWE161010	←	
36	WIRE NET	1	CWD041111A	←	
37	CABINET FRONT PLATE CO.	1	CWE06C1136	←	
38	CABINET TOP PLATE	1	CWE031014A	←	
39	CONTROL BOARD COVER (TOP)	1	CWH131264	←	
41	CONTROL BOARD COVER CO.	1	CWH13C1064	←	
42	L-TUBE	1	CWH5850080	←	
43	PACKING - L.TUBE	1	CWB81012	←	
50	DISCHARGE MUFFLER	1	CWB121010	←	
51	CRANKCASE HEATER	1	CWA341044	←	
52	SOUND PROOF MATERIAL	1	CWG302314	←	
53	SOUND PROOF MATERIAL	1	CWG302317	←	

(Note)

- All parts are supplied from PHAAM, Malaysia (Vendor Code: 061).
- "O" maked parts are recommended to be kept in stock.

10.3. CU-E18GFE-2

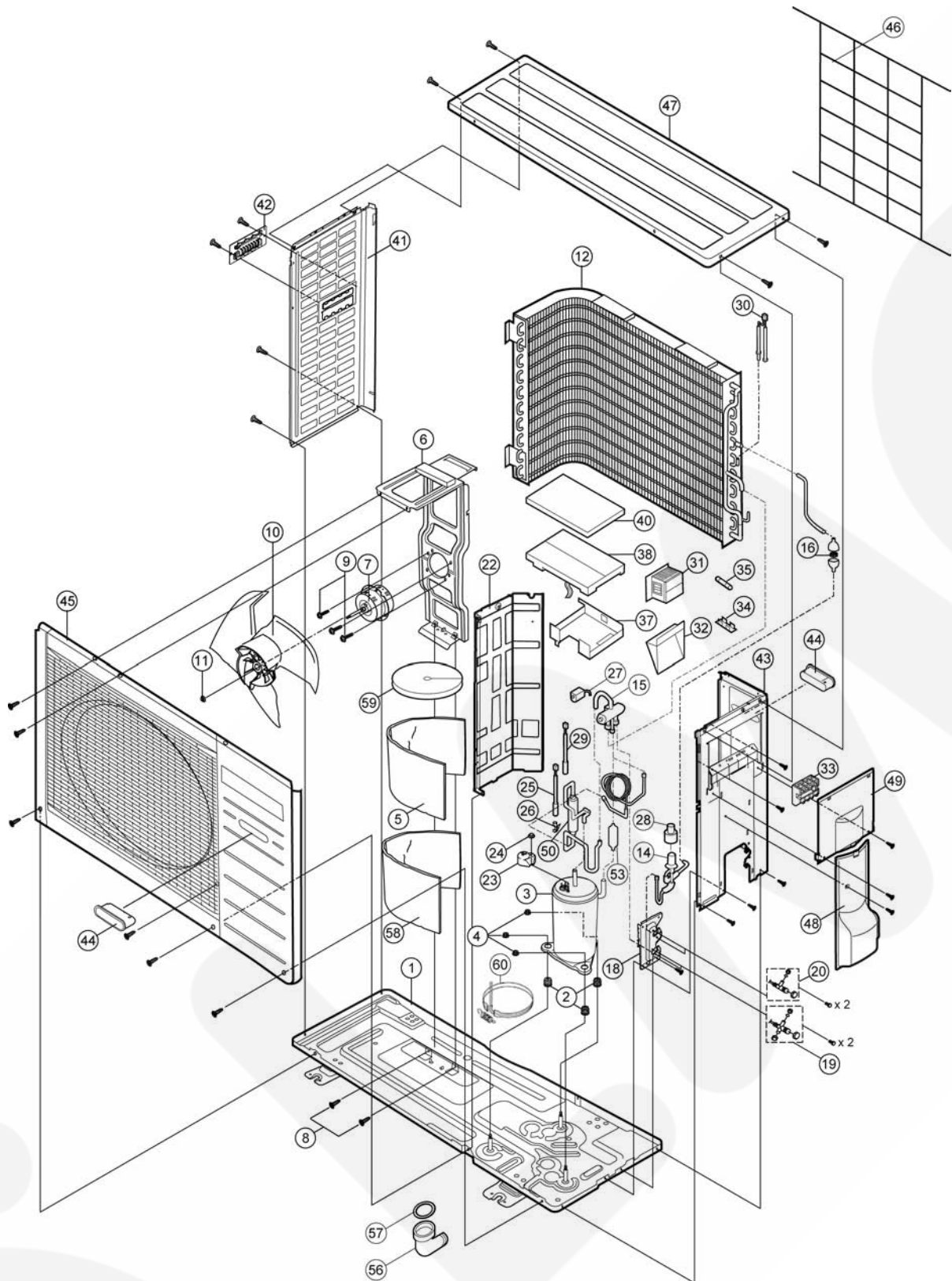

Note:
The above exploded view is for the purpose of parts disassembly and replacement.
The non-numbered parts are not kept as standard service parts.

REF. NO.	PART NAME AND DESCRIPTION	QTY.	CU-E18GFE-2	REMARK
1	CHASSY ASSY	1	CWD50K2085	
2	ANTI - VIBRATION BUSHING	3	CWH50077	
3	COMPRESSOR	1	5CS130XAE04	O
4	NUT - COMPRESSOR MOUNT	3	CWH56000J	
5	SOUND PROOF MATERIAL	1	CWG302302	
6	FAN MOTOR BRACKET	1	CWD541054	
7	FAN MOTOR	1	CWA981166J	O
8	SCREW - FAN MOTOR BRACKET	2	CWH551198	
9	SCREW - FAN MOTOR MOUNT	3	CWH551106J	
10	PROPELLER FAN ASSY	1	CWH03K1016	
11	NUT - PROPELLER FAN	1	CWH56053J	
12	CONDENSER COMPLETE	1	CWB32C2451	
14	TUBE ASSY COMPLETE (EXP. VALVE)	1	CWT023679	
15	4 WAYS VALVE	1	CWB001026J	O
16	STRAINER	1	CWB11094	
18	HOLDER - COUPLING	1	CWH351056	
19	3 WAYS VALVE (GAS)	1	CWB011361	O
20	2-WAYS VALVE (LIQUID)	1	CWB021292	O
22	SOUND PROOF BOARD	1	CWH151050	
23	TERMINAL COVER	1	CWH171039A	
24	NUT - TERMINAL COVER	1	CWH7080300J	
25	SENSOR COMPLETE (COMP. TOP)	1	CWA50C2185	
26	HOLDER SENSOR	1	CWH321023	
27	V-COIL COMPLETE	1	CWA43C2168J	O
28	V-COIL COMPLETE (EXPAND VALVE)	1	CWA43C2058J	O
29	SENSOR COMPLETE (COMP. DISC.)	1	CWA50C2180	
30	SENSOR COMPLETE	1	CWA50C2181	
31	REACTOR	1	CWG0C203J00003	
32	CONTROL BOARD CASING (SIDE)	1	CWH102273	
33	TERMINAL BOARD ASSY	1	CWA28K1110J	
34	FUSE HOLDERS	1	K3GB1PH00016	
35	FUSE	1	K5D303BBA002	
37	CONTROL BOARD CASING (BOTTOM)	1	CWH102282	
38	ELECTRONIC CONTROLLER - MAIN	1	CWA73C3420R	O
40	CONTROL BOARD CASING (TOP)	1	CWH131167	
41	CABINET SIDE PLATE (LEFT)	1	CWE041255A	
42	HANDLE	1	CWE161010	
43	CABINET SIDE PLATE (RIGHT)	1	CWE041158A	
44	HANDLE	2	CWE16000E	
45	CABINET SIDE PLATE ASSY	1	CWE06K1043	
46	WIRE NET	1	CWD041041A	
47	CABINET TOP PLATE	1	CWE031031A	
48	CONTROL BOARD COVER (BOTTOM)	1	CWH131168	
49	CONTROL BOARD COVER (TOP)	1	CWH131169A	
50	RECEIVER	1	CWB14011	
53	ACCUMULATOR	1	CWB131024	
56	DRAIN HOSE	1	CWH5850080	
57	PACKING	1	CWB81012	
58	SOUND PROOF MATERIAL	1	CWG302270	
59	SOUND PROOF MATERIAL	1	CWG302300	
60	CRANKCASE HEATER	1	CWA341039	

(Note)

- All parts are supplied from PHAAM, Malaysia (Vendor Code: 061).
- "O" maked parts are recommended to be kept in stock.