

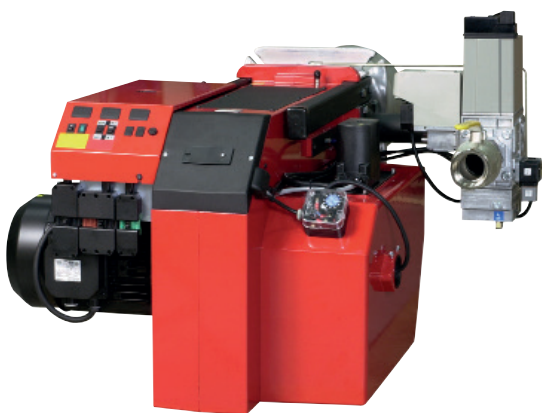

Providing sustainable energy solutions worldwide

Bentone BG700-BG800



Reservdelar och tillbehör
Spare parts and accessories
Ersatzteile und Zubehör
Pièces détachées et accessoires

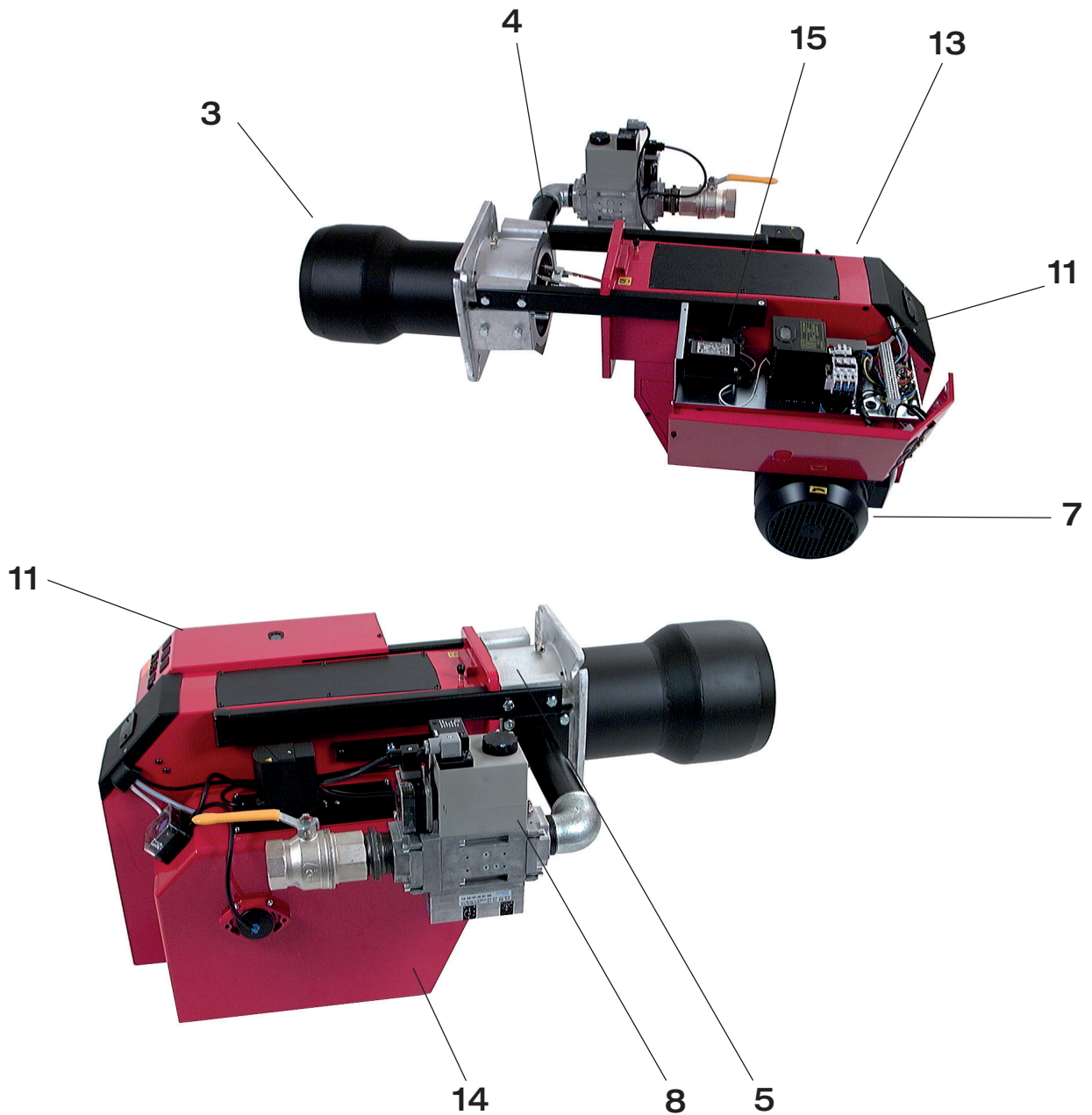

Brännarrör • Blast tube • Brennerrohr • Tube diffuseur.....	3
Anslutningsfläns • Fixing flange • Anschlussflansch • Bridge de fixation.....	4
Insats • Nozzle Assembly • Düsenstock • Ligne Porte-Gicleur.....	5
Transformator • Transformer • Transformator • Transformateur.....	6
Motor • Motor • Motor • Moteur	7
Gaskomponenter • Gas components • Gaskomponenten • Composants de gaz.....	8
Eldningsautomat • Burner control • Feuerungsautomat • Contrôle du brûleur	12
Fläkthus • Fan housing • Brennergehäuse • Carter du rotor.....	14
Luftreglering • Air regulation • Luftregelung • Régularisation à air	15
LMV BG700 - BG800	16



Brännarrör

Burner tube

Brennerrohr

Tube diffuseur

BG700

363 mm

663 mm

11919401

11919402



Brännarrör

Burner tube

Brennerrohr

Tube diffuseur

BG800





396 mm

696 mm







11919501







11919502



Anslutningsfläns • Fixing flange • Anschlussflansch • Bride de fixation

	Anslutningsfläns kpl	Fixing flange cpl	Anschlussflansch kpl	Bride de fixation cpl	91914601
	Styckförpackning	Single pack	Einzelverpackung	Seul paquet	11914601
	Gejder	Guide bars	Führungsstangen	Barres de guidage	1191420105
	Packing fläkthusfläns, plåt	Gasket fan housingflange, metal	Dichtung Brennergehäuse-Flansch, Blech	Joint carter du rotorbride, lame	11922601
	Packing fläkthusfläns,	Gasket fan housingflange,	Dichtung Brennergehäuse-Flansch	Joint carter du rotorbride	11915201
	Packing	Gasket	Dichtung	Joint	11278807







	Insats BG700 BG800	Inner assembly	Gasdüsenstock	Ligne portegicleur	11950301 11950201
	förlängt utf BG700 BG800	lengthened design	verlängte Ausf.	modèle allongée	11950302 11950202
	Insatsrör BG700 BG800	Tube	Rohr	Tube	11913401 11913701
	förlängt utf BG700 BG800	lengthened design	verlängte Ausf.	modèle allongée	11913402 11913702
	Tändeledrod	Ignition electrode	Zündeledrod	Electrode d'allumage	91865501
	Ämne	Workpiece	Werkstück	Forme à usiner	11534600
	Joniseringsledrod	Ionisation electrode	Ioniseringsledrod	Electrode d'ionisation	91837301
	Ämne	Workpiece	Werkstück	Forme à usiner	11837300
	Bromsskiva BG700 t.o.m seriennummer 2495721	Brake plate Even serial number 2495721	Stauscheibe Auch Seriennummer 2495721	Disque accroche flamme Même numéro de série 2495721	11473524
	Bromsskiva BG700 fr.o.m seriennummer 2495722	from the serial number 2495722	von der Seriennummer 2495722	à partir du numéro de série 2495722	91473533
	Bromsskiva BG800	Brake plate	Stauscheibe	Disque accroche flamme	91473525

	O-ring 81,92 x 5,34 72,39 x 5,33	O-ring	O-Ring	O-ring	11316843 11316850
	Bussning stödrulle	Bushing, backing roller	Buchse, Stützrolle	Douille, stabilisateur	11828501
	Klammer	Bracket	Klammer	Crampon	11009903
	Mät nipple	Test nipple	Messnippel	Raccord de mesure	11805301
	Transformator	Transformer	Transformator	Transformateur	11852303
	med kabel	with cable	mit Kabel	avec Câble	91852303
	Tändkabelsats	Ignition Cable Kit	Zündleitungssatz	Kit de fils d'allumage	12026304
	Isolator	Insulator	Isolator	Isolant	11924201
	Tänd/ Joniseringskabel 150mm	Ignition/ ionisation cable	Zünd/ Jonisationskabel	Câble d'allumage/ ionisation	12074815
	Resistanständkabel 250mm	Ignitioncable	Zündkabel	Câble H.T.	12074925
	Resistanständkabel 450mm	Ignitioncable	Zündkabel	Câble H.T.	12074945
	Resistanständkabel 500mm	Ignitioncable	Zündkabel	Câble H.T.	12074950
Resistanständkabel 550mm	Ignitioncable	Zündkabel	Câble H.T.	12074955	

	Joniseringskabel-sats	Ignition Cable Kit	Zündleitungssatz	Kit de fils d'allumage	12026314
	Isolator	Insulator	Isolator	Isolant	11924201
	Tänd/ Joniseringskabel 150mm	Ignition/ ionisation cable	Zünd/ Jonisationskabel	Câble d'allumage/ ionisation	12074815
	Resistanständkabel 250mm	Ignitioncable	Zündkabel	Câble H.T.	12074925
	Resistanständkabel 550mm	Ignitioncable	Zündkabel	Câble H.T.	12074955
	Joniseringskabel hona/hane, 500mm	Ignitioncable	Jonisationskabel Buchse / Stecker	Câble ionisation	12118150
	Joniseringskabel hona, 400 mm	Ignitioncable	Jonisationskabel Buchse	Câble ionisation	11865804
	Motor 3.0/3,6kW 50/60Hz 3F IP55 230/400V BG700	Motor	Motor	Moteur	12115401
	Motor 5.5/6.6kW 50/60Hz 3F IP55 230/400V BG800	Motor	Motor	Moteur	12115501
	Fläkthjul BG700 250 x 92 x 28	Fan wheel	Gebläserad	Rotor	11277607
	BG800 280 x 110				11277622
	Motorfläns	Flange, motor	Motorflansch	Bride, moteur	1190430105
	Avskärningskon BG700	Conical shield plate	Abschirmkonus	Cône deflecteur d'air	11914401
	Avskärningskon BG800	Conical shield plate	Abschirmkonus	Cône deflecteur d'air	11906201







	Multiblock DMV-VEF 5080/11	Multi Bloc	Multi Bloc	Multi Bloc	11851110
	Multiblock MBDLE 415 420	Multi Bloc	Multi Bloc	Multi Bloc	12100801 12100901
	Multiblock MBVEF 412 415 420 425	Multi Bloc	Multi Bloc	Multi Bloc	11851104 11851138 11851139 11851137
	Multiblock MBZRDLE 415 420	Multi Bloc	Multi Bloc	Multi Bloc	11567173 11567174
	Multiblock SET 1.40 VDG20	Multi Bloc	Multi Bloc	Multi Bloc	12078401

	Restriktor. Biogas	Restriktor flow adjuster, Biogas	Drossle Flow-Einsteller, Biogas	Etranglement, biogaz	11996501
	Tryckregulator (biogas) FRS520 10-30 mbar	Pressure adjustment valve (biogas)	Druckreglerventil (Biogas)	Vanne de réglage de pression	11478045
	Fläns MB410-412 1 1/4"	Flange	Flansch	Bride	11566713
	Fläns MB410-412 1 1/4" med mätnippel	Flange with test nipple	Flansch mit messnippel	Bride avec connecteur de test	11566718
	Fläns MB415-420 1 1/2" plugg 2" plugg	Flange plugg plugg	Flansch Stecker Stecker	Bride fiche fiche	11899201 11899202
	Fläns MB425 2" plugg	Flange plugg	Flansch Stecker	Bride fiche	11899302
	Fläns Gas AGF 10.40 1 1/2" 10.50 2"	Flange	Flansch	Bride	12079640 12079650
	Impulsfläns MBVEF 412 D35 415 D43 420 D53 425 D55	Impulse flange	Impulsflansch	Bride d'impulsions	11968402 11968403 11968404 11968405
	Magnetventil MVD 220/5 SER02 DMV-DLE 525/11	Solenoid	Magnetventil	Electrovanne	11984503 11979805







	Tätthetskontroll VPS504 S02	Leakage control	Dichtkontrolle	Controle d'étanchéité	11861701			
	Spjällmotor SQN13 med kabel 1,8 m	Damper motor with cable	Stellmotor mit Kabel	Servomoteur avec câble	92101801			
	Tryckvakt GW50A5, 5-50mbar	Pressure limiter	Druckwächter	Limiteur de pression	11531926			
	GW50A6				11531929			
	GW150A5 10-150mbar				11531927			
	UB50/A2 max 500bar				11531928			
	QPL15.150 gas				12079704			
	Mät nipple R 1/8	Test nipple	Messnippel	Raccord de mesure	11542701			
	Nippel 2 x 2	Nipple	Nippel	Raccord	11463704			
	1/8 x inv G 1/8				internal thread	Innengewinde	filetage intérieur	11469301
	klk 1/8 x 1/8 klk				1/8 x 1/8	11225801		
	v-nippel 1/8 x G 1/8	v-nipple	V-Nippel	v-raccord	11225802 439085228			
	Impulsrör	Impulse tube	Impulsrohr	Tube d'impulsions				
	Fläkttryck	fan pressure	Gebälgedruck	pression ventilateur	12078232			
	Gastruck	gas pressure	Gasdruck	la pression du gaz	12078233			
	Eldstadtryck	furnace pressure	Ofendruck	pression four	12078231			
	Rörkoppling GE6-L 1/8 nippel	Screw pipe coupling nippel	Rohranschluss Nippel	Raccord de tuyau raccorde	11545101			









	Magnetventilsats, kontinuerlig fläkt	Solenoid Valve Kit, continuous fan	Magnetventil-Set, kontinuierliche Fan	Électrovanne Kit, ventilateur continue	11923001
	Impulsrör Ø6,0 x 1,0 fz	Impulse tube	Impulsrohr	Tube d'impulsions	
	240 mm 570 mm metervara	meter goods	meterware	merchandise de mètre	11973811 11973812 23107700
	Nippel, impulsrör	Nipple, Impulse tube	Nippel, Impulsrohr	Raccord, Tube d'impulsions	
	rak vinkel rör				11982201 11982301 11982401
	Förbindelserör	Connecting pipe	Verbindungsrohr	Tube de liaison	
	gas 1 1/2" 1 1/2" 210 1 1/2" 1 1/4" 2" 2" mätstos 2 1/2" 3"				11944220 11943201 11944201 11981801 11944401 11944420 11907320 11907020
	Gasfilter DUNGS	Gas filter	Gas-Filter	Filtre gaz	
	GF 520/1 2" GF 40080/3 DN80				11395416 11395418
	Gasspjäll				
	DMK 515/1,5" Ø32 DMK 520/2" Ø40				12102201 12102301
	Motorkabel SQN13.	Motor Cable,	Motor Kabel,	Moteur Câble,	12106801
	L = 1800				
	Kabel, gas tryckvakt	Cable, gas pressure limiter	Kabel, gas- drückwächter	Câble, limiteur de pression à gaz	11951106
	3 x 0,75 L = 1310 mm				
	Bussning	Bushing	Buchse	Douille	
	1/4 x 1/8 2 x 1 1/2				11533505 11533507

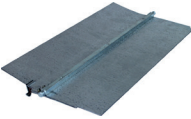



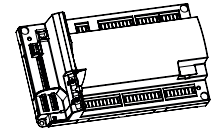

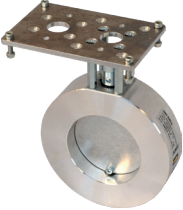

	O-ring 81,92 x 5,34	O-ring	O-Ring	O-ring	11316843
	Packningsplan DN80	Gasket	Dichtung	Joint	11524303
	Tätningring Tredo 1/4"	Gasket ring	Dichtungsring	Anneau d'étanchéité	11983301
	Anslutning för tryckvakt	Connection for Pressure limiter.	Anschluss für Druckwächter	Connexion pour limiteur de pression	11845301
	Adapter kpl VPS504-VDG20	Adapter cpl	Verschraubung kpl	Adaptateur cpl	11892003
	Planpackning Ø 19/13 x 2	Gasket	Dichtung	Joint	912375409
	Kulventil KSN75 3"	Ball valve	Kugelhahn	Vanne d'arrêt	11524602
	Reläbox LFL	Control box	Steuergerät Oberteil	Boite de contrôle	11463204
	Reläsocket LFL	Relay base	Steuergerät Unterteil	Socle de raccordement, boite de contrôle	11463300
	Kontaktдон hona 18309	Plug-in contact female 18309	Buchsenteil 18309	Fiche de prise de courant, femelle 18309	11421606
	Kontaktдон hona 183.2	Plug-in contact female 183.2	Buchsenteil 183.2	Fiche de prise de courant, femelle 183.2	11421604

	STYRAUTOMAT BP230UVFR-S2 B	Automatic control unit	Automatisches Steuergerät	Module de commande automatique	12124701
	FLAMDETEKTOR UV5-2	Flame detector	Flammenwächter	Détecteur de flamme	12124601
	Kontaktor 700	Contacteur	Kontaktor	Contacteur	12108101
	Kontaktor 800	Contacteur	Kontaktor	Contacteur	12108102
	Överströmsskydd 6-9,2 A	Thermal overload protection	Überstromschutz	Déclencheur à maxima d'intensité	
	700				12108205
	8-12 A 800				12108208
	Säkring 6,3 A	Fuse	Sicherung	Fusible	11333201
	Säkringshållare	Fuse holder	Sicherungshalter	Support de fusée	118 118 03
	Kontaktidon 7+4+5 pol	Plug-in contact 7+4+5-pole	Stecker und Buchse 7+4+5-polig	Fiche de Prise de courant 7+4+5-polaire	
	700-2				11909101
	700-M				11948612
	800-M				11948613
	7 pol, hane 7 pol, hona	male, 7-pole female, 7-pole	Stecker 7-polig Buchse 7-polig	mâle, 7-polaire femelle, 7-polaire	11558500 91558501
	4 pol, hane 4 pol, hona	male, 4-pole female, 4-pole	Stecker 4-polig Buchse 4-polig	mâle, 4-polaire femelle, 4-polaire	11919701 11919801
5 pol, hane 5 pol, hona	male, 5-pole female, 5-pole	Stecker 5-polig Buchse 5-polig	mâle, 5-polaire femelle, 5-polaire	11919901 11920001	
	Timräknare	Time meter	Betriebsstunden- zähler	Compteur horaire	11767801

	<p>Strömbrytare 0-I I - II man - auto</p>	<p>Switch</p>	<p>Schalter</p>	<p>Interrupteur</p>	<p>12014901 12014902 11784302</p>
	<p>Indikeringslampa grön</p>	<p>Indicating lamp green</p>	<p>Anzeigelampe grün</p>	<p>Lampe témoin verte</p>	<p>11721103</p>
	<p>Täckbricka</p>	<p>Covering plate</p>	<p>Deckplatte</p>	<p>Plaque de recouvrement</p>	<p>11721102</p>
	<p>Plugg</p>	<p>Covering plug</p>	<p>Stopfe</p>	<p>Tampon</p>	<p>11917201</p>
	<p>UV-cell QRA2</p>	<p>UV-detector</p>	<p>UV-Detektor</p>	<p>Cellule UV</p>	<p>91463401</p>
	<p>Lock</p>	<p>Cover</p>	<p>Deckel</p>	<p>Couvercle</p>	<p>1191500005</p>
	<p>Packning</p>	<p>Gasket</p>	<p>Dichtung</p>	<p>Joint</p>	<p>11915101</p>
	<p>Kåpa</p>	<p>Cover</p>	<p>Haube</p>	<p>Capot</p>	<p>1190660105</p>
	<p>Skyddsgaller</p>	<p>Protective grating</p>	<p>Schutzgitter</p>	<p>Grille protectrice</p>	<p>11904801</p>

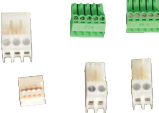
	Inspektionslock	Cover	Deckel	Couvercle	11708001
	Hjul	Bearing	Lager	Palier	11946201
	Lock	Cover	Deckel	Couvercle	11173101
	Packning	Gasket	Dichtung	Joint	11795301
	Inspektionsglas	Inspection glass	Schauglas	Viseur de flamme	11808801
	Säkringsring	Locking ring	Sicherungsring	Circlip	11801801
	Täckplåt kpl.	Covering plate cpl.	Deckplatte kpl.	Plaque de recouvrement cpl.	118 361 01
	Slangnippel	Hose nipple	Schlauchnippel	Raccord de tuyau flexible	11575301
	Nippel	Nipple	Nippel	Raccord	11542301
	Spjällmotor Kpl	Servo motor cpl.	Stellmotor	Servo moteur cpl.	
	SQN75.494A21B LFL 2-steg	SQN75.494A21B LFL 2-stage	SQN75.494A21B LFL 2-stufig	SQN75.494A21B LFL 2 allures	11942310
	SQN75.664A21B LFL modulerande	SQN75.664A21B LFL modulating	SQN75.664A21B LFL modulierend	SQN75.664A21B LFL modulant	11942305
	Fästplatta, spjällmotor	Covering plate, servo motor	Deckplatte, Stellmotor	Plaque de recouvrement, servo moteur	1191490105

	Pinnskruv, fästplatta	Stud screw, covering plate	Stiftschraube, Deckplatte	Vis à goupille, plaque de recouvrement	11920301
	Luftspjäll kpl.	Air damper compl	Luftklappe kompl.	Volet d'air compl.	11946301
	Länkarm kpl.	Slewing bracket cpl.	Gelenkarm kpl.	Pivot cpl.	11947001
LMV BG700 - BG800					
	Display AZL23	Display	Display	Display	12101101
	Displaykabel AZL L=186,4	Cable, Display	Kabel, Display	Cable, Display	12106301
	Styrautomat LMV37 ver.4 LMV37 ver.6	Relay	Steuergerät	Relay	12101004 12101006
	Effektvakt QPL25 LMV	Power monitor	Leistungs- überwachung	Surveillance de puissance	12079714
	Tryckvakt gas QPL25.150 bearb	Pressure limiter	Druckwächter	Limiteur de pression	12079724
	Gasspjäll DMK 5080-Q DUNGS 254019	Gas damper	Gasklappe	Amortisseur de gaz	12102502

	Gasspjäll DMK 5065-Q	Gas damper	Gasklappe	Amortisseur de gaz	12102402
	Impulsrör, regulator DN65-DN80 350 mm	Impulse tube	Impulsrohr	Tube d'impulsions	12104021
	Koppling, impulsrör Ø6xR1/4"	Coupling	Kupplung, Impulsrohr	Mamelon, Tube d'impulsions	
	Vinkel Rak	Angle Straight	Winkel Gerade	Coudé Tout droit	12105801 11545102
	Nycklade kontakter AGG3.132	Plug in contact AGG3.132	Stecker AGG3.132	Fiche de prise AGG3.132	12106200
	Kabel, Hirshmann	Cable, Hirshmann	Kabel, Hirshmann	Câble, Hirshmann	
	Magnetventil Gasvakt	Solenoid Valve Gas guard	Magnetventil Gaswächter	Électrovanne Garde de gaz	12106001 12106101
	Kabel, Luftrycksvakt	Cable, air pressure switch	Kabel, Luftdruckwächter	Câble, Pressostat air	12104401
	Tättningsring 1/4"	Sealing ring	Dichtungsring.	Anneau d'étanchéité.	11983301
	Spjällmotor SQN13 m kabel 1800mm Gas	Servo motor SQN13 cabel 1800mm Gas	Stellmotor SQN13 kabel 1800mm Gas	Servo moteur SQN13 Câble 1800mm Gaz	12101801
	Spjällmotor SQM33	Servo motor	Stellmotor	Moteur de volet	12101602
	Fästplatta, spjällmotor LMV	Covering plate, servo motor LMV	Deckplatte, Stellmotor LMV	Plaque de recouvrement, servo moteur LMV	1208850105





