

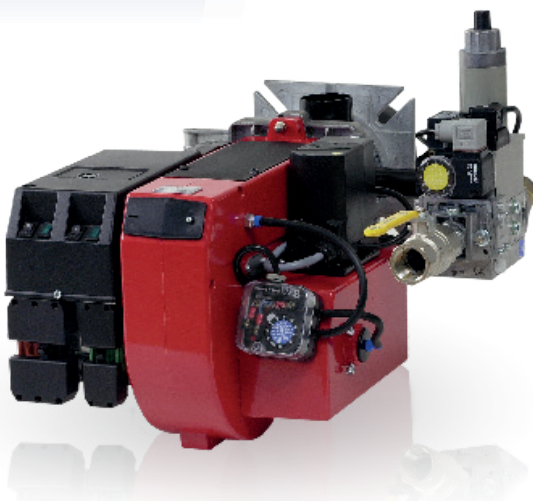

Providing sustainable energy solutions worldwide

Bentone BG 300-400



Reservdelar och tillbehör
Spare parts and accessories
Ersatzteile und Zubehör
Pièces détachées et accessoires

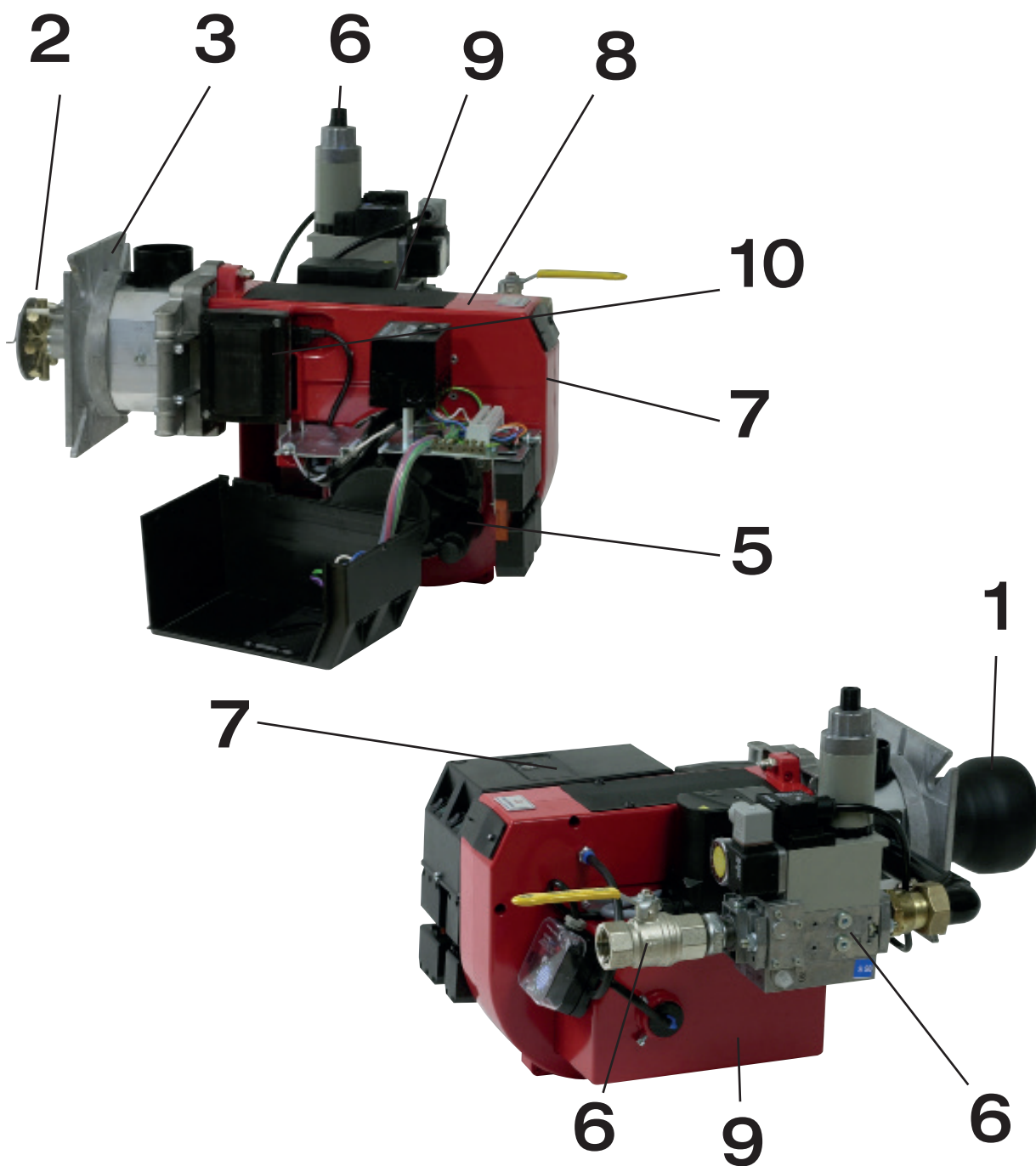

- | | |
|--|----|
| 1. Brännarrör - Blast tube - Brennerrohr - Tube diffuseur | 3 |
| 2. Insats • Nozzle Assembly • Düsenstock • Ligne Porte-Gicleur | 4 |
| 3. Anslutningsfläns • Fixing flange • Anschlussflansch • Bridge de fixation | 5 |
| 4. Motor • Motor • Motor • Moteur | 6 |
| 5. Gaskomponenter • Gas components • Gaskomponenten • Composants gaz | 7 |
| 6. Eldningsautomat • Gas burner control • Feuerungsautomat • Contrôle du brûleur | 12 |
| 7. Fläkthuset • Fan housing • Brennergehäuse • Carter du rotor | 14 |
| 8. Luftreglering • Air regulation • Luftregelung • Régularisation à air | 15 |
| 9. Transformator • Transformer • Transformator • Transformateur | 16 |

1. Brännarrör - Blast tube - Brennerrohr - Tube diffuseur



Brännarrör

Blast tube

Brennerrohr

Tube diffuseur

BG300

145 mm
245 mm

11751801
11751803



BG400

172 mm
272 mm
372 mm

11751901
11751903
11751904

2. Insats • Nozzle Assembly • Düsenstock • Ligne Porte-Gicleur

	Insats	Nozzle Assembly	Düsenstock	Ligne Porte-Gicleur	
	BG300 BG400				11804401 11804501
	Förlängt utf.	Lengthened design	Verlängerte Ausf	Allongée	
	BG300 BG400 BG400				11804403 11804503 11804504
	Bromsskiva med munstycke	Brake plate with nozzle	Stauscheibe mit Düse	Disque accroche-flamme avec Gicleur	
	BG300 BG400				11797002 11797001
	Bromsskiva	Brake plate	Stauscheibe	Disque accroche-flamme	
	BG300 BG400				11754401 11754402
	med nit	with rivet	mit Niet	avec rivet	
	BG300 BG400				91941801 91941802
	Munstycke	Nozzle	Düse	Gicleur	
	BG300 BG400				11796802 11796807
	Dragstång kpl.	Pull rod compl.	Zugstange kompl.	Tirant compl.	
	Förlängt utf.	Lengthened design	Verlängerte Ausf	Allongée	11930601 11930602 11930603
	Elektrodhållare	Electrode holder	Elektrodenhalter	Support d'électrode	
					11719601
	Elektrod	Electrode	Elektrode	Electrode	
	Jonisering förlängt utf.	Ionisation lengthened design	Ionisations verlängerte Ausf	d'ionisation allongée	11905102 11905106 11905110
	Tänd förlängt utf.	Ignition lengthened design	Zünd verlängerte Ausf	d'allumage allongée	
	L=388				11905101 11905105 11905109
	Klammer	Bracket	Klammer	Crampon	
	Förlängt utf.	lengthened design	verlängerte Ausf	allongée	11273801 0439017224
	O-ring, Nitril 25,2 x 3	O-ring, Nitrile	O-ring, Nitril	Rondelle, Nitrile	
	O-ring 23,52 x 1,78	O-ring	O-ring	Rondelle	11316838 11316801

3. Anslutningsfläns • Fixing flange • Anschlussflansch • Bridge de fixation



Flänspaket

Flange package

Flanschpaket

Jeu de bride

BG300
BG400

11752201
11752203

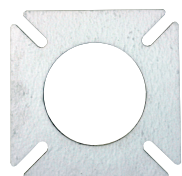

Packning

Gasket

Dichtung

Joint

11729701

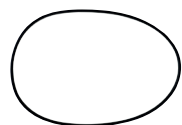

O-ring

O-ring

O-ring

Rondelle

11316829

134,5 x 3



Ratt







Knob

Drehknopf

Bouton

1172150105

4. Motor • Motor • Motor • Moteur

	Motor, 180W, 230V, 50/60Hz, 5uF, 1F BG300	Motor	Motor	Moteur	12090301
	med kabel	with cable	mit Kabel	avec Câble	92090301
	Motor, 250W, 230V, 50Hz, 8uF, 1F BG400	Motor	Motor	Moteur	12090201
	med kabel	with cable	mit Kabel	avec Câble	92090201
	Motor 350 W 60 Hz 1-fas BG400	Motor 350 W 60 Hz 1-phase BG400	Motor 350 W 60 Hz 1-phasig BG400	Moteur 350 W 60 Hz Monophasé BG400	12091201
	Fläkt hjul BG300 BG400 före 0014 BG400	Fan wheel before 0014	Gebläserad vor 0014	Rotor avant 0014	11277608 11277609 11277621
	Fläns BG300	Flange	Flansch	Bride	11700901
	Kondensator BG300 5µF BG400 8µF	Capacitor	Kondensator	Condensateur	12093101 12093201
	Kabel L = 435	Cable	Kabel	Câble	12086601

5. Gaskomponenter • Gas components • Gaskomponenten • Composants gaz

	Multiblock DMV-DLE BG300, BG400 Magnetventil DMV-DLE 512/11	Multi Bloc	Multi Bloc	Multi Bloc	11979802
	Multiblock GVC-15 BG400-2 *S*SR*SRD*PR	Multi Bloc	Multi Bloc	Multi Bloc	12075401
	Multiblock MBDLE BG300, BG400 407	Multi Bloc BG300, BG400 407	Multi Bloc BG300, BG400 407	Multi Bloc BG300, BG400 407	11567071
	Filter MBDLE 405/407 MBZRDLE 405/407 MBVEF 405/407	Filter	Filter	Filtre	11916411
	Multiblock MBDLE BG300, BG400 412 415 420	Multi Bloc	Multi Bloc	Multi Bloc	11567089 11979803 11567077
	Multiblock MBVEF BG300-M, BG400-M 407	Multi Bloc	Multi Bloc	Multi Bloc	11851102
	Multiblock MBVEF BG300-M, BG400-M 412	Multi Bloc	Multi Bloc	Multi Bloc	11851104

	Multiblock MBZRDLE BG400-2 BG300-2 407	Multi Bloc	Multi Bloc	Multi Bloc	11567171
	Multiblock MBZRDLE BG400-2 BG300-2 412 415	Multi Bloc	Multi Bloc	Multi Bloc	11567189 11567176
	Magnetventil BG400 1 1/2" ZRDLE 415/5	Solenoid valve	Magnetventil	électrovanne	11473203
	Magnetventil 1 1/2" MVD215/5 BG300 1" MVD 210/5	Solenoid valve	Magnetventil	électrovanne	11478205 11478204
	Magnetventil Biogas DMV 512/11 SV510RP1	Solenoid valve Biogas	Magnetventil Biogas	électrovanne Biogaz	11979803 12035003
	Magnetventil kontinuerlig fläkt	Solenoid valve continous fan	Magnetventil kontinuierliches Gebläse	électrovanne ventilation continue	11923001
	Kabel, magnetventil 3 x 0,75, L=800 3 x 0,75 L=530 steg 1 3 x 0,75 L=530 steg 2	Cable, solenoid valve stage 1 stage 2	Kabel, Magnetventil stufe 1 stufe 2	Câble, électrovanne 1 ère allure 2 ème allure	11951023 11951015 11951018
	Fläns 1/2" rak	Flange 1/2" straight	Flansch 1/2" gerade	Bride 1/2" droit	12049001
	Fläns 3/4" vinkel	Flange 3/4" Angle	Flansch 3/4" Winkel	Bride 3/4" Angle	11906808

	Fläns MB410-412 1 1/4"	Flange 1 1/4"	Flansch 1 1/4"	Bride 1 1/4"	11566703
	Fläns MB410-412 1 1/4" med mätnippel	Flange with test nipple	Flansch mit messnippel	Bride avec connecteur de test	11566718
	Fläns 1"	Flange 1"	Flansch 1"	Bride 1"	11566712
	Fläns 1" med mätnippel	Flange with test nipple	Flansch mit messnippel	Bride avec connecteur de test	11566717
	Fläns 1 1/2" med plugg	Flange with plug	Flansch mit Stecker	Bride avec fiche	11899201
	2" med plugg	with plug	mit Stecker	avec fiche	11899202
	1" DMV				11899205
	Impulsfläns MBVEF 407 MBVEF 412 MBVEF 415 MBVEF 420	Impulse flange	Impulsflansch	Bride d'impulsions	11968401 11968402 11968403 11968404
	Filter	Filter	Filter	Filtre	
	MB 405/407				11916401
	MB 410/412 MB 415/420				11916501 11916601
	Spole	Coil	Spule	Bobine	
	MB 405/407				
	steg 1	stage 1	stufe 1	1 ère allure	11568812
	steg 2	stage 2	stufe 2	2 ème allure	11568814
	MB 410/412/415				
	steg 1	stage 1	stufe 1	1 ère allure	11568813
steg 2	stage 2	stufe 2	2 ème allure	11568815	

	Tryckvakt	Pressure switch	Druckwächter	Pressostat	
	LGW50A2 2,5-50mbar				11531907
	GW150A5 10-150mbar				11531927
	GW50A5 5-50mbar				11531926
	GW150A6 med kontaktdon	with plug-in contact	mit Stecker und Buchsentteil	avec fiche de Prise de courant	91531930
	Kabel, tryckvakt	Cable, Pressure switch	Kabel, Druckwächter	Câble, Pressostat	
	3 x 0,75 L=590				11951113
	3 x 0,75 L=750				11951110
	4 x 0.75 L=600				11949704
	Tätthetskontroll	Valve, leak tester	Dichtkontrolle	Controle d'étanchéité	
	VPS504S02				11861701
	VPS504S504 (ersättning för VDK)	(replacement for VDK)	(ersatz für VDK)	(Remplacement de VDK)	11561802
	Effektvakt kpl	Power switch cpl	Leistungsbegrenzer kpl	Limiteur de puissance cpl	11950701
	ÜB50/A2				
	Gasfilter BG300 GF515/1	Gas filter	Gas-Filter	Filtre gaz	11395415
	BG400 GF520/1				11395416
	Restriktor, flödesjustering	Restrictor, flow regulation	Begrenzer, Flussregelung	Limiteur, réglage de flux	11996501
	Biogas	Biogas	Biogas	Biogaz	

Gaskomponenter • Gas components • Gaskomponenten • Composants gaz



Kulventil

Ball valve

Kugelhahn

Vanne d'arrêt

1"
1 1/2"

11396102
11396104



Förbindelserör

Connecting pipe

Gasrohr

Tube à gaz

3/4", 179,5 mm

1194300105

1", 179,5 mm

1198150105



Mät nipple

Test nipple

Messnippel

Raccord de mesure

11542701



Nippel

Nipple

Nippel

Raccord

1"
1 1/2"
3/4"-1"
1 1/2"-1 1/4"

11463702
11463703
11463705
11463708

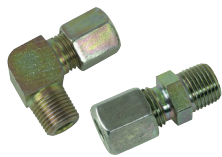

Rörkoppling

Screw pipe
coupling

Rohranschluss

Raccord de tuyau

Vinkel WE6-LLR
Rak GE6-LLR

Angel
Straight

Winkel
Gerade

Coude
Droit

11545201
11545101

6. Eldningsautomat • Gas burner control • Feuerungsautomat • Contrôle du brûleur



Bländare

Diaphragm

Blende

Diaphragme

10 mm
15 mm

11910201
11910202



Impulsrör

Impulse tube

Impulsrohr

Tube d'impulsions

23107700

Ø6,0x1,0 fz
metervara

meter goods

meterware

merchandise de
mètre



Reläbox

Control box

Steuergerät

Boîte de contrôle

11463204

LFL. 1.333E



Reläbox

Control box

Steuergerät

Boîte de contrôle

92070101

LME 21. 230C2E

LME11. 230C2E

92070001

LME22. 232C2E

92070201

LME22. 233

92070301



Reläsocket

Relay base

Unterteil

Socle

11463300

LFL 1.322



Reläsocket

Relay base

Unterteil

Socle

91559600



Kåpa

Cover

Haube

Capot

11807711



Förstärkare





Amplifier

Verstärker



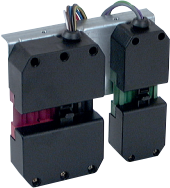





Amplificateur

AGQ1.2A27
LGB/UV







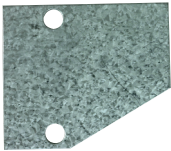

11898301

	Kontaktidon	Plug-in contact	Stecker und Buchsenteil	Fiche de prise de courant	11933301
	7-polig hane 7-polig hona	7-pole male 7-pole female	7-polig Stecker 7-polig Buchsenteil	7-pole mâle 7-pole femelle	11558500 91558501
	4-polig hane 4-polig hona	4-pole male 4-pole female	4-polig Stecker 4-polig Buchsenteil	4-pole mâle 4-pole femelle	11919701 11919801
	Timräknare	Time meter	Betriebsstundenzähler	Compteur horaire	11767801
	Indikeringslampa grön	Indicating lamp green	Anzeigelampe grün	Lampe témoin vert	11721103
	Strömbrytare	Switch	Schalter	Interrupteur	
	0-1 1-11				12014901 12014902
	Omkopplare	Switch	Umschalter	Commutateur	
	manuell-auto modulerande öka-minska,	manuel-auto, modulating increase-decrease,	manuell-auto, modulierend erhöhen-reduzieren,	manuel-auto, modulant augmenter-réduire,	12014903 11784302







7. Fläkthus • Fan housing • Brennergehäuse • Carter du rotor

	UV-cell QRA2	UV-detector	UV-Detektor	Cellule UV	91463401
	Täckbricka	Coverplate	Abdeckscheibe	Plaque de recouvrement	11789201
	Lock BG300 BG400	Cover	Deckel	Couvercle	1189260005 1189750105
	Lock, fotomotstånd BG300 Avklippt	Cover, photoresistor cut off	Deckel Fotowiderstand abschneiden	Couvercle, photorésistance couper	11173106
	Lock, fotomotstånd BG300	Cover, photoresistor	Deckel Fotowiderstand	Couvercle, photorésistance	11173101
	Packing	Gasket	Dichtung	Joint	11778301
	Inspektionslock	Inspection cover	Inspektionsdeckel	couvercle d'inspection	11708001
	Inspektionsglas	Inspection window	Sichtfenster	Hublot	11708101
	Packing, inspektionsglas	Gasket, inspection window	Dichtung, Sichtfenster	Joint, hublot	11778401

8. Luftreglering • Air regulation • Luftregelung • Régularisation à air

	Täckplåt BG300	Covering plate	Deckplatte	Plaque de recouvrement	11739101
	Täckbricka BG400	Covering plate	Deckplatte	Plaque de recouvrement	11788101
	Kabelskydd BG400	Cable protection	Kabelschutz	Protection de câble	11718503
	Luftreglering BG300 BG400	Air regulation	LuftEinstellung	Réglage d'air	91827501 91827502
	Spjällmotor SQN75.294A21B SQN75.664A21B SQN75.254A21B SQN75.624A21B	Damper motor	Stellmotor	Servo moteur	11942303 11942305 11942307 11942309
	Slangnippel	Hose nipple	Schlauchnippel	Raccord de tuyau flexible	11575301
	Slangnippel	Hose nipple	Schlauchnippel	Raccord de tuyau flexible	11562101
	Nippel	Nipple	Nippel	Raccord	11542301

9. Transformator • Transformer • Transformator • Transformateur

	Plugg	Plug	Stofe	Tampon	
	BG300 32 mm				11920912
	BG400 54 mm				11920911
	Transformator uv, biogas	Transformer uv, biogas	Transformator Uv, Biogas	Transformateur uv, biogaz	11804601
	kabel	cabl	Kabel	Câble	11804701
	Transformator,	Transformer ,	Transformator,	Transformateur,	11852303
	kabel	cabl	Kabel	Câble	11804702
	Kabel, Transformator	cabl, Transformer	Kabel, Transformator	Câble, Transformateur	11804701
	Tändkabel	Ignition cable	Zündkabel	Câble H.T.	
	350 mm 450 mm				12074935 12074945
	Joniseringskablar	Ionisation cables	Jonisationskabel	Câble d'ionisation	12026314
	Kabelgenomföring	Cable inlet	Kabel-durchführung	Douille de passage câble	04300401







