



Providing sustainable energy solutions worldwide



Bentone B1, B2

Reservdelar och tillbehör
Spare parts and accessories
Ersatzteile und Zubehör
Pièces détachées et accessoires

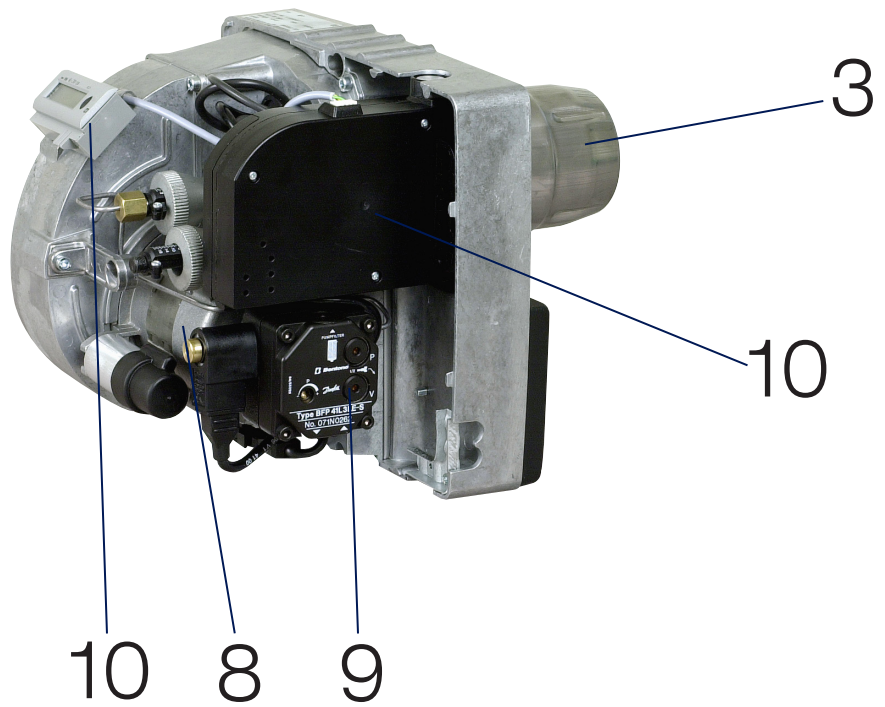
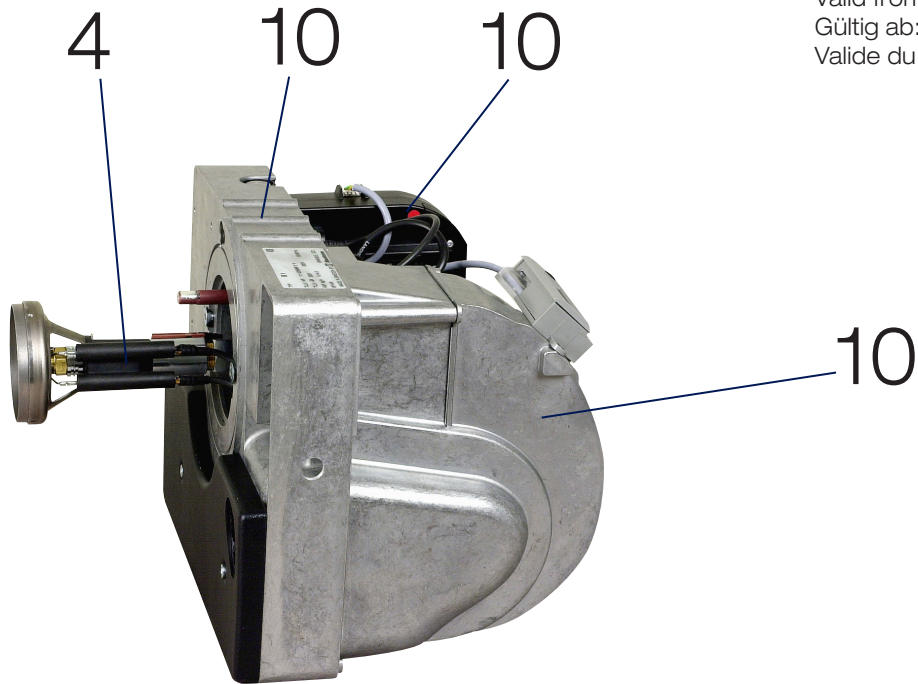

Gäller från:
Valid from:
Gültig ab:
Valide du:

Classic













1. Brännarrör • Blast tube • Brennerrohr • Tube diffuseur _____	3
2. Insats • Nozzle Assembly • Düsenstock • Ligne Porte-Gicleur _____	4
3. Anslutningsfläns • Fixing flange • Anschlussflansch • Bridge de fixation _____	6
4. Kåpa • Kåpa • Kåpa • Kåpa _____	7
5. Motor • Motor • Motor • Moteur _____	8
6. Pump • Pump • Pumpe • Pompe _____	9
7. El komponenter • Electric components • El komponenten • Composants électriques _____	10
8. Luftreglering • Air regulation • Luftregelung • Régularisation à air _____	11
9. Fläkthus • Fan housing • Brennergehäuse • Carter du rotor _____	12
10. Oljeslang • Flexible pipe • Ölschlauch • Flexible _____	13

1. Brännarrör • Blast tube • Brennerrohr • Tube diffuseur







	Brännarrör	Blast tube	Brennerrohr	Tube diffuseur	
	Prio Miljö, B1RL Ø64 131 mm				11951902
	Prio, B1RV Ø69 131 mm Ø69 181 mm				11951905 11951906
	Luftfördelare Prio, Prio Miljö	Air distributor	Luftverteiler	Repartiteur d'air	12020401
	B1				
	Brännarrör FU	Blast tube FU	Brennerrohr FU	Tube diffuseur FU	
	B1 FUV 103 mm 133 mm 183 mm				11764301 11764304 11764306
	Brännarrör	Blast tube	Brennerrohr	Tube diffuseur	
	B2SL Ø70 138 mm Ø70 188 mm				11952502 11952503
	B2S, B2SV Ø75 138 mm Ø75 188 mm				11952505 11952506
	Brännarrör	Blast tube	Brennerrohr	Tube diffuseur	
	B2KSV, B2KS, B2KSV LE Ø76 224 mm				11728411
	rostfritt Ø76 147mm				11728409
	Ombyggnadsatts	Conversion set	Umbausatz	Jeu de reconstruction	11900610
	PRIO - FUV				

2. Insats • Nozzle Assembly • Düsenstock • Ligne Porte-Gicleur



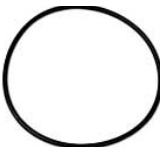

	Insats standard för brännarrör	Nozzle assembly standard design for burner tube	Düsenstock, standard für Brennerrohr	Ligne porte- gicleurstandard pour tube diffuseur	
	B1RV 131 mm 181 mm				11975541 11975542
	B2SV 138 mm 188 mm				11975543 11975544
	B2KSV 147 mm 197 mm				11975545 11975546
	B1 FUV 133 mm				11975555
	Insats, kallstart för brännarrör	Nozzle assembly, cold start for burner tube	Düsenstock, Kallstart für Brennerrohr	Ligne porte-gicleur, demurrage à froid pour tube diffuseur	
	B2S 138 mm 188 mm				11975521 11975522
	B2KS 147 mm 197 mm				11975524 11975525
	B1R 131 mm 181 mm				11975527 11975528
	B1 FU 133 mm				11975556
	Oljerör för brännarrör standard	Nozzle line for burner tube standard	Düsenrohr für Brennerrohr standard	Canne porte-gicleur pour tube diffuseur standard	
	131 - 147 mm 181 - 197 mm				11952201 11952202
	Oljerör för brännarrör Kallstart	Nozzle line for burner tube For cold start	Düsenrohr für Brennerrohr Für Kallstart	Canne porte-gicleur pour tube diffuseur Pour réchauffage	
	131 - 147 mm 181 - 197 mm				12021504 12021505

	Bromsskiva B1, Prio, Prio Miljö	Brake plate	Stauscheibe	Disque accroche- flamme	91975601
	Bromsskiva B2KS	Brake plate	Stauscheibe	Disque accroche- flamme	92026001
	Bromsskiva B2SL B2S, SV	Brake plate	Stauscheibe	Disque accroche- flamme	91984202 91984203
	Bromsskiva B1FU/FUV	Brake plate	Stauscheibe	Disque accroche- flamme	11591501
	Skruv, elektrodhållare B1FU/FUV	Screw, electrode holder	Schraube, Elektrodenhalter	Vis, porte-électrode	12022901
	Tändelektrod B1FU/FUV B2KS	Ignition electrode	Zündelektrode	Électrode d'allumage	11593701
	Fövärmare FPHB LE FPHB FPHD FPHD LE	Preheater	Vorwärmer	Réchauffeur	12086715 12086705 #11470608 #11470609
	O-ring, fövärmare	O-ring, preheater	O-ring, Vorwärmer	Joint torique, réchauffeur	11316802
	Skala, insatsinställning	Scale, nozzle assembly adjustment	Skala, Düsenstock- einstellung	Echelle, réglage de ligne porte-gicleur	11734601









3. Anslutningsfläns • Fixing flange • Anschlussflansch • Bride de fixation

	Kabel, förvärmare LMO 85	Cable, preheater LMO 85	Kabel, Vorwärmer LMO 85	Câble, réchauffeur LMO 85	11992102
	Kabel, förvärmare	Cable, preheater	Kabel, Vorwärmer	Câble, réchauffeur	11477706
	Ställratt	Adjustment screw	Stellschraube	Vis de reglage	12018301
	Anslutningsfläns	Fixing flange	Anschlussflansch	Bride de fixation	11811601
	Packning	Gasket	Dichtung	Joint	11819101
	Skruv, 8 x 65 upphängning B1	Screw,8X65 suspension	Schraube,8X65 Aufhängung	Vis 8X65, suspension	11412163
	O-ring 84,5 x 3	O-ring	O-ring	Joint torique	11316835











4. Kåpa • Kåpa • Kåpa • Kåpa

	Mellandel kpl. m skruv	Spacing piece compl. with screw	Zwischenteil kompl. mit Schraube	Pièce intermédiaire bride compl. avec vis	11851503
	För montering på CTC1200 Skruv 8X90	To be mounted on CTC1200 Screw 8X90	Für Montage am CTC1200 Schraube 8X90	Pour montage sur CTC1200 Vis 8X90	11412170
	B1				
	Pinnskruv med mutter	Stud bolt with nut	Stiftschraube mit Mutter	Prisonnier avec écrou	91951702
	B2				
	Kåpa Röd	Cover Red	Haube Rot	Capot Rouge	11953830
	B1				
	Kåpa Röd	Cover Red	Haube Rot	Capot Rouge	11971130
	B2				

5. Motor • Motor • Motor • Moteur

	Fäste B1 B2	Holder	Halter	Support	11789701 11789702
	Skruv	Screw	Schraube	Vis	11790001
	Motor,110 W 230V, 50/60Hz B1 med kabel	Motor	Motor	Moteur	12090601 92090601
	Motor 110 W 230V, 50/60Hz B2 med kabel	Motor	Motor	Moteur	12090901 92090901
	Fläkthjul B1 TLR 120 x 52 L-E B2 TLR 133 x 52 x 8	Fan wheel	Gebälserad	Rotor	11955701 117 27601
	Drivkoppling	Coupling	Kupplung	Accouplement	11756802
	Motorkabel	Motor cable	Motorkabel	Câble, moteur	12086601
	Kondensator 6,3uF	Capacitor	Kondensator	Condensateur	12093701
	Kondensator 4uF ACC	Capacitor	Kondensator	Condensateur	12093001







6. Pump • Pump • Pumpe • Pompe

	Pump BFP41L3	Pump	Pumpe	Pompe	
	Med kabel	With cable	Mit Kabel	Avec câble	92074001
	2-rörs	2-pipe	2-Rohr	2 tuyaux	
	Pump BFP41L3LE-S	Pump	Pumpe	Pompe	
	Med kabel	With cable	Mit Kabel	Avec câble	92074017
	2-rörs	2-pipe	2-Rohr	2 tuyaux	
	Förbindelserör	Connecting pipe	Öldruckrohr	Trompette	12007601
	Kabel, pump BFP41L3 BFP41L3LE-S	Cable, pump	Kabel, Pumpe	Câble, pompe	11597507 11992202
	Magnetventil BFP 41	Solenoid valve	Magnetventil	Électrovanne	11597303
	Spole, magnetventil BFP	Coil, solenoid valve	Spule, Magnetventil	Bobine, électrovanne	11597404
	Innerdel, BFP41L3 BFP41L3LE-S	Inner part	Einsatz	Partie intérieure	11774201 11774204
	Filterpatron BFP	Filter	Filter	Filtre	11774901
	Plugg BFP	Plug	Stöpsel	Cheville	11882201
	Packning, lock BFP	Gasket, cover	Dichtung, Deckel	Joint, couvercle	119 81001



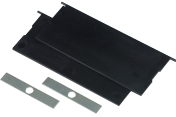



7. El komponenter • Electric components • El komponenten • Composants électriques

	Reläbox	Control box	Steuergerät	Boite de contrôle	
	LOA24 Styckförpackning	Single-piece package	Stückverpackung	Emallage par pièces	11559504 91559504
	LMO14 Styckförpackning	Single-piece package	Stückverpackung	Emallage par pièces	12000102 92000102
	Reläsockel	Base, control box	Unterteil, Steuergerät	Socle de raccordement	
	AGK 11 AGK 65				11559600 11559690
	Fotomotstånd QRB1B	Photoresistor	Fotowiderstand	Cellule photorésistante,	11992402
	Flamdetektor till brännare med LMO/LMV efter serienummer B1- 2499689 B2- 2499718	Flame detector for burners with LMO/LMV after serialnumber B1- 2499689 B2- 2499718	Flammendetektor für Brenner mit LMO/LMV nach der Seriennummer B1- 2499689 B2- 2499718	Détecteur de flamme pour les brûleurs avec LMO/LMV après le numéro de série B1- 2499689 B2- 2499718	12119641
	QRB4B-B036B40 L=250	QRB4B-B036B40 L=250	QRB4B-B036B40 L=250	QRB4B-B036B40 L=250	
	Kontaktдон hona 7-polig utan kåpa	Plug-in contact, female 7-pole without cover	Buchsenteil 7-polig ohne haube	Prise "européenne" femelle 7-polaire sans capot	11558606
	Kåpa	Cover	Haube	Capot	11558502
	Kontaktдон 7-pol hane	Plug-in contact, male 7-pole	Steckerteil 7-polig	Prise "européenne" mâle 7-polaire	11558500
	Transformator EBI	Transformer EBI	Transformator EBI	Transformateur EBI	12064301
	Med kabel	With cable	Mit Kabel	Avec Câble	92064301
	Kabel, transformator 400 mm	Cable, transformer 400 mm	Kabel, Transformator 400 mm	Câble, transformateur 400 mm	12062002





8. Luftreglering • Air regulation • Luftregelung • Régularisation à air

	Tändkabelpar 430 mm	Pair of ignition cable	Zündkabelpar	Câble d'allumage, paire	12068145
	Självstängande luftspjäll kpl. B1	Automatic air damper	Luftansaug- vorrichtung	Clapet d'air automatique	12018201
	Självstängande luftspjäll kpl. B2	Automatic air damper	Luftansaug- vorrichtung	Clapet d'air automatique	12018202
	Luftspjäll B1	Air damper	Luftklappe	Volet d'air	11977401
	Ställratt B1	Adjustment screw	Stellschraube	Vis de réglage	12018301
	Skala, luftinställning B1	Scale, air adjustment	Skala, LuftEinstellung	Echelle, réglage d'air	11734602
	Luftreglering B2	Air adjustment	LuftEinstellung	Réglage d'air	11901603

9. Fläkthus • Fan housing • Brennergehäuse • Carter du rotor

	Insugningsplatta B1	Suction plate	Ansaugplatte	Disque d'aspiration	11976101
	Isolering B1	Insulation	Isolierung	Isolation	12015101
	Isolering B1	Insulation	Isolierung	Isolation	12015201
	Isolering B1	Insulation	Isolierung	Isolation	12015301
	Plåt, ljuddämpare B1	Plate, silencer	Blech, Schalldämpfer	Tôle de silencieux	12015601
	Oljeslang L=900 DS1/4	Flexible pipe L=900 DS1/4	Ölschlauch L=900 DS1/4 L=900 DS1/4	Flexible L=900 DS1/4	12110002
	Oljeslang komp. med nipplar L=900	Flexible pipe complete with nipple L=900	Ölschlauch komplett mit Nipple L=900	Flexible complet avec raccord L=900	01760010
	Oljeslang L=900 Nippel G1/4x1/4 Nippel G1/4xR3/8 Nippel G1/4xR1/2 Kopparpackning	Flexible pipe L=900 nipple G1/4x1/4 nipple G1/4xR3/8 nipple G1/4xR1/2 Copper gasket	Ölschlauch L=900 Nipple G1/4x1/4 Nipple G1/4xR3/8 Nipple G1/4xR1/2 Kupferdichtung	Flexible L=900 raccord G1/4x1/4 raccord G1/4xR3/8 raccord G1/4xR1/2 Joint en cuivre	12110014 11757401 11246002 11246003 11021210

10. Oljeslang • Flexible pipe • Ölschlauch • Flexible

	<p>Oljeslang 1/4 700 mm 1/4 1000 mm 3/8 1000 mm</p>	Flexible pipe	Ölschlauch	Flexible	<p>11946501 11946502 11946503</p>
	Hållare, oljeslang	Bracket	Klammer	Crampon	11912201
	Nippel 1/4"x1/4"	Nipple	Nippel	Raccord	11757401
	Oljefilter, Bentone	Oil filter Bentone	Öfilter Bentone	Filtre d'huile Bentone	11932301
	Filterinsats Bentone	Filter Bentone	Filter Bentone	Filtre Bentone	11887701





